















Sospensioni, Lampade da soffitto, Lampade da parete,
Lampade da tavolo, Lampade da terra, Sistemi,
LED strip e supporti, Proiettori, Binari, Lampade da incasso,
Bollard, Lampadine, Accessori / Interno, Esterno / Minimal,
Decorativo, Architettuale /
Luce e design al servizio delle persone.

Light up your 2025.

ideal lux®

ideal lux.[®]

Indice		Indice alfabetico	004
		Indice icone	008
		Introduzione azienda	032
<hr/>			
Interni		Sospensioni	050
		Lampade da soffitto	236
		Lampade da parete	356
		Lampade da tavolo	448
		Lampade da terra	490
		Sistemi	536
		Led Strip e supporti	642
		Proiettori e binari	660
		Lampade da incasso	718
<hr/>			
Esterni		Sospensioni e soffitto	800
		Lampade da parete	814
		Bollard e lampade da tavolo	860
		Proiettori	912
		Incassi	928
<hr/>			
Lampadine		Lampadine e accessori	942
		Indice famiglie	962
		Indice per codice	978



Flam

Pag 80

Abc	99	Birds	473	Citrus	119
Acqua	903	Birds	497	Click	370
Admiral	347	Bistrò	184	Clio	806
Agos	882	Bit	930	Clio	856
Ali	387	Blanche	214	Clio	908
A-Line	125	Blossom	146	Clip	369
Alma	394	Blues	796	Cloud	284
Amadeus	219	Boa	171	Clown	160
Ampolla	116	Boeing	896	Cocktail	141
Andromeda	847	Bon Bon	231	Coco	181
Angolo	334	Bonne Nuit	406	Colonna	533
Angolo	476	Book	411	Colossal	216
Angolo	500	Bow	396	Comet	520
Apollo	832	Box	367	Cometa	852
Arca	612	Breeze	133	Comfort	512
Arcadia	881	Brigitta	229	Compo	343
Archimede	127	Bubble	812	Cono	138
Argo	845	Bubble	854	Copernico	110
Aria	152	Byte	696	Corolla	285
Arizona	156	Caesar	209	Corte	215
Arizona	278	Camerino	388	Corte	441
Armony	348	Canapa	235	Cosmo	907
Atena	900	Candy	158	Cosmopolitan	333
Atlas	332	Candy	280	Cotton	159
Atom	843	Candy	469	Cotton	281
Atrium	279	Cantina	137	Cover	364
Audi-10	186	Cantina	426	Craft	91
Audi-80	187	Carlton	203	Craft	374
Avion	177	Carlton	355	Craft	510
Axel	478	Carlton	439	Crown	66
Axel	526	Carta	170	Cube	370
Balance	371	Carta	282	Cute	868
Barber	415	Carta	385	Cylinder	190
Base	833	Carta	468	Cylinder	532
Basic	770	Carta	519	Daddy	524
Bean	402	Casanova	226	Dafne	857
Bento	728	Celine	270	Dafne	911
Bergen	183	Chalet	234	Daisy	342
Binomio	337	Chalet	444	Danieli	228
Binomio	429	Chalet	484	Dedra	859
Birds	105	Cima	857	Deep	768
Birds	327	Cima	910	Delta	372
Birds	421	Circus	75	Desk	90

Indice alfabetico

Desk	374	Equinoxe	499	Gas	823	Jazz	794	London	479
Deva	538	Eris	135	Gas	891	Jedi	894	London	529
Diamond	102	Essence	88	Gea	436	Justine	231	Look	78
Diamond	466	Essence	390	Geko	275	Kali	481	Look	300
Diesis	126	Etere	829	Gemini	60	Karma	150	Look	381
Diesis	459	Etere	904	Gemini	272	Karol	246	Look	506
Diesis	511	Eva	504	Gim	414	Karousel	92	Look	698
Display	700	Evasione	207	Ginger	515	Kelly	462	Lord	146
Dna	174	Fade	147	Gingle	274	Keope	832	Lounge	794
Dodo	414	Febe	858	Gioconda	224	Kepler	111	Lucciola	94
Doge	227	Felix	849	Gioconda	443	Kepler	422	Luce Max	161
Doris	876	Fiesta	813	Giove	848	King	200	Lugano	119
Dorsale	522	Filo	84	Glim	321	King	346	Lumiere	178
Down	858	Filo	392	Glim	695	Klimt	527	Lumiere	341
Dream Big	176	Filo	456	Glory	155	Koala	920	Lumiere	465
Driftwood	235	Filo	502	Glory	276	Komodo	408	Lumiere	496
Driftwood	484	Firenze	230	Goose	400	Konse	115	Luna	804
Driftwood	526	Firenze	444	Gourmet	331	Kubiko	306	Luna	878
Dubai	208	Firenze	485	Gravity	937	Kuky	139	Luxor	206
Dubai	353	Firenze	535	Gretel	185	Kurt	889	Madame	188
Dubai	439	Fisherman	136	Groove	776	Lana	153	Magnolia	353
Duchessa	487	Fix	366	Gru	454	Lana	298	Make-Up	395
Dynamic	734	Flam	80	Gun	810	Landing	938	Manhattan	142
Dynamite	96	Flash	380	Gun	834	Lawyer	464	Mapa	168
Dynamite	312	Floor	933	Halo	258	Leaves	112	Mapa	282
Dynamo	401	Florian	220	Harem	233	Led Panel	782	Mapa	384
Easy	458	Florian	442	Harem	446	Lena	153	Mapa	470
Easy	511	Fluo	626	Haunt	190	Level	276	Mapa Clear	166
Echo	376	Flut	143	Hermes	338	Lift	514	Mapa Max	161
Eclissi	433	Fly	248	Holly	128	Lika	311	Mapa Mini	164
Edison	120	Focus	398	Hotel	437	Lika	784	Mapa Plus	162
Edison	416	Folk	151	Hub	891	Linea	838	Maracas	330
Edo	475	Fox	678	Hulahoop	74	Lingotto	100	Maracas	424
Edo Outdoor	901	Frame	76	Ice	118	Lingotto	335	Marte	902
Ego	494	Frame	247	Igor	101	Lingotto	477	Martinez	202
Ego	558	Frame	501	Igor	420	Link 3-Phase	708	Martinez	354
Elio	820	Frida	120	Iko	840	Link 1-Phase	714	Medea	853
Elio	926	Frida	419	Indio	931	Linus	375	Mercurio	902
Empire	179	Funky	794	Inside	927	Linus	624	Metro	133
Enya	872	Futura	460	Io	399	Lite	405	Mib	812
Eos	686	Futura	514	Ipotesi	873	Litio	821	Mignon	467
Equinoxe	108	Galaxy	104	Iride	269	Litio	926	Milk	140
Equinoxe	425	Game	742	Itaca	880	Lolita	870	Millennium	210

Indice alfabetico

Minimal	418	Oak	310	Penta	431	Regol	528	Smarties	154
Minor	97	Oby	317	Perlage	106	Relax	268	Smarties	277
Mint	182	Oby	415	Perlage	324	Retrò	397	Smarties	385
Miracle	67	Ocean	270	Perlage	423	Rex-1	850	Smarties	469
Mirror-10	396	Octopus	329	Perlage	473	Rex-2	851	Smile	670
Mirror-20	397	Off	764	Perlage	498	Rex-3	851	Snif Round	830
Mix Up	130	Office	640	Perline	105	Rhapsody	93	Snif Square	831
Mix Up	290	Oil	122	Peter	445	Riflesso	395	Snow	805
Mix Up	508	Omega R.	819	Petit	314	Rocket	941	Snow	855
Moby	134	Omega S.	819	Piano	409	Rocket Mini	940	Soda	383
Monet	211	One	756	Ping Pong	336	Rocket Ultra M.	941	Soft	180
Mood	307	Onion	117	Ping Pong	428	Roma	344	Sole	802
Moonlight	351	Opera	198	Ping Pong	472	Roma	438	Sole	877
Moris	366	Opera	440	Ping Pong	505	Roma	486	Spike	308
Mouse	316	Opera	486	Pipe	404	Room-65	795	Spike	697
Mouse	412	Opera	534	Pivot	455	Rose	217	Spot	316
Mouse	694	Oracle	74	Planet	288	Royal	352	Spot	412
Mr Jack	121	Oracle Slim	68	Play	313	Rubik	842	Spot	694
Multiflex	328	Oracle Slim	242	Play	778	Rudy	318	Squish	271
Nabucco	204	Origami	144	Plissé	152	Rudy	413	Starlight	918
Napoleon	222	Ovalino	157	Polar	853	Sally	463	Steel	634
Negresco	218	Ovalino	284	Polka	797	Samba	792	Stick	598
Negresco	442	Ovalino	382	Polly	518	Santa	447	Strauss	225
Nemo	172	Oz	64	Pop	95	Sasso	879	Strauss	443
Net	114	Oz	244	Posta	368	Set Up	192	Style	826
Neve	350	Oz	362	Pouche	365	Set Up	292	Style	884
Newton	426	Oz	452	Pov	692	Set Up	434	Swan	199
Newton	516	O-Zone	818	Prato	474	Set Up	482	Swan	440
Ninfea	339	O-Zone	916	Pretty	388	Set Up	530	Swing	794
Ninfea	431	Page	403	Privè	389	Set Up Slim	194	Swipe	825
Ninfea	471	Pagoda	525	Probe	410	Set Up Slim	294	Tag	754
Nitro R.	302	Pan	191	Profilo	320	Set Up Ultra Slim	196	Tall	124
Nitro S.	304	Pan	430	Pulsar	903	Set Up Ultra Slim	296	Taurus	934
Nodi	175	Park	936	Punto	836	Shell	299	Techo	808
Nodi	322	Pashà	205	Pure	864	Shower	427	Terra	822
Nodino	323	Pashà	345	Quark	760	Simply	298	Terra	925
Nordik	189	Pashà	438	Queen	488	Sirio	841	Tesi	648
Nordik	436	Paul	382	Queen	534	Sirio	886	Tesla	890
Nordik	480	Pegaso	212	Quick	662	Sirio	924	Tetris-1	844
Nordik	532	Pegaso	441	Radio	417	Sky	83	Tetris-2	845
Norma	232	Pegaso	489	Rain	201	Sky	301	Theo	393
Nova	780	Peggy	365	Rain	352	Sky	381	Thor	914
Oak	82	Penta	340	Ray	260	Slot	652	Thor	932

Tick	432	Xeno	824
Tifone	892	Yoko	89
Titano	888	Yoko	457
Toby	313	Yoko	503
Toffee	837	York	527
Toffee	866	Yurta	132
Topico	148	Zephyr	798
Topico	283	Zeus	720
Torre	906	Zig Zag	378
Totem	268	Ziggy	286
Tower	310		
Triade	129		
Triplo	386		
Triumph	98		
Triumph	326		
Triumph	424		
Tronco	828		
Tronco	898		
Tube	82		
Tudor	387		
Twiggy	874		
Twin	846		
Ulex	922		
Ulisse	156		
Ultrathin	86		
Umile	145		
Universal R.	264		
Universal S.	266		
Up	844		
Urano	811		
Vanity	232		
Vega	893		
Virus	758		
V-Line	89		
Vortex	113		
Walky	799		
Wally	463		
Wally	517		
Waves	58		
Way	939		
Winery	315		
Winery	416		
Wire	930		

Led Strip and lightbulbs:

Strip Led	644
E14	944
E27	946
G4	954
G9	954
GX53	956
R7s	955
GU10	955



Ego

Pag 494













































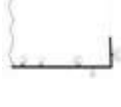





Waves

Pag 058

Indice icone

Sospensioni Interni

 new	 new	 new		 new	 new	
Waves 058	Gemini 060	Oz 064	Crown 066	Miracle 067	OracleSlim 068	Oracle 074
				 new		
Hulahoop 074	Circus 075	Frame 076	Look 078	Flam 080	Tube 082	Oak 082
	 new	 new	 new			 new
Sky 083	Filo 084	Ultrathin 086	Essence 088	Yoko 089	V-Line 089	Desk 090
						
Craft 091	Karousel 092	Rhapsody 093	Lucciola 094	Pop 095	Dynamite 096	Minor 097
				 new	 new	
Triumph 098	Abc 099	Lingotto 100	Igor 101	Diamond 102	Galaxy 104	Birds 105
		 new				
Perline 105	Perlage 106	Equinoxe 108	Copernico 110	Kepler 111	Leaves 112	Vortex 113
						
Net 114	Konse 115	Ampolla 116	Onion 117	Ice 118	Citrus 119	Lugano 119

Sospensioni

Interni



Frida 120



Edison 120



Mr Jack 121



Oil 122



Tall 124



A-Line 125



Diesis 126



Mix Up 130



Yurta 132



Metro 133



Breeze 133



Moby 134



Eris 135



Fisherman 136



Milk 140



Cocktail 141



Manhattan 142



Flut 143



Origami 144



Umile 145



Blossom 146

new



Karma 150



Folk 151



Aria 152



Plissé 152



Lana 153



Lena 153



Smarties 154



Ovalino 157



Candy 158



Cotton 159



Clown 160



Mapa Max 161



Mapa Plus 162



Luce Max 161



Carta 170



Boa 171



Nemo 172



Dna 174



Nodi 175



Dream Big 176



Avion 177



Coco 181



Mint 182



Bergen 183



Bistrò 184



Gretel 185



Audi-10 186



Audi-80 187



Haunt 190



Pan 191



Set Up 192



SetUp Slim 194



SetUp Ultra Slim 196



Opera 198



Swan 199

Fade

Pag 147



Archimede 127



Holly 128



Triade 129



Cantina 137

new



Cono 138



Kuky 139



Lord 146



Fade 147

new



Topico 148



Glory 155



Ulisse 156



Arizona 156

new



Mapa Mini 164



Mapa 168

new



Mapa Clear 169



Lumiere 178



Empire 179



Soft 180



Madame 188



Nordik 189



Cylinder 190



King 200



Rain 201



Martinez 202





Casanova

Pag 226



Carlton 203



Nabucco 204



Pegaso 212



Blanche 214



Gioconda 224



Strauss 225



Vanity 232



Norma 232

Sospensioni

Interni



Pashà 205



Luxor 206



Evasione 207



Dubai 208



Caesar 209



Millennium 210



Monet 211



Corte 215



Colossal 216



Rose 217



Negresco 218



Amadeus 219



Florian 220



Napoleon 222



Casanova 226



Doge 227



Danieli 228



Brigitta 229



Firenze 230



Justine 231



Bon Bon 231



Harem 233



Chalet 234



























































Canapa 235



Driftwood 235

Lampade da soffitto

Interni

<small>new</small> 	<small>new</small> 		<small>new</small> 	<small>new</small> 		
Oracle Slim 242	Oz 244	Karol 246	Frame 247	Fly 248	Halo 258	Ray 260
					<small>new</small> 	<small>new</small> 
Relax 268	Totem 268	Iride 269	Celine 270	Ocean 270	Squish 271	Gemini 272
						
Glory 276	Level 276	Smarties 277	Arizona 278	Atrium 279	Candy 280	Cotton 281
<small>new</small> 						
Topico 283	Ovalino 284	Cloud 284	Corolla 285	Ziggy 286	Planet 288	Mix Up 290
<small>new</small> 						<small>new</small> 
SetUpUltraSlim 296	Simply 298	Lana 298	Shell 299	Look 300	Sky 301	Nitro Round 302
	<small>new</small> 					
Mood 307	Spike 308	Oak 310	Tower 310	Lika 311	Dynamite 312	Play 313
						
Winery 315	Mouse 316	Spot 316	Oby 317	Rudy 318	Profilo 320	Glim 321
						
Perlage 324	Triumph 326	Birds 327	Multiflex 328	Octopus 329	Maracas 330	Gourmet 331

new



Universal R. 264

new



Universal S. 266



Gingle 274



Geko 275



Mapa 282



Carta 282



Set Up 292

new



SetUp Slim 294



Nitro Square 304



Kubiko 306



Toby 313



Petit 314



Nodi 322



Nodino 323



Atlas 332



Cosmopolitan 333



Squish

Pag 271

Nitro

Pag 302



Lampade da soffitto

Interni



Angolo 334



Lingotto 335



Ping Pong 336



Binomio 337



Hermes 338



Ninfea 339



Penta 340



Lumiere 341



Daisy 342



Compo 343



Roma 344



Pashà 345



King 346



Admiral 347



Armony 348



Neve 350



Moonlight 351



Royal 352



Rain 352



Magnolia 353



Dubai 353



Martinez 354



Carlton 355

Bonne Nuit

Pag 406



new



Oz 362



Cover 364



Click 370



Cube 370



FlashGesso 380



Sky 381



Tripla 386



Ali 387



Alma 394



Make Up 395



Goose 400



Dynamo 401



Probe 410



Book 411



























































Winery 416



Edison 416





























Lampade da parete

Interni

						
Peggy 365	Pouche 365	Fix 366	Moris 366	Box 367	Posta 368	Clip 369
						
Balance 371	Delta 372	Desk 374	Craft 374	Linus 375	Echo 376	Zig Zag 378
						
Look 381	Paul 382	Ovalino 382	Soda 383	Mapa 384	Smarties 385	Carta 385
						
Tudor 387	Camerino 388	Pretty 388	Privè 389	Essence 390	Filo 392	Theo 393
						
Riflesso 395	Bow 396	Mirror-10 396	Mirror-20 397	Retrò 397	Focus 398	IO 399
						
Bean 402	Page 403	Pipe 404	Lite 405	Bonne Nuit 406	Komodo 408	Piano 409
						
Mouse 412	Spot 412	Rudy 413	Gim 414	Dodo 414	Oby 415	Barber 415
						
Radio 417	Minimal 418	Frida 419	Igor 420	Birds 421	Kepler 422	Perlage 423

Lampade da parete

Interni

		 <small>new</small>				 <small>new</small>
Triumph 424	Maracas 424	Equinox 425	Cantina 426	Newton 426	Shower 427	Ping Pong 428
	 <small>new</small>					
Penta 431	Ninfea 431	Tick 432	Eclissi 433	Set Up 434	Nordik 436	Gea 436
						
Pashà 438	Carlton 439	Dubai 439	Opera 440	Swan 440	Corte 441	Pegaso 441
						
Gioconda 443	Strauss 443	Firenze 444	Chalet 444	Peter 445	Harem 446	Santa 447



Binomio 429



Pan 430



Hotel 437



Roma 438



Negresco 442



Florian 442





Ninfea

Pag 471

Lampade da tavolo

Interni

new



Oz 452



Gru 454



Pivot 455



Filo 456



Yoko 457



Easy 458



Diesis 459



Futura 460



Kelly 462



Sally 463



Wally 463



Lawyer 464



Lumiere 465

new



Diamond 466

new



Mignon 467



Carta 468



Smarties 469



Candy 469



Mapa 470

new



Ninfea 471



Ping Pong 472



Birds 473



Perlage 473



Prato 474



Edo 475



Angolo 476



Lingotto 477



Axel 478



London 479



Nordik 480



Kali 481



Set Up 482



Driftwood 484



Chalet 484



Firenze 485



Roma 486



Opera 486



Duchessa 487



Queen 488



Pegaso 489

Lampade da terra

Interni

new



Ego 494



Lumiere 496



Birds 497



Perlage 498

new



Equinoxe 499



Angolo 500



Frame 501



Look 506



Mix Up 508

new



Craft 510



Easy 511



Diesis 511

new



Comfort 512



Lift 514



Polly 518



Carta 519



Comet 520



Dorsale 522



Daddy 524



Klimt 527



Regol 528



London 529



Set Up 530



Cylinder 532



Nordik 532



Colonna 533

new



Filo 502



Yoko 503



Eva 504



Ping Pong 505



Futura 514



Ginger 515

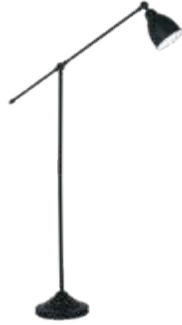

Newton 516



Wally 517



Pagoda 525



Axel 526



Driftwood 526



York 527



Opera 534



Queen 534



Firenze 535

Diesis

Pag 511



Sistemi

Interni



Deva 538

Ego 558

Stick 598

Arca 612

Linus 624



Fluo 626

Steel 634

Office 640

LED strip e supporti



Strip 644

Tesi 648

Slot 652

Proiettori e binari



Quick 662

Smile 670

Fox 678

Eos 686

Pov 692



Mouse 694

Spot 694

Glim 695

Byte 696

Spike 697



Look 698

Display 700

Link 3-Phase 708

Link 1-Phase 714

Lampade da incasso



Zeus 720



Bento 728



Dynamic 734

new



Game 742

new



Tag 754



One 756



Virus 758

new



Quark 760



Off 764



Deep 768



Basic 770



Groove 776

new



Play 778



Nova 780



Led Panel 782

new



Lika 784



Samba 792



Jazz 794



Swing 794



Lounge 794



Funky 794



Room-65 795



Blues 796



Polka 797

new



Zephyr 798



Walky 799

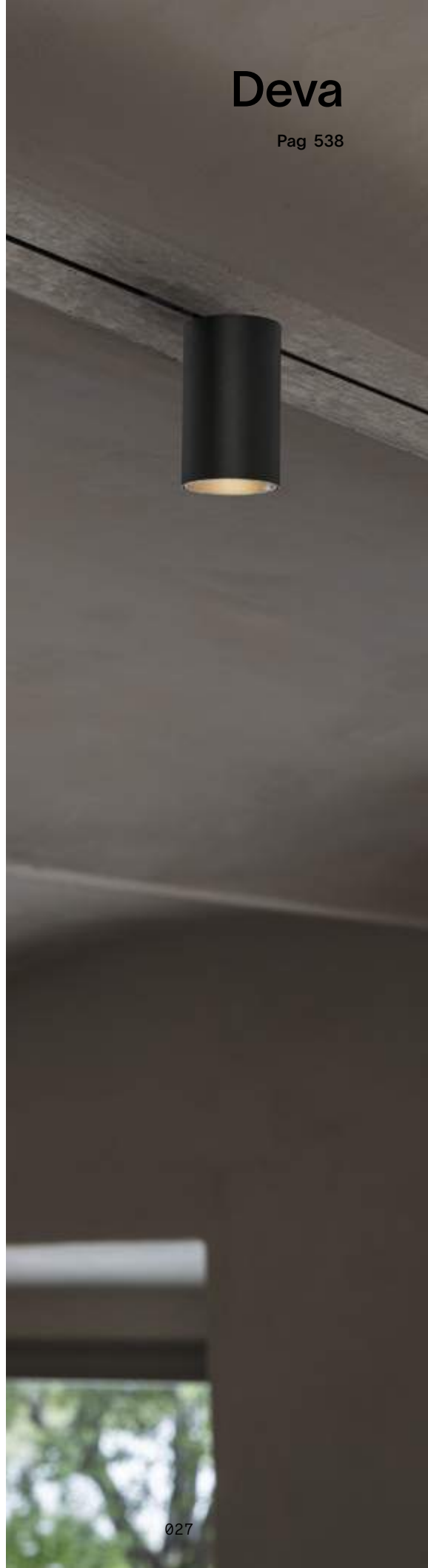

Snow

Pag 855



Sospensioni e soffitto

new



Sole 802



Luna 804

new



Snow 805



Clio 806



Clio 806



Clio 806



Clio 806



Clio 806



Clio 806

new



Techo 808



Gun 810



Urano 811



Bubble 812



Mib 812



Fiesta 813

Lampade da parete

Esterni

new



O-zone 818



Omega R. 819



Omega S. 819



Elio 820



Litio 821



Terra 822



Gas 823



Xeno 824



Swipe 825



Style 826



Tronco 828



Etere 829



Snif Round 830



Snif Square 831



Keope 832



Apollo 832



Base 833



Gun 834



Punto 836

new



Toffee 837



Linea 838

new



Iko 840



Sirio 841



Rubik 842



Atom 843



Up 844



Tetris-1 844



Tetris-2 845



Argo 845



Twin 846



Andromeda 847



Giove 848



Felix 849



Rex-1 850



Rex-2 851



Rex-3 851



Cometa 852



Polar 853



Medea 853



Bubble 854

new



Snow 855



Clio 856



Clio 856



Clio 856



Cima 857



Dafne 857



Down 858



Febe 858



Dedra 859

Bollard e lampade da tavolo

Esterni



Pure 864



Toffee 866

new



Cute 868



Lolita 870

new



Enya 872



Ipotesi 873

new



Twiggy 874



Doris 876



Sole 877



Luna 878



Sasso 879



Itaca 880



Arcadia 881



Agos 882



Style 884



Sirio 886



Titano 888



Kurt 889



Tesla 890



Gas 891



Hub 891



Tifone 892



Vega 893



Jedi 894

new



Boeing 896



Tronco 898



Atena 900



Edo Outdoor 901



Marte 902



Mercurio 902



Pulsar 903



Acqua 903



Etere 904



Torre 906



Cosmo 907



Clio 908



Clio 908



Clio 908



Cima 910



Dafne 911

Proiettori

new



Thor 914

new



O-zone 916

new



Starlight 918

new



Koala 920



Ulex 922



Sirio 924



Terra 925



Elio 926



Litio 926



Inside 927

Incassi



Bit 930



Wire 930



Indio 931

new



Thor 932



Floor 933



Taurus 934



Park 936



Gravity 937



Landing 938



Way 939



Rocket Mini 940



Rocket 941

new



Rocket Ultramini 941

Ipotesi

Pag 873



“C'è un gesto quotidiano
che ognuno di noi compie
al sopraggiungere del buio.
Un rito familiare che
rappresenta gioia, sicurezza,
momento dedicato allo
stare insieme.

**Accendere una luce è
un'azione semplice,
ma carica di significati.
Da qui inizia la nostra storia.”**





ideal

Light up your moments

Ideal lux **si impegna ogni giorno per diventare** il punto di riferimento nella scelta di una lampada che esprima la propria personalità attraverso un complemento d'arredo unico e attuale.

Tutto nasce nel 1974, dall'intuizione di ideare complementi d'arredo illuminotecnici attuali e accessibili. Da allora, ideal lux si impegna ad ascoltare le necessità di tutti, proponendo un'ampissima varietà di stili di illuminazione e **venendo incontro** a ogni esigenza funzionale. Che sia una famiglia, un'attività commerciale o una persona all'inizio

della sua avventura in una nuova casa, ideal lux promette **componenti all'altezza di esigenze e sogni.**

Il punto di forza, irrinunciabile quando si parla di vicinanza tra azienda e persone, è un catalogo che va incontro a qualunque tipo di esigenza: **più di 3.000 complementi d'arredo** che spaziano tra tantissime linee prodotte, dai complementi da interno ed esterno, fino ad arrivare a quelli più tecnici.



Giving shape to light

Quando si parla di soluzioni da interno, l'obiettivo di ideal lux è quello di **creare scenografie** versatili per tutti gli ambienti, lasciando **vivere ogni momento** con la giusta atmosfera e offrendo a tutti la possibilità di **sperimentare con la propria idea di casa**. Anche fuori, le soluzioni proposte per gli spazi esterni non rinunciano a estetica e sicurezza, restando un piacevole **elemento di design** anche nei momenti in cui si ha bisogno di un po' d'aria.

Per gli spazi professionali, che richiedono **un'attenzione tecnica particolare**, ideal lux ha pensato di lavorare su tantissime proposte che aiutano a distribuire la luce nella giusta direzione dando maggiore

resa ai colori, senza mai perdere di vista il design e **rendendo unici** anche gli spazi in cui si creano relazioni professionali.

Ma se da una parte garantire la scelta e proporre un catalogo vasto costituisce un obiettivo commerciale molto importante, dall'altra, anche **la relazione con i clienti** è un aspetto che ideal lux coltiva con meticolosa cura. Come lo fa? Assicurando la possibilità di acquistare un prodotto di design, aggiornato alle tendenze più attuali e, soprattutto, accessibile a tutti. Che lo stile preferito sia industrial, minimal, classico, contemporaneo, moderno o eclettico... chiunque lo desideri può **entrare nel mondo ideal lux**.







ideal lux

111 112





Studio Impero
Rome, RM
Planned out by ARCH.0



Studio Impero
Rome, RM
Planned out by ARCH.0

Per ideal lux una lampada è molto più di un oggetto. L'illuminazione ha il potere di **influenzare la quotidianità**, donando **carattere e personalità uniche agli ambienti**. Per questo, ogni giorno ideal lux si impegna ad ascoltare le persone e le loro storie, con l'obiettivo di coltivare un **rapporto autentico e spontaneo**, e trovando nel racconto nuovi punti di vista, nuove ispirazioni.

Il **Customer Care** costituisce un ramo importante dell'azienda, distinguendosi per la cura e per l'attenzione che dedica ai clienti e facendo dell'affidabilità

uno dei principi più importanti. **L'attenzione per le persone è centrale**. Con ideal lux la luce diventa quell'elemento della quotidianità capace di **trasformare l'ordinario in straordinario**. Perché accada, è importante scegliere l'illuminazione adatta alle proprie esigenze, perché con la luce giusta ogni ambiente può assumere **tutta un'altra forma, un'altra storia**.

The ordinary is extraordinary

Un brand, tante persone.

Crederci nelle persone è una scelta che facciamo ogni giorno. Valorizziamo i dipendenti, crescendo giorno dopo giorno assieme a loro, e costruiamo relazioni durature e trasparenti con clienti e fornitori.

Saper ascoltare.

Ci impegniamo a comprendere le necessità e i sogni dei clienti e a trasformare le difficoltà in occasioni, con l'obiettivo di migliorare costantemente in questa direzione.

Non c'è qualità senza garanzia.

Abbiamo esteso la garanzia di tutti i nostri complementi illuminotecnici a 5 anni, per assicurare in ogni momento una qualità elevata di prodotto e servizio.

**Il design
alla portata
di tutti.**

Vogliamo far entrare il design nella quotidianità delle persone, con soluzioni luminose esteticamente belle e funzionali, ma a costi contenuti.

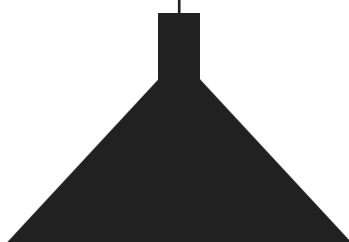

Cliente



Your projects,

Projects — Private house

Turin, Italy

Planned out by
Nicoletta Carbotti

Products:
Mapa Bianco, Swing.



light up by

Projects — Bolero Estudio

Las Palmas de Gran Canaria, Spain

Products:
Ego.







our products.

Projects — La cassa rurale

Salò, Italy

Planned out by
ArchLight

Products:
Oracle Slim.





Sospensioni

Interni

Indice alfabetico

Abc	99	Coco	181	Flut	143
A-Line	125	Colossal	216	Folk	151
Amadeus	219	Cono	138	Frame	76
Ampolla	116	Copernico	110	Frida	120
Archimede	127	Corte	215	Galaxy	104
Aria	152	Cotton	159	Gemini	60
Arizona	156	Craft	91	Gioconda	224
Audi-10	186	Crown	66	Glory	155
Audi-80	187	Cylinder	190	Gretel	185
Avion	177	Danieli	228	Harem	233
Bergen	183	Desk	90	Haunt	190
Birds	105	Diamond	102	Holly	128
Bistro'	184	Diesis	126	Hulahoop	74
Blanche	214	Dna	174	Ice	118
Blossom	146	Doge	227	Igor	101
Boa	171	Dream Big	176	Justine	231
Bon Bon	231	Driftwood	235	Karma	150
Breeze	133	Dubai	208	Karousel	92
Brigitta	229	Dynamite	96	Kepler	111
Caesar	209	Edison	120	King	200
Canapa	235	Empire	179	Konse	115
Candy	158	Equinoxe	108	Kuky	139
Cantina	137	Eris	135	Lana	153
Carlton	203	Essence	88	Leaves	112
Carta	170	Evasione	207	Lena	153
Casanova	226	Fade	147	Lingotto	100
Chalet	234	Filo	84	Look	78
Circus	75	Firenze	230	Lord	146
Citrus	119	Fisherman	136	Lucciola	94
Clown	160	Flam	80	Luce Max	161
Cocktail	141	Florian	220	Lugano	119



























































Indice alfabetico

Lumiere	178	Pop	95
Luxor	206	Rain	201
Madame	188	Rhapsody	93
Manhattan	142	Rose	217
Mapa	168	Set Up	192
Mapa Clear	166	Set Up Slim	194
Mapa Max	161	Set Up Ultra Slim	196
Mapa Mini	164	Sky	83
Mapa Plus	162	Smarties	154
Martinez	202	Soft	180
Metro	133	Strauss	225
Milk	140	Swan	199
Millennium	210	Tall	124
Minor	97	Topico	148
Mint	182	Triade	129
Miracle	67	Triumph	98
Mix Up	130	Tube	82
Moby	134	Ulisse	156
Monet	211	Ultrathin	86
Mr Jack	121	Umile	145
Nabucco	204	Vanity	232
Napoleon	222	V-Line	89
Negresco	218	Vortex	113
Nemo	172	Waves	58
Net	114	Yoko	89
Nodi	175	Yurta	132
Nordik	189		
Norma	232		
Oak	82		
Oil	122		
Onion	117		
Opera	198		
Oracle	74		
Oracle Slim	68		
Origami	144		
Ovalino	157		
Oz	64		
Pan	191		
Pasha'	205		
Pegaso	212		
Perlage	106		
Perline	105		
Plisse'	152		

























































Sospensioni

Indice icone

 new	 new	 new		 new	 new	
Waves 058	Gemini 060	Oz 064	Crown 066	Miracle 067	OracleSlim 068	Oracle 074
				 new		
Hulahoop 074	Circus 075	Frame 076	Look 078	Flam 080	Tube 082	Oak 082
	 new	 new	 new			 new
Sky 083	Filo 084	Ultrathin 086	Essence 088	Yoko 089	V-Line 089	Desk 090
						
Craft 091	Karousel 092	Rhapsody 093	Lucciola 094	Pop 095	Dynamite 096	Minor 097
				 new	 new	
Triumph 098	Abc 099	Lingotto 100	Igor 101	Diamond 102	Galaxy 104	Birds 105
		 new				
Perline 105	Perlage 106	Equinoxe 108	Copernico 110	Kepler 111	Leaves 112	Vortex 113
						
Net 114	Konse 115	Ampolla 116	Onion 117	Ice 118	Citrus 119	Lugano 119
						
Frida 120	Edison 120	Mr Jack 121	Oil 122	Tall 124	A-Line 125	Diesis 126

Sospensioni

Indice icone

						
Archimede 127	Holly 128	Triade 129	Mix Up 130	Yurta 132	Metro 133	Breeze 133
	new 					
Cantina 137	Cono 138	Kuky 139	Milk 140	Cocktail 141	Manhattan 142	Flut 143
		new 				
Lord 146	Fade 147	Topico 148	Karma 150	Folk 151	Aria 152	Plissé 152
						
Glory 155	Ulisse 156	Arizona 156	Ovalino 157	Candy 158	Cotton 159	Clown 160
new 		new 			new 	
Mapa Mini 164	Mapa 168	Mapa Clear 169	Carta 170	Boa 171	Nemo 172	Dna 174
						
Lumiere 178	Empire 179	Soft 180	Coco 181	Mint 182	Bergen 183	Bistrò 184
					new 	new 
Madame 188	Nordik 189	Cylinder 190	Haunt 190	Pan 191	Set Up 192	SetUp Slim 194
						
King 200	Rain 201	Martinez 202	Carlton 203	Nabucco 204	Pashà 205	Luxor 206



Moby 134



Eris 135



Fisherman 136



Origami 144



Umile 145

new



Blossom 146



Lana 153



Lena 153



Smarties 154



Mapa Max 161



Mapa Plus 162



Luce Max 161



Nodi 175



Dream Big 176



Avion 177



Gretel 185



Audi-10 186



Audi-80 187

new



SetUp Ultra Slim 196



Opera 198



Swan 199



Evasione 207



Dubai 208



Caesar 209



Set Up

Pag 190



Opera

Pag 198



Millennium 210



Monet 211



Florian 220



Napoleon 222



Justine 231



Bon Bon 231

Sospensioni

Indice icone



Pegaso 212



Blanche 214



Corte 215



Colossal 216



Rose 217



Negresco 218



Amadeus 219



Gioconda 224



Strauss 225



Casanova 226



Doge 227



Danieli 228



Brigitta 229



Firenze 230



Vanity 232



Norma 232



Harem 233



Chalet 234



Canapa 235



Driftwood 235



Waves **new**

Rosone, montatura e supporti a soffitto in metallo verniciato opaco. Cavi di sostegno in acciaio. Cavo elettrico in pvc. Diffusore in gomma opale. Colori: bianco, nero o oro.

LED Sorgente luminosa LED 3000 K, 30.000 h di durata.



345239



345215



345222

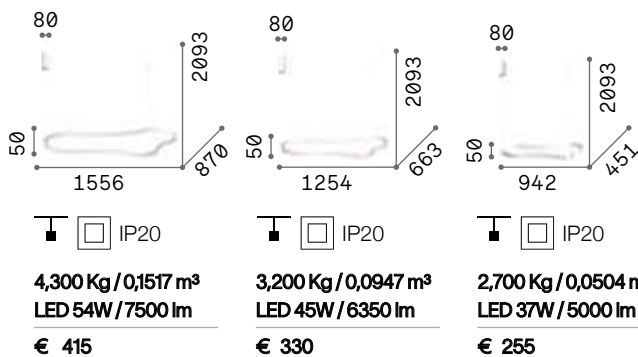

- | | | | | | | | | |
|--------|--------|-----|--------|--------|-----|--------|--------|-----|
| 345291 | Bianco | new | 345260 | Bianco | new | 345239 | Bianco | new |
| 345277 | Nero | new | 345246 | Nero | new | 345215 | Nero | new |
| 345284 | Oro | new | 345253 | Oro | new | 345222 | Oro | new |

Gemini new

Rosone e paralume in metallo verniciato a polveri o placcato. Diffusore in policarbonato opale. Cavo in pvc trasparente. Disponibile nelle finiture bianco, nero o ottone spazzolato. Modelli con diametro 810 mm e 610 mm disponibili anche in versione dimmerabile DALI/Push.

Sorgente	LED SMD	Durata LED	50.000 h
Potenza	36W / 78W	Classe	I
Driver incluso	On/Off / DALI/Push	isolamento	
Driver disponibili	No	IP	20
Angolo	130°	Materiale	Alluminio
CCT	2700 K / 3000 K		
CRI	≥90		

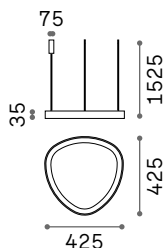

1,450 Kg / 0,0201 m³

LED SMD Driver incluso - Lunghezza cavo 2000 mm

Dimensioni	Potenza	Driver	Lumen	CCT	Finitura	Codice	€
425x425	36 W	On-Off	4000 lm	2700 K	Bianco	341521	240 <small>new</small>
					Nero	341538	240 <small>new</small>
					Ottone	341545	240 <small>new</small>
			4150 lm	3000 K	Bianco	247229	240
					Nero	247236	240
					Ottone	247243	240

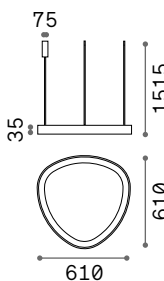

On/Off 1,710 Kg / 0,0462 m³

DALI/Push 1,600 Kg / 0,0389 m³

LED SMD Driver incluso - Lunghezza cavo 2000 mm

Dimensioni	Potenza	Driver	Lumen	CCT	Finitura	Codice	€
610x610	47 W	On-Off	4950 lm	2700 K	Bianco	341552	330 <small>new</small>
					Nero	341569	330 <small>new</small>
					Ottone	341576	330 <small>new</small>
			5100 lm	3000 K	Bianco	247250	330
					Nero	247267	330
					Ottone	269832	330
		DALI/Push	5100 lm	3000 K	Bianco	304717	425
		Nero			304694	425	
		Ottone			304700	425	





247229



247236



247243

Gemini

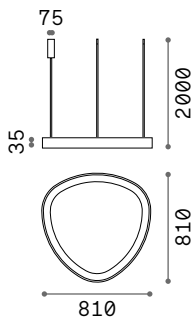

On/Off 2,300 Kg / 0,0703 m³
 DALI/Push 2,300 Kg/0,0703 m³

LED SMD Driver incluso - Lunghezza cavo 2000 mm

Dimensioni	Potenza	Driver	Lumen	CCT	Finitura	Codice	€
810x810	56 W	On-Off	6200 lm	2700 K	Bianco	341583	430 <i>new</i>
					Nero	341590	430 <i>new</i>
					Ottone	341606	430 <i>new</i>
	55 W	DALI/Push	6300 lm	3000 K	Bianco	247274	430
					Nero	247281	430
					Ottone	269849	430
					Bianco	304748	525
					Nero	304724	525
					Ottone	304731	525

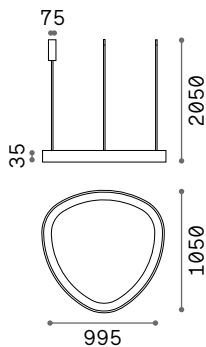

4,000 Kg / 0,1145 m³

LED SMD Driver incluso - Lunghezza cavo 2300 mm

Dimensioni	Potenza	Driver	Lumen	CCT	Finitura	Codice	€
1050x995	82 W	On-Off	8500 lm	2700 K	Bianco	341613	650 <i>new</i>
					Nero	341620	650 <i>new</i>
					Ottone	341637	650 <i>new</i>
			8700 lm	3000 K	Bianco	303895	650
					Nero	307695	650
					Ottone	307701	650





Base e montatura in metallo verniciato a polveri o placcato. Cavi in pvc. Diffusore in gomma opale. Finiture: bianco, nero o ottone spazzolato. Disponibile anche in versione dimmerabile DALI/Push.



Sorgente luminosa LED 2700 K / 3000 K / 4000 K, 30.000 h di durata.

Sorgente	LED SMD	Durata LED	30.000 h
Potenza	47W / 55W	Classe	II
Driver incluso	On/Off / DALI/Push	isolamento	
Driver disponibili	No	IP	20
CCT	2700 K / 3000 K / 4000 K	Materiale	Alluminio
CRI	≥90		

LED SMD Driver incluso - Lunghezza cavo 2000 mm

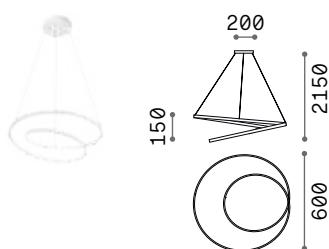

1,500 Kg / 0,0354 m³

Dimensioni	Potenza	Driver	Lumen	CCT	Finitura	Codice	€
ø 600	47 W	On-Off	5000 lm	2700 K	Bianco	342344	250 <small>new</small>
					Nero	342351	250 <small>new</small>
					Ottone	342368	250 <small>new</small>
			5100 lm	3000 K	Bianco	253671	250
					Nero	269436	250
					Ottone	269443	250
	48 W	DALI/Push	5100 lm	3000 K	Bianco	304540	390
					Nero	304557	390
					Ottone	304564	390
			5500 lm	4000 K	Bianco	342375	250 <small>new</small>
					Nero	342382	250 <small>new</small>
					Ottone	342399	250 <small>new</small>

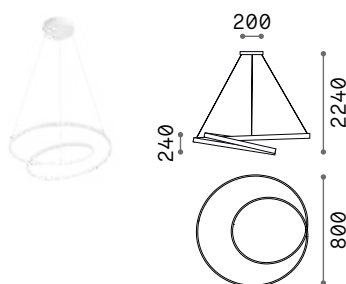

1,900 Kg / 0,0607 m³

LED SMD Driver incluso - Lunghezza cavo 2000 mm

Dimensioni	Potenza	Driver	Lumen	CCT	Finitura	Codice	€
ø 800	52 W	On-Off	5800 lm	2700 K	Bianco	342405	295 <small>new</small>
					Nero	342412	295 <small>new</small>
					Ottone	342429	295 <small>new</small>
			6100 lm	3000 K	Bianco	253664	295
					Nero	269450	295
					Ottone	269467	295
	55 W	DALI/Push	6100 lm	3000 K	Bianco	304571	470
					Nero	304588	470
					Ottone	304595	470
			6400 lm	4000 K	Bianco	342436	295 <small>new</small>
					Nero	342443	295 <small>new</small>
					Ottone	342450	295 <small>new</small>







Crown

Rosone e montatura in metallo con finitura ottone spazzolato. Cavo in pvc nero. Diffusore in acrilico opale con elemento decorativo in acrilico trasparente con effetto cristallo molato.



LED Sorgente luminosa LED 3000 K, 30.000 h di durata.

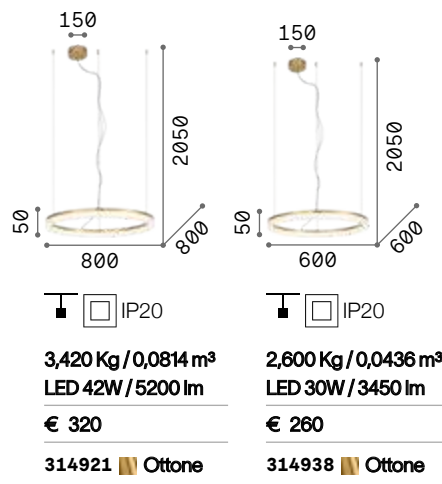



Miracle ^{new}

Rosone, montatura e supporti a soffitto in metallo verniciato a polveri opaco. Cavi di sostegno in acciaio. Cavo elettrico in pvc. Diffusore con elementi acrilici trasparenti decorati in rilievo con effetto cristallo. Colore: bianco.

LED Sorgente luminosa LED 3000 K, 30.000 h di durata.

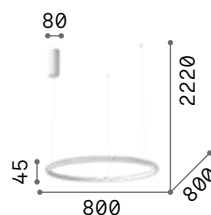

IP20

1,800 Kg / 0,0723 m³
LED 45W / 6200 lm

€ 215

325835 Bianco ^{new}

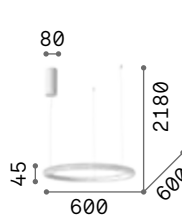

IP20

1,550 Kg / 0,0417 m³
LED 37W / 4900 lm

€ 170

325828 Bianco ^{new}

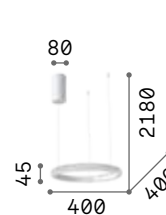

IP20

1,200 Kg / 0,0194 m³
LED 25W / 3300 lm

€ 130

325804 Bianco ^{new}

Oracle Slim Round new

Lampada a sospensione costituita da una montatura sottile in alluminio verniciato bianco o nero opaco e diffusore opale in policarbonato. Disponibile in quattro dimensioni diverse. LED integrati, disponibile in temperatura di colore 2700 K, 3000 K e 4000 K e con controllo ON-OFF oppure dimmerabile DALI/Push, CRI ≥ 90, durata utile LED 50.000 h, protezione IP20, classe isolamento II.

Sorgente	LED SMD	CRI	≥90
Potenza	29W / 83W	Durata LED	50.000 h
Driver incluso	On/Off / DALI/Push	Classe	II
Driver disponibili	No	isolamento	
Angolo	115°	IP	20
CCT	2700 K / 3000 K / 4000 K	Materiale	Alluminio

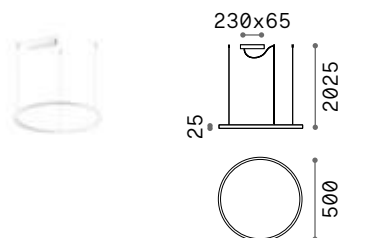

On/Off 1,400 Kg/0,0376 m³
DALI/Push 1,170 Kg/0,0272 m³

LED SMD Driver incluso - Lunghezza cavo 2500 mm

Dimensioni	Potenza	Driver	Lumen	CCT	Finitura	Codice	€
ø 500	29 W	On-Off	2850 lm	2700 K	Bianco	342016	180 new
					Nero	342009	180 new
			3000 lm	3000 K	Bianco	229461	180
					Nero	229492	180
			3400 lm	4000 K	Bianco	269856	180
					Nero	304380	180
	29 W	DALI/Push	2850 lm	3000 K	Bianco	304373	255
					Nero	304366	255
			3100 lm	4000 K	Bianco	342030	255 new
					Nero	342023	255 new

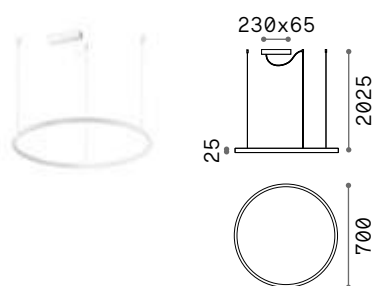

On/Off 1,660 Kg/0,0809 m³
DALI/Push 1,200 Kg/0,0534 m³

LED SMD Driver incluso - Lunghezza cavo 2500 mm

Dimensioni	Potenza	Driver	Lumen	CCT	Finitura	Codice	€
ø 700	37 W	On-Off	3800 lm	2700 K	Bianco	342054	245 new
					Nero	342047	245 new
			4250 lm	3000 K	Bianco	229485	245
					Nero	229515	245
			4350 lm	4000 K	Bianco	269863	245
					Nero	304410	245
	40 W	DALI/Push	4200 lm	3000 K	Bianco	304403	305
					Nero	304397	305
			4450 lm	4000 K	Bianco	342078	305 new
					Nero	342061	305 new





Oracle Slim Round

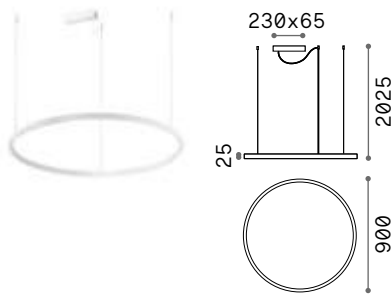

On/Off 1,800 Kg/0,2212 m³
 DALI/Push 1,500 Kg/0,0857 m³

LED SMD Driver incluso - Lunghezza cavo 2500 mm

Dimensioni	Potenza	Driver	Lumen	CCT	Finitura	Codice	€
ø 900	53 W	On-Off	5150 lm	2700 K	Bianco	342115	260 new
					Nero	342108	260 new
			5200 lm	3000 K	Bianco	229478	260
					Nero	229508	260
			5350 lm	4000 K	Bianco	269870	260
					Nero	304441	260
	43 W	DALI/Push	4500 lm	3000 K	Bianco	304434	375
					Nero	304427	375
			4600 lm	4000 K	Bianco	342139	375 new
					Nero	342122	375 new

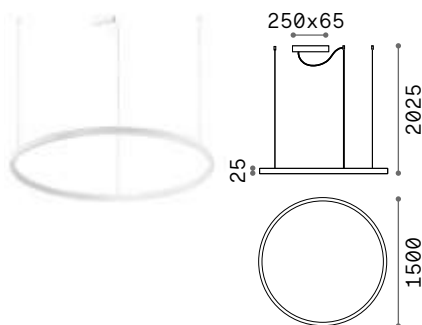

On/Off 2,480 Kg/0,3072 m³
 DALI/Push 2,000 Kg/0,3072 m³

LED SMD Driver incluso - Lunghezza cavo 2500 mm

Dimensioni	Potenza	Driver	Lumen	CCT	Finitura	Codice	€
ø 1500	83 W	On-Off	7850 lm	2700 K	Bianco	342177	490 new
					Nero	342160	490 new
			8750 lm	3000 K	Bianco	265957	490
					Nero	285061	490
			9350 lm	4000 K	Bianco	285078	490
					Nero	304472	490
	77 W	DALI/Push	7300 lm	3000 K	Bianco	304465	625
					Nero	304458	625
			7450 lm	4000 K	Bianco	342191	625 new
					Nero	342184	625 new





Oracle Slim Square

Lampada a sospensione costituita da una montatura sottile in alluminio verniciato bianco o nero opaco e diffusore opale in policarbonato. Disponibile in tre dimensioni diverse. LED integrati, disponibile in temperatura di colore 3000 K e con controllo ON-OFF, CRI ≥ 90, durata utile LED 50.000 h, protezione IP20, classe isolamento II.

Sorgente	LED SMD	Durata LED	50.000 h
Potenza	33W / 53W	Classe	II
Driver incluso	On/Off	isolamento	
Driver disponibili	No	IP	20
Angolo	115°	Materiale	Alluminio
CCT	3000 K		
CRI	≥90		

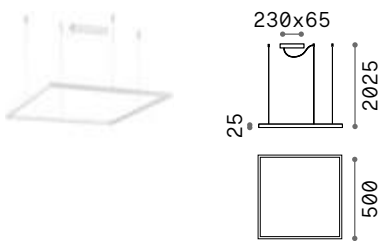

1,730 Kg/0,0422 m³

LED SMD Driver incluso - Lunghezza cavo 2500 mm

Dimensioni	Potenza	Driver	Lumen	CCT	Finitura	Codice	€
500x500	33 W	On-Off	3050 lm	3000 K	Bianco	259154	205
					Nero	259161	205

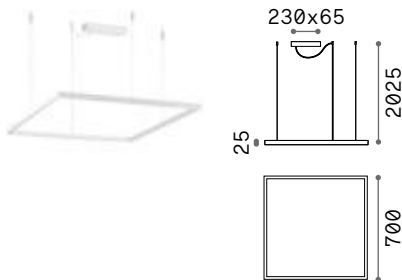

2,000 Kg/0,0819 m³

LED SMD Driver incluso - Lunghezza cavo 2500 mm

Dimensioni	Potenza	Driver	Lumen	CCT	Finitura	Codice	€
700x700	44 W	On-Off	4350 lm	3000 K	Bianco	259178	245
					Nero	259185	245

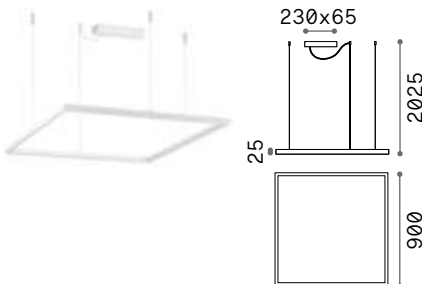

2,100 Kg/0,1317 m³

LED SMD Driver incluso - Lunghezza cavo 2500 mm

Dimensioni	Potenza	Driver	Lumen	CCT	Finitura	Codice	€
900x900	53 W	On-Off	5200 lm	3000 K	Bianco	259192	260
					Nero	259208	260



Oracle

Rosone e corpo luce in alluminio verniciato a polveri di colore bianco o nero. Diffusore in materiale plastico color opale. Sorgente luminosa a led integrati.

LED Sorgente luminosa LED 3000 K, 30.000 h di durata.

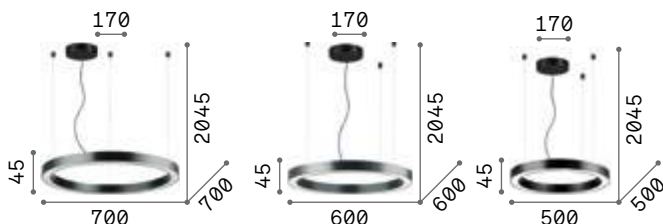

IP20

2,160 Kg / 0,0353 m³
LED 35W / 4100 lm

€ 480

211381 Bianco
222110 Nero

IP20

1,870 Kg / 0,0260 m³
LED 33W / 3800 lm

€ 415

211398 Bianco
222103 Nero

IP20

1,640 Kg / 0,0169 m³
LED 28W / 3200 lm

€ 350

211404 Bianco
222097 Nero



Hulahoop

Rosone e montatura in metallo verniciato a polveri con finitura bianca. Diffusore in gomma opale. Cavi in acciaio con supporti a soffitto. Cavo elettrico in pvc trasparente.

LED Sorgente luminosa LED 3000 K, 17.500 h di durata.

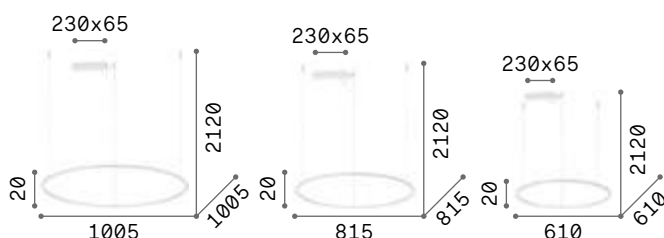

IP20

2,700 Kg / 0,1603 m³
LED 46W / 5950 lm

€ 310

258751 Bianco

IP20

1,800 Kg / 0,1060 m³
LED 39W / 4450 lm

€ 280

258768 Bianco

IP20

1,400 Kg / 0,0628 m³
LED 28W / 3000 lm

€ 190

258775 Bianco





Circus

Rosone e montatura in metallo verniciato a polveri con finitura nera Diffusore esterno in policarbonato opale. Cavo elettrico in PVC.

LED Sorgente luminosa LED 3000 K, 20.000 h di durata.

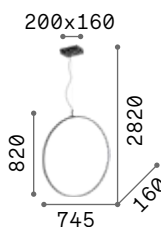

IP20

1,130 Kg / 0,0593 m³
LED 36W / 4250 lm

€ 290

291406 ■ Nero

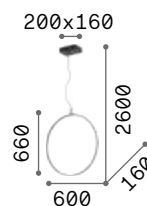

IP20

1,060 Kg / 0,0384 m³
LED 33W / 3550 lm

€ 255

291376 ■ Nero

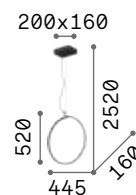

IP20

0,970 Kg / 0,0221 m³
LED 29W / 3200 lm

€ 220

291345 ■ Nero



Frame

Base e montatura in metallo verniciato bianco opaco o nero opaco. Diffusori in materiale plastico colore opale. Cavi regolabili in lunghezza. Emissione luce diretta.

LED Sorgente luminosa LED 3000 K, 30.000 h di durata.

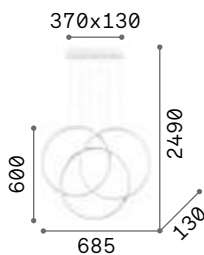
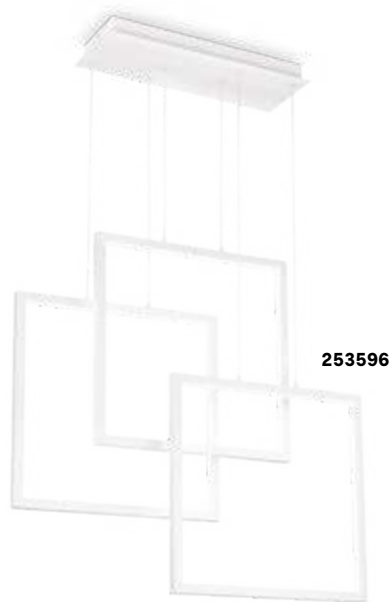
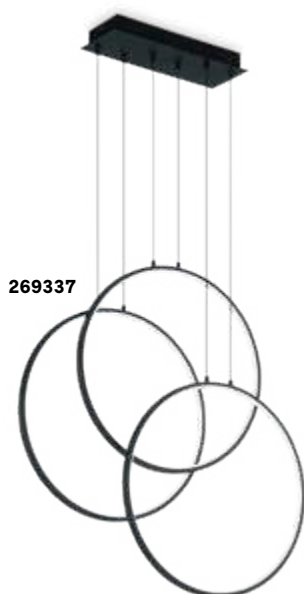

IP20

3,500 Kg / 0,1050 m³
LED 82W / 6850 lm

€ 400

269351 ■ Bianco
269337 ■ Nero

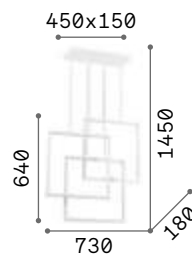

IP20

4,270 Kg / 0,0689 m³
LED 80W / 8550 lm

€ 580

253596 ■ Bianco
269375 ■ Nero

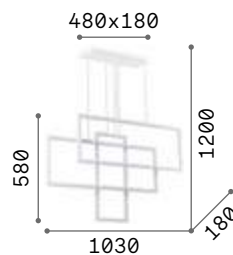

IP20

4,300 Kg / 0,2100 m³
LED 93W / 10050 lm

€ 600

253589 ■ Bianco
269382 ■ Nero



P. 247



P. 501



Look

Rosone e diffusore in metallo con varie finiture. Cavo in tessuto regolabile in lunghezza. Monta lampadine sostituibili. Modello con finitura cromo sfumato con diffusore in vetro.

LED Lampadine LED GU10 7W, GU10 10W e GU10 4W 3000 K incluse.



104935 104942 104928 141800 313894 141817 259239 141794 141855 170589

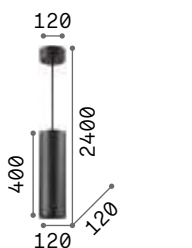

2,950 Kg / 0,0092 m³
GU10 max 1x28W

€ 140

158723 ■ Nero

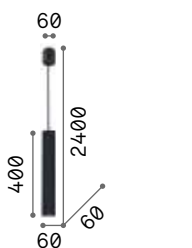

0,990 Kg / 0,0029 m³
GU10 max 1x28W

€ 60

104935 ■ Bianco
104928 ■ Nero
259239 ■ Ottone

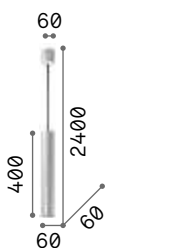

0,990 Kg / 0,0029 m³
GU10 max 1x28W

€ 80

194806 ■ Trasparen.
141800 ■ Argento
141817 ■ Oro
104942 ■ Cromo
141794 ■ Brunito
141855 ■ Rame
170589 ■ Coffee

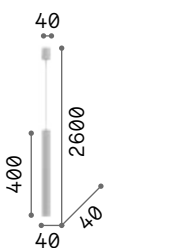

0,650 Kg / 0,0019 m³
GU10 max 1x28W

€ 65

346854 ■ Bianco
346861 ■ Cromo
343310 ■ Nero

new
new
new



P. 300 P. 381 P. 506 P. 698



189031 € 15,00



123943 € 3,50

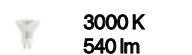

123943 € 3,50



339771 € 3,00



Flam new

Rosone e montatura in metallo verniciato a polveri. Diffusore in vetro borosilicato. Cavo in pvc nero. Colore montatura: nero. Colori diffusore: trasparente, trasparente sfumato fumè o fumè.

LED Sorgente luminosa LED 3000 K, 30.000 h di durata.

321042

321059

345512

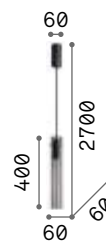

IP20

0,820 Kg / 0,0054 m³
LED 10W / 900 lm

€ 115

321059 **Trasparen.** new
321042 **Fumè** new
345512 **Sfumato** new

Tube

Rosone e corpo luce in alluminio verniciato a polveri di colore bianco o nero. Cavo in tessuto. Sorgente luminosa a led integrati.

LED Sorgente luminosa LED 3000 K, 35.000 h di durata.

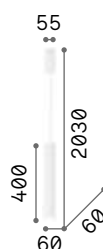

IP20

0,960 Kg / 0,0073 m³
LED 11W / 1050 lm

€ 210

211701 ■ Bianco
211718 ■ Nero

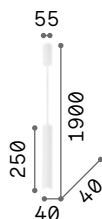

IP20

0,680 Kg / 0,0048 m³
LED 11W / 1050 lm

€ 150

211459 ■ Bianco
211466 ■ Nero

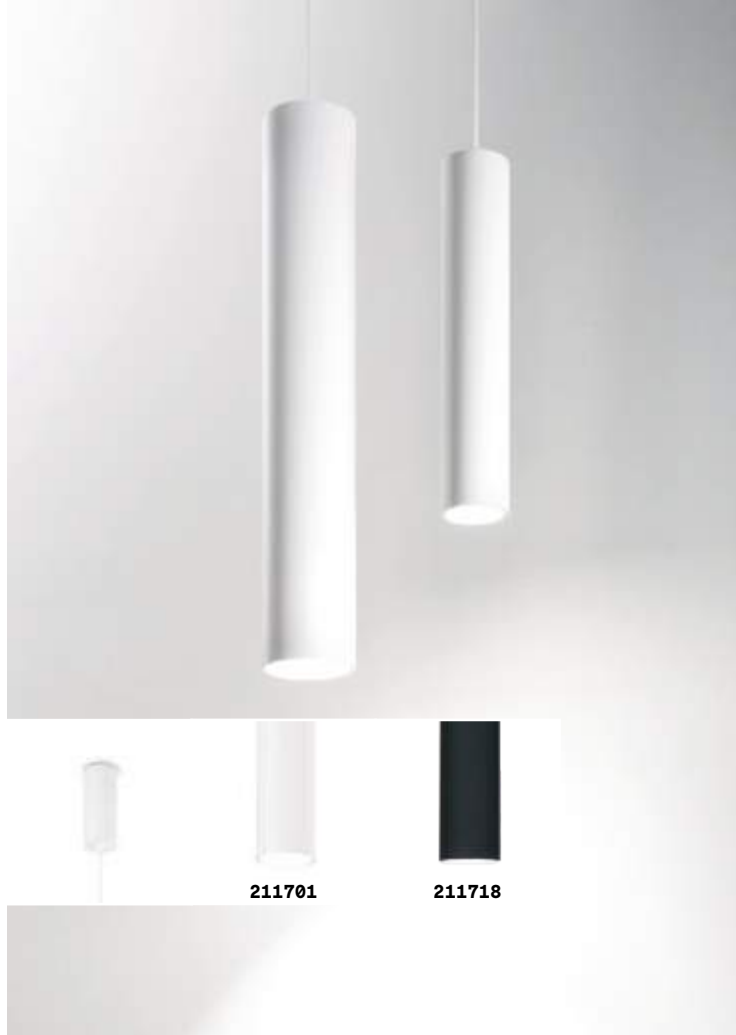

211701

211718

Oak

Rosone in metallo rifinito con vernice opaca. Diffusore in cemento. Cavo in tessuto nero.

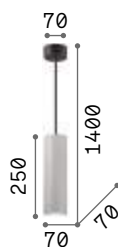

IP20

1,220 Kg / 0,0055 m³
GU10 max 1x35W

€ 85

150635 ■ Cemento

3000 K
410 lm

108292 € 3,00



P. 310





Sky

Rosone e diffusore in metallo placcato o rifinito con vernice opaca bianco o nero.

LED Lampadine LED GU10 7W 3000 K incluse. Cod. **123943**



126906

126913

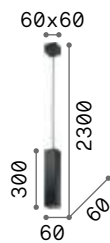

0,950 Kg / 0,0043 m³
GU10 max 1x 28W

€ **96**

126906 ■ Bianco
126913 ■ Nero

 **3000 K**
540 lm

123943 € **3,50**

 **P. 301**  **P. 381**



300801

Filo new

Rosone e corpi luci in metallo verniciato a polveri o placcato. Cavi elettrici in pvc nero. Modelli 300801, 300818 e 300825 con 4 metri di cavo e interruttore sul rosone. Colori: bianco, nero oppure ottone satinato.

LED Sorgente luminosa LED 2700 K / 3000 K, 20.000 h di durata.

ON Lampada con interruttore integrato.
OFF Cod. **300818, 300801, 300825.**

263687

263670

263700

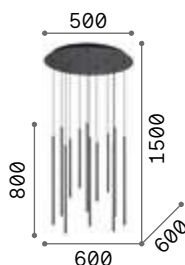

8,600 Kg / 0,0635 m³
LED 19W / 2050 lm / 2100 lm

€ 450

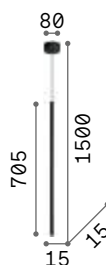

0,530 Kg / 0,0142 m³
LED 3,5W / 220 lm

€ 75

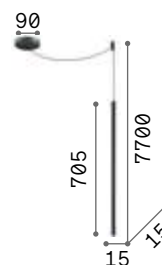

0,830 Kg / 0,0105 m³
LED 3,5W / 220 lm

€ 110

341088	■ Bianco	2700K ^{new}	341057	■ Bianco	2700K ^{new}	300818	■ Bianco
263441	■ Bianco	3000K	263687	■ Bianco	3000K	300801	■ Nero
341095	■ Nero	2700K ^{new}	341064	■ Nero	2700K ^{new}	300825	■ Ottone
263434	■ Nero	3000K	263670	■ Nero	3000K		
341101	■ Ottone	2700K ^{new}	341071	■ Ottone	2700K ^{new}		
263663	■ Ottone	3000K	263700	■ Ottone	3000K		



086

Ultrathin new

Rosone e corpo luce in metallo verniciato opaco o placcato. Cavo in tessuto. Colori: bianco, cromo, ottone spazzolato o nero.

LED Sorgente luminosa LED 3000 K, 30.000 h di durata.



339733, 339726



142913 321783
156699 321813



339757, 339740



194196, 194202

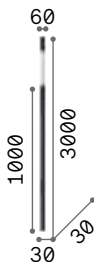

0,670 Kg / 0,0036 m³
LED 11,5W / 1150 lm / 51°

€ 143 On-Off / 205 Dali

142906	Bianco	On-Off
164878	Cromo	On-Off
142913	Nero	On-Off
339733	Ottone	On-Off new
321783	Nero	Dali/Push

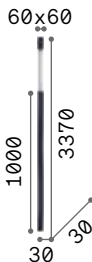

0,860 Kg / 0,0036 m³
LED 11,5W / 1150 lm / 51°

€ 209

194172	Bianco
194196	Nero
339757	Ottone new

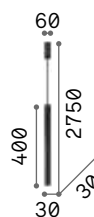

0,460 Kg / 0,0036 m³
LED 11,5W / 1150 lm / 51°

€ 108 On-Off / 176 Dali

156682	Bianco	On-Off
187662	Cromo	On-Off
156699	Nero	On-Off
339726	Ottone	On-Off new
321813	Nero	Dali/Push

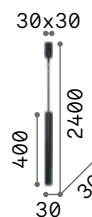

0,450 Kg / 0,0019 m³
LED 11,5W / 1150 lm / 51°

€ 170

194189	Bianco
194202	Nero
339740	Ottone new



Essence ^{new}

Rosone e corpo luce in alluminio verniciato a polveri. Diffusore in materiale acrilico opale. Cavi in pvc. Colori: bianco o nero.

LED Sorgente luminosa LED 2700 K / 3000 K, 30.000 h di durata.

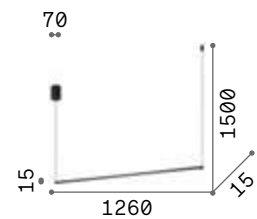
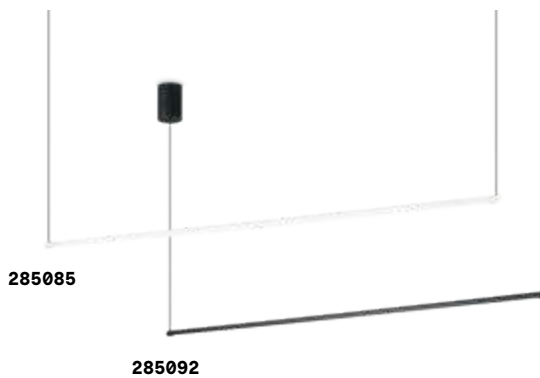

IP20

0,900 Kg / 0,0165 m³
LED 19W / 2150 / 2300 / 2350 lm

€ 275

341033	■ Nero	2700K ^{new}
285085	■ Bianco	3000K
285092	■ Nero	3000K
341040	■ Nero	4000K ^{new}



Yoko

Rosone, montatura e supporto per il cavo in metallo verniciato opaco. Diffusore in policarbonato opale. Cavo in pvc trasparente. Colori: bianco o nero.

LED Sorgente luminosa LED 3000 K, 30.000 h di durata.

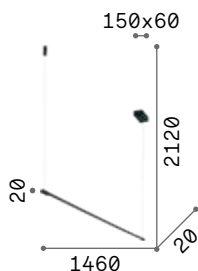

IP20

0,700 Kg / 0,0383 m³
LED 17W / 1700 lm

€ 130

258898 ■ Bianco
258928 ■ Nero



P. 457 P. 503



V-Line

Corpo luce in alluminio verniciato a polveri. Diffusore in silicone opale. Cavi d'acciaio con supporti cromati. Cavo elettrico in pvc. Colori: bianco o nero.

LED Sorgente luminosa LED 3000 K, 20.000 h di durata.

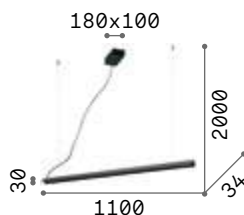

IP20

1,050 Kg / 0,0058 m³
LED 20W / 1700 lm

€ 215

275369 ■ Bianco
275376 ■ Nero





138237

336183 / 336206

336190 / 336176

Desk **new**

Rosone e corpo luce in alluminio verniciato a polveri. Cavo elettrico in pvc. Disponibile con sorgente singola a emissione diffusa, con sorgente doppia a emissione diffusa sopra e sotto o con sorgente doppia a emissione diffusa in alto e concentrata in basso.



173245 / 336190



336176

LED Sorgente luminosa LED 3000 K, 30.000 h di durata.

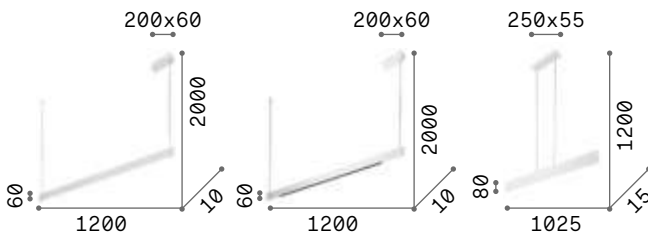

1,800 Kg / 0,0094 m³
LED 36W / 4000 lm

€ 180



1,800 Kg / 0,0094 m³
LED 36W / 4000 lm

€ 180



1,860 Kg / 0,0140 m³
LED 32W / 2100 lm

€ 180

336206 **Bianco** **new** 336183 **Bianco** **new** 138237 **Bianco**
336190 **Nero** **new** 336176 **Nero** **new** 173245 **Nero**



P. 374



Craft

Rosone in metallo verniciato nero opaco. Corpo luce in legno naturale. Diffusore in policarbonato opale satinato. Cavo in PVC trasparente.

LED Sorgente luminosa LED 3000 K, 20.000 h di durata.

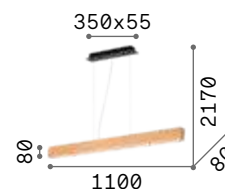

IP20

3,400 Kg / 0,0238 m³
LED 32W / 2700 lm

€ 360

284460 ■ Legno



P. 374



P. 510



Karousel

Montatura in metallo rifinito in ottone satinato. Diffusori in vetro incamiciato bianco, soffiato e acidato.

LED Lampadine LED G9 3W 3000 K incluse.
Cod. **209043**



IP20	IP20
4,340 Kg / 0,1739 m³ G9 max 10 x 15W	2,810 Kg / 0,1055 m³ G9 max 6 x 15W
€ 780	€ 600
206394 Ottone	206387 Ottone
3000 K 510 lm	3000 K 510 lm
305486 € 6,00	305486 € 6,00



Rhapsody

Montatura in metallo con rosone rifinito ottone satinato e bracci nero opaco. Cavi in pvc. Diffusori in vetro soffiato bianco acidato.

LED Lampadine LED G9 3W 3000 K incluse.
Cod. **209043**

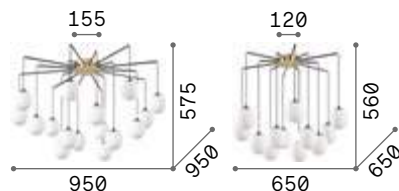

IP20 INCLUSA

5,020 Kg / 0,2040 m³
G9 max 16 x 15W

€ 750

236964 ■ Nero

3000 K
510 lm

305486 € 6,00

IP20 INCLUSA

3,510 Kg / 0,1400 m³
G9 max 12 x 15W

€ 550

236957 ■ Nero

3000 K
510 lm

305486 € 6,00



Lucciola

Rosone e corpo luce sospeso in metallo verniciato a polveri o placcato. Diffusore sferico in acrilico satinato. Cavi in pvc con supporti a soffitto in alluminio. Colore: ottone o nero.

LED

Sorgente luminosa LED 3000 K, 20.000 h di durata.



284002 284019

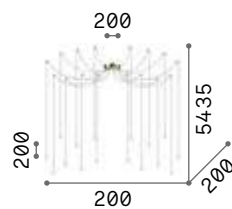

IP20

2,500 Kg / 0,0165 m³
LED 16W / 1300 lm

€ 550

284002 ■ Nero
284019 ■ Ottone



Pop

Rosone, montatura e copri portalampane in metallo rifinito con vernice opaca nera. Cavi regolabili in lunghezza.

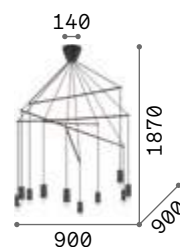

IP20

2,920 Kg / 0,0147 m³
E27 max 10 x 60W

€ 300

158860 ■ Nero

3000 K
900 lm

123899 € 3,50

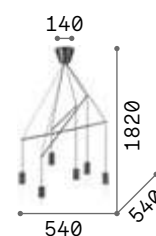

IP20

1,670 Kg / 0,0096 m³
E27 max 6 x 60W

€ 200

158815 ■ Nero

3000 K
900 lm

123899 € 3,50



Dynamite

Montatura in metallo rifinito con vernice a polveri o placcato e spazzolato. Diffusori orientabili. Cavo elettrico in tessuto. Sospensioni con incluso kit per installazione anche a plafone.

LED Lampadine LED GU10 7W 3000 K incluse. Cod. **123943**



231433

231396

244648



P. 312

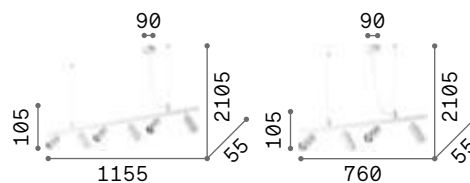

2,700 Kg / 0,0360 m³
GU10 max 6 x 28W

€ 350

231433 Bianco
231396 Nero
244648 Ottone

3000 K
540 lm

123943 € 3,50



2,310 Kg / 0,0243 m³
GU10 max 4 x 28W

€ 275

231372 Bianco
231341 Nero
244624 Ottone

3000 K
540 lm

123943 € 3,50



Minor

Montatura in metallo verniciato a polveri. Cavo elettrico in pvc. Sorgenti luminose a LED sostituibili.

LED Lampadine LED GX53 9W 3000 K incluse. Cod. **123936**

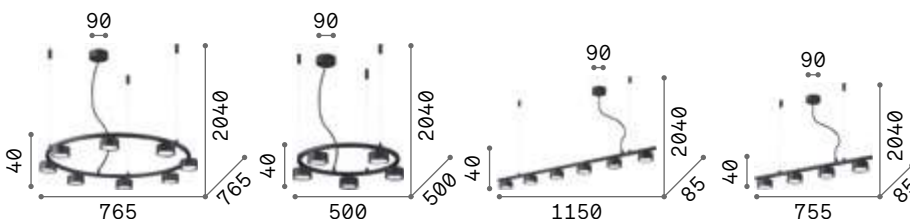

3,440 Kg / 0,1200 m³
GX53 max 8 x 9W

€ 480

235547 ■ Nero

3000 K
910 lm

123936 € 5,00



2,250 Kg / 0,0564 m³
GX53 max 5 x 9W

€ 325

235516 ■ Nero

3000 K
910 lm

123936 € 5,00



2,210 Kg / 0,0203 m³
GX53 max 6 x 9W

€ 325

235486 ■ Nero

3000 K
910 lm

123936 € 5,00



1,650 Kg / 0,0135 m³
GX53 max 4 x 9W

€ 247

235455 ■ Nero

3000 K
910 lm

123936 € 5,00





Triumph

Base, bracci e copri porta lampade in metallo placcato. Colore: ottone invecchiato.

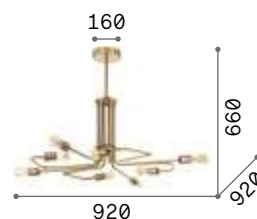

IP20

3,640 Kg / 0,0470 m³
E27 max 8 x 42W

€ 550

160269 Ottone

2200 K
370 lm

151687 € 2,50



P. 326 P. 424



Abc

Rosone, copri portalamapade e struttura decorativa interamente in metallo rifinito ottone satinato. Cavo in tessuto nero.

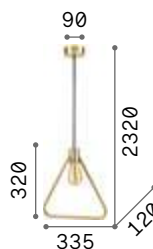

IP20

0,590 Kg / 0,0117 m³
E27 max 1x70W

€ 120

207834 Ottone

2200 K
440 lm
151694 € 4,00

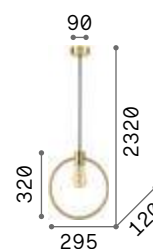

IP20

0,570 Kg / 0,0100 m³
E27 max 1x70W

€ 120

207841 Ottone

2200 K
330 lm
151700 € 4,00

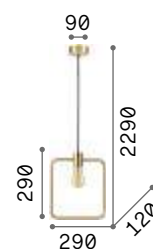

IP20

0,610 Kg / 0,0100 m³
E27 max 1x70W

€ 120

207858 Ottone

2200 K
500 lm
151717 € 6,00



Lingotto

Montatura in metallo verniciato: base nera opaca e telaio ottone opaco oppure completamente nero opaco. Diffusori in vetro incamiciato bianco, soffiato e acidato.



Lampadine LED G9 3W 3000 K incluse nei modelli: **327846**, **251110**, **327839** e **251103**. Cod. **209043**



P. 335



P. 477

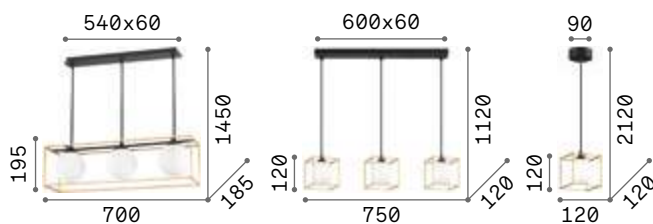

4,530 Kg / 0,0564 m³
E14 max 3 x 28W

€ 290

304144 ■ Nero
198125 ■ Ottone

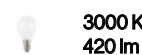

101217 € 2,00



2,260 Kg / 0,0442 m³
G9 max 3 x 4W

€ 240

327846 ■ Nero
251110 ■ Ottone

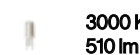

305486 € 6,00



0,660 Kg / 0,0105 m³
G9 max 1 x 4W

€ 90

327839 ■ Nero
251103 ■ Ottone

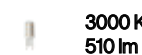

305486 € 6,00



Igor

Montatura in metallo rifinito con vernice opaca nera. Diffusore con lastre di vetro trasparente.

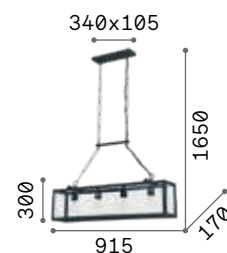

⏏ (E) IP20

8,810 Kg / 0,0941 m³
E27 max 4 x 42W

€ 390

092942 ■ Nero

💡 2200 K
440 lm

151694 € 4,00



Diamond **new**

Rosone in metallo cromato. Cavo in teflon trasparente. Diffusori in acrilico trasparente con lavorazione ad effetto cristallo molato.

LED Sorgente luminosa LED 3000 K, 20.000 h di durata.

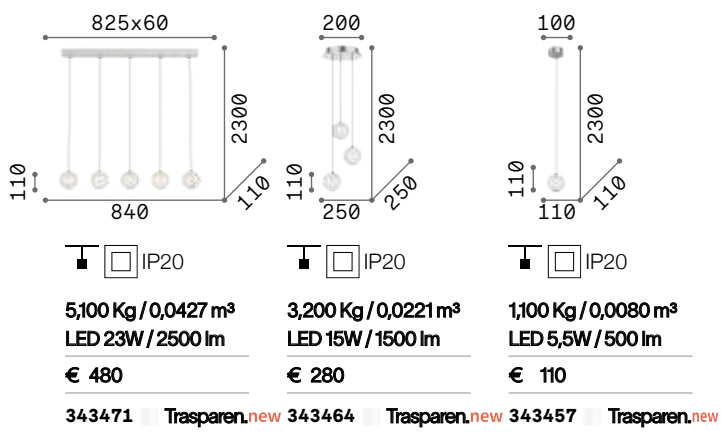



Galaxy **new**

Rosone in metallo rifinito nichel nero lucido. Cavi in pvc nero. Diffusori in acrilico opale e trasparente, con inserti centrali in metallo spazzolato color nichel, ottone e rame.

LED Sorgente luminosa LED 3000 K, 20.000 h di durata.

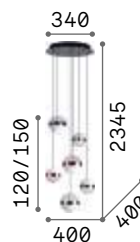

IP20

5,500 Kg / 0,0540 m³
LED 58W / 5400 lm

€ 650

321172 Bianco

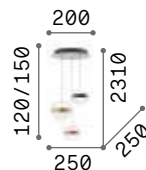

IP20

3,400 Kg / 0,0304 m³
LED 29W / 2800 lm

€ 476

342993 Bianco **new**

Birds

Montatura in metallo verniciato con disco decorativo in ottone satinato. Diffusori in vetro soffiato bianco acidato. Cavo in pvc. Colore: nero opaco con dettaglio ottone satinato.

LED Lampadine LED G9 3W 3000 K incluse.
Cod. **209043**

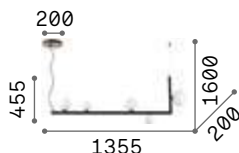

IP20

2,750 Kg / 0,1353 m³

G9 max 5 x 15W

€ 283

273648 ■ Nero

3000 K
510 lm

305486 € 6,00



P. 327 P. 421 P. 473 P. 497



Perline

Rosone e montatura in metallo. Diffusori in vetro incamiciato bianco, soffiato e acidato. Cavo elettrico in teflon trasparente. Finiture: nero opaco oppure ottone satinato.

LED Lampadine LED G9 3W 3000 K incluse.
Cod. **209043**

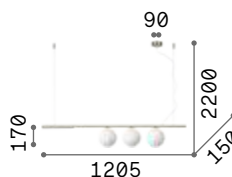

IP20

1,600 Kg / 0,0584 m³

G9 max 3 x 40W

€ 215

307008 ■ Nero

282114 ■ Ottone

3000 K
510 lm

305486 € 6,00

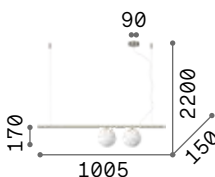

IP20

1,200 Kg / 0,0546 m³

G9 max 2 x 40W

€ 155

306995 ■ Nero

282107 ■ Ottone

3000 K
510 lm

305486 € 6,00



306995

282107



P. 324 P. 423 P. 473 P. 498

Perlage

Montatura in metallo con truttura lineare a sezione tonda o con struttura circolare a sezione quadrata. Diffusori in vetro soffiato. Cavo elettrico in pvc. Colori: montatura nero opaco con vetri fumè, montatura ottone satinato con vetri bianchi acidati o montatura ottone satinato con vetri ambra.

LED Lampadine LED G9 3W 3000 K incluse.
Cod. **209043**



283821



271422



317793

8,920 Kg / 0,2722 m ³ G9 max 30 x 15W	3,910 Kg / 0,0924 m ³ G9 max 14 x 15W	3,100 Kg / 0,0736 m ³ G9 max 11 x 15W	2,200 Kg / 0,0617 m ³ G9 max 10 x 15W	1,300 Kg / 0,0317 m ³ G9 max 6 x 15W
€ 1610	€ 713	€ 610	€ 448	€ 299
296746 Bianco 296753 Fumè 322780 Ambra	283814 Bianco 271385 Fumè 322797 Ambra	283807 Bianco 271392 Fumè 322773 Ambra	283791 Bianco 271408 Fumè 322766 Ambra	283821 Bianco 271422 Fumè 317793 Ambra
3000 K 510 lm	3000 K 510 lm	3000 K 510 lm	3000 K 510 lm	3000 K 510 lm
305486 € 6,00	305486 € 6,00	305486 € 6,00	305486 € 6,00	305486 € 6,00



Equinoxe new

Montatura in metallo placcato.
 Diffusori in vetro borosilicato
 trasparente. Cavo in pvc nero.
 Colori: montatura cromo con
 vetro trasparente o fumè sfumato,
 montatura ottone antico con vetro
 trasparente o ambra sfumato.

LED Lampadine LED G4 2W 3000 K incluse.
 Cod. 222257



200118



200125



345390



345383

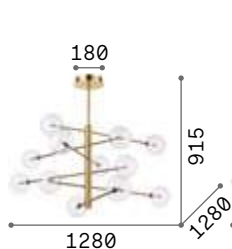

5,540 Kg / 0,1304 m³
 G4 max 12 x 2W
 € 1045

200118 Cromo
 200125 Ottone

3000 K
 200 lm
 222257 € 4,00

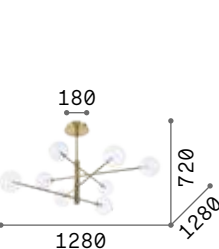

4,460 Kg / 0,1427 m³
 G4 max 8 x 2W
 € 825

275178 Cromo
 275215 Ottone

3000 K
 200 lm
 222257 € 4,00

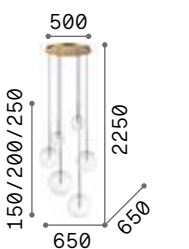

5,200 Kg / 0,1274 m³
 G4 max 6 x 2W
 € 715

317250 Cromo
 317243 Ottone

3000 K
 200 lm
 222257 € 4,00

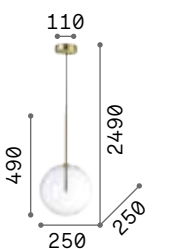

0,850 Kg / 0,0326 m³
 G4 max 1 x 2W
 € 198

306551 Cromo
 277394 Ottone

3000 K
 200 lm
 222257 € 4,00

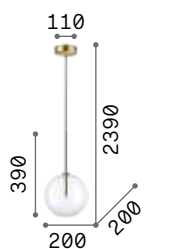

0,700 Kg / 0,0211 m³
 G4 max 1 x 2W
 € 154

306544 Cromo
 277387 Ottone

3000 K
 200 lm
 222257 € 4,00

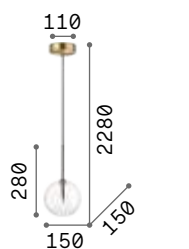

0,640 Kg / 0,0170 m³
 G4 max 1 x 2W
 € 132

306537 Cromo
 277370 Ottone

3000 K
 200 lm
 222257 € 4,00

345390 Fumè sfum.new 345437 Fumè sfum.new 345413 Fumè sfum.new 345376 Fumè sfum.new 345369 Fumè sfum.new 326351 Fumè sfum.new
 345383 Ambra Sf.new 345420 Ambra Sf.new 345406 Ambra Sf.new 326368 Ambra Sf.new 345352 Ambra Sf.new 345345 Ambra Sf.new



Copernico

Rosone e montatura in metallo verniciato opaco con dettagli in ottone. Cavo elettrico in pvc. Diffusori in vetro incamiciato bianco soffiato e acidato. Colore: nero.



197319

LED

Lampadine LED G9 3W 3000 K incluse.
Cod. 209043

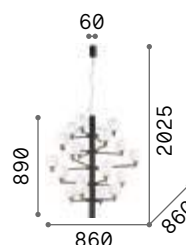

IP20

10,270 Kg / 0,1340 m³
G9 max 20 x 4W

€ 1050

197333 ■ Nero

3000 K
510 lm

305486 € 6,00

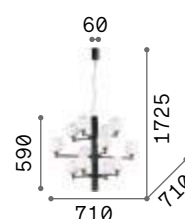

IP20

6,870 Kg / 0,0970 m³
G9 max 12 x 4W

€ 650

197319 ■ Nero

3000 K
510 lm

305486 € 6,00



Kepler

Catena e montatura in metallo verniciato nero opaco. Diffusori in vetro soffiato trasparente ambrato.

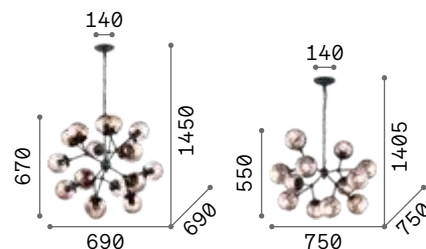

IP20

5,300 Kg / 0,1789 m³
E27 max 18 x 42W

€ 400

162478 ■ Nero

3000 K
430 lm

101279 € 2,00

IP20

3,630 Kg / 0,0990 m³
E27 max 12 x 42W

€ 300

162201 ■ Nero

3000 K
430 lm

101279 € 2,00





Leaves

Montatura in metallo bianco.
Elementi decorativi in vetro soffiato bianco e modellato a mano. Cavi d'acciaio regolabili in lunghezza.



Lampadine LED G9 3W 3000 K incluse.
Cod. **209043**

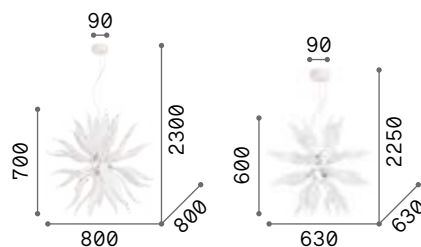

5,800 Kg / 0,1123 m³
G9 max 12 x 40W

€ 880

112268 **Blanco**

3000 K
510 lm

305486 **€ 6,00**



3,700 Kg / 0,0702 m³
G9 max 8 x 40W

€ 580

111957 **Blanco**

3000 K
510 lm

305486 **€ 6,00**



Vortex

Montatura in metallo verniciato bianco opaco. Elementi decorativi in metallo modellato artigianalmente e dipinti a mano con oro o argento.



101613



101606

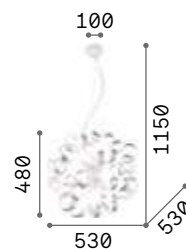

IP20

2,500 Kg / 0,2344 m³
E14 max 6 x 40W

€ 250

101613 Argento
101606 Oro

3000K
480lm

101200 € 2,00



Net

Rosone in metallo verniciato opaco.
Cavo in pvc. Diffusore in rete
metallica verniciata opaca. Finiture:
bianco, nero, oro.

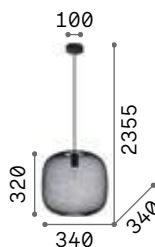

IP20

0,950 Kg / 0,0518 m³
E27 max 1x 42W

€ 70

328133 Bianco
328126 Nero
317281 Oro

3000 K
900 lm

123899 € 3,50



IP20

0,750 Kg / 0,0342 m³
E27 max 1x 42W

€ 60

328102 Bianco
313788 Nero
313771 Oro

3000 K
900 lm

123899 € 3,50

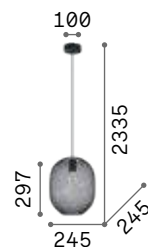

IP20

0,750 Kg / 0,0281 m³
E27 max 1x 42W

€ 60

317274 Bianco
328119 Nero
317267 Oro

3000 K
900 lm

123899 € 3,50



328102



313788



313771



Konse

Montatura ed elementi decorativi interamente in metallo. Finitura con vernice oro scuro satinato.

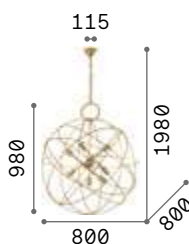

IP20

4,600 Kg / 0,7203 m³
E27 max 7 x 60W

€ 650

156033 Oro

3000 K
910 lm
119571 € 3,50

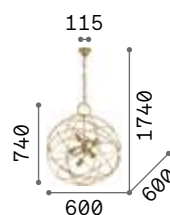

IP20

3,510 Kg / 0,1201 m³
E27 max 6 x 60W

€ 450

156026 Oro

3000 K
910 lm
119571 € 3,50

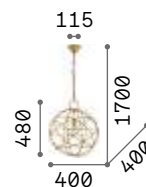

IP20

1,930 Kg / 0,1175 m³
E27 max 1 x 60W

€ 225

155968 Oro

3000 K
910 lm
119571 € 3,50



Ampolla

Rosone, porta lampade e struttura decorativa in metallo verniciato opaco. Cavo in pvc. Colore: nero.



167497

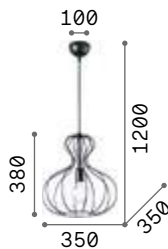

IP20

0,950 Kg / 0,0709 m³
E27 max 1x60W

€ 120

148502 ■ Nero

2200 K
500 lm

151717 € 6,00

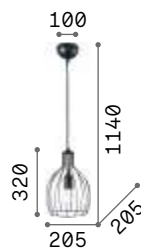

IP20

0,590 Kg / 0,0480 m³
E27 max 1x60W

€ 110

148151 ■ Nero

2200 K
370 lm

151687 € 2,50

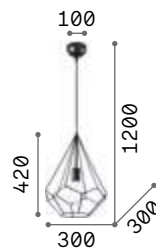

IP20

0,720 Kg / 0,0480 m³
E27 max 1x60W

€ 198

148175 ■ Nero

2200 K
440 lm

151694 € 4,00



IP20

1,470 Kg / 0,0709 m³
E27 max 1x60W

€ 214

167497 ■ Nero

2200 K
440 lm

151694 € 4,00



Onion

Struttura in metallo con finitura in vernice marrone ad effetto metallico. Cavo in tessuto.

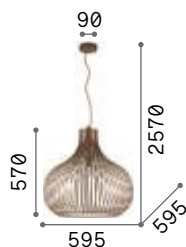

IP20

5,050 Kg / 0,2383 m³
E27 max 1x60W

€ 400

205311 ■ Coffee

2200 K
480 lm

151724 € 6,00



IP20

3,520 Kg / 0,1325 m³
E27 max 1x60W

€ 270

205304 ■ Coffee

2200 K
480 lm

151724 € 6,00

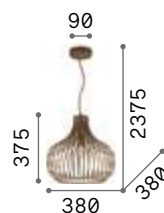

IP20

2,380 Kg / 0,0705 m³
E27 max 1x60W

€ 180

205298 ■ Coffee

2200 K
500 lm

151717 € 6,00

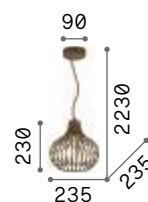

IP20

1,260 Kg / 0,0169 m³
E27 max 1x60W

€ 95

205281 ■ Coffee

2200 K
500 lm

151717 € 6,00



Ice

Rosone e montatura in metallo verniciato bianco o nero opaco. Copri porta lampade in metallo rifinito ottone satinato. Cavo elettrico in pvc.

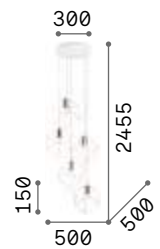

IP20

2,920 Kg / 0,0345 m³
E27 max 5 x 60W

€ 250

237671 ■ Bianco
237664 ■ Nero

3000 K
340 lm
101286 € 2,00



237671



237664

Citrus

Corpo luce con elementi multistrato di legno verniciato. Cavo in tessuto nero.

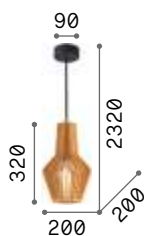

0,660 Kg / 0,0173 m³

E27 max 1x60W

€ 160

159843 Legno

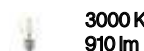

119571 € 3,50



0,720 Kg / 0,0242 m³

E27 max 1x60W

€ 170

159850 Legno

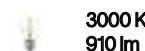

119571 € 3,50



0,510 Kg / 0,0148 m³

E27 max 1x60W

€ 140

159867 Legno

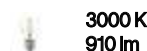

119571 € 3,50



Lugano

Rosone in metallo verniciato opaco. Cavo in tessuto con portalampade in metallo brunito. Diffusore in ceramica.

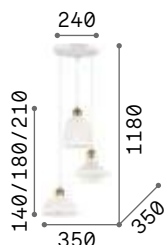

2,950 Kg / 0,0618 m³

E27 max 3x60W

€ 385

206875 Bianco

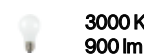

123899 € 3,50

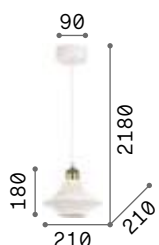

0,850 Kg / 0,0090 m³

E27 max 1x60W

€ 138

206806 Bianco

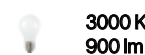

123899 € 3,50

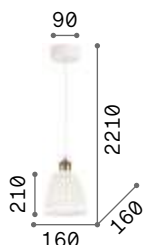

0,860 Kg / 0,0068 m³

E27 max 1x60W

€ 138

206820 Bianco

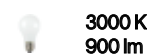

123899 € 3,50



Frida

Rosone e copriportalampada in metallo con finitura placcata o in vernice opaca. Cavo in tessuto nero.

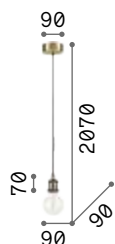

0,320 Kg / 0,0015 m³
E27 max 1x 60W

€ 40

139432 Cromo
139425 Nero
122106 Rame
122083 Brunito

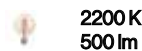

151717 € 6,00 P. 419



Edison

Rosone e copri porta lampada in metallo rifinito con vernice opaca bianca o nera. Cavo elettrico in tessuto.



Lampadine LED E27 8W Globo D125 trasparente 3000 K incluse.
Cod. 101347

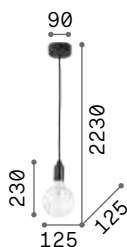

0,320 Kg / 0,0098 m³
E27 max 1x 42W

€ 60

113302 Bianco
113319 Nero

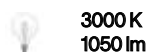

101347 € 6,00 P. 416





Mr Jack

Montatura e diffusore sferico in metallo rifinito in bianco, cromo o nero. Cavo elettrico rivestito in tessuto.

LED Lampadine LED GU10 7W 3000 K incluse. Cod. **123943**

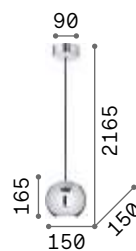

0,890 Kg / 0,0090 m³
GU10 max 1x28W

€ 80

231273 Bianco
116464 Cromo
231297 Nero

3000 K
540 lm

123943 € 3,50

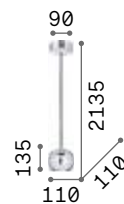

0,520 Kg / 0,0040 m³
GU10 max 1x28W

€ 70

231228 Bianco
116457 Cromo
231259 Nero

3000 K
540 lm

123943 € 3,50



Oil

Montatura in metallo con finitura nero opaco. Diffusore in cemento. Per il modello 110462 12 metri di cavo rivestito in tessuto e fornito con sei ganci di fissaggio e spina italiana che può essere sostituita al rosone.

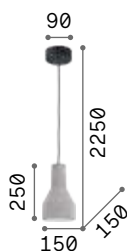

1,780 Kg / 0,0130 m³
E27 max 1x 15W

€ 116

110417 ■ Cemento

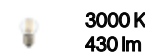

101279 € 2,00

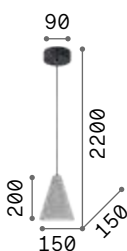

1,180 Kg / 0,0119 m³
E27 max 1x 15W

€ 116

110424 ■ Cemento

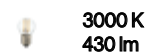

101279 € 2,00

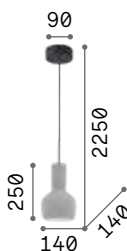

1,810 Kg / 0,0130 m³
E27 max 1x 15W

€ 116

110431 ■ Cemento

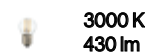

101279 € 2,00

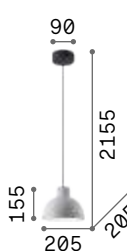

1,650 Kg / 0,0165 m³
E27 max 1x 15W

€ 116

129082 ■ Cemento

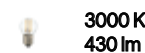

101279 € 2,00



1,760 Kg / 0,0236 m³
E27 max 1x 15W

€ 116

129099 ■ Cemento

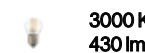

101279 € 2,00

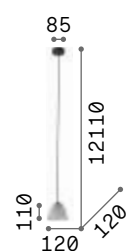

1,490 Kg / 0,0111 m³
GU10 max 1x 15W

€ 138

110462 ■ Cemento

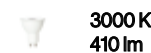

108292 € 3,00



Tall

Diffusore e dettagli in metallo verniciato bianco o nero opaco. Oltre 5 metri di cavo in PVC fornito con 6 ganci di fissaggio.

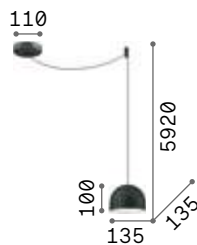

IP20

0,550 Kg / 0,0036 m³
E27 max 1x 42W

€ 135

196770 ■ Bianco
196787 ■ Nero

3000 K
340 lm

101286 € 2,00



196770



196787



A-Line

Rosone in metallo verniciato a polveri. Diffusore in metallo verniciato bianco o nero opaco con interno bianco. Cavo rivestito in tessuto.

LED Lampadine LED GU10 7W 3000 K incluse nei modelli: **232690** e **232713**. Cod. **123943**



232690



232713

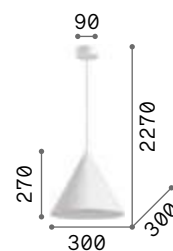

IP20

1,080 Kg / 0,0491 m³
E27 max 1x 60W

€ 85

232720 ■ Bianco
232744 ■ Nero

3000 K
900 lm

123899 € 3,50

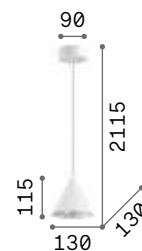

IP20

0,330 Kg / 0,0114 m³
GU10 max 1x 28W

€ 60

232690 ■ Bianco
232713 ■ Nero

3000 K
540 lm

123943 € 3,50



Diesis

Rosone e diffusore in metallo verniciato a polveri o placcato. Cavo in pvc nero. Colori: nero, nickel satinato oppure ottone satinato.

LED Sorgente luminosa LED 3000 K, 20.000 h di durata.

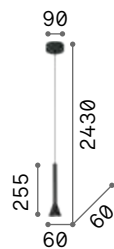

IP20

0,450 Kg / 0,0054 m³
LED 7W / 500 lm

€ 110

285122 ■ Nickel
279770 ■ Nero
279794 ■ Ottone



Archimede

Rosone in metallo verniciato a polveri con chiusura magnetica senza viti. Cavo in pvc. Diffusore in alluminio verniciato a polveri con ottica in acrilico. Finiture: bianco, nero.

LED Sorgente luminosa LED 3000 K, 50.000 h di durata.



310589



310596



310602

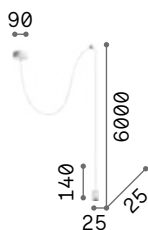

IP20

0,150 Kg / 0,0019 m³
LED 4W / 250 lm

€ 65

310589 ■ Bianco
328331 ■ Nero

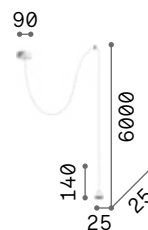

IP20

0,140 Kg / 0,0019 m³
LED 4W / 250 lm

€ 70

310596 ■ Bianco
328348 ■ Nero

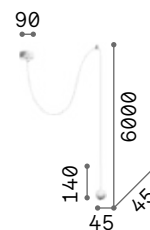

IP20

0,160 Kg / 0,0019 m³
LED 4W / 250 lm

€ 75

310602 ■ Bianco
328355 ■ Nero



Holly

Rosone e diffusori in metallo con finitura ottone spazzolato o verniciato a polveri con finitura bianca o nera. Cavi rivestiti in tessuto.

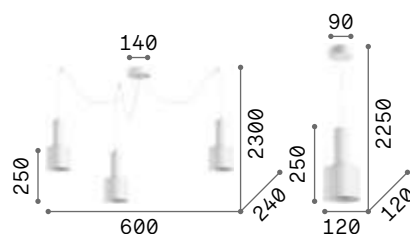

IP20

2,740 Kg / 0,0254 m³
E27 max 3 x 60W

€ 190

231587 Bianco
231594 Nero
231600 Ottone

IP20

0,780 Kg / 0,0064 m³
E27 max 1 x 60W

€ 75

231556 Bianco
231563 Nero
231570 Ottone



231556



231563



231570

3000 K
900 lm

123899 € 3,50

3000 K
900 lm

123899 € 3,50



Triade

Rosone e diffusore in metallo verniciato a polveri con interno bianco. Elemento decorativo a sfera dorato.

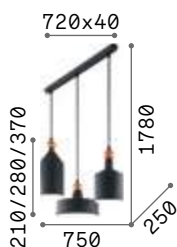

IP20

2,630 Kg / 0,0797 m³
E27 max 3 x 42W

€ 250

194677 ■ Grigio Scuro

3000 K
900 lm

123899 € 3,50

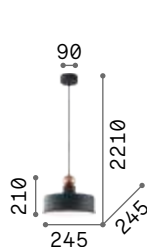

IP20

0,960 Kg / 0,0169 m³
E27 max 1 x 42W

€ 75

221489 ■ Grigio Scuro

3000 K
900 lm

123899 € 3,50

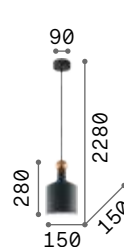

IP20

0,750 Kg / 0,0090 m³
E27 max 1 x 42W

€ 75

221496 ■ Grigio Scuro

3000 K
900 lm

123899 € 3,50

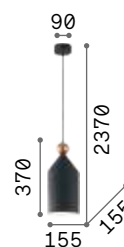

IP20

1,020 Kg / 0,0105 m³
E27 max 1 x 42W



€ 75

194684 ■ Grigio Scuro

3000 K
900 lm

123899 € 3,50



 
P. 290 P. 508

Mix Up

Rosone e paralumi intercambiabili in metallo verniciato a polveri. Cavo in PVC. Finiture: bianco oppure nero.



288406



288390

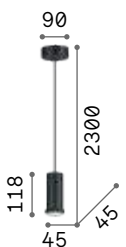

0,460 Kg / 0,0018 m³
E27 max 1x60W

€ 55

288406 ■ Bianco
288390 ■ Nero

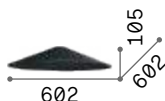

2,000 Kg / 0,0676 m³

€ 85

288437 ■ Bianco
288420 ■ Nero

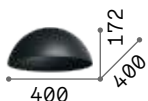

1,100 Kg / 0,0446 m³

€ 55

307404 ■ Bianco
288475 ■ Nero



0,800 Kg / 0,0147 m³

€ 40

307411 ■ Bianco
288444 ■ Nero

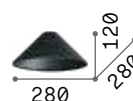

0,500 Kg / 0,0174 m³

€ 35

307428 ■ Bianco
288451 ■ Nero

 3000 K
900 lm
123899 € 3,50



Yurta

Rosone e paralume in metallo verniciato a polveri. Cavi rivestiti in tessuto. Colori: tutto bianco o nero con interno bianco.



285146



281568



IP20

1,760 Kg / 0,0687 m³
E27 max 1x60W

€ 110

285160 ■ Bianco
281582 ■ Nero

3000 K
900 lm

123899 € 3,50



IP20

1,000 Kg / 0,0277 m³
E27 max 1x60W

€ 80

285153 ■ Bianco
285139 ■ Nero

3000 K
340 lm

101286 € 2,00



IP20

0,740 Kg / 0,0138 m³
E27 max 1x60W

€ 70

285146 ■ Bianco
281568 ■ Nero

3000 K
340 lm

101286 € 2,00

Metro

Montatura e diffusore in metallo.
Interno smaltato in bianco. Cavo
elettrico regolabile in lunghezza.

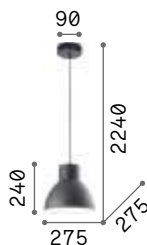

0,970 Kg / 0,0261 m³

E27 max 1x60W

€ 70

139098 ■ Grigio Scuro

3000 K
950 lm

101354 € 6,00



Breeze

Montatura e diffusore in metallo.
Interno smaltato in bianco. Cavo
elettrico regolabile in lunghezza.



3,490 Kg / 0,0707 m³

E27 max 1x60W

€ 195

232041 ■ Grigio Scuro

3000 K
950 lm

101354 € 6,00

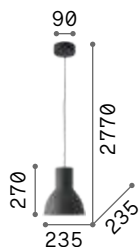

0,790 Kg / 0,0206 m³

E27 max 1x60W

€ 65

137681 ■ Grigio Scuro

3000 K
950 lm

101330 € 4,50





Moby

Montatura e diffusore in metallo con interno bianco. Disponibile nelle finiture bianco, nero o rame.



IP20

1,200 Kg / 0,0356 m³
E27 max 1x 42W

€ 127

102047 ■ Bianco
093659 ■ Nero
093697 ■ Rame

3000 K
950 lm
101330 € 4,50



Eris

Montatura in metallo con rosone e diffusore verniciati bianco o nero opaco, dettagli in finitura oro satinato. Cavo elettrico intrecciato con rivestimento in tessuto.



238104



249056

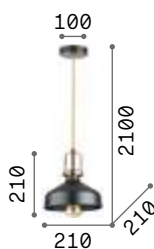

IP20

0,630 Kg / 0,0102 m³
E27 max 1x 42W

€ 75

238104 ■ Bianco
249056 ■ Nero

3000 K
340 lm

101286 € 2,00

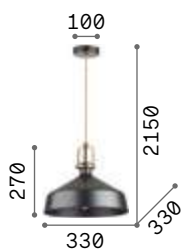

IP20

1,080 Kg / 0,0257 m³
E27 max 1x 42W

€ 86

238135 ■ Bianco
249063 ■ Nero

3000 K
950 lm

101330 € 4,50

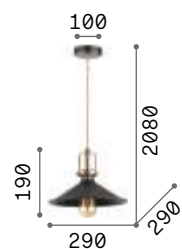

IP20

0,740 Kg / 0,0126 m³
E27 max 1x 42W

€ 75

238173 ■ Bianco
249070 ■ Nero

3000 K
340 lm

101286 € 2,00



IP20

0,960 Kg / 0,0231 m³
E27 max 1x 42W

€ 86

238210 ■ Bianco
249087 ■ Nero

3000 K
340 lm

101286 € 2,00



Fisherman

Corpo luce interamente in metallo con finitura in rame o in vernice nera opaca. Diffusore in lastra di vetro serigrafato bianco.



125831



134871



IP20

5,040 Kg / 0,0899 m³
E27 max 1x60W

€ 400

125831 ■ Nero
134871 ■ Rame

3000 K
1050 lm

101323 € 4,50



Cantina

Montatura, diffusore e copriportalampada in metallo disponibile con finitura brunito o rame. Cavo elettrico rivestito in tessuto e intrecciato.



112732

112701

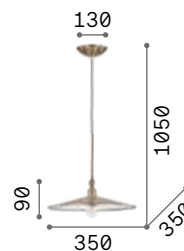

IP20

0,810 Kg / 0,0189 m³
E27 max 1x 42W

€ 100

112732 ■ Rame
112701 ■ Brunito



3000 K
910 lm

119571

€ 3,50



P. 426



Cono **new**

Rosone e montatura in metallo placcato. Diffusore in vetro soffiato trasparente. Cavo in pvc. Colori: Cromo con diffusore smerigliato, nickel o ottone.

LED Lampadine LED GU10 7W 3000 K incluse. Cod. **123943**



321462



321479



322803

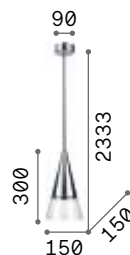

1,000 Kg / 0,0168 m³
GU10 max 1x28W

€ 80

321462 **Cromo** **new**

321479 **Ottone** **new**

322803 **Nickel** **new**

 3000 K
540 lm

123943 € 3,50



Kuky

Montatura in metallo cromato.
Disponibile con vetro pirex smerigliato a sabbia nella zona centrale.

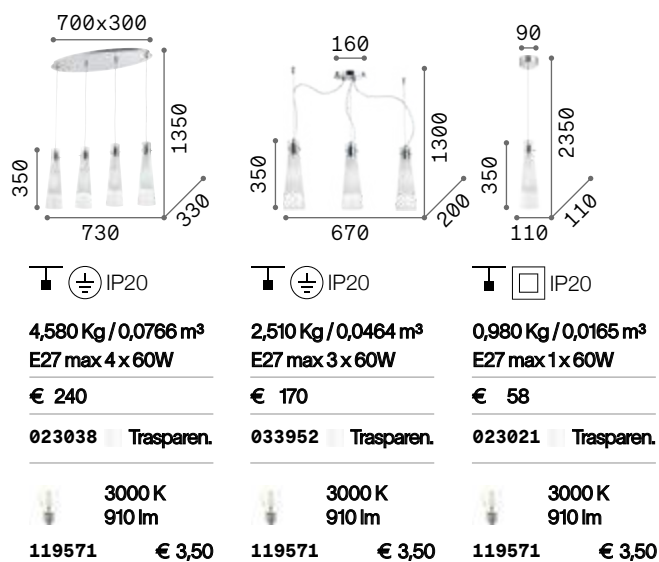



Milk

Base ellittica in metallo smaltato bianco. Diffusore in vetro bianco soffiato e acidato. Cavi elettrici regolabili in lunghezza.

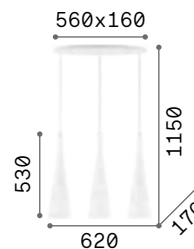

IP20

4,220 Kg / 0,1024 m³
E27 max 3 x 42W

€ 265

030326 Bianco

3000 K
900 lm

123899 € 3,50

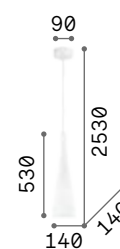

IP20

1,270 Kg / 0,0354 m³
E27 max 1 x 42W

€ 105

026787 Bianco

3000 K
900 lm

123899 € 3,50



Cocktail

Diffusore in vetro soffiato incamiciato e acidato. Bianco all'interno e colorato all'esterno. Sospensioni con cavi a lunghezza regolabile.

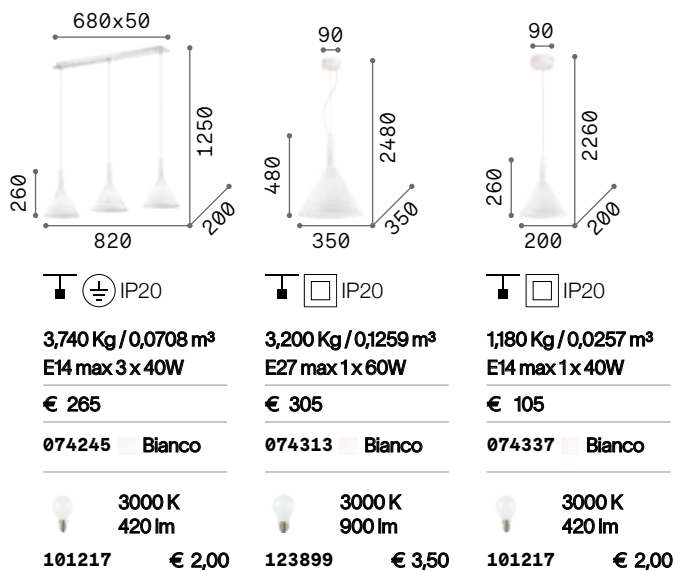



Manhattan

Rosone e diffusore in metallo rifinito con vernice opaca bianca o nera e con dettaglio in legno naturale. Cavo in tessuto.

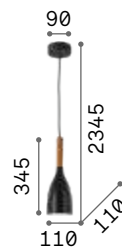

IP20

0,560 Kg / 0,0061 m³
E14 max 1x40W

€ 75

110745 ■ Bianco
110752 ■ Nero

3000 K
480 lm

101200 € 2,00



Flut

Diffusore in vetro soffiato incamiciato e acidato, bianco all'interno e colorato all'esterno. Cavo a lunghezza regolabile.

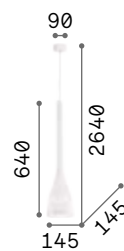

1,570 Kg / 0,0422 m³
E27 max 1x60W

€ 140

035666 ■ Bianco
035680 ■ Nero

3000 K
900 lm

123899 € 3,50

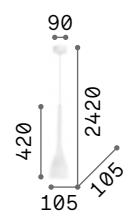

0,930 Kg / 0,0179 m³
E14 max 1x40W

€ 75

035697 ■ Bianco
035710 ■ Nero

3000 K
420 lm

101217 € 2,00



Origami

Montatura in metallo verniciato opaco. Diffusori in vetro bianco soffiato e acidato con effetto piegature in rilievo.

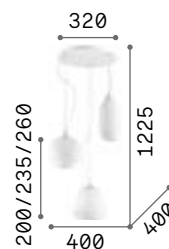

IP20

3,740 Kg / 0,0642 m³
E27 max 3 x 60W

€ 280

198095 Bianco

3000 K
900 lm

123899 € 3,50



Umile new

Rosone ed elementi decorativi in metallo con finitura oro satinato. Diffusori in vetro soffiato bianco acidato. Cavo in pvc nero.

LED Sorgente luminosa LED 3000 K, 20.000 h di durata.



IP20

8,600 Kg / 0,2150 m³
LED 55W / 5400 lm

€ 415

224541 Bianco

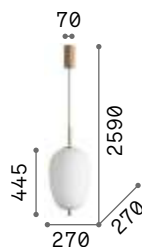

IP20

2,300 Kg / 0,0691 m³
LED 20W / 2050 lm

€ 170

314945 Bianco new

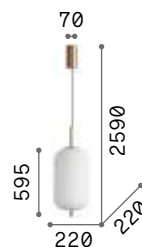

IP20

2,500 Kg / 0,0516 m³
LED 20W / 2050 lm

€ 160

314952 Bianco new



IP20

1,900 Kg / 0,0531 m³
LED 20W / 1950 lm

€ 140

314969 Bianco new

Blossom

Montatura e rosone in metallo cromato. Diffusore in vetro soffiato trasparente con finitura ambra o fumè. Cavo elettrico in pvc trasparente.

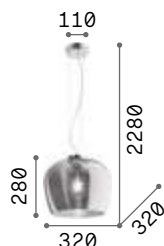

IP20

1,890 Kg / 0,0705 m³

E27 max 1x 60W

€ 175

241517 ■ Fumè

241524 ■ Ambra

3000 K
950 lm

101354 € 6,00



241517



241524



Lord

Rosone e montatura in metallo verniciato a polveri con finitura nera. Cavo in pvc nero. Diffusore in vetro soffiato con decori in rilievo. Disponibile con vetro ambra, trasparente o fumè.



IP20

1,430 Kg / 0,0389 m³

E27 max 1x 60W

€ 105

263632 ■ Trasparen.

263649 ■ Fumè

263656 ■ Ambra

3000 K
910 lm

119571 € 3,50





Fade

Rosone e montatura in metallo. Paralume in vetro soffiato trasparente con sfumatura galvanica. Diffusore interno in vetro soffiato bianco acidato. Cavo in pvc nero. Colori paralumi: trasparente con sfumatura ambra, cromo o rame.

LED Lampadine LED G9 3W 3000 K incluse. Cod. **209043**

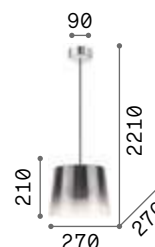

1,900 Kg / 0,0370 m³
G9 max 1x 15W

€ 200

271293 Cromo
271316 Ambra
271309 Rame

3000 K
510 lm
305486 € 6,00



Topico **new**

Rosone e montatura in metallo verniciato opaco. Diffusore con doppio vetro: interno bianco acidato, esterno trasparente con sfumatura fumè sulla parte superiore. Cavo in pvc nero. Colore: nero.

LED Sorgente luminosa LED 3000 K, 30.000 h di durata.

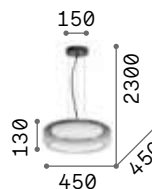

IP20

4,810 Kg / 0,1235 m³
LED 28W / 2450 lm

€ 250

333045 **Fumè** **new**



Karma

Montatura in metallo cromato.
 Diffusore in vetro soffiato bianco
 incamiciato e acidato. Cavi in
 acciaio a lunghezza regolabile da
 dispositivi ferma cavo automatici.

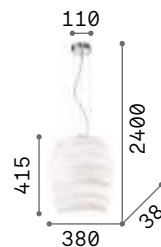

IP20

4,310 Kg / 0,1185 m³
 E27 max 1x60W

€ 200

132365 Bianco

3000 K
 950 lm

101354 € 6,00

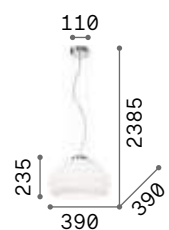

IP20

3,700 Kg / 0,0693 m³
 E27 max 1x60W

€ 200

132389 Bianco

3000 K
 950 lm

101354 € 8,00



Folk

Rosone e diffusore in metallo rifinito in vernice opaca con finitura coffee. Parabola interna ondulata e smaltata. Cavo in tessuto.

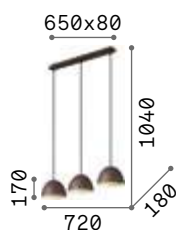

IP20

2,190 Kg / 0,0255 m³
E27 max 3 x 60W

€ 245

174235 Coffee

3000 K
340 lm

101286 € 2,00

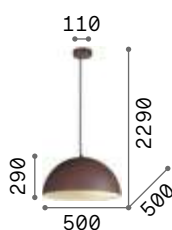

IP20

3,070 Kg / 0,0843 m³
E27 max 1 x 60W

€ 290

174228 Coffee

3000 K
950 lm

101354 € 6,00

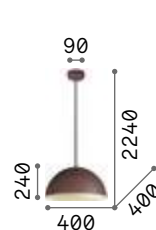

IP20

1,980 Kg / 0,0420 m³
E27 max 1 x 60W

€ 160

174211 Coffee

3000 K
950 lm

101330 € 4,50

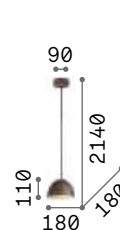

IP20

0,530 Kg / 0,0072 m³
E27 max 1 x 60W

€ 85

174204 Coffee

3000 K
900 lm

123899 € 3,50

Aria

Diffusore in vetro bianco soffiato e acidato. Cavi in acciaio a lunghezza regolabile con dispositivi ferma cavo automatici.

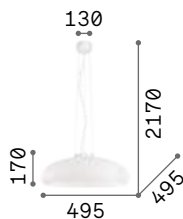

IP20

4,080 Kg / 0,0847 m³

E27 max 1x 60W

€ 285

059679 Bianco

3000 K
950 lm

101330 € 4,50



Plissè

Montatura in metallo placcato. Diffusore in vetro soffiato bianco acidato, con decoro in rilievo. Cavo elettrico in pvc trasparente. Colori: cromo oppure ottone satinato.

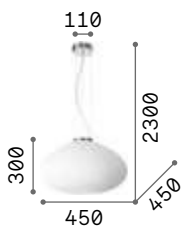

IP20

3,300 Kg / 0,1208 m³

E27 max 1x 60W

€ 250

264523 Cromo
285191 Ottone

3000 K
900 lm

123899 € 3,50



IP20

2,060 Kg / 0,0705 m³

E27 max 1x 60W

€ 185

285184 Cromo
264547 Ottone

3000 K
900 lm

123899 € 3,50



Lana

Diffusore in vetro trasparente con decorazioni serigrafate all'interno e sabbiate all'esterno. Ganci ferma vetro in metallo cromato.

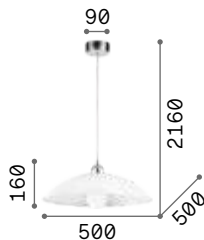

2,720 Kg / 0,0533 m³

E27 max 1x60W

€ 116

068169 Bianco

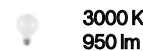

101330

€ 4,50



P. 298



Lena

Montatura in metallo cromato.
Diffusore con doppio vetro:
smerigliato e colorato quello
esterno, bianco quello interno.
Sospensioni con cavi in acciaio a
lunghezza regolabile da dispositivi
automatici.

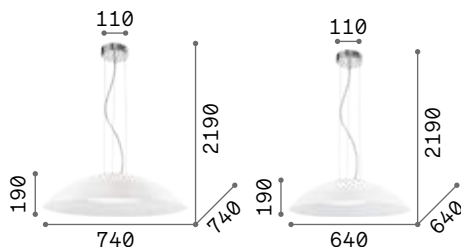

8,310 Kg / 0,1785 m³

E27 max 3x60W

€ 390

052786 Bianco

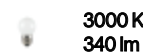

101286

€ 2,00



6,600 Kg / 0,1304 m³

E27 max 3x60W

€ 335

035727 Bianco

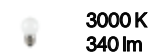

101286

€ 2,00





Smarties

Montatura in metallo verniciato bianco. Diffusore in vetro bianco soffiato. Cavi in acciaio a lunghezza regolabile con dispositivi ferma cavo automatici.

IP20	IP20	IP20
5,280 Kg / 0,1479 m³ E27 max 5 x 42W	3,740 Kg / 0,1009 m³ E27 max 3 x 42W	2,930 Kg / 0,0645 m³ E27 max 3 x 42W
€ 290	€ 200	€ 175
031996 Bianco	032009 Bianco	032016 Bianco
3000 K 340 lm	3000 K 340 lm	3000 K 340 lm
101286 € 2,00	101286 € 2,00	101286 € 2,00



P. 277 P. 385 P. 469



Glory

Rosone rifinito in nickel satinato. Diffusore in vetro bianco soffiato e acidato. Sospensioni con cavi in acciaio regolabili in lunghezza con dispositivi automatici.

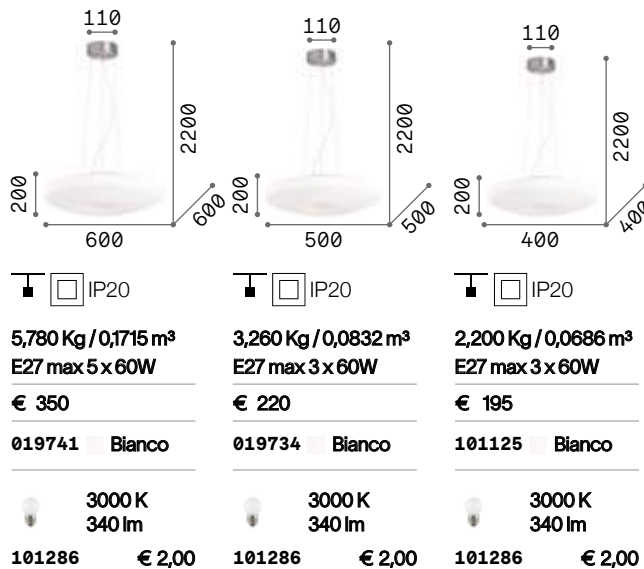

Ulisse

Montatura in metallo verniciato bianco opaco. Diffusore in vetro bianco soffiato e acidato. Sospensioni con cavi in acciaio a lunghezza regolabile da dispositivi automatici.

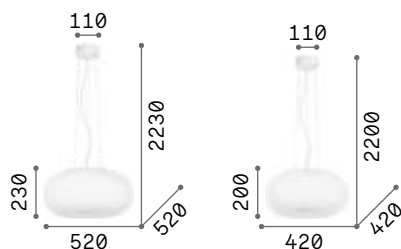

IP20

IP20

5,010 Kg / 0,1177 m³
E27 max 3 x 60W

3,110 Kg / 0,0720 m³
E27 max 3 x 60W

€ 295

€ 225

098616 Bianco

095226 Bianco

3000 K
910 lm

3000 K
910 lm

119571 € 3,50

119571 € 3,50



Arizona

Montatura in metallo rifinito in ottone satinato. Diffusore in vetro bianco soffiato, acidato e con rigature decorative in rilievo.

LED Lampadine LED GX53 9W 3000 K incluse. Cod. **123936**

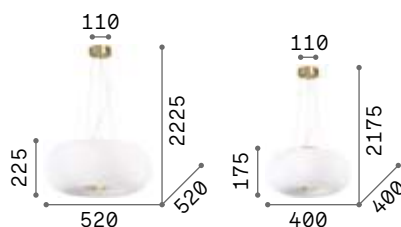

IP20

IP20

6,190 Kg / 0,1288 m³
GX53 max 5 x 9W

3,260 Kg / 0,0740 m³
GX53 max 3 x 9W

€ 520

€ 395

214481 Bianco

214474 Bianco

3000 K
910 lm

3000 K
910 lm

123936 € 5,00

123936 € 5,00



P. 278





Ovalino

Diffusore composto da elementi circolari in lastra di vetro curvata e acidata. Cavi in acciaio regolabili in lunghezza da dispositivi automatici.

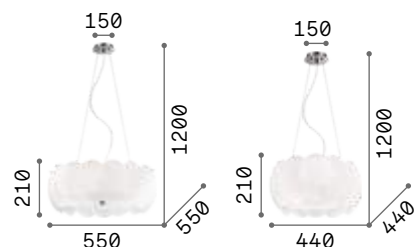

IP20

IP20

6,700 Kg / 0,1448 m³
E27 max 8 x 60W

4,810 Kg / 0,1184 m³
E27 max 5 x 60W

€ 325

€ 255

090481 Bianco

074139 Bianco

3000 K
900 lm

3000 K
900 lm

123899 € 3,50

123899 € 3,50



P. 284 P. 382



Candy

Montatura in metallo bianco.
 Diffusore in vetro bianco soffiato e acidato. Cavi in acciaio a lunghezza regolabile con dispositivi ferma cavo automatici.

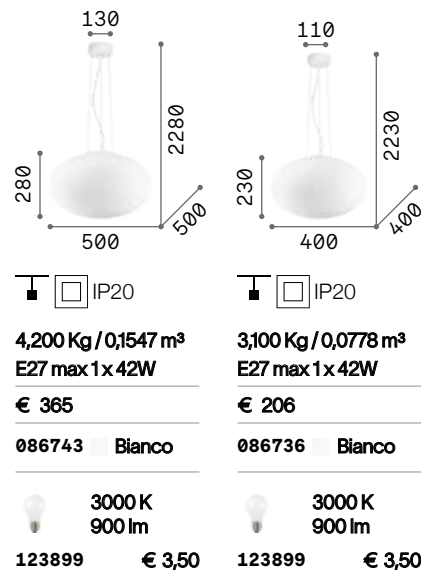



Cotton

Montatura e rosone in metallo rifinito con vernice a polveri di colore bianco con chiusura magnetica senza viti. Cavo in pvc trasparente. Diffusore in vetro soffiato bianco acidato.

LED Lampadine LED G9 3W 3000 K incluse nel modello **297781**. Cod. **209043**

2,600 Kg / 0,0810 m³ E27 max 1x42W	1,640 Kg / 0,0207 m³ E27 max 1x42W	0,600 Kg / 0,0068 m³ G9 max 1x4W
€ 200	€ 135	€ 70
327884 Bianco	297767 Bianco	297781 Bianco
3000 K 900 lm	3000 K 900 lm	3000 K 510 lm
123899 € 3,50	123899 € 3,50	305486 € 6,00



P. 281

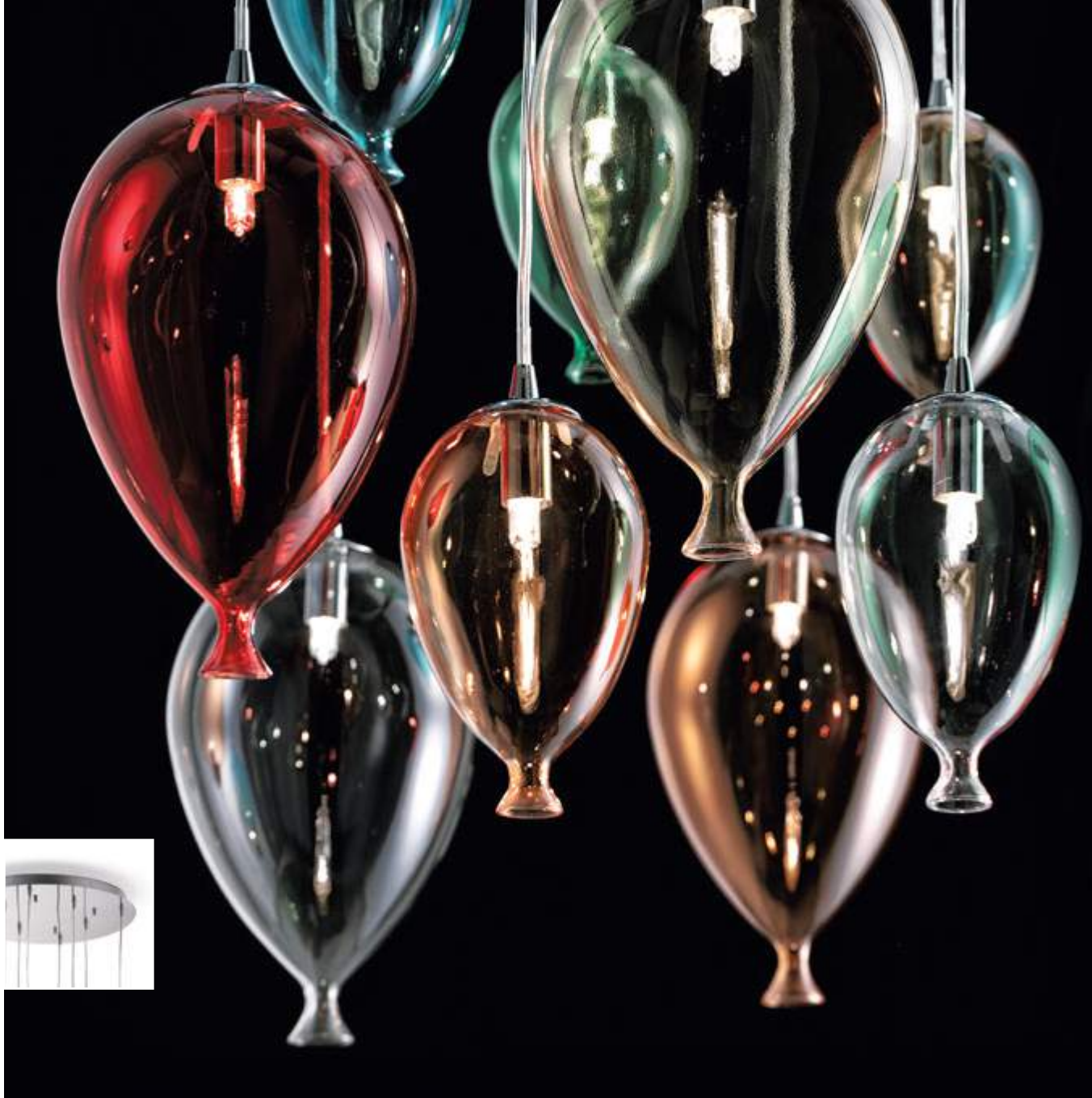

Clown

Montatura in metallo cromato.
Diffusori in vetro soffiato modellato
e colorato a mano. Cavi in teflon
trasparente.

LED

Lampadine LED G9 3W 3000 K incluse.
Cod. **209043**



100944



100883

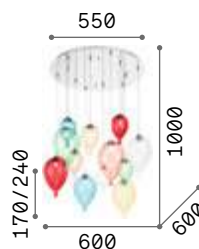

IP20

6,000 Kg / 0,1860 m³
G9 max 12 x 28W

€ 750

100951 Color

3000 K
510 lm

305486 € 6,00

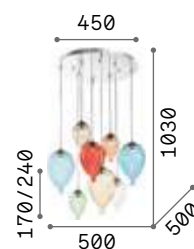

IP20

5,700 Kg / 0,1442 m³
G9 max 8 x 28W

€ 545

100944 Color

3000 K
510 lm

305486 € 6,00

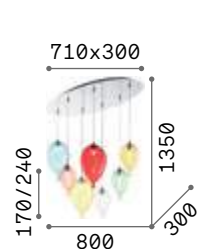

IP20

5,000 Kg / 0,1283 m³
G9 max 7 x 28W

€ 493

100937 Color

3000 K
510 lm

305486 € 6,00

Luce Max

Montatura in cromo. Diffusore in vetro soffiato con decorazione interna in filo d'alluminio.
Sospensioni con cavo in acciaio a lunghezza regolabile da dispositivo ferma cavo automatico.

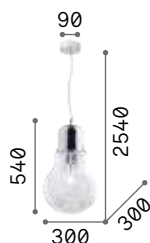

2,460 Kg / 0,0732 m³
E27 max 1x60W

1,500 Kg / 0,0334 m³
E27 max 1x60W

€ 120

€ 84

033662 Trasparen.

033679 Trasparen.

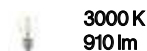
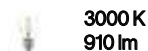

119571 € 3,50

119571 € 3,50

Mapa Max

Montatura in cromo. Diffusore in vetro soffiato con decorazione interna in filo d'alluminio.
Sospensioni con cavo in acciaio a lunghezza regolabile da dispositivo ferma cavo automatico.

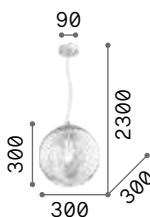
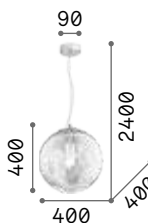

3,450 Kg / 0,1370 m³
E27 max 1x42W

1,370 Kg / 0,0527 m³
E27 max 1x42W

€ 166

€ 118

045122 Cromo

045115 Cromo

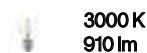
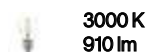

119571 € 3,50

119571 € 3,50





Mapa Plus

Montatura in metallo bianco.
Diffusore a sfera in vetro bianco
soffiato e acidato. Cavi in acciaio a
lunghezza regolabile.

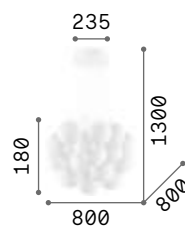

10,800 Kg / 0,1976 m³
E14 max 22 x 40W

€ 670

140230 Bianco

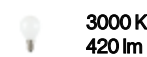

101217 € 2,00

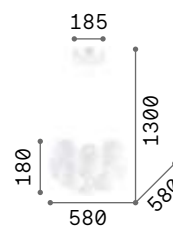

5,520 Kg / 0,1205 m³
E14 max 11 x 40W

€ 400

131924 Bianco

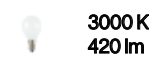

101217 € 2,00



Mapa mini ^{new}

Rosone in metallo verniciato opaco.
Cavo in pvc trasparente. Elemento reggi vetro in silicone trasparente opaco. Diffusore in vetro soffiato opaco. Finiture rosone: bianco, nero. Finiture vetro: ambra, fumé, satinato, trasparente, iride.

LED Sorgente luminosa LED 3000 K, 50.000 h di durata.



343631



343648

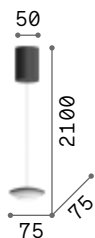

IP20

0,250 Kg / 0,0010 m³
LED 4W / 400 lm

€ 75

343631 **Bianco** ^{new}
343648 **Nero** ^{new}

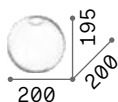

0,300 Kg / 0,0114 m³

€ 70

289786 **Trasparen** ^{new} 289861 **Trasparen** ^{new}
289939 **Bianco** ^{new} 327433 **Bianco** ^{new}
289908 **Fumè** ^{new} 327457 **Fumè** ^{new}
289915 **Ambra** ^{new} 327419 **Ambra** ^{new}
348698 **Iride** ^{new} 348681 **Iride** ^{new}

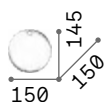

0,250 Kg / 0,0054 m³

€ 45

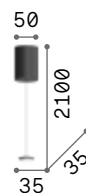

IP20

0,150 Kg / 0,0010 m³
LED 2W / 140 lm

€ 50

343617 **Bianco** ^{new}
343624 **Nero** ^{new}



0,200 Kg / 0,0020 m³

€ 30

289878 **Trasparen** ^{new}
327426 **Bianco** ^{new}
327440 **Fumè** ^{new}
327402 **Ambra** ^{new}
348674 **Iride** ^{new}



Mapa Clear new

Rosone e montatura in metallo cromato. Diffusore a sfera in vetro soffiato trasparente rifinito con cromatura sfumata verso il basso. Cavo in pvc trasparente. Colore: cromo, ambra, opale.



161327



346571



346625

161327	346571	161334	346557	346595
8,700 Kg / 0,2470 m³ E27 max 5x 42W	5,390 Kg / 0,2254 m³ E27 max 1x 42W	3,620 Kg / 0,1215 m³ E27 max 1x 42W	1,920 Kg / 0,0630 m³ E27 max 1x 42W	1,130 Kg / 0,0272 m³ E27 max 1x 42W
€ 640	€ 480	€ 270	€ 165	€ 95
140759 CromoStim. 346588 Ambra new 346632 Opale new	161327 CromoStim. 346571 Ambra new 346625 Opale new	161334 CromoStim. 346564 Ambra new 346618 Opale new	140728 CromoStim. 346557 Ambra new 346601 Opale new	140711 CromoStim. 346540 Ambra new 346595 Opale new
3000K 910lm	3000K 910lm	3000K 910lm	3000K 910lm	3000K 910lm
119571 € 3,50	119571 € 3,50	119571 € 3,50	119571 € 3,50	119571 € 3,50



Mapa

Montatura in metallo bianco.
Diffusore a sfera in vetro bianco soffiato e acidato. Cavi in acciaio a lunghezza regolabile.

LED Lampadine LED G9 3W 3000 K incluse nel modello **310800**. Cod. **209043**



310800

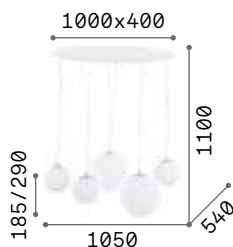

IP20

8,700 Kg / 0,2470 m³
E27 max 5 x 42W

€ 530

043562 Bianco

3000 K
910 lm

119571 € 3,50

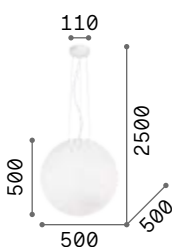

IP20

5,390 Kg / 0,2254 m³
E27 max 1 x 42W

€ 315

032122 Bianco

3000 K
910 lm

119571 € 3,50

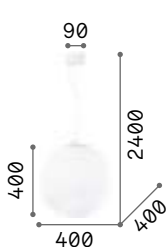

IP20

3,620 Kg / 0,1215 m³
E27 max 1 x 42W

€ 155

032139 Bianco

3000 K
910 lm

119571 € 3,50

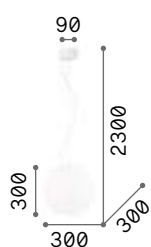

IP20

1,920 Kg / 0,0630 m³
E27 max 1 x 42W

€ 90

009087 Bianco

3000 K
910 lm

119571 € 3,50

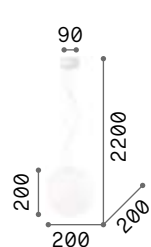

IP20

1,130 Kg / 0,0272 m³
E27 max 1 x 42W

€ 70

009148 Bianco

3000 K
910 lm

119571 € 3,50

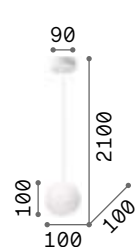

IP20

0,410 Kg / 0,0027 m³
G9 max 1 x 4W

€ 50

310800 Bianco

3000 K
510 lm

305486 € 6,00



Carta

Montatura in metallo verniciato bianco opaco. Diffusore in policarbonato con rivestimento ad effetto carta. Cavo rivestito in tessuto.

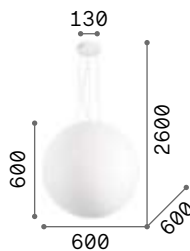

IP20

2,750 Kg / 0,2746 m³
E27 max 1x 60W

€ 475

272139 Bianco

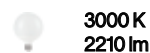

151786 € 6,00

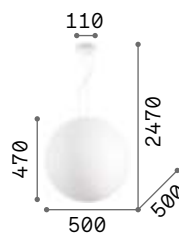

IP20

1,780 Kg / 0,1662 m³
E27 max 1x 25W

€ 360

226040 Bianco

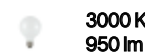

101330 € 4,50

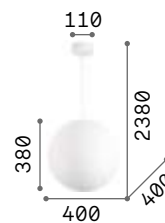

IP20

1,460 Kg / 0,0911 m³
E27 max 1x 25W

€ 225

226033 Bianco

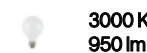

101330 € 4,50

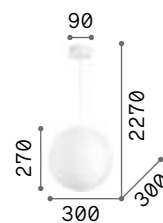

IP20

0,860 Kg / 0,0428 m³
E27 max 1x 25W

€ 110

226026 Bianco

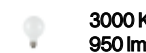

101330 € 4,50



P. 282 P. 385 P. 468 P. 519



Boa

Montatura in metallo verniciato opaco bianco o nero. Cavo in tessuto da 12 metri con 6 supporti. Diffusore in vetro soffiato bianco acidato.



160863



160856

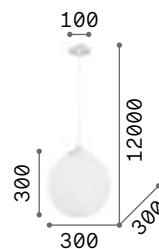

IP20

2,900 Kg / 0,0726 m³
E27 max 1x60W

€ 155

160863 ■ Bianco
160856 ■ Nero

3000 K
900 lm

123899 € 3,50



Nemo ^{new}

Diffusore in vetro soffiato.
Disponibile in versione fumè,
trasparente, rame, cromo sfumato
o ambra.



052809

149592

094236

250335

111902

339054

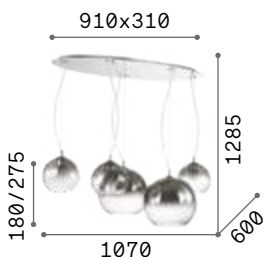

8,700 Kg / 0,2424 m³
E27 max 5 x 42W

€ 520

138305 CromoStum.

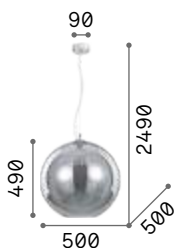

4,000 Kg / 0,2220 m³
E27 max 1 x 42W

€ 450

094137 Fumè

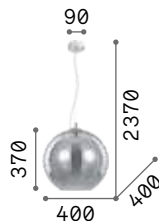

2,700 Kg / 0,1227 m³
E27 max 1 x 42W

€ 200

052816 Trasparen.
250359 CromoStum.
094229 Fumè
250342 Cromo
111919 Rame
339061 Ambra ^{new}

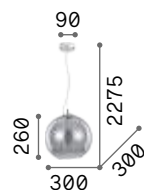

2,050 Kg / 0,0664 m³
E27 max 1 x 42W

€ 115

052809 Trasparen.
149592 CromoStum.
094236 Fumè
250335 Cromo
111902 Rame
339054 Ambra ^{new}

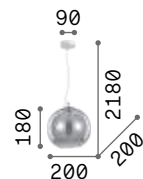

1,300 Kg / 0,0241 m³
E27 max 1 x 42W

€ 75

149585 CromoStum.
250311 Fumè
250304 Cromo
250328 Rame
339047 Ambra ^{new}

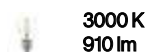

119571

€ 3,50

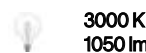

101347

€ 6,00

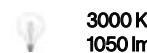

101347

€ 6,00



101323

€ 4,50



101323

€ 4,50



Dna

Rosone e montatura in metallo dorato. Diffusori in vetro incamiciato bianco, soffiato e acidato. Cavi d'acciaio regolabili.



Lampadine LED G9 3W 3000 K incluse.
Cod. **209043**

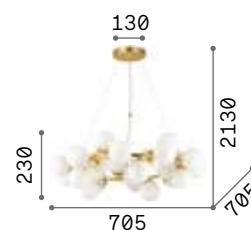

4,930 Kg / 0,2034 m³
G9 max 25 x 15W

€ **1110**

208398 Bianco

3000 K
510 lm

305486 € **6,00**



Nodi

Montatura in metallo cromato oppure in ottone satinato. Diffusori in vetro bianco soffiato, acidato o trasparente e cromato.



082073



241012



200491

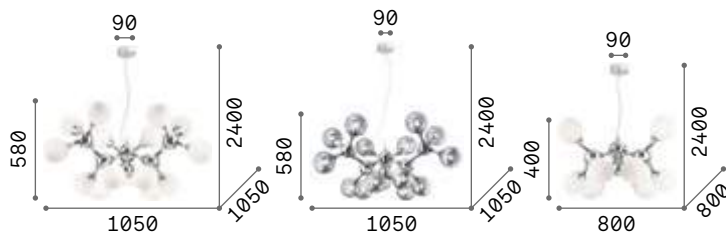

8,000 Kg / 0,3063 m³
E14 max 15 x 28W

€ 685

082073 Bianco
241012 Ottone



8,000 Kg / 0,4651 m³
E14 max 15 x 28W

€ 685

200491 Cromo



5,300 Kg / 0,1480 m³
E14 max 9 x 28W

€ 450

082059 Bianco
241036 Ottone



3000 K
480 lm

101200

€ 2,00



3000 K
480 lm

101200

€ 2,00



3000 K
480 lm

101200

€ 2,00



P. 322



Dream Big

Rosone in metallo verniciato bianco opaco. Cavo in tessuto. Diffusore in vetro soffiato bianco acidato. Cesto in corda.

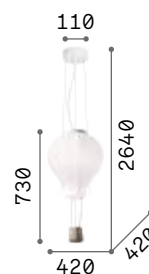

IP20

3,830 Kg / 0,1676 m³
E27 max 1x 42W

€ 265

261195 Bianco

3000 K
900 lm

123899 € 3,50

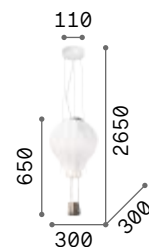

IP20

2,420 Kg / 0,1013 m³
E27 max 1x 42W

€ 155

179858 Bianco

3000 K
900 lm

123899 € 3,50



Avion

Corpo luce e rosone in legno dipinto con vernice opaca. Dettagli in metallo cromato. Diffusori in vetro soffiato bianco acidato.

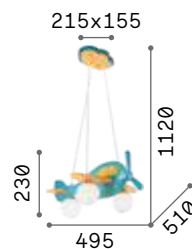

IP20

2,440 Kg / 0,0618 m³
E14 max 3 x 28W

€ 190

136325 ■ Azzurro
136318 ■ Rosso

3000 K
420 lm
101217 € 2,00



Lumiere

Montatura e rosone in metallo verniciato opaco con chiusura magnetica. Cavo in pvc trasparente. Diffusore tubolare centrale bianco. Elementi decorativi in vetro soffiato bianco lucido e trasparente grigio.

LED Sorgente luminosa LED 3000 K, 25.000 h di durata.

IP20	IP20	IP20
3,380 Kg / 0,0705 m³ LED 27W / 3550 lm	3,900 Kg / 0,0664 m³ LED 34W / 4550 lm	3,330 Kg / 0,0044 m³ LED 39W / 5050 lm
€ 280	€ 320	€ 320
314143 Bianco	314167 Bianco	314174 Bianco

P. 341
 P. 465
 P. 496



Empire

Montatura e rosone in metallo placcato color oro con chiusura magnetica senza viti. Cavo in pvc nero. Diffusore in vetro trasparente con sfumatura grigia.

LED Lampadine LED G9 3W 3000 K incluse.
Cod. **209043**

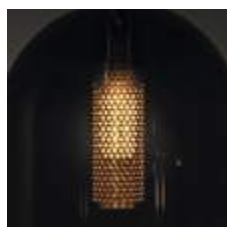

IP20 <small>INCLUSA</small>	IP20 <small>INCLUSA</small>	IP20 <small>INCLUSA</small>
0,600 Kg / 0,0194 m³ G9 max 1x28W	0,600 Kg / 0,0168 m³ G9 max 1x28W	0,600 Kg / 0,0206 m³ G9 max 1x28W
€ 100	€ 100	€ 100
309798 Cromo S.	309804 Cromo S.	309811 Cromo S.
3000 K 510 lm	3000 K 510 lm	3000 K 510 lm
305486 € 6,00	305486 € 6,00	305486 € 6,00



Soft

Montatura in metallo con finiture bianco e cromo. Diffusori in vetro soffiato bianco o fumè.



087818



111841

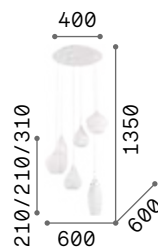

IP20

6,400 Kg / 0,1138 m³
E14 max 6 x 40W

€ 390

087818 ■ Bianco
111841 ■ Fumè

3000 K
420 lm

101217 € 2,00

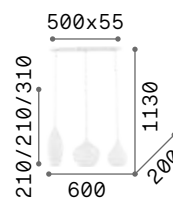

IP20

3,000 Kg / 0,0657 m³
E14 max 3 x 40W

€ 220

111858 ■ Bianco
111865 ■ Fumè

3000 K
420 lm

101217 € 2,00



Coco

Montatura in metallo verniciato a polveri con finitura nera. Diffusore in acrilico trasparente con bordo laterale satinato. Vetro soffiato trasparente con finitura fumè. Cavo in pvc.

LED Sorgente luminosa LED 3000 K, 20.000 h di durata.

IP20	IP20	IP20
1,200 Kg / 0,0128 m ³ LED 7W / 550 lm	1,140 Kg / 0,0132 m ³ LED 7W / 550 lm	1,080 Kg / 0,0152 m ³ LED 7W / 550 lm
€ 152	€ 152	€ 152
275567 ■ Fumè	275581 ■ Fumè	275543 ■ Fumè



Mint

Montatura in metallo con finitura ottone satinato e rosone nero opaco. Cavo rivestito in tessuto. Diffusore in vetro soffiato con rigatura in rilievo. Disponibile nelle finiture fumè o verde.



237510



237497

IP20	IP20	IP20
1,350 Kg / 0,0147 m³ E27 max 1x 60W	1,560 Kg / 0,0532 m³ E27 max 1x 60W	1,80 Kg / 0,0269 m³ E27 max 1x 60W
€ 105	€ 127	€ 138
237442 Fumè 248554 Verde	237398 Fumè 237428 Verde	237510 Fumè 237497 Verde
3000 K 910 lm	3000 K 910 lm	3000 K 910 lm
119571 € 3,50	119571 € 3,50	119571 € 3,50



Bergen

Rosone in metallo verniciato a polveri di colore nero. Montatura in legno naturale. Diffusore in vetro soffiato trasparente con motivo decorativo in rilievo e finitura fumè. Cavo rivestito in tessuto.

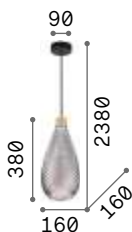

IP20

1,570 Kg / 0,0331 m³
E27 max 1x60W

€ 186

238838 ■ Fumè

3000 K
910 lm
119571 € 3,50



IP20

1,840 Kg / 0,0439 m³
E27 max 1x60W

€ 186

238920 ■ Fumè

3000 K
910 lm
119571 € 3,50



IP20

2,060 Kg / 0,0378 m³
E27 max 1x60W

€ 186

238746 ■ Fumè

3000 K
910 lm
119571 € 3,50



Bistrò

Montatura in metallo verniciato nero. Diffusore in vetro trasparente o fumè, soffiato e modellato artigianalmente.



112305



112312

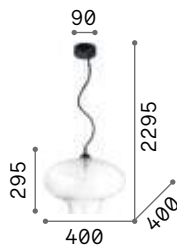

IP20

2,190 Kg / 0,0806 m³
E27 max 1x60W

€ 213

120898 Trasparen.
120904 Fumè

3000 K
910 lm

119571 € 3,50

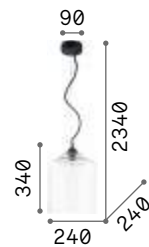

IP20

1,840 Kg / 0,0427 m³
E27 max 1x60W

€ 145

112305 Trasparen.
112312 Fumè

3000 K
910 lm

119571 € 3,50

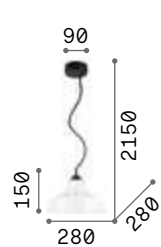

IP20

1,200 Kg / 0,0274 m³
E27 max 1x60W

€ 113

112336 Trasparen.
112343 Fumè

3000 K
910 lm

119571 € 3,50



Gretel

Montatura in metallo rifinito in vernice nera opaca con applicazione in legno naturale. Diffusori in vetro soffiato trasparente. Cavi in tessuto nero.



IP20

5,960 Kg / 0,1419 m³
E27 max 5 x 60W

€ 500

103174 ■ Nero

3000 K
910 lm
119571 € 3,50

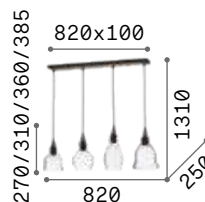

IP20

4,090 Kg / 0,0983 m³
E27 max 4 x 60W

€ 415

122557 ■ Nero

3000 K
910 lm
119571 € 3,50

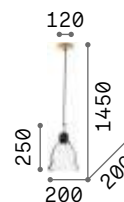

IP20

0,950 Kg / 0,0243 m³
E27 max 1 x 60W

€ 105

122564 ■ Nero

3000 K
910 lm
119571 € 3,50



Audi-10

Montatura in metallo cromato.
 Diffusore in vetro soffiato
 trasparente o fumè. Cavi in
 acciaio a lunghezza regolabile con
 dispositivi ferma cavo automatici.

LED Lampadine LED E27 8W Globo D95
 3000 K incluse. Cod. **101330/101323**



016863



103983

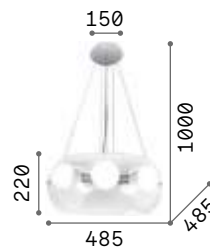

IP20

5,520 Kg / 0,1044 m³
E27 max 5 x 60W

€ 425

016863 **Trasparen.**
103983 **Fumè**

3000 K
950 lm

101330 € 4,50



Audi-80

Montatura in metallo cromato.
Elementi decorativi con sfere di vetro
su fili di metallo. Diffusore in vetro
soffiato trasparente o fumé. Cavi in
acciaio a lunghezza regolabile con
ferma cavo automatici.



031743



197661

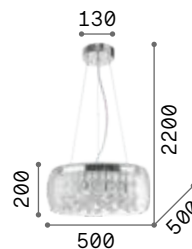

9,560 Kg / 0,1289 m³
G9 max 8 x 40W

€ 620

031750 Trasparen.
197654 Fumè

3000 K
510 lm

305486 € 6,00

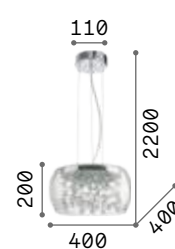

5,890 Kg / 0,0876 m³
G9 max 5 x 40W

€ 445

031743 Trasparen.
197661 Fumè

3000 K
510 lm

305486 € 6,00

LED

Lampadine LED G9 3W 3000 K incluse.
Cod. 209043



Madame

Rosone in metallo verniciato opaco bianco o nero. Cavo in tessuto. Diffusore con telaio metallico avvolto da nastro in tessuto di raso bianco, canvas o nero.



174396



219875



174402

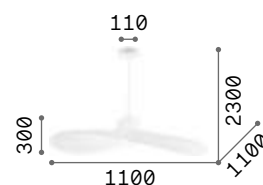

IP20

2,560 Kg / 0,2012 m³
E27 max 1x60W

€ 385

174396 ■ Bianco
219875 ■ Avorio
174402 ■ Nero

3000 K
950 lm

101354 € 6,00



Nordik

Montatura in metallo verniciato nero opaco. Paralume in lamina di PVC dorato rivestito in tessuto nero.

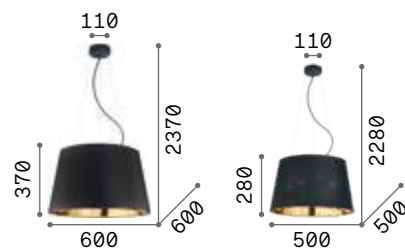

IP20

1,760 Kg / 0,1694 m³
E27 max 6x60W

€ 280

161662 ■ Nero

3000 K
910 lm

119571 € 3,50

IP20

1,500 Kg / 0,1064 m³
E27 max 4x60W

€ 210

161648 ■ Nero

3000 K
910 lm

119571 € 3,50



P. 436 P. 480 P. 532

Cylinder

Montatura in metallo. Diffusore in vetro soffiato bianco acidato. Cavi in acciaio a lunghezza regolabile con dispositivi ferma cavo automatici.

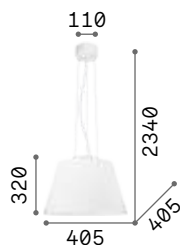

4,040 Kg / 0,0729 m³

E27 max 1x 60W

€ 235

025438 Bianco

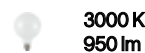

101354 € 6,00



P. 532



Haunt

Rosone in metallo verniciato bianco opaco. Cavo in tessuto. Diffusore con cesto in vimini al naturale o verniciato in bianco.

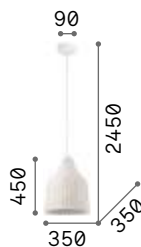

0,460 Kg / 0,0622 m³

E27 max 1x 60W

€ 180

159256 Bianco

159812 Legno

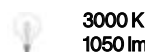

101347 € 6,00



159256



159812





Pan

Montatura in metallo. Diffusori con elementi decorativi a tubi metallici di diverse misure. Cavi d'acciaio regolabili.

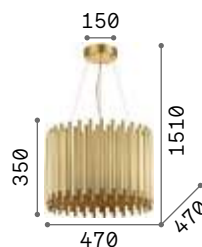

IP20

13,920 Kg / 0,1355 m³
E27 max 5 x 60W

€ 850

208817 Oro



3000 K
910 lm

119571

€ 3,50



P. 430



260457

304625

270012

260464

345895

Set up ^{new}

Montature in metallo verniciato a polveri o placcato. Paralumi in pvc ignifugo rivestito di tessuto. Colori montature: bianco, nero oppure nickel satinato o ottone spazzolato. Colori paralumi: beige, tortora, bianco, nero o legno.



2,000 Kg / 0,1384 m³

€ 172

345918 Bianco
 345932 Tortora
 345925 Nero
 339269 Beige
 339276 Legno

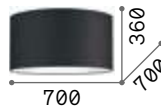

1,260 Kg / 0,0674 m³

€ 138

new 260471 Bianco
new 304632 Tortora
new 270029 Nero
new 260488 Beige
new 345901 Legno

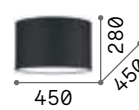

0,770 Kg / 0,0221 m³

€ 92

260457 Bianco
 304625 Tortora
 270012 Nero
 260464 Beige
new 345895 Legno

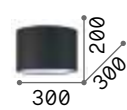

0,460 Kg / 0,0228 m³

€ 63

260433 Bianco
 304618 Tortora
 270005 Nero
 260440 Beige
new 345888 Legno *new*



260013



260020



260051



260044



IP20

1,200 Kg / 0,0081 m³
 E27 max 4 x 42W

€ 126

348230 Bianco
 348247 Nickel
 348254 Nero
 348261 Ottone



IP20

1,200 Kg / 0,0081 m³
 E27 max 4 x 42W

€ 126

new 348230 Bianco
new 348247 Nickel
new 348254 Nero
new 348261 Ottone



IP20

1,000 Kg / 0,0072 m³
 E27 max 3 x 42W

€ 102

new 348193 Bianco
new 348209 Nickel
new 348216 Nero
new 348223 Ottone



IP20

0,350 Kg / 0,0019 m³
 E27 max 1 x 42W

€ 30

new 260013 Bianco
new 260044 Nickel
new 260020 Nero
new 260051 Ottone

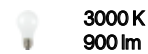

123899 € 3,50

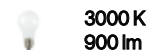

123899 € 3,50

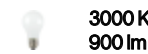

123899 € 3,50

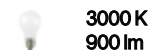

123899 € 3,50

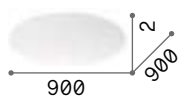

0,500 Kg / 0,0423 m³

€ 80

339252 Trasparen. *new*

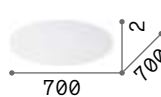

0,700 Kg / 0,0259 m³

€ 58

270050 Trasparen.

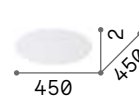

0,280 Kg / 0,0108 m³

€ 35

270043 Trasparen.

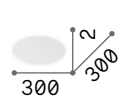

0,100 Kg / 0,0061 m³

€ 17

346847 Trasparen. *new*



339290

346045

346038

346014

346021

Set up Slim ^{new}

Montature in metallo verniciato a polveri o placcato. Paralumi in pvc ignifugo rivestito di tessuto. Colori montature: bianco, nero oppure nickel satinato o ottone spazzolato. Colori paralumi: beige, tortora, bianco, nero o legno.



1,200 Kg / 0,1903 m³

€ 138

- 346069 ■ Bianco new
- 339283 ■ Tortora new
- 346083 ■ Nero new
- 346052 ■ Beige new
- 346076 ■ Legno new



0,750 Kg / 0,1172 m³

€ 115

- 339290 ■ Bianco new
- 346045 ■ Tortora new
- 346038 ■ Nero new
- 346014 ■ Beige new
- 346021 ■ Legno new



0,440 Kg / 0,0415 m³

€ 80

- 345987 ■ Bianco new
- 346007 ■ Tortora new
- 345994 ■ Nero new
- 345970 ■ Beige new
- 339306 ■ Legno new



348193



348216



348223



348209



IP20

1,200 Kg / 0,0081 m³
E27 max 4 x 42W

€ 126

- 348230 ■ Bianco new
- 348247 ■ Nickel new
- 348254 ■ Nero new
- 348261 ■ Ottone new



IP20

1,200 Kg / 0,0081 m³
E27 max 4 x 42W

€ 126

- 348230 ■ Bianco new
- 348247 ■ Nickel new
- 348254 ■ Nero new
- 348261 ■ Ottone new



IP20

1,000 Kg / 0,0072 m³
E27 max 3 x 42W

€ 102

- 348193 ■ Bianco new
- 348209 ■ Nickel new
- 348216 ■ Nero new
- 348223 ■ Ottone new

3000 K
900 lm
123899 € 6,00

3000 K
900 lm
123899 € 6,00

3000 K
900 lm
123899 € 6,00



0,500 Kg / 0,0423 m³

€ 80

- 339252 ■ Trasparen. new



0,700 Kg / 0,0259 m³

€ 58

- 270050 ■ Trasparen.

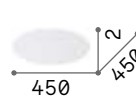

0,280 Kg / 0,0108 m³

€ 35

- 270043 ■ Trasparen.



346144

346168

346151

346137

339320

Set up Ultra Slim new

Montature in metallo verniciato a polveri o placcato. Paralumi in pvc ignifugo rivestito di tessuto. Colori montature: bianco, nero oppure nickel satinato o ottone spazzolato. Colori paralumi: beige, tortora, bianco, nero o legno.



0,800 Kg / 0,1124 m³

€ 126

- 346182 ■ Bianco new
- 346205 ■ Tortora new
- 339313 ■ Nero new
- 346175 ■ Beige new
- 346199 ■ Legno new



0,600 Kg / 0,0613 m³

€ 103

- 346144 ■ Bianco new
- 346168 ■ Tortora new
- 346151 ■ Nero new
- 346137 ■ Beige new
- 339320 ■ Legno new



0,500 Kg / 0,0265 m³

€ 69

- 339337 ■ Bianco new
- 346120 ■ Tortora new
- 346113 ■ Nero new
- 346090 ■ Beige new
- 346106 ■ Legno new



348193



348216



348223



348209



IP20

1,200 Kg / 0,0081 m³
E27 max 4 x 42W

€ 126

- 348230 ■ Bianco new
- 348247 ■ Nickel new
- 348254 ■ Nero new
- 348261 ■ Ottone new



IP20

1,200 Kg / 0,0081 m³
E27 max 4 x 42W

€ 126

- 348230 ■ Bianco new
- 348247 ■ Nickel new
- 348254 ■ Nero new
- 348261 ■ Ottone new

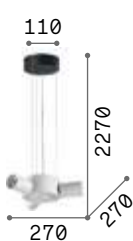

IP20

1,000 Kg / 0,0072 m³
E27 max 3 x 42W

€ 102

- 348193 ■ Bianco new
- 348209 ■ Nickel new
- 348216 ■ Nero new
- 348223 ■ Ottone new

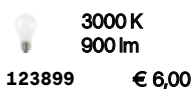

123899 € 6,00



123899 € 6,00

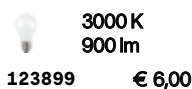

123899 € 6,00

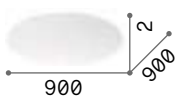

0,500 Kg / 0,0423 m³

€ 80

- 339252 ■ Trasparen. new

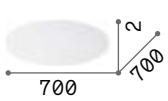

0,700 Kg / 0,0259 m³

€ 58

- 270050 ■ Trasparen.

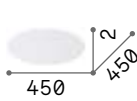

0,280 Kg / 0,0108 m³

€ 35

- 270043 ■ Trasparen.



Opera

Montatura in cromo. Paralume in lamina di PVC con riflessi metallizzati e rivestita da fili. Pendagli in cristallo molato. Sospensioni con cavi in acciaio a lunghezza regolabile.

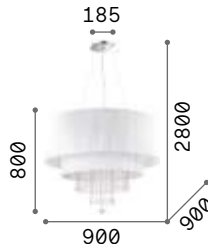

IP20

7,340 Kg / 0,3322 m³
E27 max 10 x 60W

€ 850

165011 Bianco



IP20

4,889 Kg / 0,1652 m³
E27 max 6 x 60W

€ 500

068299 Bianco

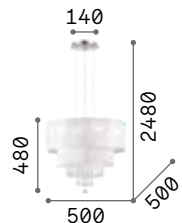

IP20

3,166 Kg / 0,0646 m³
E27 max 4 x 60W

€ 370

182179 Bianco

3000 K
900 lm
123899 € 3,50

3000 K
900 lm
123899 € 3,50

3000 K
900 lm
123899 € 3,50

P. 440 P. 486 P. 534



Swan

Montatura in cromo. Corpo luce in vetro soffiato e lavorato a mano. Elementi decorativi in cristallo molato. Paralume in tessuto d'organza plissettato. Copricatena in velluto.

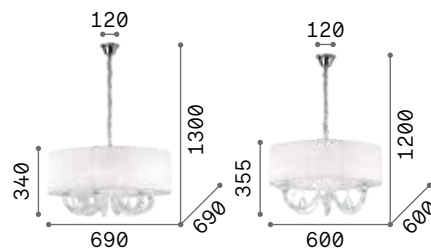

IP20

6,420 Kg / 0,2708 m³
E14 max 6x40W

€ 570

035826 Bianco

3000 K
420 lm

101217 € 2,00

IP20

4,770 Kg / 0,1632 m³
E14 max 3x40W

€ 400

035840 Bianco

3000 K
420 lm

101217 € 2,00





King

Diffusore composto da anelli in metallo cromato o dorato con ottagoni di cristallo incastonati all'interno. Sospensioni con cavi in acciaio a lunghezza regolabile da dispositivi automatici.

LED Lampadine LED G9 3W 3000 K incluse.
Cod. **209043**



088013



088020



P. 346

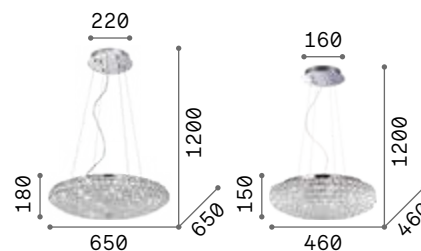

10,000 Kg / 0,1486 m³
G9 max 12 x 40W

€ 1050

088013 Cromo
088020 Oro

3000 K
510 lm

305486 € 6,00



5,300 Kg / 0,0748 m³
G9 max 7 x 40W

€ 670

087979 Cromo

3000 K
510 lm

305486 € 6,00



Rain

Montatura in metallo cromato.
 Pendagli con elementi in cristallo
 molato in varie forme e gocce finali.
 Sospensioni con cavi in acciaio a
 lunghezza regolabile.

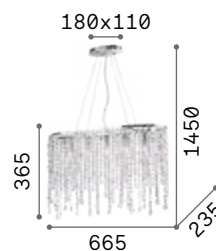

IP20

3,320 Kg / 0,0351 m³
 E14 max 5 x 40W

€ 350

008363 Cromo

3000 K
 470 lm

101224 € 2,00





Martinez

Montatura in metallo cromato o dorato. Elementi decorativi con catene di ottagoni e barre in cristallo molato trasparente.



166360



213583

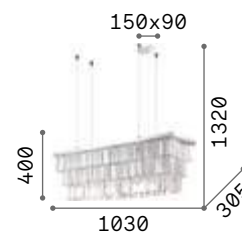

IP20

17,600 Kg / 0,1129 m³
E14 max 8 x 40W

€ 745

166360 Cromo
213583 Oro

3000 K
470 lm

101224 € 2,00





Carlton

Montatura in metallo cromato o dorato. Elementi decorativi con catene di ottagononi e barre in cristallo molato trasparente.



166247



213521

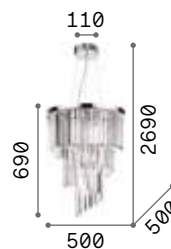

IP20

12,800 Kg / 0,1614 m³
E14 max 12 x 40W

€ 660

166247 Cromo
213521 Oro

101224 3000 K
470 lm

101224 € 2,00

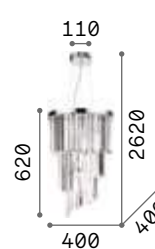

IP20

10,000 Kg / 0,1136 m³
E14 max 8 x 40W

€ 550

117737 Cromo

101224 3000 K
470 lm

101224 € 2,00



Nabucco

Montatura in metallo con finitura oro. Elementi decorativi in cristallo trasparente molato. Quadrati nella parte superiore e a losanga in quella inferiore. Copricatena in velluto.

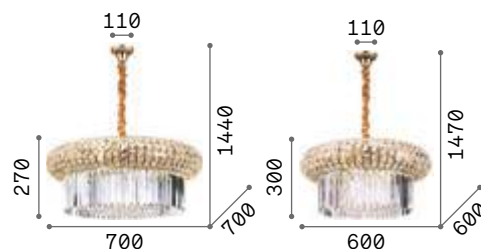

IP20

18,730 Kg / 0,2127 m³
E14 max 16 x 40W

€ 880

237800 Oro

3000 K
480 lm

101200 € 2,00

IP20

13,810 Kg / 0,1383 m³
E14 max 12 x 40W

€ 770

237794 Oro

3000 K
480 lm

101200 € 2,00



Pashà

Montatura in metallo. Diffusore composto da filari di perle in cristallo molato e fondo chiuso da vetro circolare sabbato. Cavi in acciaio a lunghezza regolabile con dispositivi fermacavo automatici.



164977



164984



P. 345 P. 438

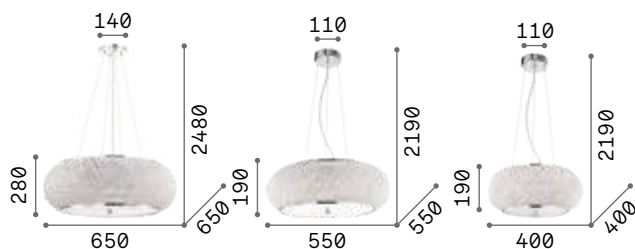

13,000 Kg / 0,1777 m³
E14 max 14 x 40W

€ 1210

164977 Cromo
164984 Oro

3000 K
480 lm

101200 € 2,00



8,500 Kg / 0,1134 m³
E14 max 10 x 40W

€ 950

082196 Cromo
082257 Oro

3000 K
480 lm

101200 € 2,00



5,350 Kg / 0,0573 m³
E14 max 6 x 40W

€ 750

082158 Cromo
082172 Oro

3000 K
480 lm

101200 € 2,00



Luxor

Montatura in metallo cromato.
Diffusore con elementi decorativi
ottagonali e rettangolari in cristallo
molato.

LED Lampadine LED G9 3W 3000 K incluse.
Cod. **209043**

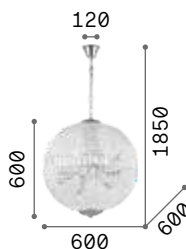

IP20 INCLUSA

12,250 Kg / 0,3097 m³
G9 max 12 x 40W

€ 1350

116235 Cromo

3000 K
510 lm
305486 € 6,00

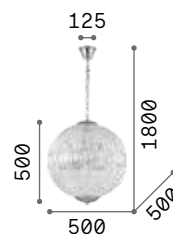

IP20 INCLUSA

8,780 Kg / 0,2054 m³
G9 max 8 x 40W

€ 950

116228 Cromo

3000 K
510 lm
305486 € 6,00

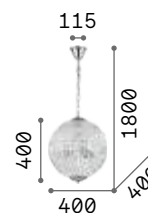

IP20 INCLUSA

8,340 Kg / 0,1260 m³
G9 max 6 x 40W

€ 750

092911 Cromo

3000 K
510 lm
305486 € 6,00



Evasione

Pendagli in cristallo molato.
Sospensioni con cavo in acciaio a
lunghezza regolabile da dispositivo
fermacavo automatico.

LED Lampadine LED G9 3W 3000 K incluse.
Cod. **209043**



7,100 Kg / 0,1082 m³
G9 max 10 x 40W

5,900 Kg / 0,0706 m³
G9 max 8 x 40W

€ 600

€ 500

044767 Cromo

044774 Cromo

3000 K
510 lm

3000 K
510 lm

305486 € 6,00

305486 € 6,00



Dubai

Montatura in metallo con finitura cromo o ottone. Elementi decorativi con perle, ottagoni e prismi in cristallo molato trasparente.



243597



243528



P. 353



P. 439

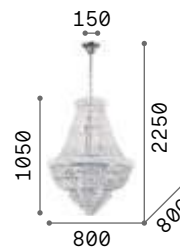

IP20

20,000 Kg / 0,8284 m³
E14 max 24 x 28W

€ 1650

243597 Cromo
243528 Ottone

3000 K
470 lm

101224 € 2,00

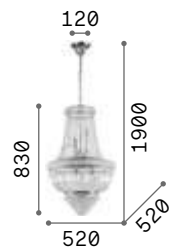

IP20

9,170 Kg / 0,2859 m³
E14 max 10 x 28W

€ 1050

215969 Cromo
207216 Ottone

3000 K
470 lm

101224 € 2,00



Caesar

Montatura in metallo con finitura in oro o cromo. Elementi decorativi in cristallo molato ottagonali con finali a puntale.

LED Lampadine LED G9 3W 3000 K incluse.
Cod. **209043**



114279



114743

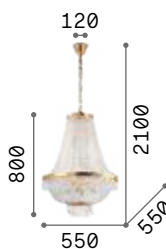

IP20 INCLUSA

9,600 Kg / 0,2965 m³
G9 max 12 x 4W

€ 1250

114279 Cromo
114743 Oro

3000 K
510 lm

305486 € 6,00



IP20 INCLUSA

6,700 Kg / 0,1936 m³
G9 max 9 x 4W

€ 975

041827 Cromo
114736 Oro

3000 K
510 lm

305486 € 6,00



IP20 INCLUSA

5,100 Kg / 0,1175 m³
G9 max 6 x 4W

€ 800

033532 Cromo
114729 Oro

3000 K
510 lm

305486 € 6,00



Millennium

Montatura e dettagli in metallo verniciato con effetto ruggine. Elementi decorativi centrali in legno naturale antichizzato.

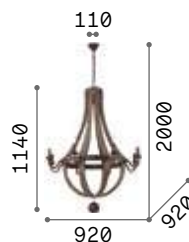

IP20

8,330 Kg / 1,0291 m³
E14 max 8 x 40W

€ 750

129709 ■ Legno

3000 K
470 lm

101224 € 2,00

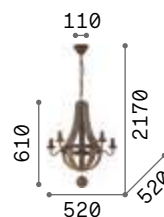

IP20

2,670 Kg / 0,2695 m³
E14 max 5 x 40W

€ 350

129921 ■ Legno

3000 K
470 lm

101224 € 2,00



Monet

Montatura in metallo con fasce circolari decorate a sbalzo. Catene con perle in legno naturale. Finitura con vernice opaca bianca.

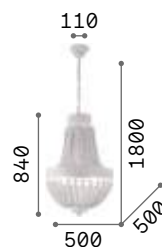

IP20

6,700 Kg / 0,0534 m³
E14 max 6 x 40W

€ 520

162751 Bianco

3000 K
420 lm

101217 € 2,00

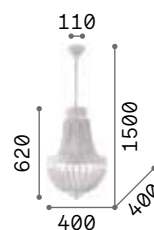

IP20

5,300 Kg / 0,0387 m³
E14 max 5 x 40W

€ 415

162737 Bianco

3000 K
420 lm

101217 € 2,00



Pegaso

Montatura in metallo cromato oppure ottone satinato. Corpo centrale, bobeches e pendagli in cristallo molato. Paralumi in organza. Copricatena in velluto.



059242



197739

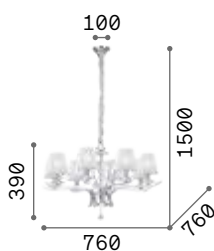

7,900 Kg / 0,2138 m³
E14 max 8 x 28W

€ 490

059242 Bianco
197739 Ottone

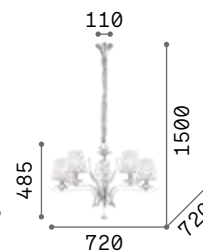

5,600 Kg / 0,1445 m³
E14 max 5 x 28W

€ 460

066448 Bianco
197722 Ottone



3,050 Kg / 0,0758 m³
E14 max 3 x 28W

€ 230

059235 Bianco
197715 Ottone

3000 K
370 lm
101231 € 2,00

3000 K
370 lm
101231 € 2,00

3000 K
370 lm
101231 € 2,00



Blanche

Montatura in metallo rifinito con smalto satinato bianco o nero. Paralumi in lamina di PVC rivestita di tessuto bianco o nero. Copricatena in velluto.

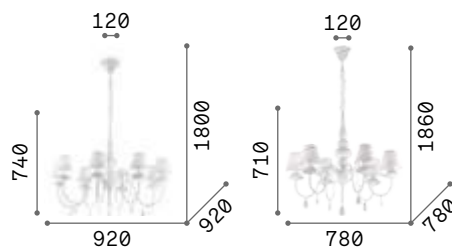

IP20

6,820 Kg / 0,1975 m³
E14 max 8 x 40W

€ 560

035574 ■ Bianco
111896 ■ Nero

3000 K
370 lm

101231 € 2,00

IP20

4,800 Kg / 0,1451 m³
E14 max 6 x 40W

€ 450

035581 ■ Bianco
111872 ■ Nero

3000 K
370 lm

101231 € 2,00



035581



111872



Corte

Montatura completamente in metallo modellato con lavorazione artigianale. Finitura dipinta a mano con effetto antichizzato. Disponibile nella versione bianca o ruggine.



005881



057187



P. 441

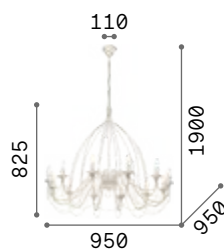

IP20

7,100 Kg / 0,6840 m³
E14 max 12 x 40W

€ 400

097664 ■ Bianco
097671 ■ Ruggine

3000 K
470 lm

101224 € 2,00

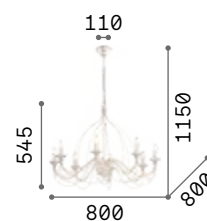

IP20

5,220 Kg / 0,3169 m³
E14 max 8 x 40W

€ 275

005898 ■ Bianco
057194 ■ Ruggine

3000 K
470 lm

101224 € 2,00

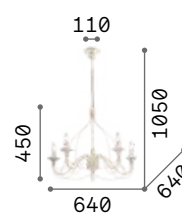

IP20

3,180 Kg / 0,1500 m³
E14 max 5 x 40W

€ 180

005881 ■ Bianco
057187 ■ Ruggine

3000 K
470 lm

101224 € 2,00



Colossal

Montatura e dettagli in metallo cromato. Bracci in vetro soffiato trasparente o con interno di colore grigio o bianco avorio. Pendagli ed elementi decorativi in vetro trasparente e cristallo molato. Copricatena in velluto.

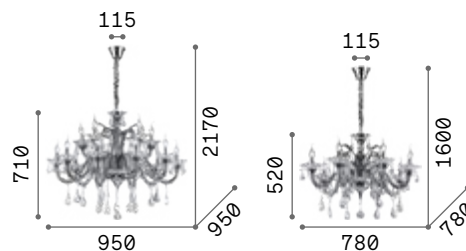

IP20

19,000 Kg / 0,2828 m³
E14 max 15 x 40W

€ 1000

114170 Trasparen.
081526 Grigio

 3000 K
470 lm

101224 € 2,00

IP20

11,400 Kg / 0,1386 m³
E14 max 8 x 40W

€ 800

114187 Trasparen.
081519 Grigio

 3000 K
470 lm

101224 € 2,00



114170



081526



Rose

Lampadario in vetro soffiato con dettagli in metallo cromato. Ottagoni e gocce in cristallo molato. Copricatena in velluto.

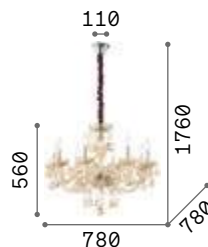

IP20

7,630 Kg / 0,1321 m³
E14 max 8 x 40W

€ 560

166889 Ambra

3000 K
430 lm

101248 € 2,00



Negresco

Montatura e dettagli in metallo placcato. Bracci in vetro soffiato trasparente con interno dorato. Elementi decorativi in vetro trasparente e cristallo molato. Copricatena in velluto. Colore: oro.



087771

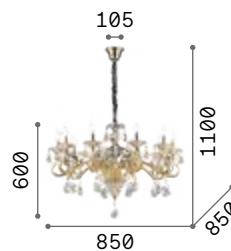

IP20

14,400 Kg / 0,1687 m³
E14 max 10 x 28W

€ 1000

087771 ■ Oro

3000 K
430 lm

101248 € 2,00

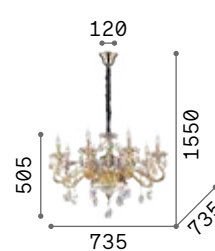

IP20

11,300 Kg / 0,1461 m³
E14 max 8 x 28W

€ 850

087764 ■ Oro

3000 K
430 lm

101248 € 2,00



P. 442



Amadeus

Montatura in metallo cromato.
Elementi decorativi in vetro soffiato
e cristallo molato. Copricatena in
velluto.

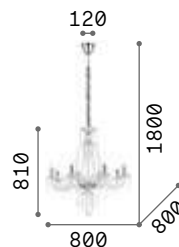

IP20

8,200 Kg / 0,1574 m³
E14 max 8 x 40W

€ 568

168777 Trasparen.

3000 K
470 lm

101224 € 2,00

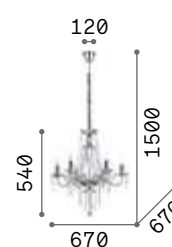

IP20

6,700 Kg / 0,1202 m³
E14 max 6 x 40W

€ 480

168753 Trasparen.

3000 K
470 lm

101224 € 2,00

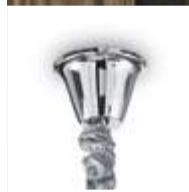

Florian

Montatura in metallo con elementi decorativi in vetro. Pendagli con ottagoni e gocce finali in cristallo molato. Disponibile nelle versioni con vetro trasparente e metallo dorato o cromato.



035604



035611

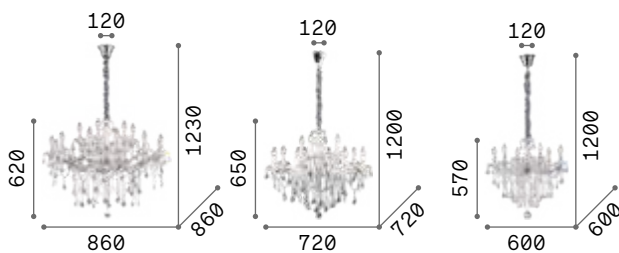

17,200 Kg / 0,3482 m³
E14 max 18 x 40W

€ 1000

075150 Cromo
075181 Oro



3000 K
470 lm

101224 € 2,00



9,760 Kg / 0,2187 m³
E14 max 12 x 40W

€ 650

035604 Cromo
035611 Oro



3000 K
470 lm

101224 € 2,00



6,380 Kg / 0,1368 m³
E14 max 6 x 40W

€ 510

035628 Cromo
035635 Oro



3000 K
470 lm

101224 € 2,00





Napoleon

Montatura in metallo cromato o dorato. Elementi decorativi in vetro soffiato e cristallo molato. Copricatena in velluto.



167244



167398

17,920 Kg / 0,4424 m ³ E14 max 18 x 40W	11,260 Kg / 0,2633 m ³ E14 max 12 x 40W	9,070 Kg / 0,2156 m ³ E14 max 8 x 40W
€ 1000	€ 635	€ 600
167268 Cromo 167411 Oro	167251 Cromo 167404 Oro	167244 Cromo 167398 Oro
3000 K 470 lm	3000 K 470 lm	3000 K 470 lm
101224 € 2,00	101224 € 2,00	101224 € 2,00



Gioconda

Corpo luce in fusione di metallo con finitura oro o argento antico. Pendagli ottagonali e tondi in cristallo molato. Copricatena in velluto.

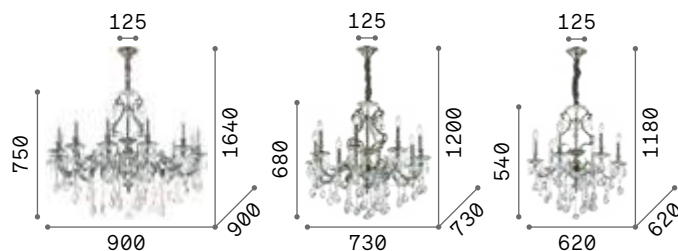

IP20

18,100 Kg / 0,1360 m³
E14 max 12 x 40W

€ 1400

164953 Argento
164960 Oro

3000 K
470 lm

101224 € 2,00

IP20

9,060 Kg / 0,0809 m³
E14 max 8 x 40W

€ 950

044934 Argento
060514 Oro

3000 K
470 lm

101224 € 2,00

IP20

6,340 Kg / 0,0682 m³
E14 max 6 x 40W

€ 725

044927 Argento
060507 Oro

3000 K
470 lm

101224 € 2,00



164953



164960



P. 443



Strauss

Montatura e dettagli in metallo con finitura oro. Bracci in vetro soffiato trasparente. Elementi decorativi in cristallo ambrato. Copricatena in velluto.



P. 443

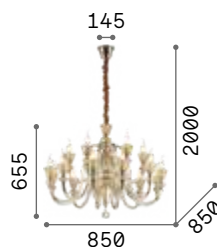

 IP20

20,700 Kg / 0,4508 m³
E14 max 18 x 40W

€ 1400

140629  Oro

 3000 K
430 lm
101248 € 2,00

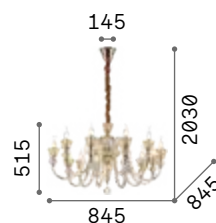

 IP20

14,930 Kg / 0,3414 m³
E14 max 12 x 40W

€ 1050

140612  Oro

 3000 K
430 lm
101248 € 2,00

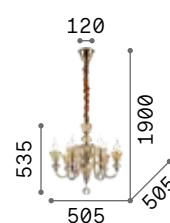

 IP20

7,410 Kg / 0,1420 m³
E14 max 6 x 40W

€ 575

140605  Oro

 3000 K
430 lm
101248 € 2,00



Casanova

Rosone, montatura e dettagli in metallo cromato. Elementi decorativi in vetro trasparente soffiato e lavorato a mano. Copri catena in velluto grigio.

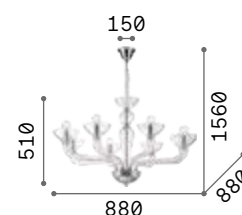

⏏ ⏏ IP20

9,210 Kg / 0,1592 m³
E14 max 8 x 40W

€ 750

044255 Trasparen.

3000 K
480 lm

101200 € 2,00



Doge

Rosone, montatura e dettagli in metallo cromato. Elementi decorativi in vetro trasparente soffiato e lavorato a mano. Cavo in pvc trasparente.

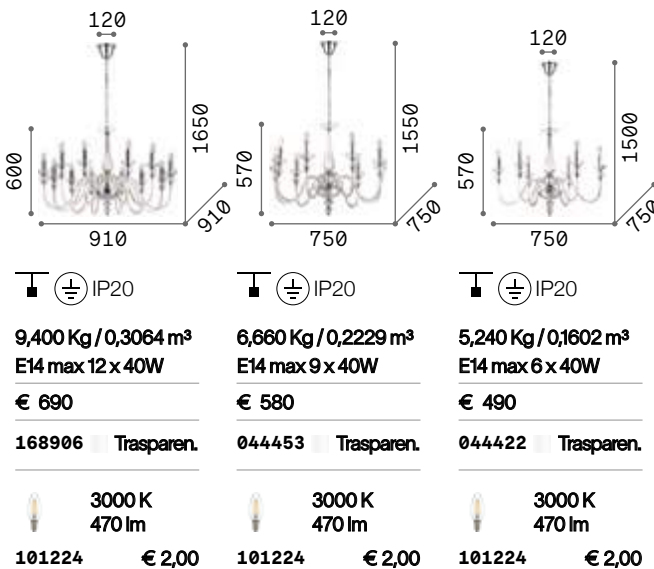



Danieli

Montatura e dettagli in metallo dorato. Elementi decorativi in vetro soffiato e modellato a mano. Copricatena in velluto. Colore: ambra.

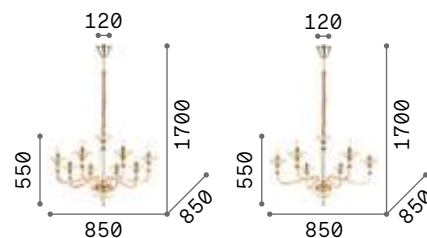

IP20

7,510 Kg / 0,2048 m³
E14 max 8 x 40W

€ 650

159973 Ambra

3000 K
480 lm

101200 € 2,00

IP20

3,840 Kg / 0,1759 m³
E14 max 6 x 40W

€ 600

159942 Ambra

3000 K
480 lm

101200 € 2,00





Brigitta

Lampadario in vetro soffiato trasparente o ambrato, lavorato artigianalmente con montatura in metallo e copricatena in velluto.



199382



199412

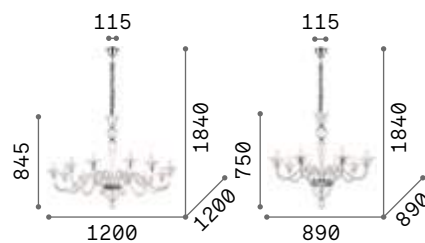

IP20

12,500 Kg / 0,2380 m³
E14 max 12 x 40W

€ 1000

199375 Trasparen.
199405 Ambra

3000 K
480 lm

101200 € 2,00

IP20

7,700 Kg / 0,1797 m³
E14 max 8 x 40W

€ 750

199382 Trasparen.
199412 Ambra

3000 K
480 lm

101200 € 2,00



Firenze

Corpo luce in resina. Bracci e foglie in metallo modellato artigianalmente. Decorato a mano con foglia d'oro e antichizzato.



012872



020839

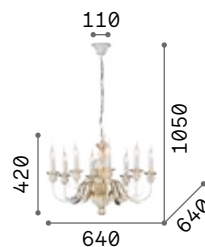

IP20

6,440 Kg / 0,0842 m³
E14 max 8 x 40W

€ 525

012872 Bianco
020839 Oro

3000 K
430 lm

101248 € 2,00

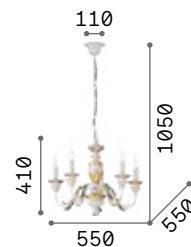

IP20

4,360 Kg / 0,0609 m³
E14 max 5 x 40W

€ 425

012865 Bianco
020822 Oro

3000 K
430 lm

101248 € 2,00



P. 444



P. 485



P. 535

Justine

Rosone e montatura in metallo con bracci in fusione. Rifinito con vernice opaca bianca. Copricatena in velluto.

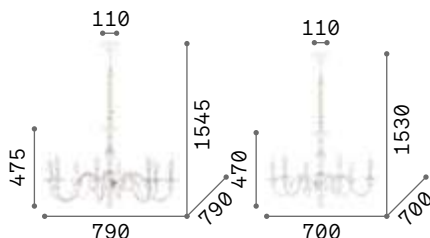

IP20

4,550 Kg / 0,3281 m³

E14 max 8 x 40W

€ 495

197524 Bianco

3000 K
430 lm

101248 € 2,00

IP20

3,440 Kg / 0,2592 m³

E14 max 6 x 40W

€ 390

197500 Bianco

3000 K
430 lm

101248 € 2,00



Bon Bon

Montatura con bracci in fusione di metallo verniciato opaco. Bobeche in vetro soffiato. Copri catena in velluto. Colore: bianco.

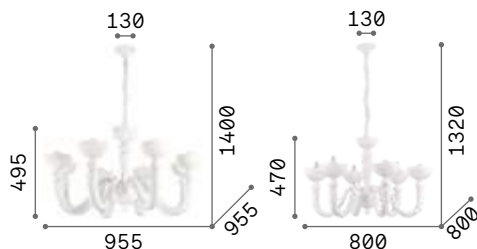

IP20

11,710 Kg / 0,1953 m³

E14 max 8 x 28W

€ 900

094007 Bianco

3000 K
420 lm

101217 € 2,00

IP20

8,110 Kg / 0,1547 m³

E14 max 6 x 28W

€ 630

093994 Bianco

3000 K
420 lm

101217 € 2,00



Vanity

Montatura in metallo dorato con dettagli nero opaco. Elementi decorativi in cristallo molato. Copricatena in velluto.

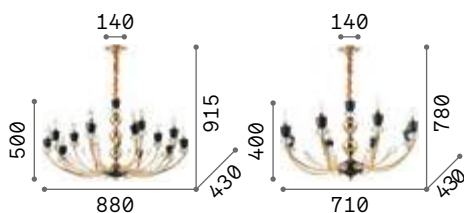

8,850 Kg / 0,2878 m³
E14 max 15 x 40W

€ 680

206639 Oro

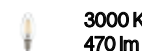

3000 K
470 lm

101224 € 2,00



4,940 Kg / 0,1454 m³
E14 max 8 x 40W

€ 420

206622 Oro

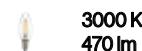

3000 K
470 lm

101224 € 2,00



Norma

Montatura in metallo con finitura in cromo o in brunito. Diffusore composto da lastre di vetro trasparente con bordo molato. Copricatena in velluto.

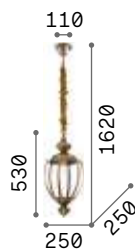

2,620 Kg / 0,0286 m³
E27 max 1 x 60W

€ 210

094786 Cromo
005911 Brunito

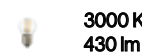

3000 K
430 lm

101279 € 2,00



094786

005911





Harem

Montatura con decori in rilievo in metallo brunito e ottagononi in cristallo molato incastonati. Diffusori in vetro soffiato trasparente leggermente ambrato con pendaglio a nappa. Copricatena in velluto.

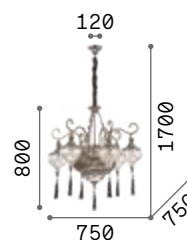

IP20

8,550 Kg / 0,2571 m³
E27 max 9x42W

€ 1175

116006 ■ Brunito

3000 K
910 lm

119571 € 3,50

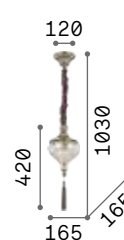

IP20

0,980 Kg / 0,0228 m³
E27 max 1x42W

€ 180

115979 ■ Brunito

3000 K
910 lm

119571 € 3,50



P. 446



Chalet

Montatura con struttura portante in metallo. Elementi decorativi in resina lavorata artigianalmente e dipinta a mano come fedele riproduzione di corna e legno intagliato.

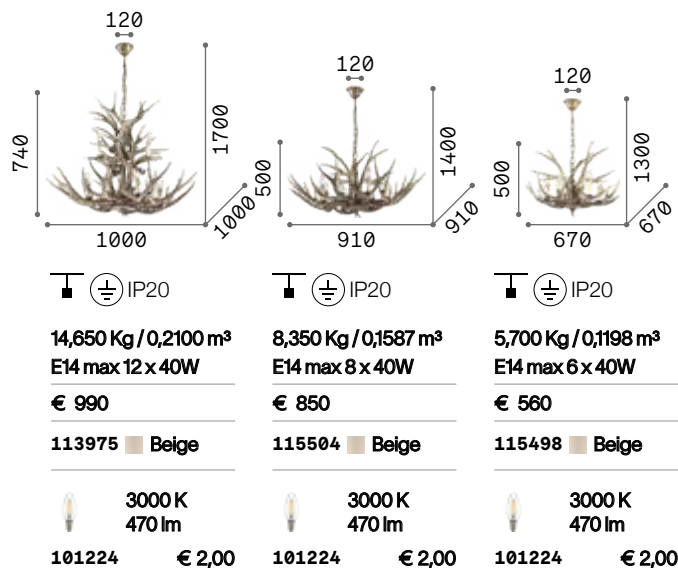

P. 444



P. 484

Canapa

Montatura in metallo verniciato.
Cavi elettrici e diffusori rivestiti in
corda di canapa naturale.

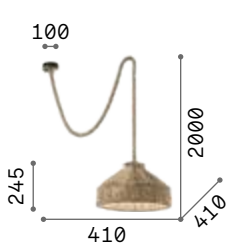

IP20

2,190 Kg / 0,0944 m³
E27 max 1x15W

€ 180

134833 ■ Corda

3000 K
910 lm

119571 € 3,50



IP20

0,650 Kg / 0,0063 m³
E27 max 2x15W

€ 60

134840 ■ Corda

3000 K
910 lm

119571 € 3,50

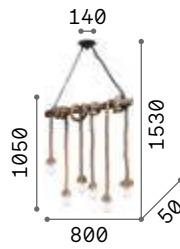

IP20

2,410 Kg / 0,0254 m³
E27 max 6x15W

€ 180

134826 ■ Corda

3000 K
910 lm

119571 € 3,50



Driftwood

Rosone in metallo. Struttura
sospesa di rami naturali. Copri
portalampade in metallo
spazzolato.

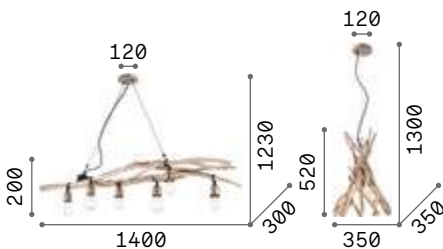

IP20

4,500 Kg / 0,1402 m³
E27 max 6x60W

€ 430

180922 ■ Legno

2200 K
370 lm

151687 € 2,50

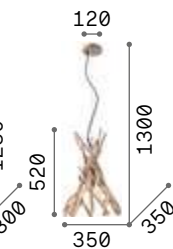

IP20

1,240 Kg / 0,0599 m³
E27 max 1x60W

€ 315

129600 ■ Legno

2200 K
370 lm

151687 € 2,50



P. 484 P. 526





Lampade da soffitto

Interni

Indice alfabetico

Admiral	347	Lana	298	Profilo	320
Angolo	334	Level	276	Rain	352
Arizona	278	Lika	311	Ray	260
Armony	348	Lingotto	335	Relax	268
Atlas	332	Look	300	Roma	344
Atrium	279	Lumiere	341	Royal	352
Binomio	337	Magnolia	353	Rudy	318
Birds	327	Mapa	282	Set Up	292
Candy	280	Maracas	330	Set Up Slim	294
Carlton	355	Martinez	354	Set Up Ultra Slim	296
Carta	282	Mix Up	290	Shell	299
Celine	270	Mood	307	Simply	298
Cloud	284	Moonlight	351	Sky	301
Compo	343	Mouse	316	Smarties	277
Corolla	285	Multiflex	328	Spike	308
Cosmopolitan	333	Neve	350	Spot	316
Cotton	281	Ninfea	339	Squish	271
Daisy	342	Nitro	302	Toby	313
Dubai	353	Nodi	322	Topico	283
Dynamite	312	Nodino	323	Totem	268
Fly	248	Oak	310	Tower	310
Frame	247	Oby	317	Triumph	326
Geko	275	Ocean	270	Universal R.	264
Gemini	272	Octopus	329	Universal S.	266
Gingle	274	Oracle Slim	242	Winery	315
Glim	321	Ovalino	284	Ziggy	286
Glory	276	Oz	244		
Gourmet	331	Pasha'	345		
Halo	258	Penta	340		
Hermes	338	Perlage	324		
Iride	269	Petit	314		
Karol	246	Ping Pong	336		
King	346	Planet	288		
Kubiko	306	Play	313		



Topico

Pag 283

new



Oracle Slim 242

new



Oz 244



Relax 268



Totem 268



Glory 276



Level 276

new



Topico 283



Ovalino 284

new



SetUp UltraSlim 296



Simply 298



Mood 307

new



Spike 308



Winery 315



Mouse 316



Perlage 324



Triumph 326

Lampade da soffitto

Indice icone

	<small>new</small> 	<small>new</small> 			<small>new</small> 	<small>new</small> 
Karol 246	Frame 247	Fly 248	Halo 258	Ray 260	Universal R. 264	Universal S. 266
			<small>new</small> 	<small>new</small> 		
Iride 269	Celine 270	Ocean 270	Squish 271	Gemini 272	Gingle 274	Geko 275
						
Smarties 277	Arizona 278	Atrium 279	Candy 280	Cotton 281	Mapa 282	Carta 282
						<small>new</small> 
Cloud 284	Corolla 285	Ziggy 286	Planet 288	Mix Up 290	Set Up 292	Set Up Slim 294
				<small>new</small> 		
Lana 298	Shell 299	Look 300	Sky 301	Nitro Round 302	Nitro Square 304	Kubiko 306
						
Oak 310	Tower 310	Lika 311	Dynamite 312	Play 313	Toby 313	Petit 314
						
Spot 316	Oby 317	Rudy 318	Profilo 320	Glim 321	Nodi 322	Nodino 323
						
Birds 327	Multiflex 328	Octopus 329	Maracas 330	Gourmet 331	Atlas 332	Cosmopolitan 333

Lampade da soffitto

Indice icone



Angolo 334



Lingotto 335



Ping Pong 336



Binomio 337



Hermes 338



Ninfea 339



Penta 340



Lumiere 341



Daisy 342



Compo 343



Roma 344



Pashà 345



King 346



Admiral 347



Armony 348



Neve 350



Moonlight 351



Royal 352



Rain 352



Magnolia 353



Dubai 353



Martinez 354



Carlton 355



Binomio

Pag 337

Oracle Slim new

Lampada da soffitto costituita da una montatura sottile in alluminio verniciato bianco o nero opaco e diffusore opale in policarbonato. Disponibile nel modello circolare in tre dimensioni diverse. LED integrati, disponibile in temperatura di colore 3000 K, CRI ≥ 90, durata utile LED 50.000 h, protezione IP20, classe isolamento II.

Sorgente	LED SMD	CRI	≥90
Potenza	29W / 37W / 53W	Durata LED	50.000 h
Driver incluso	On/Off	Classe	II
Driver disponibili	No	isolamento	
Angolo	115°	IP	20
CCT	2700 K / 3000 K / 4000 K	Materiale	Alluminio

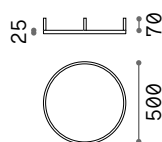

1,240 Kg/0,0455 m³

LED SMD Driver incluso

Dimensioni	Potenza	Driver	Lumen	CCT	Finitura	Codice	€
ø 500	29 W	On-Off	2850 lm	2700 K	Bianco	341897	195 <small>new</small>
					Nero	341880	195 <small>new</small>
			3000 lm	3000 K	Bianco	265971	195
					Nero	265988	195
			3400 lm	4000 K	Bianco	341910	195 <small>new</small>
					Nero	341903	195 <small>new</small>

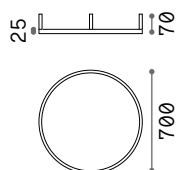

1,430 Kg/0,0852 m³

LED SMD Driver incluso

Dimensioni	Potenza	Driver	Lumen	CCT	Finitura	Codice	€
ø 700	37 W	On-Off	3800 lm	2700 K	Bianco	341934	260 <small>new</small>
					Nero	341927	260 <small>new</small>
			4250 lm	3000 K	Bianco	265995	260
					Nero	266008	260
			4350 lm	4000 K	Bianco	341958	260 <small>new</small>
					Nero	341941	260 <small>new</small>

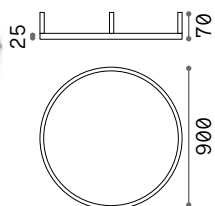

1,700 Kg/0,1345 m³

LED SMD Driver incluso

Dimensioni	Potenza	Driver	Lumen	CCT	Finitura	Codice	€
ø 900	53 W	On-Off	5150 lm	2700 K	Bianco	341972	295 <small>new</small>
					Nero	341965	295 <small>new</small>
			5200 lm	3000 K	Bianco	266015	295
					Nero	266022	295
			5350 lm	4000 K	Bianco	341996	295 <small>new</small>
					Nero	341989	295 <small>new</small>



P. 068



265971

265988

Oz new

Base e montatura in metallo verniciato a polveri o placcato. Diffusore in gomma opale. Disponibile nelle finiture bianco, nero o ottone spazzolato. Disponibile anche in versione dimmerabile DALI/Push.

LED Sorgente luminosa LED 2700 / 3000 / 4000 K, 30.000 h di durata.

Sorgente	LED SMD	Durata LED	30.000 h
Potenza	47W / 48W	Classe	II
Driver incluso	On/Off / DALI/Push	isolamento	
Driver disponibili	No	IP	20
CCT	2700 K / 3000 K / 4000 K	Materiale	Alluminio
CRI	≥90		

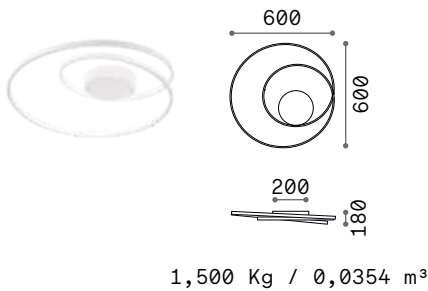

LED SMD Driver incluso

Potenza	Driver	Lumen	CCT	Finitura	Codice	€		
47 W	On-Off	5000 lm	2700 K	Bianco	342283	215 <small>new</small>		
				Nero	342290	215 <small>new</small>		
				Ottone	342306	215 <small>new</small>		
		5100 lm	3000 K	Bianco	253688	215		
				Nero	269412	215		
				Ottone	269429	215		
				5500 lm	4000 K	Bianco	342313	215 <small>new</small>
						Nero	342320	215 <small>new</small>
						Ottone	342337	215 <small>new</small>
48 W	DALI/Push	5100 lm	3000 K	Bianco	304519	370		
				Nero	304526	370		
				Ottone	304533	370		



253688



269412



269429



Karol

Corpo luce in metallo verniciato bianco opaco. Diffusore in materiale plastico colore opale.



Sorgente luminosa LED 4000 K, 50.000 h di durata.



3,430 Kg / 0,185 m³
LED 99W / 11000 lm

€ 515

227832 Bianco

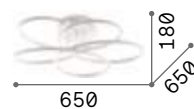

2,300 Kg / 0,0901 m³
LED 78W / 9450 lm

€ 375

227825 Bianco

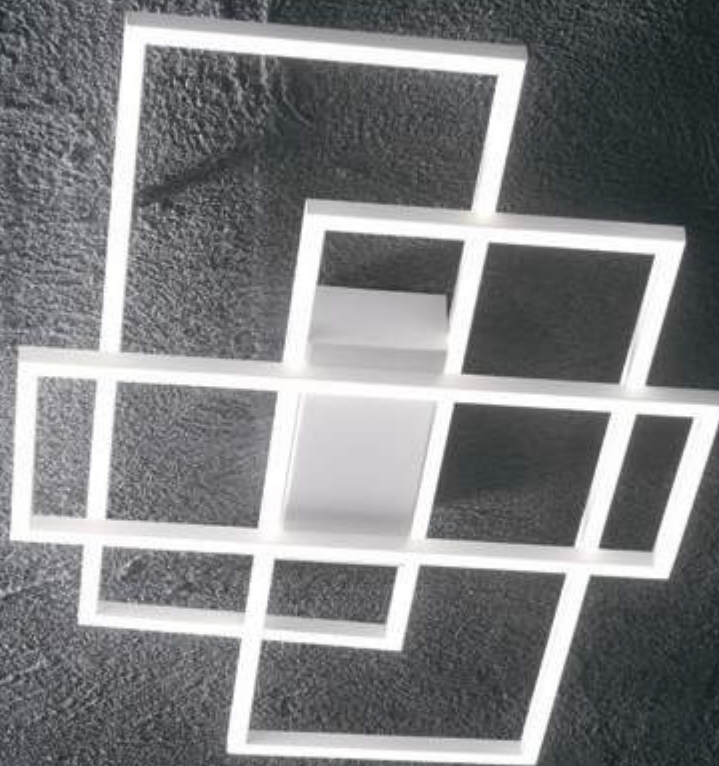

Frame ^{new}

Base e montatura in metallo verniciato bianco opaco o nero opaco. Diffusori in materiale plastico colore opale. Emissione luce diretta.

LED Sorgente luminosa LED 2700/3000 K, 30.000 h di durata.

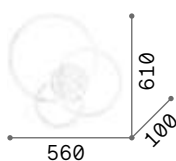

1,600 Kg / 0,0458 m³
LED 41W / 4550 lm / 5000 lm

€ 320

341309 Bianco 2700K^{new}
255019 Bianco 3000K
269825 Nero 3000K

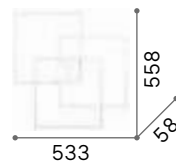

1,430 Kg / 0,0530 m³
LED 33W / 3800 lm / 4200 lm

€ 320

341316 Bianco 2700K^{new}
230702 Bianco 3000K
270678 Nero 3000K

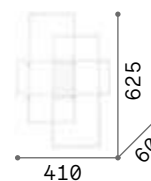

1,260 Kg / 0,0241 m³
LED 33W / 3400 lm / 3850 lm

€ 290

341323 Bianco 2700K^{new}
230726 Bianco 3000K
270661 Nero 3000K



P. 076



P. 501

Fly new

Famiglia di lampade a plafone con base circolare, disponibile in quattro diametri diversi (350 mm, 450 mm, 600 mm, 900 mm) oltre che nella variante SLIM dall'altezza più compatta. Corpo luce in alluminio verniciato a polveri in finitura bianco RAL 9016 e nero RAL 9004, ottica arretrata (FLY PL) oppure a filo (FLY SLIM) con diffusore in PMMA microprismatizzato con controllo dell'abbagliamento (UGR < 19). La lampada è predisposta per essere integrata con il modulo accessorio uplight per la componente di illuminazione indiretta. Sorgente luminosa a LED integrati; disponibile in temperatura di colore 2700 K, 3000 K e 4000 K; indice di resa cromatica CRI ≥ 90, binning iniziale ≤ 3Step MacAdam; durata utile LED 50.000 h; protezione IP40, classe isolamento I. Driver incluso, integrato nel corpo illuminante, disponibile in versione dimmerabile 1-10V, DALI e Push. Sistema adatto per ambienti dove richiesta un'illuminazione professionale e uniforme, ad esempio UFFICI e spazi COMMERCIALI. L'elevata resa cromatica lo rende ideale anche per gli spazi espositivi e la valorizzazione della merce in showroom e aree vendita nel settore RETAIL.

PRO

Prodotto ad alto contenuto tecnologico, elevata qualità dei materiali, destinato ad uso professionale.

IP40

Grado di protezione IP40.

Sorgente	LED SMD
Potenza	18W / 26W / 53W / 68W
Driver incluso	On/Off
Driver disponibili	1-10V / DALI / Push
MacAdam	SDCM 3
CCT	2700 K / 3000 K / 4000 K
CRI	≥90
UGR	<19
Durata LED	50.000 h
Classe isolamento	I
IP	40
Materiale	Alluminio
Garanzia	5 anni





Fly

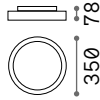

3,000 Kg/0,0160 m³

LED SMD SAMSUNG Driver TRIDONIC ON/OFF incluso

Potenza	Angolo	Lumen	CCT	Finitura	Codice	€
18 W	87°	2150 lm	2700 K	Bianco	341149	315 <small>new</small>
				Nero	341156	315 <small>new</small>
		2800 lm	3000 K	Bianco	270272	315
				Nero	306575	315
		3000 lm	4000 K	Bianco	270289	315
				Nero	306582	315

DIMMABLE DRIVER Non incluso/Optional

	Potenza	Output	Misura	Codice	€
1-10V/Push	20 W	500 mA	108 x 22 x 52 mm	270333	65
DALI	20 W	500 mA	108 x 22 x 52 mm	270364	85

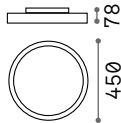

3,700 Kg/0,0250 m³

LED SMD SAMSUNG Driver TRIDONIC ON/OFF incluso

Potenza	Angolo	Lumen	CCT	Finitura	Codice	€
26 W	87°	3000 lm	2700 K	Bianco	341163	420 <small>new</small>
				Nero	341170	420 <small>new</small>
		3900 lm	3000 K	Bianco	254272	420
				Nero	306599	420
		4300 lm	4000 K	Bianco	270296	420
				Nero	306605	420

DIMMABLE DRIVER Non incluso/Optional

	Potenza	Output	Misura	Codice	€
1-10V/Push	32 W	700 mA	94 x 21 x 67 mm	270586	75
DALI/Push	38 W	700 mA	94 x 21 x 67 mm	270593	95

UPLIGHT Non incluso/Optional



Modello	Potenza	Angolo	Lumen	CCT	Codice	€
□ 35	11 W	120°	1000 lm	3000 K	270258	85
			1300 lm	4000 K	270395	85
□ 45	11 W	120°	1350 lm	3000 K	270258	85
			1700 lm	4000 K	270395	85

KIT PENDANT



Light beam: WIDE



Necessario	Finitura	Codice	€
No	Bianco	254289	50
	Nero	307244	50

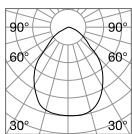

m	lx	Øm
1	2945	1,90
2	736	3,80
3	327	5,60
4	184	7,50
5	116	9,40

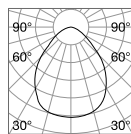
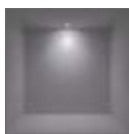

m	lx	Øm
1	1562	1,90
2	390	3,70
3	174	5,60
4	98	7,50
5	62	9,40

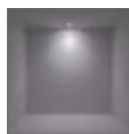

CRI≥80 18W 87° 26501m 3000K

CRI≥80 26W 87° 37001m 3000K



Fly

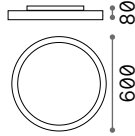

7,200 Kg/0,0694 m³

LED SMD SAMSUNG Driver TRIDONIC ON/OFF incluso

Potenza	Angolo	Lumen	CCT	Finitura	Codice	€
53 W	87°	5600 lm	2700 K	Bianco	341187	610 <small>new</small>
				Nero	341194	610 <small>new</small>
		7200 lm	3000 K	Bianco	270302	610
				Nero	292205	610
		7700 lm	4000 K	Bianco	270319	610
				Nero	306612	610

DIMMABLE DRIVER Non incluso/Optional

	Potenza	Output	Misura	Codice	€
1-10V	60 W	1400 mA	124 x 23 x 82 mm	270340	112
DALI / Push	60 W	1400 mA	125 x 28 x 85 mm	270371	135

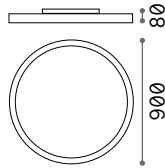

13,000 Kg/0,1441 m³

LED SMD SAMSUNG Driver TRIDONIC ON/OFF incluso

Potenza	Angolo	Lumen	CCT	Finitura	Codice	€
68 W	87°	7350 lm	2700 K	Bianco	341200	1180 <small>new</small>
				Nero	341217	1180 <small>new</small>
		9000 lm	3000 K	Bianco	270326	1180
				Nero	306629	1180
		9550 lm	4000 K	Bianco	270241	1180
				Nero	306636	1180

DIMMABLE DRIVER Non incluso/Optional

	Potenza	Output	Misura	Codice	€
1-10V	68 W	1400 mA	130 x 25 x 75 mm	270357	125
DALI / Push	100 W	1400 mA	140 x 30 x 100 mm	270388	180

UPLIGHT Non incluso/Optional



Modello	Potenza	Angolo	Lumen	CCT	Codice	€
□ 60	17,5 W	120°	2500 lm	3000 K	270401	150
			2650 lm	4000 K	270265	150
□ 90	25 W	120°	3500 lm	3000 K	271002	225
			3650 lm	4000 K	270715	225

KIT PENDANT



Light beam: WIDE



Necessario	Finitura	Codice	€
No	Bianco	254289	50
	Nero	307244	50

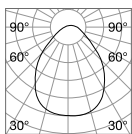

m	lx	Øm
1	2945	1,90
2	736	3,80
3	327	5,60
4	184	7,50
5	116	9,40

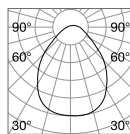
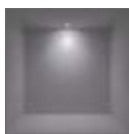

m	lx	Øm
1	3991	1,90
2	998	3,90
3	443	5,80
4	249	7,80
5	160	9,70



CRI≥80 53W 87° 7500lm 3000K

CRI≥80 65W 87° 9400lm 3000K



Fly Slim

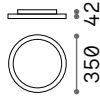

2,700 Kg/0,0105 m³

LED SMD SAMSUNG Driver TRIDONIC ON/OFF incluso

Potenza	Angolo	Lumen	CCT	Finitura	Codice	€
18 W	87°	2150 lm	2700 K	Bianco	341224	295 <small>new</small>
		2800 lm	3000 K	Bianco	306643	295
		3000 lm	4000 K	Bianco	306650	295

DIMMABLE DRIVER Non incluso/Optional

	Potenza	Output	Misura	Codice	€
1-10V/Push	20 W	500 mA	108x22x52 mm	270333	65
DALI	20 W	500 mA	108x22x52 mm	270364	85

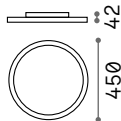

3,750 Kg/0,0170 m³

LED SMD SAMSUNG Driver TRIDONIC ON/OFF incluso

Potenza	Angolo	Lumen	CCT	Finitura	Codice	€
26 W	87°	3000 lm	2700 K	Bianco	341231	390 <small>new</small>
		3900 lm	3000 K	Bianco	292236	390
		4300 lm	4000 K	Bianco	306667	390

DIMMABLE DRIVER Non incluso/Optional

	Potenza	Output	Misura	Codice	€
1-10V/Push	32 W	700 mA	94x21x67 mm	270586	75
DALI/Push	38 W	700 mA	94x21x67 mm	270593	95

UPLIGHT Non incluso/Optional



Modello	Potenza	Angolo	Lumen	CCT	Codice	€
□ 35	11 W	120°	1000 lm	3000 K	270258	85
			1300 lm	4000 K	270395	85
□ 45	12 W	120°	1350 lm	3000 K	270258	85
			1700 lm	4000 K	270395	85

KIT PENDANT



Necessario	Finitura	Codice	€
No	Bianco	254289	50



Light beam: WIDE

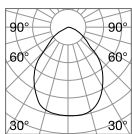

m	lx	Øm
1	1066	1,90
2	267	3,70
3	118	5,60
4	67	7,50
5	43	9,40

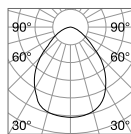
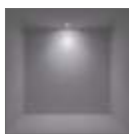

m	lx	Øm
1	1511	1,90
2	378	3,80
3	168	5,70
4	94	7,60
5	60	9,50

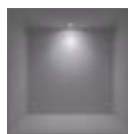

CRI≥80 18W 87° 26501m 3000K

CRI≥80 26W 87° 37001m 3000K



Fly Slim

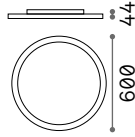

6,500 Kg/0,0694 m³

LED SMD SAMSUNG Driver TRIDONIC ON/OFF incluso

Potenza	Angolo	Lumen	CCT	Finitura	Codice	€
53 W	87°	5600 lm	2700 K	Bianco	341248	575 <small>new</small>
		7200 lm	3000 K	Bianco	292250	575
		7700 lm	4000 K	Bianco	306674	575

DIMMABLE DRIVER Non incluso/Optional

	Potenza	Output	Misura	Codice	€
1-10V	60 W	1400 mA	124 x 23 x 82 mm	270340	112
DALI / Push	60 W	1400 mA	125 x 28 x 85 mm	270371	135

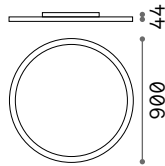

13,000 Kg/0,1448 m³

LED SMD SAMSUNG Driver TRIDONIC ON/OFF incluso

Potenza	Angolo	Lumen	CCT	Finitura	Codice	€
68 W	87°	7350 lm	2700 K	Bianco	341255	1125 <small>new</small>
		9000 lm	3000 K	Bianco	306681	1125
		9550 lm	4000 K	Bianco	306698	1125

DIMMABLE DRIVER Non incluso/Optional

	Potenza	Output	Misura	Codice	€
1-10V	68 W	1400 mA	130 x 25 x 75 mm	270357	125
DALI / Push	100 W	1400 mA	140 x 30 x 100 mm	270388	180

UPLIGHT Non incluso/Optional



Modello	Potenza	Angolo	Lumen	CCT	Codice	€
□ 60	18 W	120°	2500 lm	3000 K	270401	150
			2650 lm	4000 K	270265	150
□ 90	25 W	120°	3500 lm	3000 K	271002	225
			3650 lm	4000 K	270715	225

KIT PENDANT



Necessario	Finitura	Codice	€
No	Bianco	254289	50



Light beam: WIDE

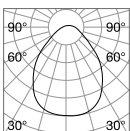

m	lx	Øm
1	3000	1,90
2	750	3,80
3	333	5,70
4	187	7,60
5	120	9,50

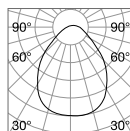
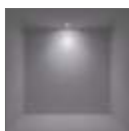

m	lx	Øm
1	3857	1,90
2	964	3,90
3	429	5,80
4	241	7,80
5	154	9,70



CRI≥80 53W 87° 7500lm 3000K

CRI≥80 65W 87° 9400lm 3000K



Halo

Lampada a plafone con base circolare e corpo luce in alluminio verniciato a polveri. Diffusore opale in policarbonato. Disponibile in tre diversi diametri di colore bianco. Sorgente luminosa a LED integrati con binning iniziale ≤ 2-Step MacAdam; disponibile in temperatura di colore 3000 K e 4000 K; CRI ≥ 80; durata utile LED 35.000 h; protezione IP20, classe isolamento I.

Sorgente	LED SMD	Classe	I
Potenza	22W / 32W / 46W	isolamento	
Driver incluso	On/Off	IP	20
Driver disponibili	No	Materiale	Alluminio
CCT	3000 K / 4000 K		
CRI	≥90		
Durata LED	35.000 h		



Luce indiretta inclusa.



LED SMD Driver ON/OFF incluso

Potenza	Angolo	Lumen	CCT	Finitura	Codice	€
22 W	110°	2850 lm	3000 K	Bianco	223186	230
		3100 lm	4000 K	Bianco	223193	230

2,750 Kg/0,0177 m³



LED SMD Driver ON/OFF incluso

Potenza	Angolo	Lumen	CCT	Finitura	Codice	€
32 W	110°	3650 lm	3000 K	Bianco	223209	310
		3800 lm	4000 K	Bianco	223216	310

4,430 Kg/0,0313 m³

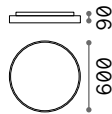

LED SMD Driver ON/OFF incluso

Potenza	Angolo	Lumen	CCT	Finitura	Codice	€
46 W	110°	5350 lm	3000 K	Bianco	223223	545
		5600 lm	4000 K	Bianco	223230	545

6,600 Kg/0,0566 m³

KIT PENDANT



Necessario	Finitura	Codice	€
No	Bianco	223247	50



Ray

Famiglia di lampade a plafone con base circolare, disponibile in tre diametri diversi (300 mm, 400 mm, 600 mm). Corpo luce in finitura bianco RAL 9016 o nero RAL 9005, ottica con diffusore in PMMA microprismatizzato con controllo dell'abbagliamento (UGR < 19, 22). Sorgente luminosa a LED integrati; disponibile in temperatura CRI ≥ 90 ; durata utile LED 50.000 L70B50; protezione IP44, classe isolamento II. La lampada è predisposta con un interruttore integrato per impostare due differenti tonalità nell'emissione di luce (temperatura di colore 3000 K oppure 4000 K). Driver incluso, integrato nel corpo illuminante, disponibile in versione non dimmerabile. Prodotto adatto per ambienti dove richiesta un'illuminazione flessibile, confortevole e uniforme, ad esempio negli UFFICI e negli ambienti interni del TERZIARIO o RESIDENZIALI.

IP44 Grado di protezione IP44.

Sorgente	LED SMD
Potenza	13W / 26W / 43W
Driver incluso	On/Off
Driver disponibili	No
CCT	3000 K / 4000 K
CRI	≥ 90
UGR	<19 / 22
Durata LED	50.000 h
Classe isolamento	II
IP	44
Materiale	Plastica
Garanzia	5 anni



Ray



LED SMD Driver TRIDONIC ON/OFF incluso - UGR <22

Potenza	Angolo	Lumen	CCT	Finitura	Codice	€
13W	77°	2000 - 2100 lm	3000 - 4000 K	Bianco	327570	185
				Nero	327563	185

1,620 Kg/0,0067 m³



LED SMD Driver TRIDONIC ON/OFF incluso - UGR <19

Potenza	Angolo	Lumen	CCT	Finitura	Codice	€
26W	77°	4050 - 4250 lm	3000 - 4000 K	Bianco	318264	270
				Nero	327600	270

2,160 Kg/0,0097 m³

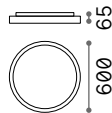

LED SMD Driver TRIDONIC ON/OFF incluso - UGR <19

Potenza	Angolo	Lumen	CCT	Finitura	Codice	€
44W	77°	6850 - 7200 lm	3000 - 4000 K	Bianco	327693	500
				Nero	327686	500

3,240 Kg/0,0251 m³



Light beam: WIDE

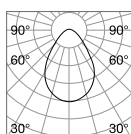

m	lx	Øm
1	760	1,50
2	190	3,00
3	84	4,40
4	48	5,90
5	30	7,40

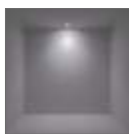

CRI≥90 13W 80° 1900lm 3000K

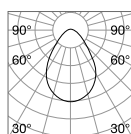

m	lx	Øm
1	1638	1,50
2	410	3,00
3	182	4,40
4	102	5,90
5	66	7,40



CRI≥90 26W 80° 3850lm 3000K

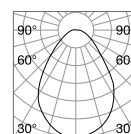

m	lx	Øm
1	2786	1,60
2	697	3,10
3	310	4,70
4	174	6,20
5	111	7,80

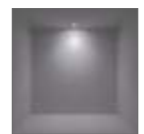

CRI≥90 43W 80° 6450lm 3000K



Universal Round new

Plafoniera diffusiva per installazione a soffitto o parete in interni, adatta per un'illuminazione generale e uniforme. Scocca in acciaio verniciato con finitura bianca, diffusore in materiale plastico. Sorgente luminosa integrata a LED, disponibile in 4 potenze differenti. Durata utile LED 25.000 h; protezione IP20, classe isolamento II.

Sorgente	LED SMD	Durata LED	25.000 h
Potenza	12W / 36W	Classe	II
Driver incluso	On/Off	isolamento	
Driver disponibili	No	IP	20
CCT	2700 K / 3000 K / 4000 K	Materiale	Acciaio
CRI	≥90		

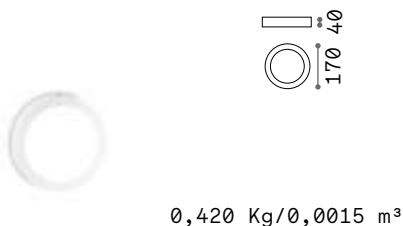

LED SMD Driver ON/OFF incluso

Potenza	Angolo	Lumen	CCT	Finitura	Codice	€
12 W	110°	1100 lm	2700K	Bianco	342566	30 new
		1200 lm	3000 K	Bianco	138596	30
		1300 lm	4000 K	Bianco	321776	30

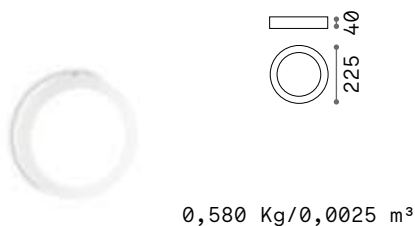

LED SMD Driver ON/OFF incluso

Potenza	Angolo	Lumen	CCT	Finitura	Codice	€
17 W	110°	1750 lm	2700 K	Bianco	342580	35 new
		1800 lm	3000 K	Bianco	138602	35
		1900 lm	4000 K	Bianco	321752	35

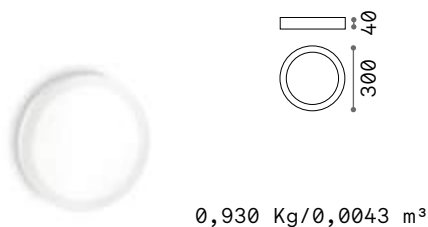

LED SMD Driver ON/OFF incluso

Potenza	Angolo	Lumen	CCT	Finitura	Codice	€
22 W	110°	2250 lm	2700 K	Bianco	342603	50 new
		2400 lm	3000 K	Bianco	138619	50
		2550 lm	4000 K	Bianco	321738	50

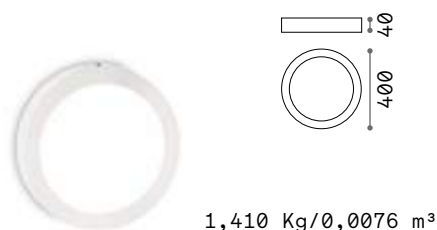

LED SMD Driver ON/OFF incluso

Potenza	Angolo	Lumen	CCT	Finitura	Codice	€
36 W	110°	3400 lm	2700 K	Bianco	342627	85 new
		3850 lm	3000 K	Bianco	240367	85
		4200 lm	4000 K	Bianco	321684	85



Universal Square new

Plafoniera diffusiva per installazione a soffitto o parete in interni, adatta per un'illuminazione generale e uniforme. Scocca in acciaio verniciato con finitura bianca, diffusore in materiale plastico. Sorgente luminosa integrata a LED, disponibile in 4 potenze differenti. Durata utile LED 25.000 h; protezione IP20, classe isolamento II.

Sorgente	LED SMD	Durata LED	25.000 h
Potenza	12W / 36W	Classe	II
Driver incluso	On/Off	isolamento	
Driver disponibili	No	IP	20
CCT	2700 K / 3000 K / 4000 K	Materiale	Acciaio
CRI	≥90		

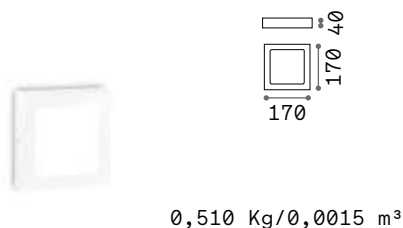

LED SMD Driver ON/OFF incluso

Potenza	Angolo	Lumen	CCT	Finitura	Codice	€
12 W	110°	1100 lm	2700 K	Bianco	342573	30 <small>new</small>
		1200 lm	3000 K	Bianco	138633	30
		1300 lm	4000 K	Bianco	321769	30

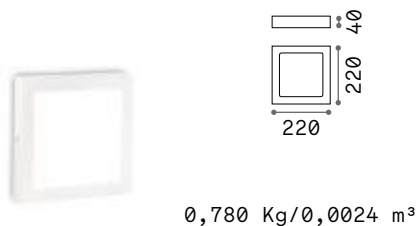

LED SMD Driver ON/OFF incluso

Potenza	Angolo	Lumen	CCT	Finitura	Codice	€
17 W	110°	1750 lm	2700 K	Bianco	342597	35 <small>new</small>
		1800 lm	3000 K	Bianco	138640	35
		1900 lm	4000 K	Bianco	321745	35

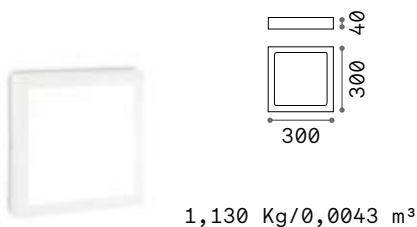

LED SMD Driver ON/OFF incluso

Potenza	Angolo	Lumen	CCT	Finitura	Codice	€
22 W	110°	2250 lm	2700 K	Bianco	342610	50 <small>new</small>
		2400 lm	3000 K	Bianco	138657	50
		2550 lm	4000 K	Bianco	321707	50

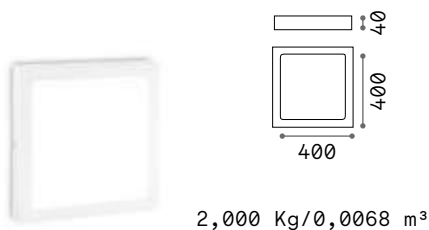

LED SMD Driver ON/OFF incluso

Potenza	Angolo	Lumen	CCT	Finitura	Codice	€
36 W	110°	3400 lm	2700 K	Bianco	342634	85 <small>new</small>
		3850 lm	3000 K	Bianco	240374	85
		4200 lm	4000 K	Bianco	321660	85



Relax

Montatura in metallo rifinito con vernice opaca bianca. Diffusori in policarbonato opale. Doppia emissione luminosa: principale e laterale. Sorgente LED sostituibile. Alimentatore dimmerabile integrato.

LED Sorgente luminosa LED 3000 K, 17.500 h di durata.

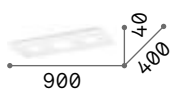
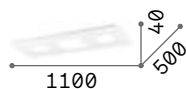

8,190 Kg / 0,0740 m³
LED 84W / 5400 lm

5,760 Kg / 0,0486 m³
LED 65W / 4250 lm

€ 500

€ 450

255941 Bianco

255934 Bianco



Totem

Base in metallo sagomato a laser e verniciato bianco opaco. Sorgenti luminose a LED sostituibili.

LED Lampadine LED GX53 9W 3000 K incluse. Cod. 123936

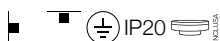
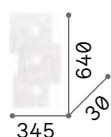
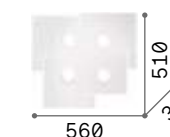
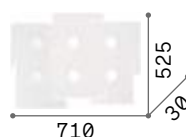

5,320 Kg / 0,0470 m³
GX53 max 6 x 15W

3,890 Kg / 0,0322 m³
GX53 max 4 x 15W

2,960 Kg / 0,0227 m³
GX53 max 3 x 15W

€ 280

€ 240

€ 200

215785 Bianco

215778 Bianco

215761 Bianco

3000 K
910 lm

3000 K
910 lm

3000 K
910 lm

123936 € 5,00

123936 € 5,00

123936 € 5,00





Iride

Base e montatura in metallo verniciato opaco. Diffusore in policarbonato opale ruvido. Colore: bianco.

LED Sorgente luminosa LED 3000 K, 30.000 h di durata.

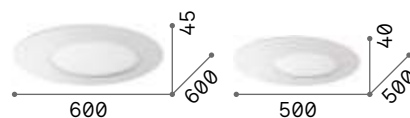

3,800 Kg / 0,0352 m³
LED 22W / 1750 lm

€ 193

328362 Bianco



2,810 Kg / 0,0246 m³
LED 18W / 1300 lm

€ 138

312491 Bianco

Celine

Base in metallo smaltato. Diffusore in vetro trasparente sabbiato. Viti ferma vetro in metallo cromato.

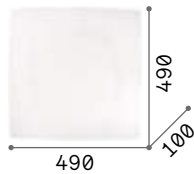

IP20

3,600 Kg / 0,0467 m³
E27 max 4 x 60W

€ 105

044293 Bianco

101286 € 2,00
3000 K
340 lm

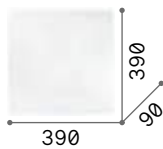

IP20

1,740 Kg / 0,0265 m³
E27 max 3 x 60W

€ 64

044286 Bianco

101286 € 2,00
3000 K
340 lm

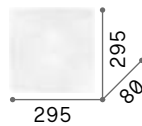

IP20

1,120 Kg / 0,0149 m³
E27 max 2 x 60W

€ 49

044279 Bianco

101286 € 2,00
3000 K
340 lm

Ocean

Diffusore composto da due lastre di vetro: sotto con bordo a specchio e smerigliato al centro, sopra con decorazione serigrafata e applicazioni di bottoni in vetro.

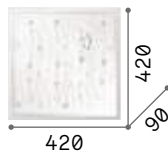

IP20

2,930 Kg / 0,0281 m³
E27 max 3 x 60W

€ 110

081441 Trasparen.
091013 Color

101286 € 2,00
3000 K
340 lm

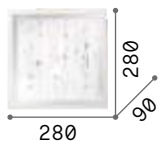

IP20

1,930 Kg / 0,0160 m³
E27 max 2 x 60W

€ 75

081434 Trasparen.
091006 Color

101286 € 2,00
3000 K
340 lm



091013



0801441



Squish new

Base in metallo. Doppio diffusore in policarbonato: quello interno opale satinato, quello esterno trasparente.

LED Sorgente luminosa LED 3000 K, 25.000 h di durata.

■ ■ IP20	■ ■ IP20	■ ■ IP20
2,100 Kg / 0,0934 m³ LED 30W / 3350 lm	2,190 Kg / 0,0429 m³ LED 18W / 1700 lm	0,760 Kg / 0,0228 m³ LED 10W / 950 lm
€ 208	€ 118	€ 88
332420 Trasparen.new	332413 Trasparen.new	332406 Trasparen.new

Gemini new

Rosone e paralume in metallo verniciato a polveri o placcato. Diffusore in policarbonato opale. Cavo in pvc trasparente. Disponibile nelle finiture bianco, nero o ottone spazzolato. Modelli con diametro 810 mm e 610 mm disponibili anche in versione dimmerabile DALI/Push.

Sorgente	LED SMD	Durata LED	50.000 h
Potenza	24W / 42W	Classe	II
Driver incluso	On/Off / DALI/Push	isolamento	
Driver disponibili	No	IP	20
Angolo	130°	Materiale	Alluminio
CCT	2700 K / 3000 K		
CRI	≥90		

LED SMD Driver incluso

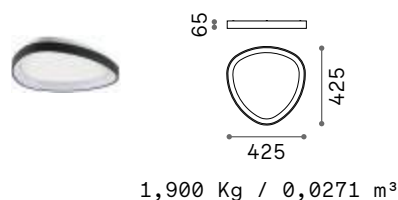

Dimensioni	Potenza	Driver	Lumen	CCT	Finitura	Codice	€
425x425	24 W	On-Off	2300 lm	2700 K	Bianco	341439	220 <small>new</small>
					Nero	341446	220 <small>new</small>
					Ottone	341453	220 <small>new</small>
			2900 lm	3000 K	Bianco	328010	220
					Nero	328027	220
					Ottone	328034	220

LED SMD Driver incluso

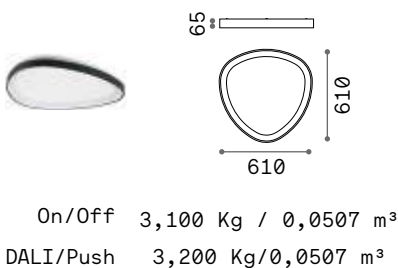

Dimensioni	Potenza	Driver	Lumen	CCT	Finitura	Codice	€
610x610	30 W	On-Off	3300 lm	2700 K	Bianco	341460	300 <small>new</small>
					Nero	341477	300 <small>new</small>
					Ottone	341484	300 <small>new</small>
			3600 lm	3000 K	Bianco	328041	300
					Nero	328058	300
					Ottone	328065	300
	28 W	DALI/Push	3100 lm	3000 K	Bianco	328942	380
					Nero	328959	380
					Ottone	328966	380

LED SMD Driver incluso

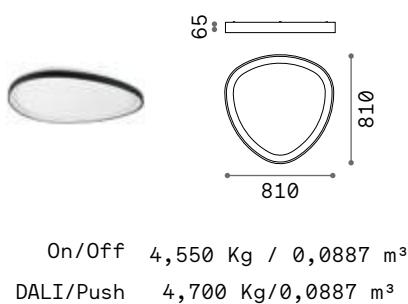

Dimensioni	Potenza	Driver	Lumen	CCT	Finitura	Codice	€
810x810	42 W	On-Off	4150 lm	2700 K	Bianco	341491	390 <small>new</small>
					Nero	341507	390 <small>new</small>
					Ottone	341514	390 <small>new</small>
			4450 lm	3000 K	Bianco	328072	390
					Nero	328089	390
					Ottone	328096	390
	42 W	DALI/Push	4150 lm	3000 K	Bianco	328973	480
					Nero	328980	480
					Ottone	329260	480



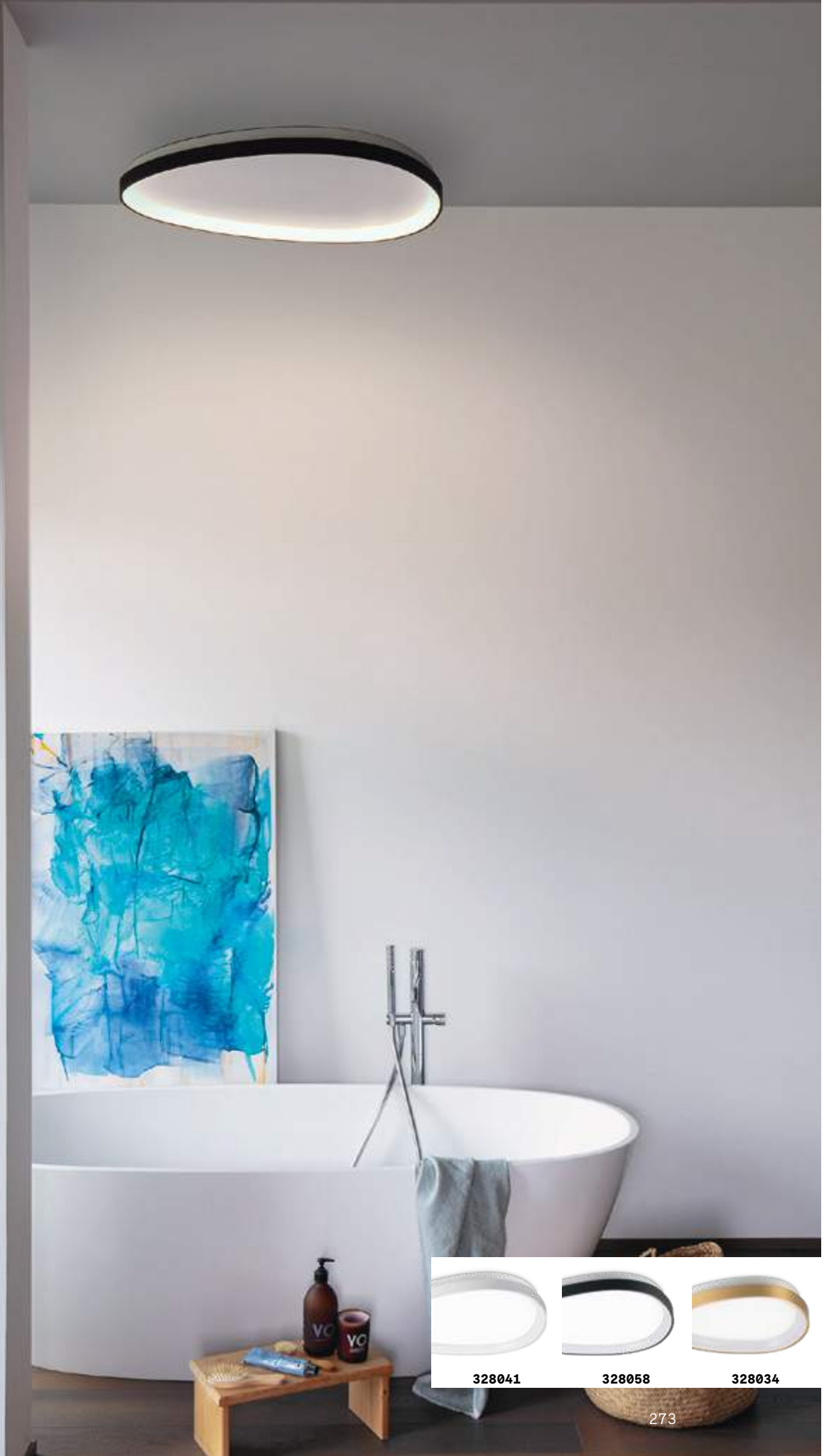

328041

328058

328034



Gingle

Base e corpo luce in metallo verniciato a polveri. Sorgente luminosa a led integrati con emissione di luce riflessa.



Sorgente luminosa LED 3000 K, 30.000 h di durata.

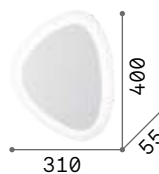

1,540 Kg / 0,0233 m³
LED 35W / 2900 lm

€ 350

196220 Bianco

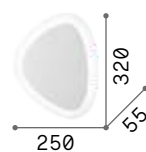

1,000 Kg / 0,0139 m³
LED 26W / 2200 lm

€ 250

196206 Bianco

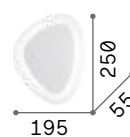

0,730 Kg / 0,0153 m³
LED 19W / 1650 lm













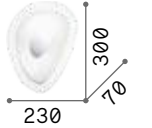

€ 180

196190 Bianco



Geko

Montatura in metallo smaltato bianco. Diffusore con vetro trasparente serigrafato in bianco. Elemento centrale fissa vetro in metallo cromato.

		
400	305	230
560	405	300
65	65	70
   IP20	   IP20	   IP20
3,820 Kg / 0,0385 m³	2,000 Kg / 0,0203 m³	1,200 Kg / 0,0130 m³
E27 max 4 x 60W	E27 max 3 x 60W	E27 max 2 x 60W
€ 180	€ 120	€ 85
116112 Bianco	018508 Bianco	010861 Bianco
 3000 K	 3000 K	 3000 K
340 lm	340 lm	340 lm
101286 € 2,00	101286 € 2,00	101286 € 2,00

Glory

Montatura in metallo con finitura nickel satinato. Diffusore in vetro bianco soffiato e acidato.

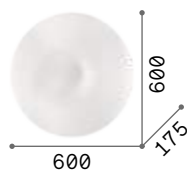

IP20

4,810 Kg / 0,1789 m³
E27 max 5 x 60W

€ 350

019765 Bianco

3000 K
340 lm
101286 € 2,00

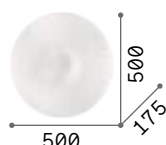

IP20

3,410 Kg / 0,0744 m³
E27 max 3 x 60W

€ 220

019758 Bianco

3000 K
340 lm
101286 € 2,00

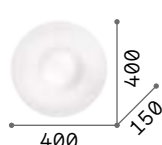

IP20

2,100 Kg / 0,0700 m³
E27 max 2 x 60W

€ 195

101132 Bianco

3000 K
340 lm
101286 € 2,00



P. 153

Level

Base in metallo verniciato a polveri. Diffusore in vetro soffiato bianco acidato con sistema di fissaggio senza viti. Sorgente a led integrato facilmente sostituibile.

LED Sorgente luminosa LED 3000 K, 17.500 h di durata.



IP20

5,200 Kg / 0,0908 m³
LED 37,5W / 3100 lm

€ 320

261188 Bianco

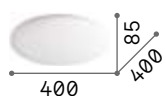

IP20

2,100 Kg / 0,0368 m³
LED 22,5W / 2000 lm

€ 190

261164 Bianco





Smarties

Montatura in metallo verniciato bianco. Diffusore in vetro bianco soffiato.

IP20	IP20	IP20	IP20
4,690 Kg / 0,1480 m ³ E27 max 3 x 42W	3,070 Kg / 0,1009 m ³ E27 max 3 x 42W	2,810 Kg / 0,0599 m ³ E27 max 2 x 42W	1,440 Kg / 0,0454 m ³ E27 max 1 x 42W
€ 280	€ 195	€ 170	€ 115
032023 Bianco	032030 Bianco	032047 Bianco	009223 Bianco
3000 K 340 lm	3000 K 340 lm	3000 K 340 lm	3000 K 340 lm
101286 € 2,00	101286 € 2,00	101286 € 2,00	101286 € 2,00



P. 154



P. 385



P. 469



Arizona

Montatura in metallo rifinito in ottone satinato. Diffusore in vetro bianco soffiato, acidato e con rigature decorative in rilievo.



LED Lampadine LED GX53 9W 3000 K incluse. Cod. **123936**

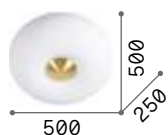

IP20 INCLUSA

7,680 Kg / 0,1299 m³
GX53 max 5 x 9W

€ 505

214511 Bianco

3000 K
910 lm

123936 € 5,00

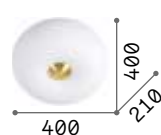

IP20 INCLUSA

3,050 Kg / 0,0744 m³
GX53 max 3 x 9W

€ 330

214504 Bianco

3000 K
910 lm

123936 € 5,00

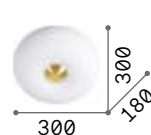

IP20 INCLUSA

2,960 Kg / 0,0452 m³
GX53 max 2 x 9W

€ 225

214498 Bianco

3000 K
910 lm

123936 € 5,00



P. 156



Atrium

Montatura in metallo verniciato bianco opaco. Diffusore in vetro bianco acidato con sistema di fissaggio ad incastro.

LED Sorgente luminosa LED 3000 K, 20.000 h di durata.

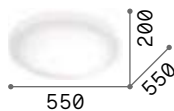

■ ■ □ IP20

4,8 Kg / 0,1113 m³
LED 26W / 2600 lm

€ 220

265841 Bianco

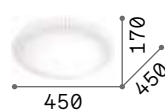

■ ■ □ IP20

3,700 Kg / 0,0675 m³
LED 22,5W / 2250 lm

€ 160

265827 Bianco

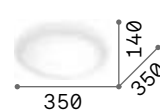

■ ■ □ IP20

2,300 Kg / 0,0425 m³
LED 15W / 1500 lm

€ 115

265803 Bianco



Candy

Montatura in metallo con finitura nickel satinato. Diffusore in vetro bianco soffiato e acidato.



2,500 Kg / 0,0799 m³
E27 max 1x 42W

€ 197

086781 Bianco

3000 K
900 lm

123899 € 3,50



P. 158



P. 469



Cotton

Base in metallo rifinito con vernice a polveri di colore bianco. Diffusore in vetro soffiato bianco acidato con fissaggio a vite.



Lampadine LED G9 3W 3000 K incluse nel modello **297750**. Cod. **209043**

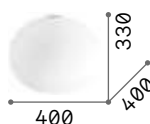

■ □ IP20

2,400 Kg / 0,0810 m³
E27 max 1x42W

€ 180

327891 Bianco

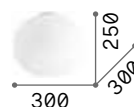

■ □ IP20

0,810 Kg / 0,0369 m³
E27 max 1x42W

€ 125

297743 Bianco



■ □ IP20 

0,200 Kg / 0,0060 m³
G9 max 1x4W

€ 50

297750 Bianco



P. 159

 **3000 K**
900 lm
123899 € 3,50

 **3000 K**
900 lm
123899 € 3,50

 **3000 K**
510 lm
305486 € 6,00

Mapa

Base e sistema di fissaggio in metallo bianco. Diffusore a sfera in vetro bianco soffiato e acidato.



■ □ IP20

2,590 Kg / 0,1290 m³

E27 max 1x 42W

€ 188

059839 ■ Bianco



3000 K
910 lm

119571 € 3,50

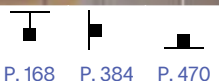

P. 168 P. 384 P. 470

Carta

Montatura in metallo verniciato bianco opaco. Diffusore in policarbonato con rivestimento ad effetto carta.



■ □ IP20

1,700 Kg / 0,0813 m³

E27 max 1x 25W

€ 225

317120 ■ Bianco



3000 K
910 lm

119571 € 3,50



■ □ IP20

1,150 Kg / 0,0370 m³

E27 max 1x 25W

€ 110

317113 ■ Bianco



3000 K
430 lm

101279 € 2,00



P. 170 P. 385 P. 468 P. 519



Topico **new**

Montatura in metallo verniciato opaco. Diffusore con doppio vetro: interno bianco acidato, esterno trasparente con sfumatura fumè sulla parte superiore. Colore: nero.

LED Sorgente luminosa LED 3000 K, 30.000 h di durata.



■ □ IP20

2,250 Kg / 0,0843 m³
LED 19W / 1850 lm

€ 160

333014 ■ Fumè

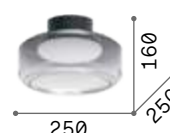

■ □ IP20

1,760 Kg / 0,0327 m³
LED 12W / 1450 lm

€ 100

new 333007 ■ Fumè **new**



Ovalino

Montatura in metallo smaltato.
Diffusore con elementi in lastra di vetro curvata e acidata.

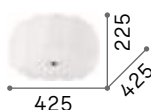
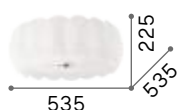

IP20

IP20

7,700 Kg / 0,1448 m³
E27 max 8 x 60W

5,100 Kg / 0,1202 m³
E27 max 5 x 60W

€ 320

€ 250

094014 Bianco

093963 Bianco

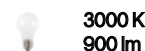

123899 € 3,50

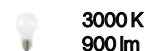

123899 € 3,50



P. 157 P. 382



Cloud

Montatura ed elementi decorativi in metallo rifinito con vernice opaca.
Diffusori in acrilico opale. Emissione luce indiretta. Colore: bianco.

LED Sorgente luminosa LED 3000 K,
17.500 h di durata.

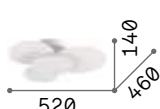

IP20

IP20

4,700 Kg / 0,0792 m³
LED 46W / 3350 lm

3,200 Kg / 0,0647 m³
LED 33W / 2450 lm

€ 320

€ 230

285207 Bianco

263519 Bianco





Corolla

Montatura in metallo verniciato bianco opaco. Diffusore in policarbonato opale satinato.

LED Sorgente luminosa LED 3000 K, 50.000 h di durata.



■ □ IP20

2,450 Kg / 0,0274 m³
LED 24W / 2750 lm

€ 180

297149 Bianco

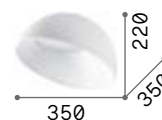

■ □ IP20

2,450 Kg / 0,0304 m³
LED 24W / 2750 lm

€ 180

297101 Bianco



Ziggy

Corpo luce in metallo verniciato a polveri. Pareti interne diffondenti in policarbonato opale satinato.

LED Sorgente luminosa LED 3000 K, 50.000 h di durata.



6,660 Kg / 0,0953 m³
LED 62W / 7350 lm

€ 430

317908 ■ Bianco
321615 ■ Nero

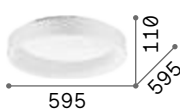

4,000 Kg / 0,0553 m³
LED 43W / 4400 lm

€ 245

293790 ■ Bianco
307213 ■ Nero

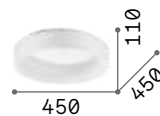

2,500 Kg / 0,0324 m³
LED 30W / 3150 lm

€ 200

293783 ■ Bianco
307206 ■ Nero

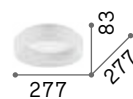

1,350 Kg / 0,0096 m³
LED 21W / 2750 lm

€ 160

293776 ■ Bianco
293769 ■ Nero



Planet

Base e disco riflettente centrale in metallo verniciato opaco. Diffusore in policarbonato opale satinato.
Finiture: bianco, nero.

LED Sorgente luminosa LED 3000 K,
30.000 h di durata.

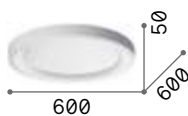

■ □ IP20

2,950 Kg / 0,0365 m³
LED 29W / 2650 lm

€ 165

312378 ■ Bianco
312361 ■ Nero

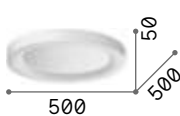

■ □ IP20

2,150 Kg / 0,0257 m³
LED 25W / 2250 lm

€ 132

312354 ■ Bianco
328157 ■ Nero

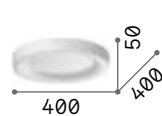

■ □ IP20

1,350 Kg / 0,0168 m³
LED 20W / 1850 lm

€ 110

312347 ■ Bianco
312330 ■ Nero

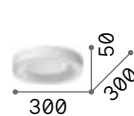

■ □ IP20

0,820 Kg / 0,0097 m³
LED 15W / 1350 lm

€ 88

312323 ■ Bianco
328140 ■ Nero



P. 130 P. 508

Mix Up

Montatura e paralumi intercambiabili in metallo verniciato a polveri. Finiture: bianco oppure nero.

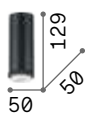

IP20

0,270 Kg / 0,005 m³
E27 max 1x60W

€ 35

292847 ■ Bianco
292830 ■ Nero

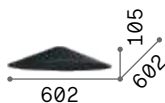

2,000 Kg / 0,0676 m³

€ 85

288437 ■ Bianco
288420 ■ Nero



1,100 Kg / 0,0446 m³

€ 55

307404 ■ Bianco
288475 ■ Nero

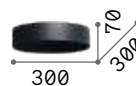

0,800 Kg / 0,0147 m³

€ 40

307411 ■ Bianco
288444 ■ Nero

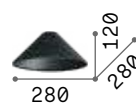

0,500 Kg / 0,0174 m³

€ 35

307428 ■ Bianco
288451 ■ Nero



3000 K
900 lm

123899

€ 3,50



260457

304625

270012

260464

345895

Set Up new

Montature in metallo verniciato a polveri. Paralumi in pvc ignifugo rivestito di tessuto. Colori paralumi: beige, tortora, bianco, nero o legno.



2,000 Kg / 0,1384 m³

€ 172

- 345918 Bianco
- 345932 Tortora
- 345925 Nero
- 339269 Beige
- 339276 Legno

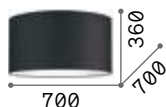

1,260 Kg / 0,0674 m³

€ 138

- new 260471 Bianco
- new 304632 Tortora
- new 270029 Nero
- new 260488 Beige
- new 345901 Legno

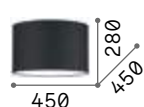

0,770 Kg / 0,0221 m³

€ 92

- 260457 Bianco
- 304625 Tortora
- 270012 Nero
- 260464 Beige
- new 345895 Legno

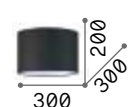

0,460 Kg / 0,0228 m³

€ 63

- 260433 Bianco
- 304618 Tortora
- 270005 Nero
- 260440 Beige
- new 345888 Legno new



■ □ IP20

1,000 Kg / 0,0047 m³
E27 max 4 x 42W

€ 80

- 320373 Bianco



■ □ IP20

1,000 Kg / 0,0047 m³
E27 max 4 x 42W

€ 80

- new 320373 Bianco

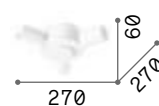

■ □ IP20

0,850 Kg / 0,0041 m³
E27 max 3x 42W

€ 58

- new 348278 Bianco

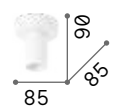

■ □ IP20

0,300 Kg / 0,0010 m³
E27 max 1x 42W

€ 35

- new 277288 Bianco

3000 K
900 lm
123899 € 3,50

3000 K
900 lm
123899 € 3,50

3000 K
900 lm
123899 € 3,50

3000 K
900 lm
123899 € 3,50



0,500 Kg / 0,0423 m³

€ 80

- 339252 Trasparen.new



0,700 Kg / 0,0259 m³

€ 58

- 270050 Trasparen.

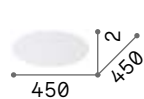

0,280 Kg / 0,0108 m³

€ 35

- 270043 Trasparen.

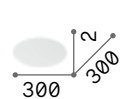

0,100 Kg / 0,0061 m³

€ 17

- 346847 Trasparen.new



339290

346045

346038

346014

346021

Set Up Slim new

Montature in metallo verniciato a polveri. Paralumi in pvc ignifugo rivestito di tessuto. Colori paralumi: beige, tortora, bianco, nero o legno.



1,200 Kg / 0,1903 m³

€ 138

346069 Bianco new
339283 Tortora new
346083 Nero new
346052 Beige new
346076 Legno new



0,750 Kg / 0,1172 m³

€ 115

339290 Bianco new
346045 Tortora new
346038 Nero new
346014 Beige new
346021 Legno new



0,440 Kg / 0,0415 m³

€ 80

345987 Bianco new
346007 Tortora new
345994 Nero new
345970 Beige new
339306 Legno new

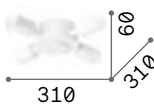

1,000 Kg / 0,0047 m³
E27 max 4 x 42W

€ 80

320373 Bianco new

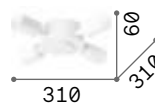

1,000 Kg / 0,0047 m³
E27 max 4 x 42W

€ 80

320373 Bianco new

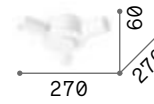

0,850 Kg / 0,0041 m³
E27 max 3x 42W

€ 58

348278 Bianco new

3000 K
900 lm
123899 € 3,50

3000 K
900 lm
123899 € 3,50

3000 K
900 lm
123899 € 3,50

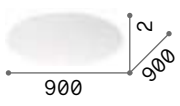

0,500 Kg / 0,0423 m³

€ 80

339252 Trasparen.new



0,700 Kg / 0,0259 m³

€ 58

270050 Trasparen.

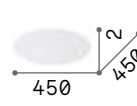

0,280 Kg / 0,0108 m³

€ 35

270043 Trasparen.





Set Up Ultra Slim new

Montature in metallo verniciato a polveri. Paralumi in pvc ignifugo rivestito di tessuto. Colori paralumi: beige, tortora, bianco, nero o legno.



0,800 Kg / 0,1124 m³

€ 126

346182 Bianco new
 346205 Tortora new
 339313 Nero new
 346175 Beige new
 346199 Legno new

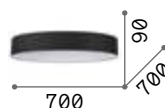

0,600 Kg / 0,0613 m³

€ 103

346144 Bianco new
 346168 Tortora new
 346151 Nero new
 346137 Beige new
 339320 Legno new

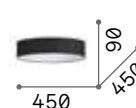

0,500 Kg / 0,0265 m³

€ 69

339337 Bianco new
 346120 Tortora new
 346113 Nero new
 346090 Beige new
 346106 Legno new

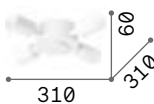

■ IP20

1,000 Kg / 0,0047 m³
 E27 max 4 x 42W

€ 80

320373 Bianco new

3000 K
 900 lm
 123899 € 3,50

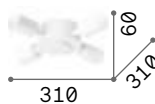

■ IP20

1,000 Kg / 0,0047 m³
 E27 max 4 x 42W

€ 80

320373 Bianco new

3000 K
 900 lm
 123899 € 3,50

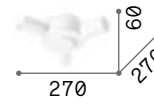

■ IP20

0,850 Kg / 0,0041 m³
 E27 max 3x 42W

€ 58

348278 Bianco new

3000 K
 900 lm
 123899 € 3,50

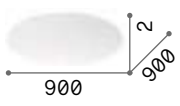

0,500 Kg / 0,0423 m³

€ 80

339252 Trasparen new

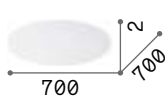

0,700 Kg / 0,0259 m³

€ 58

270050 Trasparen

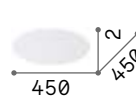

0,280 Kg / 0,0108 m³

€ 35

270043 Trasparen



Simply

Diffusore in vetro trasparente sabbato. Ganci ferma vetro in metallo cromato con sistema di bloccaggio a molla.

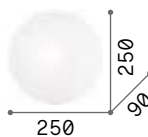
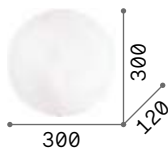
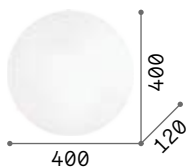
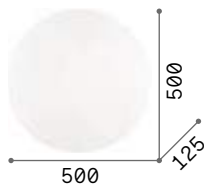

3,190 Kg / 0,0511 m³
E27 max 4 x 60W

€ 85

007991 Bianco

3000 K
340 lm

101286 € 2,00

1,670 Kg / 0,0284 m³
E27 max 3 x 60W

€ 54

007984 Bianco

3000 K
340 lm

101286 € 2,00

1,010 Kg / 0,0107 m³
E27 max 2 x 60W

€ 37

007977 Bianco

3000 K
340 lm

101286 € 2,00

0,670 Kg / 0,0060 m³
E27 max 1 x 60W

€ 28

007960 Bianco

3000 K
340 lm

101286 € 2,00

Lana

Diffusore in vetro trasparente con decorazioni serigrafate all'interno e sabbato all'esterno. Ganci ferma vetro in metallo cromato.

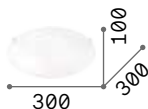
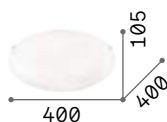

1,500 Kg / 0,0279 m³
E27 max 3 x 60W

€ 68

068145 Bianco

3000 K
340 lm

101286 € 2,00

0,800 Kg / 0,0168 m³
E27 max 2 x 60W

€ 46

068138 Bianco

3000 K
340 lm

101286 € 2,00



P. 153





Shell

Diffusore di vetro trasparente lavorato in piastra e decorato all'interno con graniglia. Blocca vetro con dettaglio in metallo. Disponibile trasparente con dettaglio cromato o ambra con dettaglio ottonato.



008622



140193

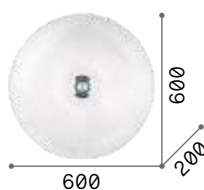

8,850 Kg / 0,0943 m³
E27 max 6 x 60W

€ 320

008622 Trasparen.
140193 Ambra

3000 K
430 lm

101279 € 2,00

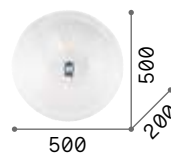

6,150 Kg / 0,0647 m³
E27 max 4 x 60W

€ 240

008615 Trasparen.
140186 Ambra

3000 K
430 lm

101279 € 2,00

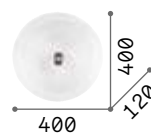

3,940 Kg / 0,0381 m³
E27 max 3 x 60W

€ 160

008608 Trasparen.
140179 Ambra

3000 K
430 lm

101279 € 2,00



Look

Base di fissaggio in alluminio tornito. Diffusore cilindrico in metallo verniciato a polveri bianco o nero oppure in ottone satinato.

LED Lampadine LED GU10 7W 3000 K incluse. Cod. **123943**

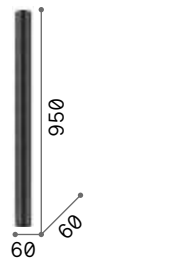

3,070 Kg / 0,0053 m³
GU10 max 1x28W

€ 86

259260 ■ Bianco
259277 ■ Nero

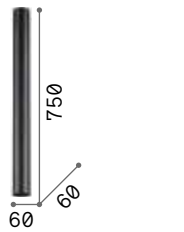

1,380 Kg / 0,0043 m³
GU10 max 1x28W

€ 60

233352 ■ Bianco
233321 ■ Nero

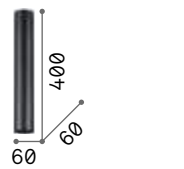

0,740 Kg / 0,0025 m³
GU10 max 1x28W

€ 42

233215 ■ Bianco
233192 ■ Nero

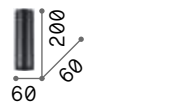

0,400 Kg / 0,0013 m³
GU10 max 1x28W

€ 32

233079 ■ Bianco
233062 ■ Nero
285214 ■ Ottone



P. 078 P. 381 P. 506 P. 698

3000 K
540 lm

123943 € 3,50

3000 K
540 lm

123943 € 3,50

3000 K
540 lm

123943 € 3,50

3000 K
540 lm

123943 € 3,50



Sky

Corpo luce diffusore in metallo verniciato a polveri con finitura bianca o nera. Sistema di fissaggio senza viti a vista.

LED Lampadine LED GU10 7W 3000 K incluse. Cod. **123943**

1,940 Kg / 0,0047 m³ GU10 max 1x28W	1,090 Kg / 0,0027 m³ GU10 max 1x28W	0,600 Kg / 0,0016 m³ GU10 max 1x28W
€ 70	€ 65	€ 47
234007 ■ Bianco 233970 ■ Nero	233833 ■ Bianco 233826 ■ Nero	233772 ■ Bianco 233765 ■ Nero
3000 K 540 lm	3000 K 540 lm	3000 K 540 lm
123943 € 3,50	123943 € 3,50	123943 € 3,50

Nitro Round new

Corpo luce in alluminio verniciato bianco o nero opachi. Interno rifinito con mascherina in plastica. Sorgente luminosa a led integrato con lente.

Sorgente	LED DOB / COB	Classe	I - II
Potenza	4W / 25W	isolamento	
Driver incluso	On/Off	IP	20
Driver disponibili	No	Materiale	Alluminio
CCT	2700 K / 3000 K		
CRI	≥90		
Durata LED	50.000 h		



0,600 Kg/0,0004 m³

LED DOB

Potenza	Angolo	Lumen	CCT	Finitura	Codice	€
4 W	40°	290 lm	2700K	Bianco	342788	45 <small>new</small>
				Nero	342795	45 <small>new</small>
		320 lm	3000K	Bianco	299419	45
				Nero	299402	45



0,390 Kg/0,0013 m³

LED COB BRIDGELUX

Potenza	Angolo	Lumen	CCT	Finitura	Codice	€
10 W	28°	900 lm	2700 K	Bianco	341781	65 <small>new</small>
				Nero	341798	65 <small>new</small>
		1000 lm	3000 K	Bianco	205991	65
				Nero	206004	65

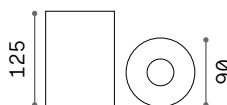

0,910 Kg/0,0030 m³

LED COB BRIDGELUX

Potenza	Angolo	Lumen	CCT	Finitura	Codice	€
15 W	36°	1400 lm	3000 K	Bianco	205977	90
				Nero	205984	90

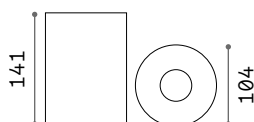

0,860 Kg/0,0018 m³

LED COB BRIDGELUX

Potenza	Angolo	Lumen	CCT	Finitura	Codice	€
25 W	33°	2350 lm	3000 K	Bianco	319568	115
				Nero	322711	115



Nitro Square

Corpo luce in alluminio verniciato bianco o nero opachi. Interno rifinito con mascherina in plastica. Sorgente luminosa a led integrato con lente.

Sorgente	LED DOB / COB	Classe	I - II
Potenza	5W / 25W	isolamento	
Driver incluso	On/Off	IP	20
Driver disponibili	No	Materiale	Alluminio
CCT	3000 K / 4000 K		
CRI	≥90		
Durata LED	50.000 h		



0,100 Kg/0,0004 m³

LED DOB

Potenza	Angolo	Lumen	CCT	Finitura	Codice	€
5W	40°	370 lm	3000K	Bianco	319797	67
				Nero	319803	67



0,230 Kg/0,0005 m³

LED COB BRIDGELUX

Potenza	Angolo	Lumen	CCT	Finitura	Codice	€
10W	28°	1000 lm	3000 K	Bianco	206035	65
				Nero	206042	65

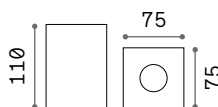

0,400 Kg/0,0013 m³

LED COB BRIDGELUX

Potenza	Angolo	Lumen	CCT	Finitura	Codice	€
15W	36°	1400 lm	3000 K	Bianco	206011	90
				Nero	206028	90

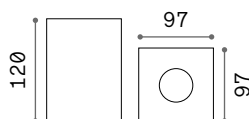

0,700 Kg/0,0016 m³

LED COB BRIDGELUX

Potenza	Angolo	Lumen	CCT	Finitura	Codice	€
25W	33°	2350 lm	3000 K	Bianco	319575	115
				Nero	319582	115



319803



Kubiko

Corpo luce in alluminio verniciato a polveri. Diffusore in policarbonato opale lucido. Sistema di fissaggio magnetico. Finiture: bianco, nero.

LED

Sorgente luminosa LED 3000 K,
30.000 h di durata.

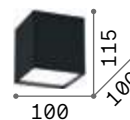

■  IP20

0,660 Kg / 0,0020 m³
LED 10W / 1100 lm

€ 80

303321 ■ Bianco
303314 ■ Nero



303321



303314



Mood

Corpo luce in metallo disponibile con sezione quadra o tonda. Nero all'interno e bianco o nero all'esterno. Diffusore interno orientabile.

LED Lampadine GU10 7W e GU10 10W 3000 K incluse.



140841

243924

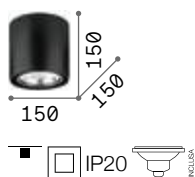

1,210 Kg / 0,0061 m³
GU10 max 1x 50W

€ 97

140872 **Bianco**
243450 **Nero**

3000 K
750 lm

189031 € 15,00



0,400 Kg / 0,0022 m³
GU10 max 1x 28W

€ 64

140841 **Bianco**
243924 **Nero**

3000 K
540 lm

123943 € 3,50

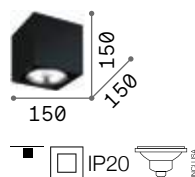

1,420 Kg / 0,0068 m³
GU10 max 1x 50W

€ 97

140933 **Bianco**
243931 **Nero**

3000 K
750 lm

189031 € 15,00

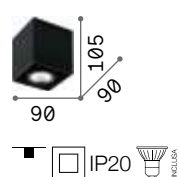

0,460 Kg / 0,0023 m³
GU10 max 1x 28W

€ 64

140902 **Bianco**
243948 **Nero**

3000 K
540 lm

123943 € 3,50



Spike

Corpo luce in alluminio verniciato a polveri o placcato. Disponibile con sorgente GX53 o a led integrato con diffusore in policarbonato opale satinato. Colori: bianco, nero o ottone satinato.

Lampadine LED GX53 9W 3000 K incluse. Cod. **123936**.

LED

Sorgente luminosa LED 3000 K, 25.000 h di durata. Cod **345468, 336008, 345475**



285238



310893



328799



317496

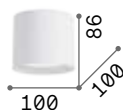

0,340 Kg / 0,0012 m³
LED 10W / 1100 lm

€ 40

345468 Bianco *new*
336008 Nero *new*
345475 Ottone *new*

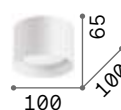

0,240 Kg / 0,0017 m³
GX53 max 1x15W

€ 80

277417 Bianco
310886 Cromo
278704 Nero
285238 Ottone
310893 Rame

3000 K
910 lm

123936 € 5,00

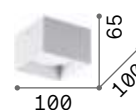

0,220 Kg / 0,0014 m³
GX53 max 1x15W

€ 85

317489 Bianco
328799 Cromo
317496 Nero
317502 Ottone
328812 Rame

3000 K
910 lm

123936 € 5,00



Oak

Corpo luce in gesso o cemento.
Elemento portalampada centrale orientabile in metallo verniciato.



Articolo adatto alla pittura e verniciatura.

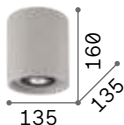

■ □ IP20

1,730 Kg / 0,0082 m³
GU10 max 1x35W

€ 76

150420 ■ Bianco
150437 ■ Cemento



3000 K
410 lm



108292 € 3,00 [P. 082](#)



Tower

Base di fissaggio in materiale plastico con sistema a baionetta.
Corpo luce interamente in gesso.
Monta lampadine GU10 sostituibili.



Articolo adatto alla pittura e verniciatura.

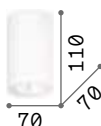

■ □ IP20

0,430 Kg / 0,0023 m³
GU10 max 1x35W

€ 39

155869 ■ Bianco



3000 K
410 lm

108292 € 3,00



■ □ IP20

0,620 Kg / 0,0023 m³
GU10 max 1x35W

€ 39

155791 ■ Bianco



3000 K
410 lm

108292 € 3,00





Lika

Famiglia di moduli LED rettangolari in alluminio pressofuso, verniciato nero o bianco con riflettore in policarbonato. Moduli disponibili con cinque lenti. Appositamente disegnato per evitare abbagliamenti (UGR<16), trova la sua migliore collocazione all'interno di UFFICI e spazi COMMERCIALI.

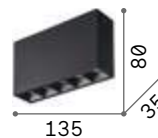

IP20

0,370 Kg / 0,0011 m³
LED 12,5W / 1200 lm

€ 90

248530 ■ Bianco
244884 ■ Nero

LED Sorgente luminosa LED 3000 K,
50.000 h di durata.



P. 784



Dynamite

Montatura in metallo rifinito con vernice a polveri o placcato e spazzolato. Diffusori orientabili.



Lampadine LED GU10 7W 3000 K incluse. Cod. **123943**



0,430 Kg / 0,0037 m³
GU10 max 1x28W

€ 98

231495 ■ Bianco
231471 ■ Nero
244662 ■ Ottone

3000 K
540 lm

123943 € 3,50



P. 096

Play

Base, snodo e corpo luce orientabile in alluminio pressofuso verniciato a polveri. Diffusore in acrilico trasparente zigrinato. Disponibile nelle finiture nero oppure bianco con cover posteriore e ghiera frontale interni neri.

LED Sorgente luminosa LED 3000 K, 30.000 h di durata.



IP20

0,240 Kg / 0,0010 m³
LED 7W / 520 lm

€ 70

258287 Bianco
268101 Nero



P. 778



Toby

Montatura in alluminio pressofuso verniciato a polveri. Diffusori orientabili in rotazione e inclinazione. Colori: bianco o nero.

LED Lampadine LED GU10 7W 3000 K incluse. Cod. 123943

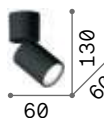

IP20

0,220 Kg / 0,0008 m³
GU10 max 1x 35W

€ 60

271538 Bianco
271545 Nero

3000 K
540 lm

123943 € 3,50





Petit

Corpo luce in metallo placcato o verniciato opaco. Sistema di fissaggio senza viti a vista. Disponibile con finitura bianca, ottone e nero.

LED Lampadine LED E27 8W Globo D95 3000 K incluse nei modelli: **232966**, **232980** e **233031**. Cod. **101330**

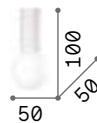

0,790 Kg / 0,0071 m³
E27 max 1x 42W

€ 30

232966 Bianco
232980 Nero
233031 Ottone

3000 K
950 lm

101330 € 4,50



232966



232980



233031



Winery

Corpo luce con portalampane incorporato interamente in ceramica con finitura in smalto lucido bianco o nero.

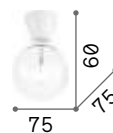

IP20

0,290 Kg / 0,0004 m³
E27 max 1x 60W

€ 27

155227 ■ Bianco
155142 ■ Nero

101323 3000 K
1050 lm € 4,50



155227



155142



P. 416

Mouse

Base, montatura e diffusori in metallo rifinito con vernice opaca e dettagli in cromo. Diffusori orientabili. Disponibile nelle finiture bianco o nero.

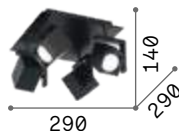

■ □ ⊕ IP20

1,900 Kg / 0,0157 m³
GU10 max 4 x 50W

€ 260

073583 ■ Bianco
156712 ■ Nero

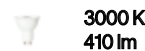

108292 € 3,00



P. 412



P. 694



Spot

Base, montatura e diffusori in metallo rifinito con vernice opaca e dettagli in cromo. Diffusori orientabili. Disponibile nelle finiture bianco o nero.

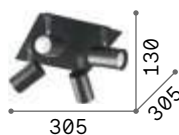

■ □ ⊕ IP20

1,320 Kg / 0,0139 m³
GU10 max 4 x 28W

€ 100

156774 ■ Bianco
156781 ■ Nero



108292 € 3,00



P. 412



P. 694





Oby

Montatura in metallo verniciato bianco opaco, con snodi cromati. Corpo luce orientabile con diffusore in materiale plastico bianco.

LED Sorgente luminosa LED 3000 K, 20.000 h di durata.



■ □ ⊕ IP20

1,210 Kg / 0,0058 m³
LED 24W / 2800 lm

€ 260

196718 Bianco

■ □ ⊕ IP20

0,870 Kg / 0,0038 m³
LED 18W / 2100 lm

€ 185

196701 Bianco





Rudy

Montatura in alluminio pressofuso verniciato a polveri bianco o nero. Diffusori orientabili in rotazione e inclinazione.

LED Lampadine LED GU10 7W 3000 K incluse. Cod. **123943**



229089 229065

294827 294810

760	540	760	540
125	125	110	110
1,230 Kg / 0,0057 m³ GU10 max 4 x 35W	1,080 Kg / 0,0041 m³ GU10 max 3 x 35W	1,230 Kg / 0,0057 m³ GU10 max 3 x 35W	1,080 Kg / 0,0041 m³ GU10 max 3 x 35W
€ 185	€ 127	€ 195	€ 150
229089 ■ Bianco 229072 ■ Nero	229065 ■ Bianco 229058 ■ Nero	294827 ■ Bianco 321523 ■ Nero	294810 ■ Bianco 321516 ■ Nero
3000 K 540 lm	3000 K 540 lm	3000 K 540 lm	3000 K 540 lm
123943 € 3,50	123943 € 3,50	123943 € 3,50	123943 € 3,50





Profilo

Base con fissaggio ad incasso e diffusore orientabile in metallo verniciato a polveri. Finiture: bianco, nero.

LED

Lampadine LED GU10 7W 3000 K incluse. Cod. **123943**



314716



314723

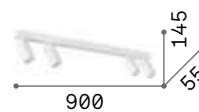

1,900 Kg / 0,0151 m³
GU10 max 4 x 28W

€ 185

328188 ■ Bianco
328195 ■ Nero

3000 K
540 lm

123943 € 3,50

0,940 Kg / 0,0078 m³
GU10 max 2 x 28W

€ 90

314716 ■ Bianco
314723 ■ Nero

3000 K
540 lm

123943 € 3,50



Glim

Montatura interamente in metallo verniciato a polveri di colore bianco o nero. Diffusore orientabile con lampadina sostituibile.

LED Lampadine LED GU10 10W 3000 K incluse. Cod. **189031**



200194



200231



P. 695

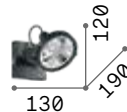
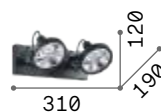

1,270 Kg / 0,0202 m³
GU10 max 4 x 50W

€ 304

200217 **Bianco**
200255 **Nero**

3000 K
750 lm

189031 € 15,00

0,890 Kg / 0,0074 m³
GU10 max 2 x 50W

€ 166

200200 **Bianco**
200248 **Nero**

3000 K
750 lm

189031 € 15,00

0,480 Kg / 0,0034 m³
GU10 max 1 x 50W

€ 86

200194 **Bianco**
200231 **Nero**

3000 K
750 lm

189031 € 15,00



Nodi

Montatura in metallo cromato oppure in ottone satinato. Diffusori in vetro bianco soffiato, acidato o trasparente e cromato.

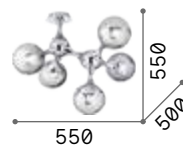

IP20

3,200 Kg / 0,1012 m³
E14 max 5 x 28W

€ 231

200484 Cromo

101200 3000 K
480 lm € 2,00

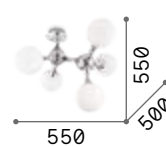

IP20

3,200 Kg / 0,1012 m³
E14 max 5 x 28W

€ 231

073712 Bianco
241050 Ottone

101200 3000 K
480 lm € 2,00



P. 175



Nodino

Montatura in metallo con finitura in cromo o in vernice opaca bianca. Diffusori in vetro bianco soffiato e acidato.

LED Lampadine LED G9 3W 3000 K incluse.
Cod. **209043**

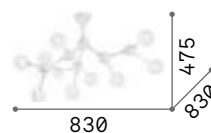

IP20

3,160 Kg / 0,3975 m³
G9 max 9 x 15W

€ 567

149622 **Bianco**
133393 **Cromo**

3000 K
510 lm
305486 € 6,00



Perlage

Montatura in metallo con struttura lineare a sezione tonda o circolare a sezione quadrata. Diffusori in vetro soffiato. Finiture: nero opaco con vetri ambra o pirex fumé oppure ottone satinato con vetri bianchi acidati.

LED Lampadine LED G9 3W 3000 K incluse.
Cod. **209043**



328423



328416



328409

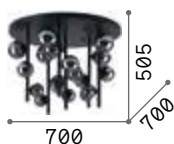

7,520 Kg / 0,1314 m³
G9 max 18 x 15W

€ 851

328393 Bianco
328386 Fumè
328379 Ambra

3000 K
510 lm

305486 € 6,00

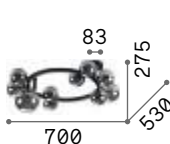

2,780 Kg / 0,0605 m³
G9 max 10 x 15W

€ 518

327815 Bianco
309286 Fumè
327808 Ambra

3000 K
510 lm

305486 € 6,00

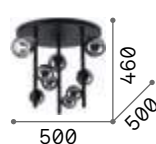

3,870 Kg / 0,0622 m³
G9 max 9 x 15W

€ 437

328423 Bianco
328416 Fumè
328409 Ambra

3000 K
510 lm

305486 € 6,00

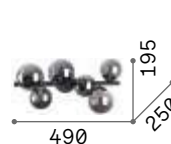

1,550 Kg / 0,0385 m³
G9 max 6 x 15W

€ 265

309279 Bianco
309262 Fumè
327822 Ambra

3000 K
510 lm

305486 € 6,00



P. 106



P. 423



P. 473



P. 498



Triumph

Base, bracci e copri porta lampade in metallo placcato. Colore: ottone invecchiato.

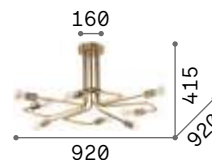

■  IP20

3,270 Kg / 0,0454 m³
E27 max 8 x 42W

€ 570

160313  Ottone

 **2200 K**
370 lm

151687 € 2,50



Birds

Montatura in metallo verniciato con disco decorativo in ottone satinato. Diffusori in vetro soffiato bianco acidato. Colore: nero opaco con dettaglio ottone satinato.

LED Lampadine LED G9 3W 3000 K incluse.
Cod. **209043**

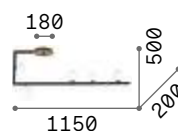

2,800 Kg / 0,1535 m³
G9 max 5 x 15W

€ 278

273631 ■ Nero

3000 K
510 lm

305486 € 6,00



P. 105 P. 421 P. 473 P. 497



Multiflex

Montatura in metallo rifinito con vernice opaca. Bracci flessibili metallici, rivestiti in gomma.

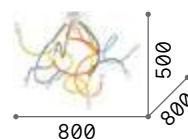

IP20

4,330 Kg / 0,0353 m³
E14 max 8 x 28W

€ 410

159010  Color

 3000 K
420 lm

101217 € 2,00



Octopus

Base in metallo rifinito opaco.
Bracci flessibili rivestiti di gomma di colore bianco o multicolor. Diffusori in vetro trasparente soffiato e sabbato.

LED Lampadine LED G9 3W 3000 K incluse.
Cod. **209043**

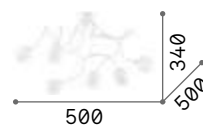

3,000 Kg / 0,0390 m³
G9 max 6 x 28W

€ 340

174921 Bianco
174976 Color

3000 K
510 lm
305486 € 6,00



Maracas

Montatura interamente in metallo
rifinito in ottone satinato. Diffusori
orientabili in vetro soffiato
trasparente.



Lampadine LED G4 2W 3000 K incluse.
Cod. **222257**

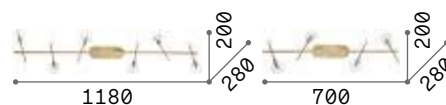

1,280 Kg / 0,0242 m³
G4 max 6 x 2W

€ 374

200361 ■ **Ottone**

3000 K
200 lm

222257 **€ 4,00**



0,960 Kg / 0,0142 m³
G4 max 4 x 2W

€ 269

200354 ■ **Ottone**

3000 K
200 lm

222257 **€ 4,00**



P. 424



Gourmet

Rosone e montatura in metallo verniciato opaco. Diffusori in vetro incamiciato bianco, soffiato e acidato. Finiture: nero e ottone satinato.

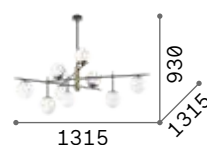

■ □ IP20

5,400 Kg / 0,1765 m³
E14 max 9x28W

€ 615

289489 ■ Nero

💡 3000 K
420 lm

101217 € 2,00

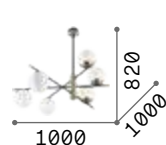

■ □ IP20

3,670 Kg / 0,1017 m³
E14 max 6x28W

€ 415

289496 ■ Nero

💡 3000 K
420 lm

101217 € 2,00



Atlas

Montatura in metallo verniciato opaco con bracci posizionabili. Diffusori in vetro soffiato bianco acidato. Finiture: bianco, nero, oro.



Lampadine LED G9 3W 3000 K incluse.
Cod. **209043**



328201



311357



311340

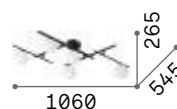

2,400 Kg / 0,0591 m³
G9 max 5 x 4W

€ 299

328225 Bianco
328218 Nero
311364 Oro

3000 K
510 lm
305486 € 6,00

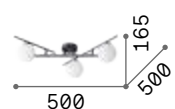

1,500 Kg / 0,0397 m³
G9 max 3 x 4W

€ 195

328201 Bianco
311357 Nero
311340 Oro

3000 K
510 lm
305486 € 6,00



Cosmopolitan

Montatura in metallo rifinito con vernice opaca. Diffusori in vetro soffiato bianco acidato. Colori: nero con dettagli ottone satinato.



Lampadine LED G9 3W 3000 K incluse.
Cod. 209043

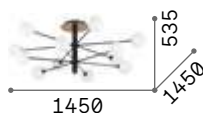

7,600 Kg / 0,1787 m³
G9 max 12 x 15W

€ 700

273709 ■ Nero

3000 K
510 lm
305486 € 6,00

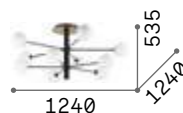

6,500 Kg / 0,1397 m³
G9 max 10 x 15W

€ 600

273693 ■ Nero

3000 K
510 lm
305486 € 6,00

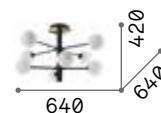

3,040 Kg / 0,0579 m³
G9 max 8 x 15W

€ 330

328485 ■ Nero

3000 K
510 lm
305486 € 6,00



Angolo

Montatura in metallo verniciato a polveri o placcato. Diffusori in vetro bianco, soffiato e acidato. Finiture: nero oppure ottone satinato.



Lampadine LED G9 3W 3000 K incluse.
Cod. **209043**



284286

284330



IP20

1,650 Kg / 0,0377 m³
G9 max 3 x 28W

€ 185

284286 ■ Nero
284330 ■ Ottone

3000 K
510 lm
305486 € 6,00



P. 476 P. 500



Lingotto

Montatura in metallo verniciato: base nera opaca e telaio ottone opaco oppure completamente nero opaco. Diffusori in vetro incamiciato bianco, soffiato e acidato.



5,580 Kg / 0,0540 m³
E14 max 4 x 28W

€ 315

327860 ■ Nero
198156 ■ Ottone

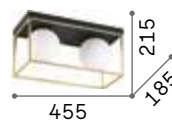

3,370 Kg / 0,0451 m³
E14 max 2 x 28W

€ 210

304137 ■ Nero
198149 ■ Ottone



1,810 Kg / 0,0183 m³
E14 max 1 x 28W

€ 125

327853 ■ Nero
198132 ■ Ottone

3000 K
420 lm
101217 € 2,00

3000 K
420 lm
101217 € 2,00

3000 K
420 lm
101217 € 2,00

P. 100 P. 477



Ping Pong

Montatura in metallo rifinito con vernice a polveri. Diffusori con sfere in acrilico trasparente satinato. Driver integrato. Finiture: bianco, nero, ottone spazzolato.



LED Sorgente luminosa LED 3000 K, 50.000 h di durata.



■ ■ □ IP20

1,290 Kg / 0,0119 m³
LED 18W / 1500 lm

€ 240

328256 ■ Bianco
313290 ■ Nero
328263 ■ Ottone



■ ■ □ IP20

0,860 Kg / 0,0077 m³
LED 12W / 1000 lm

€ 170

328232 ■ Bianco
313283 ■ Nero
328249 ■ Ottone



P. 428 P. 472 P. 505



Binomio

Montatura in metallo. Diffusori in vetro soffiato bianco acidato con fissaggio a vite. Finiture: bianco, nero, ottone spazzolato.

LED Lampadine LED G9 3W 3000 K incluse.
Cod. **209043**

<p>860 150 120°</p>	<p>557 150 120°</p>
<p>1,550 Kg / 0,0240 m³ G9 max 3 x 4W</p>	<p>1,200 Kg / 0,0145 m³ G9 max 2 x 4W</p>
<p>€ 130</p>	<p>€ 90</p>
<p>328454 Bianco 310688 Nero 328461 Ottone</p>	<p>328430 Bianco 310671 Nero 328447 Ottone</p>
<p>3000 K 510 lm</p>	<p>3000 K 510 lm</p>
<p>305486 € 6,00</p>	<p>305486 € 6,00</p>



Hermes

Base e montatura in metallo placcato. Diffusori in vetro incamiciato bianco, soffiato e acidato. Finiture: bianco oppure ottone satinato.

LED

Lampadine LED G9 3W 3000 K incluse.
Cod. 209043



316680

288277

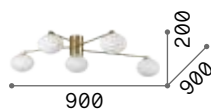

2,500 Kg / 0,0296 m³
G9 max 5 x 28W

€ 350

316680 Bianco
288277 Ottone

305486 3000 K
510 lm

305486 € 6,00

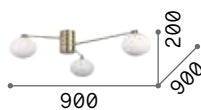

1,700 Kg / 0,0252 m³
G9 max 3 x 28W

€ 250

322674 Bianco
288260 Ottone

305486 3000 K
510 lm

305486 € 6,00

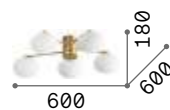

2,700 Kg / 0,0209 m³
G9 max 5 x 28W

€ 320

322698 Bianco
316697 Ottone

305486 3000 K
510 lm

305486 € 6,00

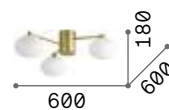

2,500 Kg / 0,0209 m³
G9 max 3 x 28W

€ 220

322667 Bianco
317007 Ottone

305486 3000 K
510 lm

305486 € 6,00



Ninfea

Base in metallo verniciato a polveri o placcato. Diffusori in vetro incamiciato bianco, soffiato e acidato. Finiture: bianco oppure ottone satinato.

LED Lampadine LED GX53 9W 3000 K incluse. Cod. **123936**



306957

293653



460



360



2,550 Kg / 0,0484 m³
GX53 max 3 x 15W

€ 275

306964 **Bianco**
293660 **Ottone**

1,700 Kg / 0,0302 m³
GX53 max 2 x 15W

€ 195

306957 **Bianco**
293653 **Ottone**

3000 K
910 lm

123936 € 5,00

3000 K
910 lm

123936 € 5,00



P. 431



P. 471



Penta

Montatura in metallo. Diffusori in vetro soffiato bianco acidato con fissaggio a vite. Finiture: oro spazzolato.



Lampadine LED G9 3W 3000 K incluse.
Cod. **209043**



■ ■ □ IP20 INCLUSA

1,700 Kg / 0,0239 m³
G9 max 3 x 4W

€ 160

314822 ■ Oro

3000 K
510 lm

305486 € 6,00

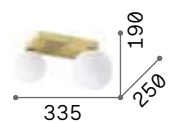

■ ■ □ IP20 INCLUSA

1,020 Kg / 0,0179 m³
G9 max 2 x 4W

€ 105

314815 ■ Oro

3000 K
510 lm

305486 € 6,00



P. 431



Lumiere

Montatura e dettagli in metallo verniciato nero opaco. Diffusore tubolare centrale bianco. Elementi decorativi in vetro soffiato bianco lucido e trasparente grigio.

LED Sorgente luminosa LED 3000 K, 25.000 h di durata.



■ □ IP20

1,760 Kg / 0,0197 m³
LED 18W / 2250 lm

€ 160

314235 Bianco

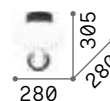

■ □ IP20

2,070 Kg / 0,0415 m³
LED 18W / 2250 lm

€ 180

314228 Bianco



P. 178



P. 465



P. 496



Daisy

Base in metallo rifinita con foglia oro. Diffusori in vetro soffiato bianco, acidato e con rigatura in rilievo.

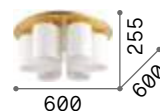

■ □ IP20

12,000 Kg / 0,1711 m³
E27 max 6 x 52W

€ 440

247779 ■ Oro

💡 3000 K
900 lm

123899 € 3,50



Compo

Montatura in metallo cromato o verniciato bianco opaco. Elementi diffusori in vetro soffiato bianco incamiciato e acidato o trasparente fumè.

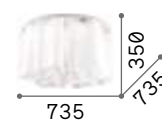

IP20

IP20

17,200 Kg / 0,3008 m³
E27 max 10 x 52W

9,900 Kg / 0,1918 m³
E27 max 6 x 52W

€ 1000

€ 570

125510 Bianco
172804 Fumè

125503 Bianco
172828 Fumè

3000 K
910 lm

3000 K
910 lm

119571 € 3,50

119571 € 3,50



125503



172828



Roma

Montatura e dettagli in metallo cromato. Diffusore con elementi quadrati in cristallo molato sulla fascia laterale e vetro sabbato sul fondo.



Lampadine LED G9 3W 3000 K incluse.
Cod. 209043

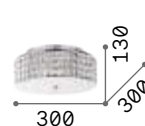
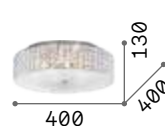

9,600 Kg / 0,1220 m³
G9 max 12 x 40W

6,800 Kg / 0,0905 m³
G9 max 9 x 40W

4,800 Kg / 0,0588 m³
G9 max 6 x 40W

2,500 Kg / 0,0390 m³
G9 max 4 x 40W

€ 715

€ 610

€ 400

€ 290

087870 Cromo

087863 Cromo

000657 Cromo

093093 Cromo



P. 438 P. 486

3000 K
510 lm

3000 K
510 lm

3000 K
510 lm

3000 K
510 lm

305486 € 6,00

305486 € 6,00

305486 € 6,00

305486 € 6,00



Pashà

Montatura in metallo. Diffusore composto da filari di perle in cristallo molato e fondo chiuso da vetro circolare sabbato.



164991



165004



P. 205 P. 438



13,000 Kg / 0,1809 m³
E14 max 14 x 40W

€ 1145

164991 Cromo
165004 Oro

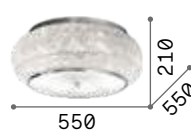

8,800 Kg / 0,1040 m³
E14 max 10 x 40W

€ 980

100746 Cromo
100791 Oro

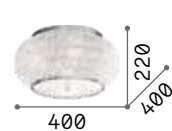

6,200 Kg / 0,0529 m³
E14 max 6 x 40W

€ 780

100784 Cromo
100807 Oro

3000 K
480 lm
101200 € 2,00

3000 K
480 lm
101200 € 2,00

3000 K
480 lm
101200 € 2,00



King

Diffusore composto da anelli in metallo cromato o dorato con ottagononi di cristallo incastonati all'interno.

LED

Lampadine LED G9 3W 3000 K incluse.
Cod. **209043**



073255



073262



P. 200

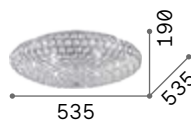

IP20

6,250 Kg / 0,0946 m³
G9 max 9 x 40W

€ 690

073255 Cromo
073262 Oro

3000 K
510 lm

305486 € 6,00

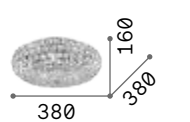

IP20

3,200 Kg / 0,0487 m³
G9 max 5 x 40W

€ 400

075419 Cromo
073187 Oro

3000 K
510 lm

305486 € 6,00

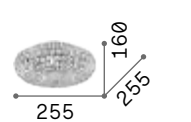

IP20

1,750 Kg / 0,0240 m³
G9 max 3 x 40W

€ 235

075389 Cromo
075402 Oro

3000 K
510 lm

305486 € 6,00







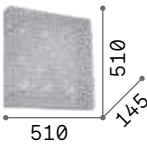
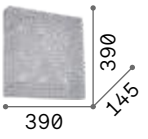
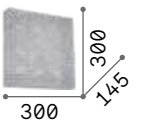

Admiral

Diffusore composto da anelli in metallo saldati tra loro e da elementi in cristallo molato incastonati all'interno.

LED Lampadine LED G9 3W 3000 K incluse.
Cod. **209043**



		
		
7,050 Kg / 0,0731 m³ G9 max 8 x 40W	4,580 Kg / 0,0486 m³ G9 max 6 x 40W	3,000 Kg / 0,0318 m³ G9 max 4 x 40W
€ 855	€ 555	€ 355
080352 Cromo	080345 Cromo	080338 Cromo
 3000 K 510 lm	 3000 K 510 lm	 3000 K 510 lm
305486 € 6,00	305486 € 6,00	305486 € 6,00



Armony

Montatura in metallo verniciato opaco. Elementi decorativi pendenti in filo metallico con perle di vetro trasparente cromato. Finiture: bianco.



LED

Sorgente luminosa LED 3000 K, 30.000 h di durata.

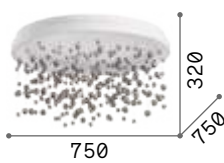
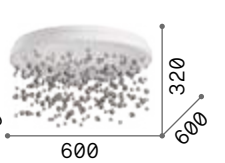
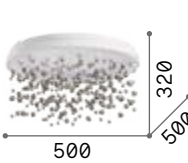
		
<p>■ □ IP20 ⌚</p> <p>10,500 Kg / 0,0961 m³ LED 70W / 6700 lm</p> <p>€ 600</p> <p>315812 Bianco</p>	<p>■ □ IP20 ⌚</p> <p>7,830 Kg / 0,0634 m³ LED 56W / 5450 lm</p> <p>€ 450</p> <p>315805 Bianco</p>	<p>■ □ IP20 ⌚</p> <p>5,050 Kg / 0,0393 m³ LED 48W / 4700 lm</p> <p>€ 315</p> <p>328492 Bianco</p>









022239

Neve

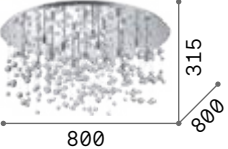
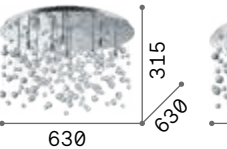
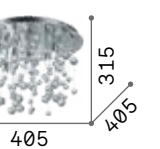
Montatura in metallo placcato.
Elementi decorativi pendenti con
sfere di vetro fissate a fili di nylon.
Colore montatura: cromo. Colore
vetri: trasparente.

LED

Lampadine LED G9 3W 3000 K incluse.
Cod. **209043**

		
800	630	405
		
11,250 Kg / 0,1524 m ³ G9 max 15 x 40W	7,420 Kg / 0,0920 m ³ G9 max 12 x 40W	3,590 Kg / 0,0344 m ³ G9 max 8 x 40W
€ 760	€ 510	€ 305
030784 Cromo	022239 Cromo	022222 Cromo
 3000 K 510 lm	 3000 K 510 lm	 3000 K 510 lm
305486 € 6,00	305486 € 6,00	305486 € 6,00

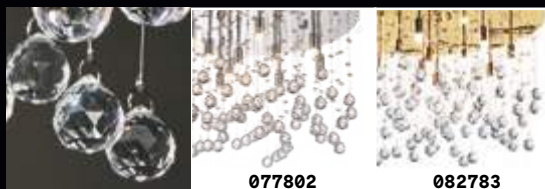

Moonlight

Montatura in metallo con finitura disponibile in cromo o dorato. Pendagli con ottagononi e sfere in cristallo molato.

LED Lampadine LED G9 3W 3000 K incluse.
Cod. 209043

IP20	IP20	IP20	IP20
11,800 Kg / 0,1524 m ³ G9 max 15 x 40W	6,000 Kg / 0,0933 m ³ G9 max 12 x 40W	2,900 Kg / 0,0398 m ³ G9 max 8 x 40W	1,500 Kg / 0,0144 m ³ G9 max 5 x 40W
€ 875	€ 605	€ 338	€ 170
077819 Cromo 082790 Oro	077802 Cromo 082783 Oro	077796 Cromo 080932 Oro	094649 Cromo 094663 Oro
3000 K 510 lm	3000 K 510 lm	3000 K 510 lm	3000 K 510 lm
305486 € 6,00	305486 € 6,00	305486 € 6,00	305486 € 6,00

Royal

Montatura circolare e portalampe in metallo cromato.
Pendagli con elementi in cristallo molato ottagonali, quadrati, rettangolari e gocce finali.

LED Lampadine LED G9 3W 3000 K incluse.
Cod. **209043**

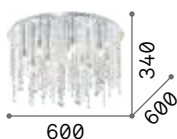

IP20

5,900 Kg / 0,0881 m³
G9 max 12 x 40W

€ 590

053004 Cromo

3000 K
510 lm

305486 € 6,00

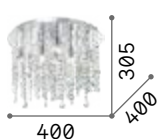

IP20

2,840 Kg / 0,0379 m³
G9 max 8 x 40W

€ 310

052991 Cromo

3000 K
510 lm

305486 € 6,00



Rain

Montatura in metallo cromato.
Pendagli con elementi in cristallo molato in varie forme e gocce finali.

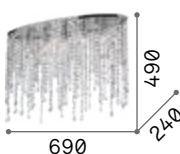

IP20

3,820 Kg / 0,0225 m³
E14 max 5 x 40W

€ 340

008455 Cromo

3000 K
470 lm

101224 € 2,00

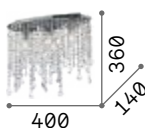

IP20

1,800 Kg / 0,0094 m³
E14 max 3 x 40W

€ 170

008370 Cromo

3000 K
470 lm

101224 € 2,00



P. 201



Magnolia

Montatura in metallo con finitura oro. Elementi decorativi in cristallo molato trasparente. Nella parte superiore si alternano elementi trasparenti ed elementi fumè.

LED Lampadine LED G9 3W 3000 K incluse.
Cod. **209043**

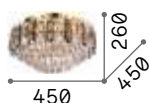

IP20

9,780 Kg / 0,0984 m³

G9 max 7 x 15W

€ 620

241296 **Oro**

3000 K
510 lm

305486 € 6,00

Dubai

Montatura in metallo con finitura cromo o ottone. Elementi decorativi con perle, ottagoni e prismi in cristallo molato trasparente.

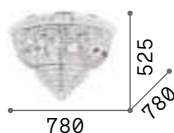

IP20

14,290 Kg / 0,3881 m³

E14 max 24 x 28W

€ 1430

243566 **Cromo**
243498 **Ottone**

3000 K
470 lm

101224 € 2,00

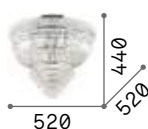

IP20

6,310 Kg / 0,1413 m³

E14 max 6 x 28W

€ 950

207186 **Cromo**
201016 **Ottone**

3000 K
470 lm

101224 € 2,00

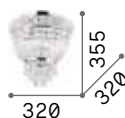

IP20

3,010 Kg / 0,0392 m³

E14 max 3 x 28W

€ 475

207162 **Cromo**
200996 **Ottone**

3000 K
470 lm

101224 € 2,00



P. 208



P. 439



207186



201016



Martinez

Montatura in metallo cromato o dorato. Elementi decorativi con catene di ottagoni e barre in cristallo molato trasparente.



166285



213569

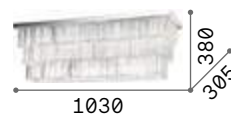

IP20

17,500 Kg / 0,0807 m³
E14 max 8 x 40W

€ 770

166285 Cromo
213569 Oro

3000 K
470 lm

101224 € 2,00



P. 202



Carlton

Montatura in metallo cromato o dorato. Elementi decorativi con catene di ottoni e barre in cristallo molato trasparente.



168937



213507

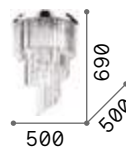

IP20

13,840 Kg / 0,1563 m³
E14 max 12 x 40W

€ 725

168937 Cromo
213507 Oro

101224 3000 K
470 lm

€ 2,00

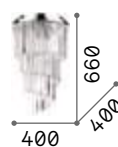

IP20

10,200 Kg / 0,1066 m³
E14 max 8 x 40W

€ 625

168920 Cromo

101224 3000 K
470 lm

€ 2,00



Lampade da parete

Interni

Indice alfabetico

Ali	387	Filo	392	Oby	415	Spot	412
Alma	394	Firenze	444	Opera	440	Strauss	443
Balance	371	Fix	366	Ovalino	382	Swan	440
Barber	415	Flash	380	Oz	362	Theo	393
Bean	402	Florian	442	Page	403	Tick	432
Binomio	429	Focus	398	Pan	430	Triplo	386
Birds	421	Frida	419	Pasha'	438	Triumph	424
Bonne Nuit	406	Gea	436	Paul	382	Tudor	387
Book	411	Gim	414	Pegaso	441	Winery	416
Bow	396	Gioconda	443	Peggy	365	Zig Zag	378
Box	367	Goose	400	Penta	431		
Camerino	388	Harem	446	Perlage	423		
Cantina	426	Hotel	437	Peter	445		
Carlton	439	Igor	420	Piano	409		
Carta	385	Io	399	Ping Pong	428		
Chalet	444	Kepler	422	Pipe	404		
Click	370	Komodo	408	Posta	368		
Clip	369	Linus	375	Pouche	365		
Corte	441	Lite	405	Pretty	388		
Cover	364	Look	381	Prive'	389		
Craft	374	Make-Up	395	Probe	410		
Cube	370	Mapa	384	Radio	417		
Delta	372	Maracas	424	Retro'	397		
Desk	374	Minimal	418	Riflesso	395		
Dodo	414	Mirror-10	396	Roma	438		
Dubai	439	Mirror-20	397	Rudy	413		
Dynamo	401	Moris	366	Santa	447		
Echo	376	Mouse	412	Set Up	434		
Eclissi	433	Negresco	442	Shower	427		
Edison	416	Newton	426	Sky	381		
Equinoxe	425	Ninfea	431	Smarties	385		
Essence	390	Nordik	436	Soda	383		

Carta

Pag 385



new



Oz 362



Cover 364



Click 370



Cube 370



FlashGesso 380



Sky 381



Tripla 386



Ali 387



Alma 394



Make Up 395



Goose 400



Dynamo 401



Probe 410



Book 411



























































Winery 416



Edison 416





























Interni

Indice icone

						
Peggy 365	Pouche 365	Fix 366	Moris 366	Box 367	Posta 368	Clip 369
						
Balance 371	Delta 372	Desk 374	Craft 374	Linus 375	Echo 376	Zig Zag 378
						
Look 381	Paul 382	Ovalino 382	Soda 383	Mapa 384	Smarties 385	Carta 385
						
Tudor 387	Camerino 388	Pretty 388	Privè 389	Essence 390	Filo 392	Theo 393
						
Riflesso 395	Bow 396	Mirror-10 396	Mirror-20 397	Retrò 397	Focus 398	IO 399
						
Bean 402	Page 403	Pipe 404	Lite 405	Bonne Nuit 406	Komodo 408	Piano 409
						
Mouse 412	Spot 412	Rudy 413	Gim 414	Dodo 414	Oby 415	Barber 415
						
Radio 417	Minimal 418	Frida 419	Igor 420	Birds 421	Kepler 422	Perlage 423

Interni

Indice icone

		<small>new</small> 				<small>new</small> 
Triumph 424	Maracas 424	Equinoxe 425	Cantina 426	Newton 426	Shower 427	Ping Pong 428
	<small>new</small> 					
Penta 431	Ninfea 431	Tick 432	Eclissi 433	Set Up 434	Nordik 436	Gea 436
						
Pashà 438	Carlton 439	Dubai 439	Opera 440	Swan 440	Corte 441	Pegaso 441
						
Gioconda 443	Strauss 443	Firenze 444	Chalet 444	Peter 445	Harem 446	Santa 447



Binomio 429



Pan 430



Hotel 437



Roma 438



Negresco 442



Florian 442



Binomio

Pag 429

Oz new

Base e montatura in metallo verniciato a polveri o placcato. Diffusore in gomma opale. Disponibile nelle finiture bianco, nero o ottone spazzolato. Disponibile anche in versione dimmerabile DALI/Push.

LED Sorgente luminosa LED 2700 / 3000 / 4000 K, 30.000 h di durata.

Sorgente	LED SMD	Durata LED	30.000 h
Potenza	26W / 28W	Classe	II
Driver incluso	On/Off / DALI/Push	isolamento	
Driver disponibili	No	IP	20
CCT	2700 K / 3000 K / 4000 K	Materiale	Alluminio
CRI	≥90		

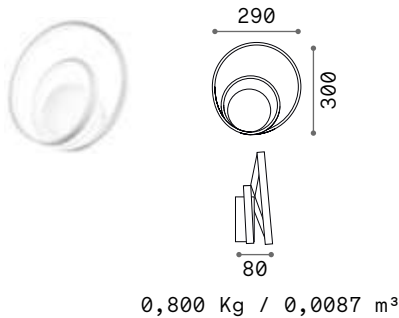

LED SMD Driver incluso

Potenza	Driver	Lumen	CCT	Finitura	Codice	€		
26 W	On-Off	2450 lm	2700 K	Bianco	342221	150 <small>new</small>		
				Nero	342238	150 <small>new</small>		
				Ottone	342245	150 <small>new</small>		
		2500 lm	3000 K	Bianco	253695	150		
				Nero	269399	150		
				Ottone	269405	150		
				2650 lm	4000 K	Bianco	342252	150 <small>new</small>
						Nero	342269	150 <small>new</small>
						Ottone	342276	150 <small>new</small>
28 W	DALI/Push	2500 lm	3000 K	Bianco	304489	230		
				Nero	304496	230		
				Ottone	304502	230		



253695



269399



269405



Cover

Corpo luce in alluminio verniciato a polveri di colore bianco o nero. Diffusore in materiale plastico opale. Sorgente luminosa a led integrati con emissione di luce riflessa.

LED Sorgente luminosa LED 3000 K, 30.000 h di durata.

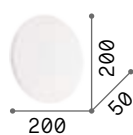

0,690 Kg / 0,0028 m³
LED 11W / 1000 lm

€ 100

195711 Bianco
195759 Nero

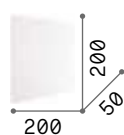

0,860 Kg / 0,0028 m³
LED 11W / 1000 lm

€ 100

195735 Bianco
195773 Nero

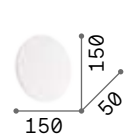

0,390 Kg / 0,0018 m³
LED 9,5W / 730 lm

€ 88

195704 Bianco
195742 Nero

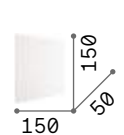

0,510 Kg / 0,0018 m³
LED 9,5W / 730 lm

€ 88

195728 Bianco
195766 Nero

Peggy

Base e montatura in metallo verniciato a polveri con finitura bianca. Diffusore in acrilico satinato. Emissione luce indiretta.

LED Sorgente luminosa LED 3000 K, 50.000 h di durata.

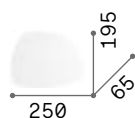

■ IP20

0,710 Kg / 0,0068 m³
LED 15W / 1500 Lm

€ 170

257242 Bianco

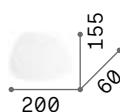

■ IP20

0,520 Kg / 0,0030 m³
LED 10,5W / 1080 Lm

€ 110

257235 Bianco



Pouche

Montatura in metallo rifinito con vernice a polveri di colore bianco. Diffusore in acrilico trasparente satinato. Emissione luce indiretta.

LED Sorgente luminosa LED 3000 K, 20.000 h di durata.



■ IP20

1,440 Kg / 0,0055 m³
LED 15W / 2000 Lm

€ 110

259352 Bianco



■ IP20

1,120 Kg / 0,0055 m³
LED 15W / 2000 Lm

€ 110

259345 Bianco



Fix

Base in metallo con finitura bianca opaca. Diffusore-dissipatore in lastra d'alluminio da 6 mm di spessore. LED integrati.

LED Sorgente luminosa LED 3000 K, 20.000 h di durata.

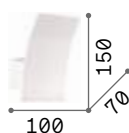

■ □ IP20

0,390 Kg / 0,0050 m³

LED 5,5W / 440 lm

€ 100

117867 ■ Bianco



Moris

Montatura in metallo cromato.
Diffusore in vetro soffiato bianco.

LED Lampadine LED G9 3W 3000 K incluse.
Cod. 209043



■ □ IP20

0,520 Kg / 0,0071 m³

G9 max 2x40W

€ 90

034546 ■ Bianco

■ 3000 K
510 lm

305486 € 6,00





Box

Montatura in metallo cromato.
Diffusore in vetro soffiato
incamiciato e acidato. Colore:
bianco.

LED Lampadine LED G9 3W 3000 K incluse.
Cod. **209043**

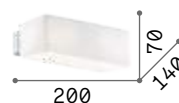

0,660 Kg / 0,0100 m³
G9 max 2 x 4W

€ 80

009537 Bianco

3000 K
510 lm

305486 € 6,00



Posta

Corpo luce in metallo disponibile in alluminio spazzolato o smaltato bianco. Diffusore composto di tre vetri trasparenti smerigliati.



051963



009940



620



1,560 Kg / 0,0156 m³
E14 max 4 x 40W

€ 95

051987 Bianco
009957 Alluminio

3000 K
480 lm

101200 € 2,00



500



1,270 Kg / 0,0136 m³
E14 max 3 x 40W

€ 87

051970 Bianco
009933 Alluminio

3000 K
480 lm

101200 € 2,00



360



0,950 Kg / 0,0098 m³
E14 max 2 x 40W

€ 75

051963 Bianco
009940 Alluminio

3000 K
480 lm

101200 € 2,00



Clip

Corpo luce interamente in lamina di metallo con varie finiture. Nella versione piccola, diffusori in vetro pirex sabbato.

LED

Lampadine LED G9 3W 3000 K incluse nei modelli: **049236, 091136, 049229, 091129 e 170923**. Cod. **209043**

	014166		
	088273		
	031361		
	088266	1,210 Kg / 0,0161 m³ E27 max 2 x 60W	0,680 Kg / 0,0035 m³ G9 max 2 x 40W
	187365	€ 107	€ 95
		014166 Bianco	049236 Bianco
		088273 Argento	091136 Argento
		031361 Cromo	049229 Cromo
		088266 Oro	091129 Oro
		187365 Coffee	170923 Coffee
		3000 K 430 lm	3000 K 510 lm
		101279 € 2,00	305486 € 6,00

Click

Corpo luce interamente in alluminio verniciato a polveri con finitura bianca. Struttura interna che riflette il fascio luminoso sia sopra che sotto.

LED Sorgente luminosa LED 3000 K, 20.000 h di durata.

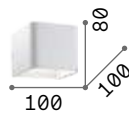
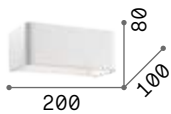

■  IP20

■  IP20

0,600 Kg / 0,0040 m³
LED 12W / 1200 lm

0,400 Kg / 0,0019 m³
LED 6W / 520 lm

€ 84

€ 62

017518  Bianco

051444  Bianco



Cube

Corpo luce dissipatore interamente in lastra d'alluminio da 6 mm di spessore. Rifinito con vernice a polveri. LED integrati.

LED Sorgente luminosa LED 3000 K, 30.000 h di durata.

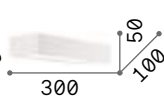

■  IP20

■  IP20

1,390 Kg / 0,0055 m³
LED 14,5W / 1800 lm

0,800 Kg / 0,0028 m³
LED 8W / 900 lm

€ 195

€ 145

161792  Bianco

161785  Bianco





Balance

Montatura in alluminio verniciato a polveri. Diffusore orientabile con vetro trasparente, smerigliato all'interno. Finiture: bianco, nero.

LED Sorgente luminosa LED 3000 K, 30.000 h di durata.



■ IP20

2,200 Kg / 0,0111 m³
LED 24W / 3100 lm

€ 230

287584 ■ Bianco
321561 ■ Nero

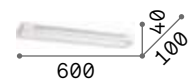

■ IP20

1,600 Kg / 0,0073 m³
LED 17W / 2200 lm

€ 170

287577 ■ Bianco
321554 ■ Nero

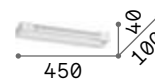

■ IP20

1,200 Kg / 0,0056 m³
LED 12W / 1450 lm

€ 135

287560 ■ Bianco
321547 ■ Nero

Delta

Corpo luce in alluminio verniciato a polveri. Diffusori in policarbonato opale lucido. Emissione luce sopra e sotto. Colori: bianco o nero.

Sorgente	LED SMD	Classe	I
Potenza	10W / 37W	isolamento	
Driver incluso	On/Off	IP	20
Driver disponibili	No	Materiale	Alluminio
CCT	3000 K / 4000 K		
CRI	≥90		
Durata LED	35.000 h		

LED SMD

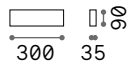

0,450 Kg/0,0030 m³

Potenza	Angolo	Lumen	CCT	Finitura	Codice	€
10 W	120°+120°	1700 lm	3000K	Bianco	345154	64 <i>new</i>
				Nero	336510	64 <i>new</i>
		1800 lm	4000 K	Bianco	345161	64 <i>new</i>
				Nero	345178	64 <i>new</i>

LED SMD

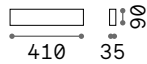

0,580 Kg/0,0042 m³

Potenza	Angolo	Lumen	CCT	Finitura	Codice	€
14 W	120°+120°	1550 lm	3000K	Bianco	316789	81 <i>new</i>
				Nero	345185	81 <i>new</i>
		1650 lm	4000 K	Bianco	345192	81 <i>new</i>
				Nero	345208	81 <i>new</i>

LED SMD

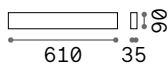

0,950 Kg / 0,0058 m³

Potenza	Angolo	Lumen	CCT	Finitura	Codice	€
19,5 W	120°+120°	2200 lm	3000 K	Bianco	287645	110
				Nero	287638	110
		2250 lm	4000 K	Bianco	307015	110
				Nero	307022	110

LED SMD

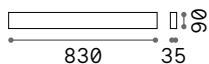

0,900 Kg / 0,0078 m³

Potenza	Angolo	Lumen	CCT	Finitura	Codice	€
30 W	120°+120°	3350 lm	3000 K	Bianco	287621	160
				Nero	287614	160
		3500 lm	4000 K	Bianco	307039	160
				Nero	307046	160

LED SMD

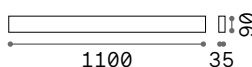

2,400 Kg / 0,0102 m³

Potenza	Angolo	Lumen	CCT	Finitura	Codice	€
37 W	120°+120°	4300 lm	3000 K	Bianco	287607	185
				Nero	287591	185
		4550 lm	4000 K	Bianco	307053	185
				Nero	307060	185



345154



287645



287638

Desk

Corpo luce in alluminio verniciato a polveri con finitura bianca o nera. Diffusori in acrilico satinato. Emissione luce sopra e sotto.

LED Sorgente luminosa LED 3000 K, 30.000 h di durata.



■  IP20

0,640 Kg / 0,0045 m³

LED 12,5W / 900 lm

€ 125

138251 ■ Bianco

173252 ■ Nero



P. 090



Craft

Base in metallo verniciato nero opaco. Corpo luce in legno naturale. Diffusore in policarbonato opale satinato. Emissione luce verso il basso.

LED Sorgente luminosa LED 3000 K, 20.000 h di durata.



■  IP20

0,800 Kg / 0,0057 m³

LED 12W / 1350 lm

€ 145

284477 ■ Legno



P. 091



P. 510





Linus

Lampada lineare in alluminio con illuminazione diretta e indiretta per applicazione a parete. La lampada è modulare e può essere proposta singolarmente oppure in linea continua. È disponibile in finitura bianca o nera. LED integrati; binning iniziale \leq 3-Step MacAdam; disponibile in temperatura di colore 3000 K e 4000 K; CRI \geq 80. Alimentatore dimmerabile 1-10V integrato di serie.

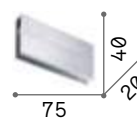
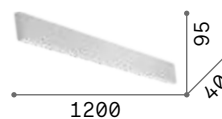

1,250 Kg / 0,0158 m³
LED 32W / 3000/3500 lm

€ 210

233840	Bianco	3000K
268095	Bianco	4000K
242019	Nero	3000K
268071	Nero	4000K

Connector
Non incluso
Optional

€ 6

233666

LED Sorgente luminosa LED 3000/4000 K, 50.000 h di durata.

+ Lampada con dimmer.



P. 624













Echo

Base e diffusore interamente in alluminio verniciato a polveri o placcato. Emissione luce indiretta. Colori: bianco, nero, ottone satinato.

LED Sorgente luminosa LED 3000 K, 50.000 h di durata.



	
600	400
50	50
■  IP20	■  IP20
0,930 Kg / 0,0051 m ³	0,640 Kg / 0,0032 m ³
LED 30W / 3250 lm	LED 20W / 2200 lm
€ 160	€ 140
273945  Bianco	273914  Bianco
285306  Nero	285283  Nero
285313  Ottone	285290  Ottone

Zig Zag new

Corpo luce in alluminio placcato o verniciato a polveri. Emissione luce indiretta a 360°. Colori: bianco, nero o ottone spazzolato.

LED Sorgente luminosa LED 2700 / 3000 / 4000 K, 50.000 h di durata.

Sorgente	LED SMD	Durata LED	50.000 h
Potenza	12,5W/23W/30W	Classe	I
Driver incluso	On/Off	isolamento	
Driver disponibili	No	IP	20
CCT	2700 K / 3000 K / 4000 K	Materiale	Alluminio
CRI	≥90		

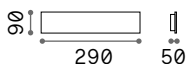

0,450 Kg/0,0020 m³

LED SMD Driver incluso

Dimensioni	Potenza	Driver	Lumen	CCT	Finitura	Codice	€
290x50	12,5W	On-Off	1450 lm	2700 K	Bianco	342641	95 <small>new</small>
					Bianco	179292	95
					Nero	179315	95
			Ottone	282121	95		
			1600 lm	4000 K	Bianco	277233	95

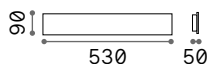

0,770 Kg/0,0033 m³

LED SMD Driver incluso

Dimensioni	Potenza	Driver	Lumen	CCT	Finitura	Codice	€
530x50	23 W	On-Off	2800 lm	2700 K	Bianco	342658	110 <small>new</small>
					Bianco	179308	110
					Nero	179322	110
			Ottone	282138	110		
			3200 lm	4000 K	Bianco	277240	110

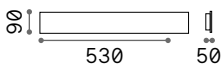

1,040 Kg/0,0047 m³

LED SMD Driver incluso

Dimensioni	Potenza	Driver	Lumen	CCT	Finitura	Codice	€
750x50	30 W	On-Off	3950 lm	2700 K	Bianco	342665	140 <small>new</small>
					Bianco	277219	140
					Nero	277226	140
			Ottone	287072	140		
			4550 lm	4000 K	Bianco	277257	140



179315



282121



Flash Gesso

Base in metallo smaltato. Corpo luce interamente in gesso. Doppia emissione luminosa: sopra e sotto.



Articolo adatto alla pittura e verniciatura.



214689



214696

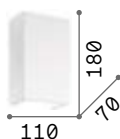

IP20

0,710 Kg / 0,0049 m³
G9 max 1x 40W

€ 55

214689 Bianco

3000 K
510 lm

305486 € 6,00



IP20

0,770 Kg / 0,0024 m³
G9 max 1x 40W

€ 54

214672 Bianco

3000 K
510 lm

305486 € 6,00

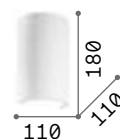

IP20

0,950 Kg / 0,0034 m³
G9 max 1x 40W

€ 50

214696 Bianco

3000 K
510 lm

305486 € 6,00

Sky

Base e diffusore in metallo placcato o verniciato opaco o decorato in foglia d'oro.

LED Lampadine LED GU10 7W 3000 K
incluse. Cod. **123943**

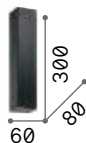

0,940 Kg / 0,0049 m³
GU10 max 2x28W

€ 116

126883 **Bianco**
126890 **Nero**
136899 **Oro**

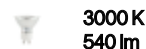

123943 € 3,50



P. 083



P. 301



126883 126890 136899



Look

Corpo luce in metallo con finitura rame, cromo, brunito o vernice opaca di colore bianco o nero.

LED Lampadine LED GU10 7W 3000 KK
incluse. Cod. **123943**



0,500 Kg / 0,0028 m³
GU10 max 2x28W

€ 80

096018 **Bianco**
094182 **Cromo**
095998 **Nero**
164847 **Rame**
164823 **Brunito**

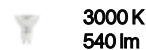

123943 € 3,50



096018 095998 164823



094182 164847



P. 078 P. 300 P. 506 P. 698

Paul

Base in metallo rifinito con vernice opaca. Diffusore in vetro soffiato, incamiciato e acidato. Disponibile con finitura bianca.

LED Lampadine LED G9 3W 3000 K incluse.
Cod. **209043**

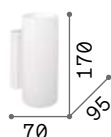

■  IP20 

0,560 Kg / 0,0064 m³

G9 max 2 x 40W

€ 65

060620  Bianco

 3000 K
510 lm

305486 € 6,00

Ovalino

Diffusore composto da elementi circolari in lastra di vetro curvata e acidata.



■  IP20

1,800 Kg / 0,0563 m³

E27 max 2 x 60W

€ 125

038025  Bianco

 3000 K
340 lm

101286 € 2,00



[P. 157](#)

[P. 284](#)



Soda

Corpo luce in gesso bianco. Base in metallo smaltato bianco. Diffusore inferiore in vetro trasparente satinato. Emissione luce sia sopra che sotto.



Articolo adatto alla pittura e verniciatura.

510	300
■ IP20	■ IP20
2,630 Kg / 0,0154 m ³ E14 max 2x 40W	1,100 Kg / 0,0068 m ³ E14 max 1x 40W
€ 100	€ 65
105727 Bianco	105710 Bianco
3000 K 420 lm	3000 K 420 lm
101217 € 2,00	101217 € 2,00



Mapa

Base e sistema di fissaggio in metallo bianco. Diffusore a sfera in vetro bianco soffiato e acidato.

LED Lampadine LED G9 3W 3000 K incluse nei modelli: **059808** e **310787**. Cod. **209043**

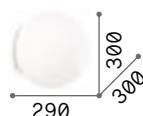

■ ■ □ IP20

1,660 Kg / 0,0647 m³
E27 max 1x 42W

€ 88

059822 Bianco

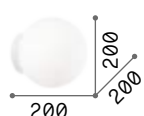

■ ■ □ IP20

0,900 Kg / 0,0259 m³
E27 max 1x 42W

€ 50

059815 Bianco



■ ■ □ IP20 INCLUSA

0,380 Kg / 0,0115 m³
G9 max 1x 15W

€ 44

059808 Bianco



■ ■ □ IP20 INCLUSA

0,230 Kg / 0,0025 m³
G9 max 1x 4W

€ 35

310787 Bianco



P. 168 P. 282 P. 470

3000 K
430 lm
101279 € 2,00

3000 K
430 lm
101279 € 2,00

3000 K
510 lm
305486 € 6,00

3000 K
510 lm
305486 € 6,00

Smarties

Base in metallo. Diffusore in vetro soffiato bianco acidato con sistema di fissaggio senza viti.

LED Lampadine LED G9 3W 3000 K incluse.
Cod. **209043**

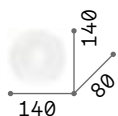

IP20

0,440 Kg / 0,0079 m³

G9 max 1x 15W

€ 46

014814 Bianco

305486 € 6,00

3000 K
510 lm



P. 154



P. 277



P. 469



Carta

Montatura in metallo verniciato bianco opaco. Diffusore in policarbonato con rivestimento ad effetto carta.

LED Lampadine LED G9 3W 3000 K incluse nel modello **317090**. Cod. **209043**

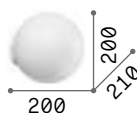

IP20

0,500 Kg / 0,0127 m³
E27 max 1x 25W

€ 85

317106 Bianco

101279 € 2,00

3000 K
430 lm



IP20

0,200 Kg / 0,0027 m³
G9 max 1x 15W

€ 65

317090 Bianco

305486 € 6,00

3000 K
510 lm



P. 170 P. 282 P. 468 P. 519



Triplo

Diffusore con triplo vetro, uno trasparente e piano alla base e due smerigliati ad acido e ricurvi sulla parte superiore. Elementi ferma vetro in metallo cromato.

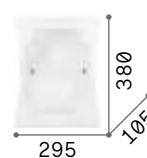

■  IP20

2,170 Kg / 0,0181 m³
E27 max 2 x 60W

€ 70

026480 Bianco

 3000 K
340 lm

101286 € 2,00

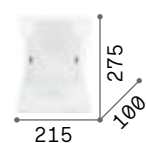

■  IP20

1,260 Kg / 0,0141 m³
E27 max 1 x 60W

€ 48

026473 Bianco

 3000 K
340 lm

101286 € 2,00

Ali

Diffusore in vetro bianco acidato composto da tre elementi: due laterali e uno frontale. Viti fermavetro cromate.

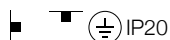

1,410 Kg / 0,0157 m³

E27 max 2 x 60W

€ 57

026558 Bianco

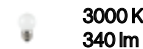

101286 € 2,00



Tudor

Base in metallo cromato. Diffusore composto da cornice in vetro trasparente molato e mezzo tubo in vetro pirex sabbato nella parte centrale.



1,900 Kg / 0,0214 m³

E14 max 4 x 40W

€ 100

051864 Trasparen.

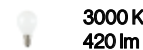

101217 € 2,00

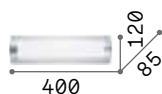

1,130 Kg / 0,0088 m³

E14 max 2 x 40W

€ 70

051857 Trasparen.

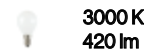

101217 € 2,00

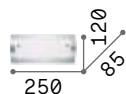

0,700 Kg / 0,0077 m³

E14 max 1 x 40W

€ 50

051840 Trasparen.

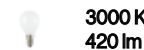







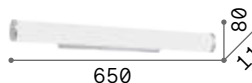

101217 € 2,00

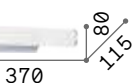

Camerino

Base in alluminio. Diffusore in vetro bianco soffiato e acidato, chiuso alle estremità da dischi in materiale acrilico trasparente.

		
650	520	370
■  IP20	■  IP20	■  IP20
1,170 Kg / 0,0157 m ³ E14 max 4 x 40W	0,960 Kg / 0,0123 m ³ E14 max 3 x 40W	0,780 Kg / 0,0097 m ³ E14 max 2 x 40W
€ 110	€ 100	€ 90
027104 ■ Bianco	027098 ■ Bianco	027081 ■ Bianco
 3000 K 420 lm	 3000 K 420 lm	 3000 K 420 lm
101217 € 2,00	101217 € 2,00	101217 € 2,00







Pretty

Base ed elementi laterali in alluminio verniciato a polveri. Diffusore cilindrico in policarbonato opale lucido. Finitura: bianco.

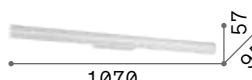
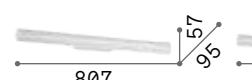
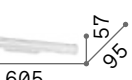
LED Sorgente luminosa LED 3000 K, 50.000 h di durata.

IP54 Grado di protezione IP54.

		
1070	807	605
■  IP54	■  IP54	■  IP54
1,250 Kg / 0,0169 m ³ LED 24W / 3050 lm	1,120 Kg / 0,0137 m ³ LED 18W / 2200 lm	0,960 Kg / 0,0105 m ³ LED 11,5W / 1500 lm
€ 145	€ 125	€ 100
287768 ■ Bianco	287775 ■ Bianco	287782 ■ Bianco





Privè

Corpo luce interamente in metallo con varie finiture. L'assenza di diffusore consente di montare una vasta gamma di lampade con attacco E14.

159423



045627



159508



179681



805



IP20

1,420 Kg / 0,0143 m³
E14 max 8x 40W

€ 128

159522 ■ Bianco
045634 ■ Cromo

IP20

1,100 Kg / 0,0095 m³
E14 max 6x 40W

€ 100

159423 ■ Bianco
045627 ■ Cromo
159508 ■ Nero
179681 ■ Ottone

3000 K
420 lm

101217 € 2,00

3000 K
420 lm

101217 € 2,00



Essence ^{new}

Base e corpo luce in alluminio verniciato a polveri. Diffusore in materiale acrilico opale. Emissione luce indiretta. Colori: bianco o nero.

LED Sorgente luminosa LED
2700/3000/4000 K, 30.000 h di durata.



285115



285108

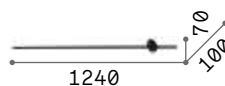

1240



IP20

1,040 Kg / 0,0163 m³
LED 19W / 2150/2300/2350 lm

€ 240

265575	Bianco	3000K
341019	Nero	2700K ^{new}
285108	Nero	3000K
341026	Nero	4000K ^{new}

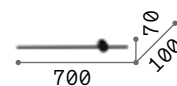

700



IP20

0,800 Kg / 0,0205 m³
LED 12W / 1300/1400/1450 lm

€ 182

285115	Bianco	3000K
340999	Nero	2700K ^{new}
265643	Nero	3000K
341002	Nero	4000K ^{new}





Filo

Base e montatura in alluminio verniciato a polveri o placcato. Diffusore inclinato a 45° in policarbonato opale opaco. Finiture: bianco, nero, ottone spazzolato.



Sorgente luminosa LED 3000 K, 20.000 h di durata.



310138



310145



327792

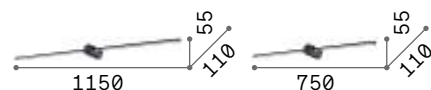

IP20

0,610 Kg / 0,0138 m³
LED 16W / 1950 lm

€ 220

327778 ■ Bianco
310152 ■ Nero
327785 ■ Ottone

IP20

0,500 Kg / 0,0093 m³
LED 13W / 1400 lm

€ 190

310138 ■ Bianco
310145 ■ Nero
327792 ■ Ottone



P. 084



P. 456



P. 502



Theo

Base e montatura in alluminio verniciato a polveri. Diffusore in policarbonato opale lucido. Finiture: bianco, nero.

LED Sorgente luminosa LED 3000 K, 30.000 h di durata.

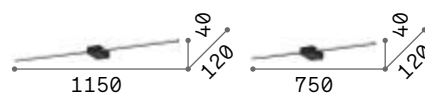
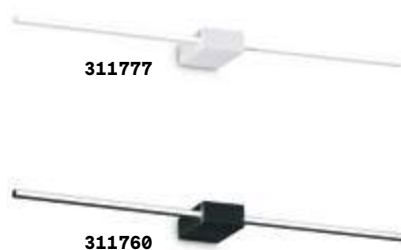

IP20

0,600 Kg / 0,0168 m³
LED 20,5W / 1350 lm

€ 145

327945 ■ Bianco
311784 ■ Nero

IP20

0,520 Kg / 0,0112 m³
LED 13,5W / 900 lm

€ 125

311777 ■ Bianco
311760 ■ Nero



Alma

Corpo luce in metallo rifinito ottone satinato, cromo o con vernice a polveri bianco. Diffusore fisso in materiale plastico colore opale.

LED Sorgente luminosa LED 3000 K, 30.000 h di durata.



■ □ IP20

0,660 Kg / 0,0264 m³
LED 18W / 2050 lm

€ 170

225029 □ Bianco
224992 ■ Cromo
225005 ■ Ottone

■ □ IP20

0,650 Kg / 0,0162 m³
LED 12,5W / 1350 lm

€ 135

224985 □ Bianco
224930 ■ Cromo
224954 ■ Ottone

Make Up

Base e corpo luce in alluminio verniciato a polveri. Diffusore in acrilico trasparente satinato. Emissione luce in basso. Finiture: bianco.

LED Sorgente luminosa LED 3000 K, 50.000 h di durata.

IP54 Grado di protezione IP54.

900	600	450
■ □ IP54	■ □ IP54	■ □ IP54
1,400 Kg / 0,0129 m ³ LED 27W / 3250 lm	1,200 Kg / 0,0088 m ³ LED 18W / 2200 lm	1,000 Kg / 0,0067 m ³ LED 12W / 1350 lm
€ 160	€ 120	€ 100
287676 Bianco	287669 Bianco	287652 Bianco



Riflesso new

Montatura in metallo verniciato opaco o placcato. Diffusore in acrilico trasparente satinato inclinato a 45°. Colori: bianco, cromo o nero.

LED Sorgente luminosa LED 3000 K, 20.000 h di durata.

IP54 Grado di protezione IP54.

820	620	420
■ ⊕ IP54	■ ⊕ IP54	■ ⊕ IP54
0,980 Kg / 0,0050 m ³ LED 19W / 2150 lm	0,750 Kg / 0,0192 m ³ LED 16W / 1750 lm	0,600 Kg / 0,0143 m ³ LED 10W / 1050 lm
€ 225	€ 190	€ 155
331690 Bianco 345130 Cromo 345147 Nero	<small>new</small> 142289 Bianco <small>new</small> 142265 Cromo <small>new</small> 302232 Nero	142296 Bianco 142272 Cromo 302225 Nero



142296

142272

302225

Bow

Montatura in metallo con finitura disponibile in brunito, cromo o ottone satinato. Diffusore a LED inclinabile. Interruttore sulla base.

LED Sorgente luminosa LED 3000 K, 20.000 h di durata.

ON OFF Lampada con interruttore integrato.

■ IP20	■ IP20	■ IP20
0,860 Kg / 0,0328 m³ LED 8W / 1050 lm	0,790 Kg / 0,0207 m³ LED 4,6W / 580 lm	0,640 Kg / 0,0117 m³ LED 3,5W / 410 lm
€ 195	€ 145	€ 125
007021 Cromo 121130 Ottone 121147 Brunito	007045 Cromo 121178 Ottone 121161 Brunito	005386 Cromo 121154 Ottone 121338 Brunito



Mirror-10

Montatura in metallo con finitura in brunito, cromo o nickel satinato. Diffusore posizionabile.

LED Lampadine LED G9 3W 3000 K incluse. Cod. **209043**

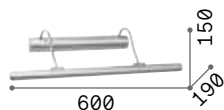

■ IP20 G9

1,090 Kg / 0,0181 m³
G9 max 4 x 40W

€ 138

017303 Cromo
017297 Nickel
017310 Brunito

3000 K
510 lm

305486 € 6,00



Retrò

Base braccio e diffusore interamente in metallo con finitura brunito. Diffusore orientabile.

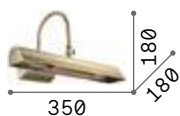

■ IP20

0,790 Kg / 0,0152 m³

E14 max 2x28W

€ 120

144917 ■ Brunito

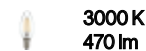

101224 € 2,00



Mirror-20

Montatura in metallo placcato. Diffusore regolabile. Colori: brunito o cromo.



Lampadine LED G9 3W 3000 K incluse.
Cod. 209043

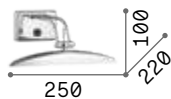

■ IP20

0,550 Kg / 0,0077 m³

G9 max 2 x 40W

€ 94

017334 ■ Cromo

017327 ■ Brunito

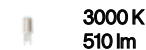

305486 € 6,00





Focus

Corpo luce in metallo con braccio flessibile orientabile rivestito in gomma. Rifinito in bianco o in nero opaco oppure in grigio con dettagli in cromo.

LED Sorgente luminosa LED 3000 K, 20.000 h di durata.

ON OFF Lampada con interruttore integrato.

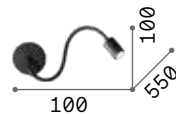

IP20

0,400 Kg / 0,0025 m³
LED 4W / 310 lm

€ 65

097183 ■ Bianco
097206 ■ Cromo
097190 ■ Nero



IP20

0,410 Kg / 0,0020 m³
LED 3,5W / 280 lm

€ 70

203171 ■ Bianco
203188 ■ Cromo
203195 ■ Nero



IO

Corpo luce da incasso con montatura in metallo verniciato a polveri. Braccio flessibile rivestito in gomma. Diffusore con schermo acrilico trasparente zigrinato. Interruttore incorporato. Colori: bianco o nero.

LED Sorgente luminosa LED 3000 K, 30.000 h di durata.

ON OFF Lampada con interruttore integrato.

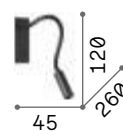

IP20

0,240 Kg / 0,0027 m³
LED 3W / 300 lm

€ 130

285320 ■ Bianco
272030 ■ Nero



Goose

Montatura e diffusore in fusione d'alluminio verniciato a polveri con colori opachi. Braccio flessibile rivestito in gomma siliconica.



Sorgente luminosa LED 3000 K, 30.000 h di durata.



Lampada con interruttore integrato.



142708



142692



IP20

0,430 Kg / 0,0040 m³
LED 3W / 190 lm

€ 145

142708 ■ Bianco
142692 ■ Nero



Dynamo

Montatura e braccio flessibile in metallo con finitura disponibile in cromo, nickel e brunito. Diffusore orientabile a piacere. Dotato di interruttore sulla base.

LED Sorgente luminosa LED 4000 K, 20.000 h di durata.

ON/OFF Lampada con interruttore integrato.



031460



031477



121352

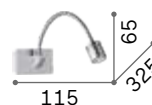

IP20

0,500 Kg / 0,0031 m³
LED 3,5W / 190 lm

€ 88

031460 Cromo
031477 Nickel
121352 Brunito



Bean

Base e diffusore orientabile in metallo placcato o verniciato a polveri. Colori bianco, nero oppure ottone o nickel con interruttore e snodo neri.

LED Sorgente luminosa LED 3000 K, 30.000 h di durata.

ON OFF Lampada con interruttore integrato.

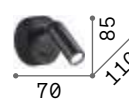
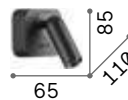

IP20

IP20

0,180 Kg / 0,0008 m³
LED 3W / 260 lm

0,180 Kg / 0,0005 m³
LED 3W / 260 lm

€ 55

€ 55

260648 Bianco
260679 Nickel
260655 Nero
260662 Ottone

260600 Bianco
260631 Nickel
260617 Nero
260624 Ottone



Page

Corpo luce in alluminio verniciato a polveri bianco o nero. Diffusore orientabile con lente e elemento snodato in metallo cromato.

LED Sorgente luminosa LED 3000 K, 30.000 h di durata.

ON OFF Lampada con interruttore integrato.

142586



142579

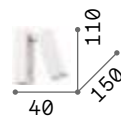
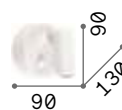

IP20

IP20

0,320 Kg / 0,0025 m³
LED 3W / 140 lm

0,420 Kg / 0,0023 m³
LED 3W / 140 lm

€ 100

€ 105

142586 ■ Bianco
142579 ■ Nero

142258 ■ Bianco
142241 ■ Nero



Pipe

Corpo luce in alluminio verniciato a polveri. Diffusore orientabile con schermo acrilico zigrinato, fissato con ghiera. Interruttore incorporato. Colori: bianco o nero.

LED

Sorgente luminosa LED 3000 K, 20.000 h di durata.

**ON
OFF**

Lampada con interruttore integrato.



280998



281001

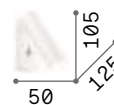

■ □ IP20

0,400 Kg / 0,0009 m³
LED 7W / 580 lm

€ 100

280998 ■ Bianco
281001 ■ Nero



ONLY BOX 502

Lite

Base e corpo luce in alluminio con finitura bianco, nero, nickel o ottone. Diffusore orientabile. Interruttore incorporato. Installazione ad incasso su scatola di derivazione tipo 502, non inclusa.

LED Sorgente luminosa LED 3000 K, 20.000 h di durata.

ON OFF Lampada con interruttore integrato.



250106



250113



250120

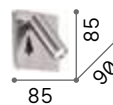

IP20

0,340 Kg / 0,0008 m³
LED 3W / 200 lm

€ 61

250106 ■ Bianco
250113 ■ Nero
250120 ■ Ottone



Bonne Nuit **new**

Montatura in metallo placcato o verniciato a polveri. Doppia sorgente: una fissa e una su cilindro orientabile. Due interruttori integrati per accensioni indipendenti. Colori: bianco, nero, ottone, nickel.

LED Sorgente luminosa LED 3000 K, 50.000 h di durata.

ON
OFF Lampada con interruttore integrato.



■ □ IP20

0,360 Kg / 0,0015 m³
LED 6,5W / 830 lm

€ 75

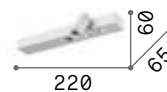

■ □ IP20

0,360 Kg / 0,0015 m³
LED 6,5W / 830 lm

€ 75

336794	Bianco	new	345499	Bianco	new
336770	Nickel	new	345482	Nickel	new
336787	Nero	new	336817	Nero	new
336800	Ottone	new	345505	Ottone	new



Komodo

Montatura in metallo verniciato a polveri. Diffusore orientabile. Interruttore e presa USB incorporati. Finiture: bianco oppure nero.

LED Sorgente luminosa LED 3000 K, 20.000 h di durata.

ON OFF Lampada con interruttore integrato.

USB Lampada con presa USB integrata.

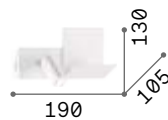

■ □ IP20

0,700 Kg / 0,0060 m³
LED 4,5W / 240 lm

€ 115

291789 ■ Bianco
291796 ■ Nero

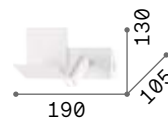

■ □ IP20

0,700 Kg / 0,0060 m³
LED 4,5W / 240 lm

€ 115

306810 ■ Bianco
306827 ■ Nero



Piano

Montatura interamente in alluminio verniciato a polveri. Diffusore in policarbonato opale con emissione sul retro. Proiettore frontale orientabile. Colore: bianco o nero.

LED Sorgente luminosa LED 3000 K, 20.000 h di durata.

ON/OFF Lampada con interruttore integrato.

USB Lampada con presa USB integrata.



287317



287300



IP20

0,800 Kg / 0,0047 m³
LED 10W / 1150 lm

€ 165

287317 ■ Bianco
287300 ■ Nero



Probe

Corpo luce in alluminio verniciato a polveri bianco o nero. Doppio diffusore: superiore in acrilico e inferiore con braccetto flessibile.

LED Sorgente luminosa LED 3000 K, 20.000 h di durata.

ON OFF Lampada con interruttore integrato.

USB Lampada con presa USB integrata.

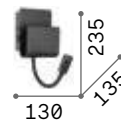

IP20

0,870 Kg / 0,0021m³
LED 9,5W / 750 lm

€ 150

243160 ■ Bianco
237930 ■ Nero



Book

Montatura metallica verniciata a polveri. Diffusore in vetro satinato. Braccio flessibile gommato con LED. Doppio interruttore. Presa USB.

LED Sorgente luminosa LED 3000 K, 15.000 h di durata.

ON/OFF Lampada con interruttore integrato.

USB Lampada con presa USB integrata.



IP20

1,570 Kg / 0,0125 m³
G9 max 1x 28W +
LED 3W / 220 lm

€ 180

174792 ■ Bianco
174808 ■ Nero

3000 K
510 lm

305486 € 6,00



IP20

1,570 Kg / 0,0125 m³
G9 max 1x 28W +
LED 3W / 220 lm

€ 180

174822 ■ Bianco
174846 ■ Nero

3000 K
510 lm

305486 € 6,00

Mouse

Base, montatura e diffusori in metallo rifinito con vernice opaca e dettagli in cromo. Diffusori orientabili. Disponibile nelle finiture bianco o nero.

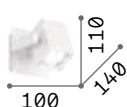
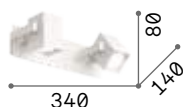

0,910 Kg / 0,0067 m³
GU10 max 2x 50W

€ 127

073545 ■ Bianco
156705 ■ Nero

0,450 Kg / 0,0034 m³
GU10 max 1x 50W

€ 72

073521 ■ Bianco
073569 ■ Nero

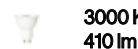

108292 € 3,00

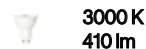

108292 € 3,00



P. 316



P. 694

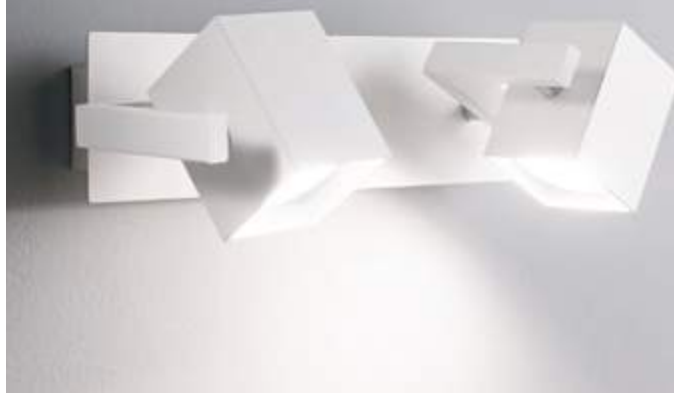

Spot

Base, montatura e diffusori in metallo rifinito con vernice opaca e dettagli in cromo. Diffusori orientabili. Disponibile nelle finiture bianco o nero.

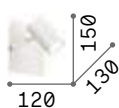
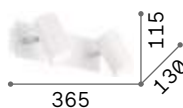

0,610 Kg / 0,0060 m³
GU10 max 2x 28W

€ 52

156736 ■ Bianco
156743 ■ Nero

0,410 Kg / 0,0037 m³
GU10 max 1x 28W

€ 32

156729 ■ Bianco
115481 ■ Nero



108292 € 3,00

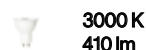

108292 € 3,00



P. 316



P. 694





Rudy

Montatura in alluminio pressofuso verniciata a polveri bianco o nero. Diffusori orientabili in rotazione e inclinazione.

LED Lampadine LED GU10 7W 3000 K incluse. Cod. **123943**

0,570 Kg / 0,0046 m ³ GU10 max 2 x 35W	0,270 Kg / 0,0017 m ³ GU10 max 1 x 35W	0,570 Kg / 0,0046 m ³ GU10 max 2 x 35W	0,270 Kg / 0,0017 m ³ GU10 max 1 x 35W
€ 100	€ 50	€ 105	€ 55
229041 ■ Bianco 229034 ■ Nero	229027 ■ Bianco 229010 ■ Nero	294803 ■ Bianco 321509 ■ Nero	294766 ■ Bianco 321530 ■ Nero
3000 K 540 lm	3000 K 540 lm	3000 K 540 lm	3000 K 540 lm
123943 € 3,50	123943 € 3,50	123943 € 3,50	123943 € 3,50

Gim

Montatura in alluminio verniciato a polveri. Diffusore ruotabile con schermo acrilico satinato. Interruttore incorporato. LED integrati.

LED Sorgente luminosa LED 3000 K, 15.000 h di durata.

ON OFF Lampada con interruttore integrato.



■ IP20

0,450 Kg / 0,0034 m³

LED 6,5W / 480 lm

€ 80

167152 ■ Bianco

167121 ■ Nero



167152

167121

Dodo

Base e corpo luce in metallo verniciato a polveri o placcato. Diffusore orientabile con sorgente a led sostituibile. Finiture: bianco, nero, ottone spazzolato.

LED Lampadine LED GX53 9W 3000 K incluse. Cod. **123936**

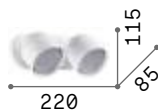

■ IP20 INCLUSA

0,930 Kg / 0,0035 m³

GX53 max 2 x 15W

€ 68

314136 ■ Bianco

327938 ■ Nero

327921 ■ Ottone

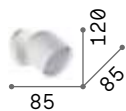

■ IP20 INCLUSA

0,450 Kg / 0,0015 m³

GX53 max 1 x 15W

€ 36

314105 ■ Bianco

314099 ■ Nero

314129 ■ Ottone

3000 K
910 lm

123936 € 5,00

3000 K
910 lm

123936 € 5,00



314105

314129

314099

Oby

Montatura in metallo verniciato bianco opaco, con snodi cromati. Corpo luce orientabile con diffusore in materiale plastico bianco.

LED Sorgente luminosa LED 3000 K, 20.000 h di durata.

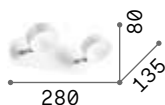

IP20

0,620 Kg / 0,0030 m³
LED 12W / 1400 lm

€ 120

196695 Bianco

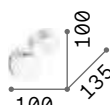

IP20

0,310 Kg / 0,0020 m³
LED 6W / 700 lm

€ 61

196688 Bianco



P. 317

Barber

Base, snodo e copri portalampade interamente in metallo. Corpo luce inclinabile. Disponibile nella versione brunito.

LED Lampadine LED GU10 7W 3000 K incluse. Cod. **123943**

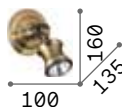

IP20

0,230 Kg / 0,0025 m³
GU10 max 1x28W

€ 75

159997 Brunito

3000 K
540 lm

123943 € 3,50



Winery

Corpo luce con portalampane incorporato interamente in ceramica smaltata bianca o nera. Modello AP con assetto inclinato verso il basso.

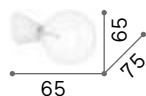

0,250 Kg / 0,0004 m³
E27 max 1x 60W

€ 30

180298 ■ Bianco
180304 ■ Nero

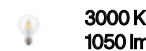

101323 € 4,50 [P. 315](#)



Edison

Montatura in metallo rifinito con vernice opaca bianca o nera. Cavo elettrico in tessuto. Diffusore orientabile.

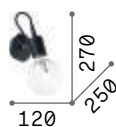

0,410 Kg / 0,0134 m³
E27 max 1x 42W

€ 65

138374 ■ Bianco
148908 ■ Nero

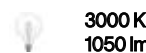

101347 € 6,00 [P. 120](#)





Radio

Rosone e montatura in metallo. Diffusore posizionabile. Cavo elettrico in tessuto. Disponibile con finitura in cromo o con vernice opaca bianca o nera.

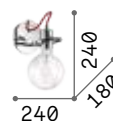

LED Lampadine LED E27 8W Globo D125 trasparente 3000 K incluse.
Cod. **101347**



IP20 

0,450 Kg / 0,0119 m³
E27 max 1x60W

€ 60

119465  Bianco
119427  Cromo
119502  Nero

 3000 K
1050 lm

101347 € 6,00



Minimal

Montatura in metallo rifinito in smalto colorato. Cavo elettrico con rivestimento in tessuto.

LED

Lampadine LED E27 8W Globo D125 trasparente 3000 K incluse.
Cod. **101347**

045191



045214

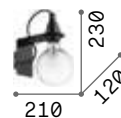

■  IP20 

0,720 Kg / 0,0164 m³
E27 max 1x60W

€ 70

045191 ■ Bianco

045214 ■ Nero

 3000 K
1020 lm

101347 € 6,00



Frida

Montatura e copri porta lampade in metallo con finiture brunito e rame. Cavo in tessuto nero.



IP20

0,430 Kg / 0,0092 m³
E27 max 1x 60W

€ 47

163338 ■ Rame
163321 ■ Brunito

2200 K
500 lm

151717 € 6,00



P. 120



Igor

Montatura in metallo rifinito con vernice opaca nera. Diffusore con lastre di vetro trasparente.

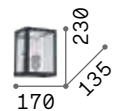

■  IP20

1,590 Kg / 0,0136 m³
E27 max 1x 42W

€ 95

092836 ■ Nero

 2200 K
440 lm

151694 € 4,00



P. 101



Birds

Montatura in metallo verniciato con disco decorativo in ottone satinato. Diffusori in vetro soffiato bianco acidato. Colore: nero opaco con dettaglio ottone satinato.

LED Lampadine LED G9 3W 3000 K incluse.
Cod. **209043**



0,670 Kg / 0,0192 m³
G9 max 1x 15W

€ **73**

273655 ■ Nero

3000 K
510 lm

305486 € **6,00**



P. 105 P. 327 P. 473 P. 497



Kepler

Montatura in metallo verniciato
nero opaco. Diffusori in vetro
soffiato trasparente ambrato.



■ □ IP20

0,900 Kg / 0,0428 m³
E27 max 3 x 42W

€ 150

187006 ■ Nero

■ 3000 K
430 lm

101279 € 2,00



P. 111



Perlage

Montatura in metallo. Finiture: nero opaco con vetri pirex fumé o ottone satinato con vetri bianchi acidati.



Lampadine LED G9 3W 3000 K incluse.
Cod. **209043**



0,800 Kg / 0,0173 m³
G9 max 3 x 15W

€ 175

283784 ■ Bianco
271439 ■ Fumè
322742 ■ Ambra

3000 K
510 lm

305486 € 6,00

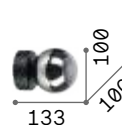

0,400 Kg / 0,0062 m³
G9 max 1 x 15W

€ 75

292410 ■ Bianco
292403 ■ Fumè
317809 ■ Ambra

3000 K
510 lm

305486 € 6,00



P. 106



P. 324



P. 473



P. 498

Triumph

Base, bracci e copri porta lampade in metallo placcato. Colore: ottone invecchiato.



Lampada con interruttore integrato.

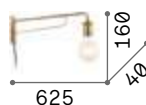
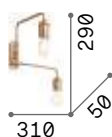

0,710 Kg / 0,0067 m³
E27 max 2x42W

0,490 Kg / 0,0083 m³
E27 max 1x42W

€ 160

€ 105

160245 Ottone

160214 Ottone



2200 K
370 lm



2200 K
370 lm

151687 € 2,50

151687 € 2,50



P. 098 P. 326

Maracas

Base e corpo luce in metallo placcato. Diffusori orientabili in vetro borosilicato soffiato trasparente. Colore: ottone satinato.



Lampadine LED G4 2W 3000 K incluse.
Cod. 222257



0,280 Kg / 0,0034 m³
G4 max 1x2W

€ 72

200330 Ottone



3000 K
200 lm



222257 € 4,00

P. 330



Equinoxe ^{new}

Montatura in metallo placcato.
Diffusori in vetro borosilicato
trasparente. Colori: montatura
cromo con vetro trasparente o fumè
sfumato, montatura ottone antico
con vetro trasparente o ambra
sfumato.



Lampadine LED G4 2W 3000 K incluse.
Cod. 222257



P. 108



P. 499

Cantina

Montatura, diffusore e copriportalampada in metallo disponibile con finitura brunito o rame. Cavo in tessuto.

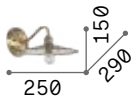

■  IP20

0,520 Kg / 0,0184 m³

E14 max 1x40W

€ 90

112695 ■ Rame

112626 ■ Brunito



3000 K
480 lm



101200

€ 2,00

[P. 137](#)



112695

112626

Newton

Montatura e diffusore in metallo. Disponibile con finitura in nickel satinato, brunito o con vernice nera opaca. Braccio regolabile. Diffusore orientabile smaltato bianco all'interno.

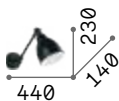

■  IP20

0,600 Kg / 0,0093 m³

E27 max 1x42W

€ 62

016399 ■ Nickel

027852 ■ Nero

027876 ■ Brunito



3000 K
900 lm



123899

€ 3,50

[P. 516](#)



016399



027852



027876



Shower

Montatura in metallo verniciato opaco nero. Elemento snodato in cromo. Diffusore orientabile. Cavo in tessuto con interruttore e spina.



Lampada con interruttore integrato.



IP20

0,760 Kg / 0,0391 m³
E27 max 1x60W

€ 130

179643 ■ Nero

3000 K
900 lm

123899 € 3,50



Ping Pong

Montatura in metallo verniciato a polveri o placcato. Diffusore a sfera in acrilico satinato. Modello con diffusore cilindrico orientabile, con accensioni indipendenti. Colori: bianco, nero, ottone spazzolato.



LED Sorgente luminosa LED 3000 K, 50.000 h di durata.

ON OFF Lampada con interruttore integrato. Cod. **336534, 336664, 336671**

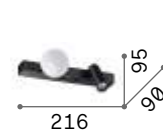

■ □ IP20

0,680 Kg / 0,0025 m³
LED 6W / 600 lm

€ 110

336534 ■ Bianco new 328270 ■ Bianco
336664 ■ Nero new 313252 ■ Nero
336671 ■ Ottone new 328287 ■ Ottone

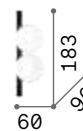

■ □ IP20

0,540 Kg / 0,0021 m³
LED 6W / 500 lm

€ 100

 P. 336  P. 472  P. 505



Binomio

Montatura in metallo. Diffusori in vetro soffiato bianco acidato con fissaggio a vite. Finiture: bianco, nero, ottone spazzolato.



Lampadine LED G9 3W 3000 K incluse.
Cod. 209043



0,500 Kg / 0,0081 m³
G9 max 1x 4W

€ 55

328478 Bianco
310664 Nero
311319 Ottone

3000 K
510 lm

305486 € 6,00



P. 337



Pan

Diffusore con tubi decorativi di diverse misure in metallo placcato. Emissione luce sopra e sotto.

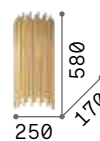

■  IP20

6,340 Kg / 0,0461 m³
E14 max 2x 40W

€ 450

208794  Oro

 3000 K
470 lm

101224 € 2,00



P. 191

Penta

Montatura in metallo. Diffusori in vetro soffiato bianco acidato con fissaggio a vite. Finiture: oro spazzolato.

LED Lampadine LED G9 3W 3000 K incluse.
Cod. **209043**

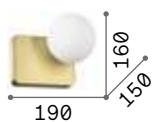

0,600 Kg / 0,0060 m³

G9 max 1x 4W

€ 60

314334 **Oro**



305486

€ 6,00

P. 340



Ninfea

Base in metallo verniciato a polveri o placcato. Diffusori in vetro incamiciato bianco, soffiato e acidato. Colori: bianco o ottone satinato.

LED Lampadine LED GX53 9W 3000 K incluse. Cod. **123936**

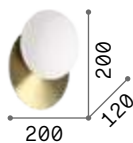
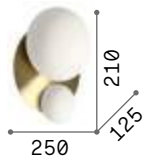

0,800 Kg / 0,0063 m³

G9 max 2 x 4W

€ 132

327716 **Bianco**

new

306940 **Bianco**

346533 **Ottone**

new

293646 **Ottone**



305486

€ 6,00



123936

€ 5,00



P. 339



P. 471





Tick

Corpo luce in metallo verniciato a polveri bianco o rifinito in foglia oro o argento. Diffusore inclinabile di 90°.

LED Sorgente luminosa LED 3000 K, 30.000 h di durata.



238951



238975



238944

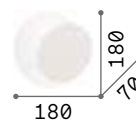

■ □ IP20

0,440 Kg / 0,0029 m³
LED 7,5W / 700 lm

€ 70

238975 ■ Bianco
238951 ■ Argento
238944 ■ Oro



Eclissi

Montatura in metallo rifinito con vernice a polveri e foglia oro. Il posizionamento variabile del diffusore superiore, consente una rifrazione luminosa più bianca o più dorata.

LED Sorgente luminosa LED 3000 K, 17.500 h di durata.

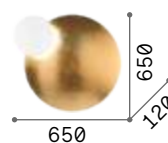

■ □ IP20

5,600 Kg / 0,0615 m³
LED 30W / 2550 lm

€ 380

259062 ■ Oro

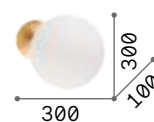

■ □ IP20

1,400 Kg / 0,0131 m³
LED 11W / 950 lm

€ 115

259048 ■ Oro



P. 192 P. 292 P. 482 P. 530

Set up new

Montatura in metallo verniciato a polveri o placcato. Versione a due luci con braccio flessibile rivestito in gomma e interruttori indipendenti. Paralumi in pvc ignifugo rivestito di tessuto. Colori montature: bianco, nero, nichel satinato o ottone spazzolato con dettagli neri. Colori paralumi: beige, bianco, nero, tortora, legno.



LED

Sorgente luminosa LED 3000 K nel modello **259819, 259826, 259833** e **259857**, 20.000 h di durata.

**ON
OFF**

Lampada con interruttore integrato nei modelli: **259819, 259826, 259833** e **259857**.



259765

259796

259772

259802

260068

304113

260075

260082

345956

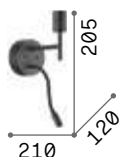

IP20

0,900 Kg / 0,0063 m³
E27 max 1x 42W +
LED 3W / 200 lm

€ 133

259819 Bianco
259833 Nickel
259826 Nero
259857 Ottone

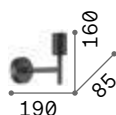

IP20

0,370 Kg / 0,0032 m³
E27 max 1x 42W

€ 63

259765 Bianco
259796 Nickel
259772 Nero
259802 Ottone

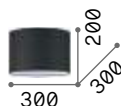

0,460 Kg / 0,0228 m³

€ 63

260433 Bianco
304618 Tortora
270005 Nero
260440 Beige
345888 Legno



0,120 Kg / 0,0180 m³

€ 32

260327 Bianco
304601 Tortora
269986 Nero
260334 Beige
345871 Legno

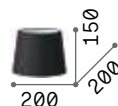

0,130 Kg / 0,0180 m³

€ 34

260068 Bianco
304113 Tortora
260075 Nero
260082 Beige
345956 Legno



0,110 Kg / 0,0180 m³

€ 29

260341 Bianco
293004 Tortora
270036 Nero
260358 Beige
345949 Legno



3000 K
900 lm

123899 € 3,50



3000 K
900 lm

123899 € 3,50

Nordik

Montatura in metallo verniciato nero opaco. Interruttore unico con controllo indipendente delle due sorgenti luminose.

LED Sorgente luminosa LED 3000 K, 20.000 h di durata.

IP20

0,630 Kg / 0,0156 m³
E14 max 1x40W +
LED 1,5W/130 lm

€ 110

158242 ■ Nero

3000 K
480 lm

101200

€ 2,00



P. 189

P. 480

P. 532



Gea

Corpo luce in alluminio verniciato a polveri bianco o nero. Diffusore con led integrato orientabile. Paralume in pvc rivestito di tessuto. Presa USB. Interruttori indipendenti.

LED Sorgente luminosa LED 3000 K, 20.000 h di durata.

ON OFF Lampada con interruttore integrato.

USB Lampada con presa USB integrata.

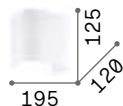
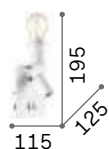

IP20

0,500 Kg / 0,0022 m³
E27 max 1x60W +
LED 3W/230 lm

€ 125

239521 ■ Bianco
239545 ■ Nero

0,140 Kg / 0,0180 m³

€ 17

239576 ■ Bianco
239590 ■ Nero
239606 ■ Canvas

3000 K
900 lm

123899

€ 3,50





Hotel

Paralume in tessuto con vetri satinati. Modello a doppia luce con sorgente esterna orientabile e accensioni indipendenti. Colori: tutto bianco, tutto nero, montatura cromo con paralume bianco, canvas o nero.

LED Sorgente luminosa LED 3000 K, 20.000 h di durata.

ON OFF Lampada con interruttore integrato.

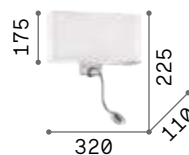

IP20

1,410 Kg / 0,0166 m³
E27 max 1x60W +
LED 1,5W / 50 lm

€ 125

215693 Total White
035949 Bianco
215709 Total Black
035956 Nero
103204 Canvas

3000 K
900 lm
123899 € 3,50

Roma

Montatura e dettagli in metallo cromato. Diffusore con elementi quadrati in cristallo molato sulla fascia laterale e vetro sabbiato sul fondo.

LED Lampadine LED G9 3W 3000 K incluse.
Cod. **209043**

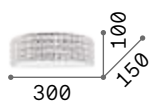

1,200 Kg / 0,0147 m³
G9 max 2x40W

€ 175

093086 Cromo

3000 K / 510 Lm
305486 € 6,00



P. 344



P. 486

Pashà

Montatura in metallo. Diffusore composto da filari di perle in cristallo molato.

LED Lampadine LED G9 3W 3000 K incluse.
Cod. **209043**

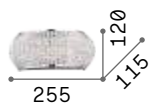

1,110 Kg / 0,0057 m³
G9 max 3x40W

€ 210

082264 Cromo
082288 Oro

3000 K / 510 Lm
305486 € 6,00



P. 205



P. 345



082264



082288

Carlton

Montatura in metallo cromato o dorato. Elementi decorativi con catene di ottagononi e barre in cristallo molato trasparente.

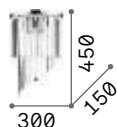

IP20

2,570 Kg / 0,0154 m³

E14 max 3x 40W

€ 170

168913 Cromo

213491 Oro

101224 3000 K
470 lm

€ 2,00

P. 203

P. 355



168913



213491

Dubai

Montatura in metallo con finitura cromo o ottone. Elementi decorativi con perle, ottagononi e prismi in cristallo molato trasparente.



IP20

1,190 Kg / 0,0084 m³

E14 max 2x 28W

€ 210

207155 Cromo

201023 Ottone

101224 3000 K
470 lm

€ 2,00

P. 208

P. 353



207155



201023

Opera

Montatura in cromo. Paralume in lamina di PVC con riflessi metallizzati e rivestita da fili. Pendagli in cristallo molato.



Sorgente luminosa LED 3000 K,
15.000 h di durata.



Lampada con interruttore integrato.



IP20

1,550 Kg / 0,0220 m³

E14 max 1x40W +
LED 1,5W / 50 Lm

€ 180

068268 Bianco



3000 K
420 Lm



P. 198



P. 486



P. 534

101217

€ 2,00

Swan

Montatura in cromo. Corpo luce in vetro soffiato e lavorato a mano. Elementi decorativi in cristallo molato. Paralume in tessuto d'organza plissettato.

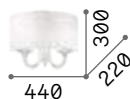

IP20

2,470 Kg / 0,0517 m³

E14 max 2x40W

€ 210

035864 Bianco



3000 K
420 Lm



P. 199

101217

€ 2,00

Corte

Montatura completamente in metallo modellato con lavorazione artigianale. Finitura dipinta a mano con effetto antichizzato. Disponibile nella versione bianca o ruggine.

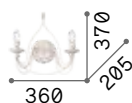

IP20

1,060 Kg / 0,0329 m³

E14 max 2 x 40W

€ 90

028460 **Bianco**
057200 **Ruggine**

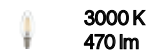

101224 € 2,00

P. 215



Pegaso

Montatura in metallo cromato oppure ottone satinato. Corpo centrale, bobeches e pendagli in cristallo molato. Paralumi in organza.

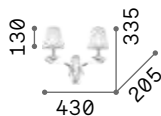

IP20

1,600 Kg / 0,0302 m³

E14 max 2 x 28W

€ 165

059211 **Bianco**
197708 **Ottone**

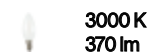

101231 € 2,00

P. 212

P. 489



Negresco

Montatura e dettagli in metallo placcato. Bracci in vetro soffiato trasparente con interno dorato. Elementi decorativi in vetro trasparente e cristallo molato. Colore: oro.

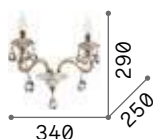

■  IP20

2,380 Kg / 0,0189 m³

E14 max 2x28W

€ 160

087757  Oro

 3000 K
430 lm



101248 € 2,00 [P. 218](#)

Florian

Montatura in metallo con elementi decorativi in vetro. Pendagli con ottagoni e gocce finali in cristallo molato. Disponibile nelle versioni con vetro trasparente e metallo dorato o cromato.

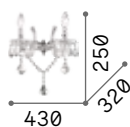



■  IP20

1,430 Kg / 0,0189 m³

E14 max 2x40W

€ 155

035642  Cromo
035659  Oro

 3000 K
470 lm



101224 € 2,00 [P. 220](#)



035642



035659

Gioconda

Corpo luce in fusione di metallo con finitura oro o argento antico. Pendagli ottagonali e tondi in cristallo molato.



IP20

1,310 Kg / 0,0111 m³

E14 max 2 x 40W

€ 215

044910 Argento

060491 Oro



3000 K
470 lm



101224

€ 2,00

P. 224



044910



060491

Strauss

Montatura e dettagli in metallo con finitura oro rosa. Bracci in vetro soffiato trasparente. Elementi decorativi in cristallo ambrato.

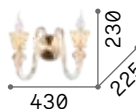

IP20

2,080 Kg / 0,0431 m³

E14 max 2 x 40W

€ 145

140599 Oro



3000 K
430 lm



101248

€ 2,00

P. 225

Firenze

Corpo luce in resina. Bracci e foglie in metallo modellato artigianalmente. Decorato a mano con foglia d'oro e antichizzato.

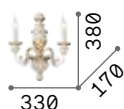

■  IP20

2,050 Kg / 0,0405 m³

E14 max 2x40W

€ 165

012902  Bianco

020846  Oro

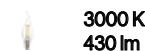

101248 € 2,00



P. 230



P. 485



P. 535



012902



020846

Chalet

Montatura con struttura portante in metallo. Elementi decorativi in resina lavorata artigianalmente e dipinta a mano come fedele riproduzione di corna e legno intagliato.

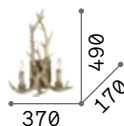

■  IP20

1,770 Kg / 0,0759 m³

E14 max 2x40W

€ 205

115511  Beige

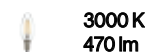

101224 € 2,00



P. 234



P. 484





Peter

Montatura in resina lavorata artigianalmente come fedele riproduzione del legno intagliato. Paralume in lamina di PVC rivestito in tessuto canvas.

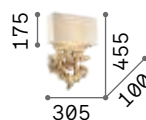

IP20

4,160 Kg / 0,0371 m³
E14 max 2 x 40W

€ 230

075211 Canvas



3000 K
480 lm

101200 € 2,00



Harem

Montatura in metallo brunito con decori in rilievo e cristalli incastonati. Diffusore in vetro soffiato leggermente ambrato. Pendaglio a nappa.



■ □ IP20

0,900 Kg / 0,0273 m³
E27 max 1x42W

€ 210

115962 ■ Brunito

● 3000 K
910 lm

119571 € 3,50



P. 233



Santa

Lampadario in vetro trasparente soffiato e lavorato a mano. Dettagli in metallo cromato. Versione oro disponibile con graniglia sul vetro.



087368



087375

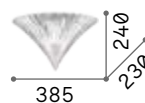

■ IP20

2,900 Kg / 0,0380 m³
E14 max 1x 40W

€ 230

087368 Trasparen.
087375 Oro

3000 K
470 lm

101224 € 2,00



■ IP20

1,200 Kg / 0,0184 m³
E14 max 1x 40W

€ 100

013060 Trasparen.
013046 Oro

3000 K
470 lm

101224 € 2,00



Lampade da tavolo

Interni

Indice alfabetico

Angolo	476	Nordik	480
Axel	478	Opera	486
Birds	473	Oz	452
Candy	469	Pegaso	489
Carta	468	Perlage	473
Chalet	484	Ping Pong	472
Diamond	466	Pivot	455
Diesis	459	Prato	474
Driftwood	484	Queen	488
Duchessa	487	Roma	486
Easy	458	Sally	463
Edo	475	Set Up	482
Filo	456	Smarties	469
Firenze	485	Wally	463
Futura	460	Yoko	457
Gru	454		
Kali	481		
Kelly	462		
Lawyer	464		
Lingotto	477		
London	479		
Lumiere	465		
Mapa	470		
Mignon	467		
Ninfea	471		











































Mignon

Pag 467

Interni

Indice icone

						
Oz 452	Gru 454	Pivot 455	Filo 456	Yoko 457	Easy 458	Diesis 459
						
Futura 460	Kelly 462	Sally 463	Wally 463	Lawyer 464	Lumiere 465	Diamond 466
						
Mignon 467	Carta 468	Smarties 469	Candy 469	Mapa 470	Ninfea 471	Ping Pong 472
						
Birds 473	Perlage 473	Prato 474	Edo 475	Angolo 476	Lingotto 477	Axel 478
						
London 479	Nordik 480	Kali 481	Set Up 482	Driftwood 484	Chalet 484	Firenze 485
						
Roma 486	Opera 486	Duchessa 487	Queen 488	Pegaso 489		

Oz new

Base e montatura in metallo verniciato a polveri o placcato. Cavi in pvc. Diffusore in gomma opale. Disponibile nelle finiture bianco, nero o ottone spazzolato.

LED Sorgente luminosa LED 2700 / 3000 / 4000 K, 30.000 h di durata.

ON OFF Lampada con interruttore integrato.

Sorgente	LED SMD	Durata LED	30.000 h
Potenza	22W	Classe	II
Driver incluso	On/Off	isolamento	
Driver disponibili	No	IP	20
CCT	2700 K / 3000 K / 4000 K	Materiale	Alluminio
CRI	≥90		

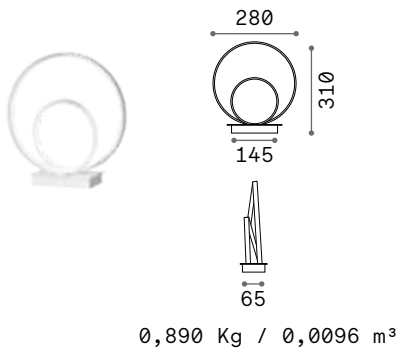

LED SMD Driver incluso

Potenza	Driver	Lumen	CCT	Finitura	Codice	€
22 W	On-Off	2500 lm	2700 K	Bianco	342467	140 <small>new</small>
				Nero	342474	140 <small>new</small>
				Ottone	342481	140 <small>new</small>
		2600 lm	3000 K	Bianco	269474	140
				Nero	269481	140
				Ottone	269498	140
		2800 lm	4000 K	Bianco	342498	140 <small>new</small>
				Nero	342504	140 <small>new</small>
				Ottone	342511	140 <small>new</small>



269474



269481



269498



Gru

Montatura interamente in metallo. Asta con finitura in cromo. Base e diffusore con finitura in vernice opaca bianca o nera. Diffusore ruotabile e regolabile in altezza.

LED Sorgente luminosa LED 3000 K, 15.000 h di durata.

ON OFF Lampada con interruttore integrato.



147642



147659

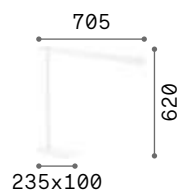

IP20

2,220 Kg / 0,0084 m³
LED 7W / 400 lm

€ 185

147642 ■ Bianco
147659 ■ Nero



Pivot

Montatura in alluminio verniciato opaco. Base rivestita in plastica con dimmer. Diffusore orientabile con schermo in PC opale satinato. Cavo in PVC con driver e spina.

LED Sorgente luminosa LED. CCT regolabile: 3000, 4000, 6500 K. 25.000 h di durata.

ON/OFF Lampada con interruttore integrato.

+ Lampada con dimmer.

☞ Lampada con dimmer tattile.

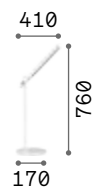

IP20 **☞** **+**

0,700 Kg / 0,0135 m³
LED 7W / 1150 lm

€ 85

289168 **Bianco**
289151 **Nero**



Filo

Base in metallo, corpo luce in alluminio verniciati a polvere o placcati. Diffusore in policarbonato opale opaco. Cavo in pvc con interruttore e driver integrato nella spina. Finiture: bianco, nero, ottone spazzolato.



Sorgente luminosa LED 3000 K, 20.000 h di durata.



Lampada con interruttore integrato.



IP20

0,500 Kg / 0,0093 m³
LED 10W / 1100 lm

€ 150

310107 ■ Bianco
310114 ■ Nero
310121 ■ Ottone



P. 084 P. 392 P. 502



Yoko

Base e montatura in metallo verniciato opaco. Diffusore in policarbonato opale. Cavo in pvc con presa-alimentatore. Colori: bianco o nero.

LED Sorgente luminosa LED 3000 K, 30.000 h di durata.

ON/OFF Lampada con interruttore integrato.

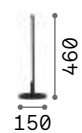

IP20

0,860 Kg / 0,0247 m³
LED 5W / 500 lm

€ 85

258881 ■ Bianco
258911 ■ Nero



P. 089



P. 503



Easy

Montatura in metallo verniciato opaco o placcato. Diffusore orientabile con ottica in acrilico satinato. Cavo in pvc con interruttore e driver integrato sulla spina. Finiture: bianco, nero, ottone spazzolato.

LED Sorgente luminosa LED 3000 K, 50.000 h di durata.

ON OFF Lampada con interruttore integrato.



P. 511



295510

295534

295541



IP20

1,200 Kg / 0,0193 m³
LED 3,5W / 420 lm

€ 90

295510 ■ Bianco
295534 ■ Nero
295541 ■ Ottone



Diesis

Montatura in metallo verniciato a polveri o placcato. Diffusore orientabile in rotazione e inclinazione. Cavo in pvc con interruttore. Colori: nero, nickel satinato oppure ottone satinato.

LED Sorgente luminosa LED 3000 K, 30.000 h di durata.

 Lampada con dimmer.

 Lampada con dimmer tattile.

 
P. 126 P. 511



291093



283333



291109

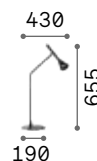

 IP20  

1,700 Kg / 0,0637 m³
LED 6,5W / 500 lm

€ 150

291093  Nickel
283333  Nero
291109  Ottone



Futura

Braccio in alluminio e plastica, snodato con cavo a vista in pvc. Diffusore orientabile a led e interruttore incorporato. Spina con alimentatore.



LED Sorgente luminosa LED 4000 K, 25.000 h di durata.

ON/OFF Lampada con interruttore integrato.

+ Lampada con dimmer.

Hand icon Lampada con dimmer tattile.



■ □ IP20 **Hand icon** **+**

1,830 Kg / 0,0069 m³
LED 12,5W / 1050 lm

€ 150

272078 ■ Bianco
204895 ■ Alluminio
204888 ■ Nero





Kelly

Lampada tecnica in metallo con
finitura bianco o nero opaco.
Braccio snodato e bilanciato a molle.
Diffusore orientabile.



Lampada con interruttore integrato.



108117

108094



IP20

1,510 Kg / 0,0065 m³
E27 max 1x 42W

€ 45

108117 ■ Bianco
108094 ■ Nero

3000 K
340 lm

101286 € 2,00

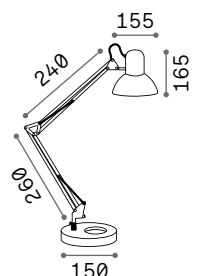



Sally

Lampada tecnica in metallo con finitura bianco, nero opaco oppure nero con snodi in rame. Braccio snodato e bilanciato a molle. Diffusore orientabile.



Lampada con interruttore integrato.



■ □ IP20

193946

265285

061160

2,600 Kg / 0,0132 m³
E27 max 1x 42W

€ 85

193946 ■ Bianco
265285 ■ Nero
061160 ■ Nero Rame

123899 3000 K
900 lm
€ 3,50

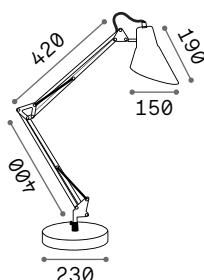

Wally

Lampada tecnica in metallo con finitura bianco, nero opaco oppure nero con snodi in rame. Braccio snodato e bilanciato a molle. Diffusore orientabile.



Lampada con interruttore integrato.



■ □ IP20

193991

265278

061191

2,450 Kg / 0,0111 m³
E27 max 1x 42W

€ 95

193991 ■ Bianco
265278 ■ Nero
061191 ■ Nero Rame

101286 3000 K
340 lm
€ 2,00

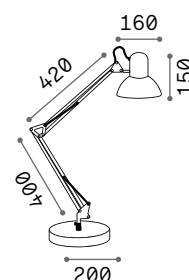

P. 517



Lawyer

Montatura in metallo con finitura disponibile in ottone, in cromo o in brunito. Diffusore in vetro soffiato e incamiciato.



Lampada con interruttore integrato.



IP20

1,850 Kg / 0,0373 m³
E27 max 1x60W

€ 120

045047 Cromo
013657 Ottone
045030 Brunito

3000 K
910 lm
119571 € 3,50





Lumiere

Montatura e rosone in metallo verniciato opaco con chiusura magnetica. Cavo in pvc trasparente. Diffusore tubolare centrale bianco. Elementi decorativi in vetro soffiato bianco lucido e trasparente grigio.

LED Sorgente luminosa LED 3000 K, 25.000 h di durata.

ON/OFF Lampada con interruttore integrato.



P. 178



P. 341



P. 496



IP20

2,800 Kg / 0,0290 m³
LED 18W / 2250 lm

€ 180

314204 Bianco



Diamond new

Lampada da tavolo a batteria ricaricabile. Diffusore in acrilico trasparente con lavorazione ad effetto cristallo molato. Interruttore tattile integrato.



LED Sorgente luminosa LED 3000 K, 20.000 h di durata.

ON OFF Lampada con interruttore integrato.

Hand icon Lampada con dimmer tattile.



P. 102

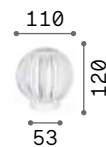

IP20

0,800 Kg / 0,0041 m³
LED 2W / 240 lm

€ 90

343488 Trasparen.new

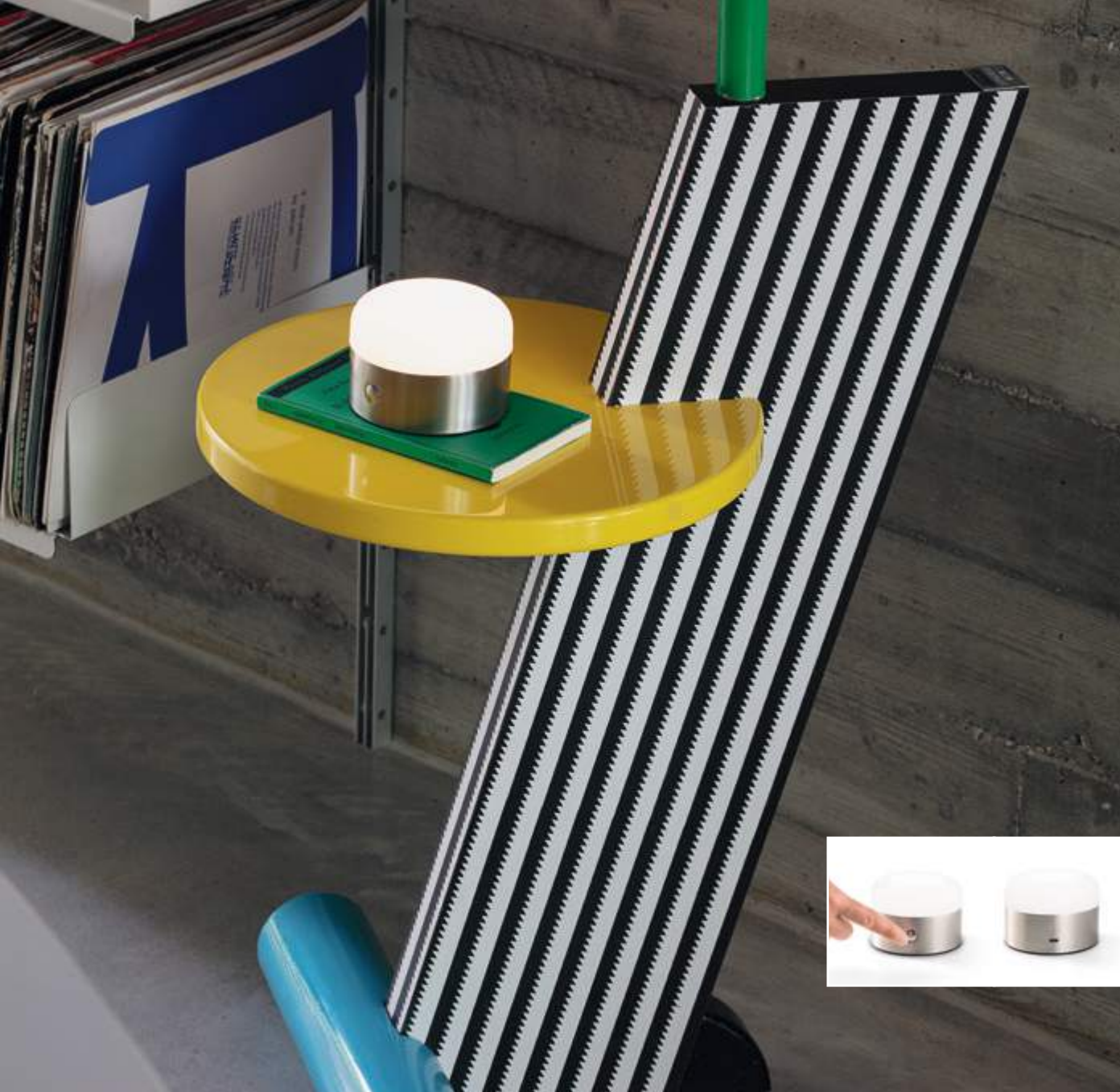

Mignon ^{new}

Lampada portatile a batteria, ricaricabile. Base in metallo verniciato a polveri o placcato. Diffusore in acrilico opale satinato. Interruttore con dimmer. Colori: bianco, nero, coffee, ottone, nickel e rame.

LED Sorgente luminosa LED 3000 K, 30.000 h di durata.

ON OFF Lampada con interruttore integrato.

Hand icon Lampada con dimmer tattile.



334998



335001



334974



335018



334981



335025



0,360 Kg / 0,0012 m³
LED 5W / 460 lm

€ 40

334998	Bianco	new
335001	Nickel	new
334974	Nero	new
335018	Coffee	new
334981	Ottone	new
335025	Rame	new



Carta

Montatura in metallo verniciato bianco opaco. Diffusore in policarbonato con rivestimento ad effetto carta.



LED Lampadine LED G9 3W 3000 K incluse nel modello **317151**. Cod. **209043**

ON/OFF Lampada con interruttore integrato.



IP20

0,950 Kg / 0,0127 m³
E27 max 1x 25W

€ 80

317168 Bianco

3000 K
430 lm

101279 € 2,00



IP20

0,400 Kg / 0,0025 m³
G9 max 1x 15W

€ 60

317151 Bianco

3000 K
510 Lm

305486 € 6,00



P. 170 P. 282 P. 385 P. 519

Smarties

Base in metallo. Diffusore in vetro soffiato acidato. Cavo elettrico con spina e interruttore.

LED Lampadine LED G9 3W 3000 K incluse nel modello **032078**. Cod. **209043**

ON/OFF Lampada con interruttore integrato.

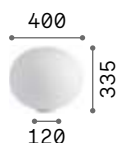

IP20

2,600 Kg / 0,0810 m³
E27 max 1x 42W

€ 190

327914 Bianco

101279 3000 K
430 lm

€ 2,00

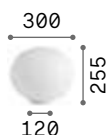

IP20

1,400 Kg / 0,0392 m³
E27 max 1x 42W

€ 130

327907 Bianco

101279 3000 K
430 lm

€ 2,00

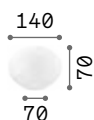

IP20

0,470 Kg / 0,0079 m³
G9 max 1x 15W

€ 50

032078 Bianco

305486 3000 K
510 Lm

€ 6,00



P. 154 P. 277 P. 385

Candy

Montatura in metallo con finitura nickel satinato. Diffusore in vetro bianco soffiato e acidato.

LED Lampadine LED G9 3W 3000 K incluse. Cod. **209043**

ON/OFF Lampada con interruttore integrato.



IP20

1,200 Kg / 0,0287 m³
G9 max 1x 40W

€ 102

086804 Bianco

305486 3000 K
510 Lm

€ 6,00



P. 158



P. 280





Mapa

Base e sistema di fissaggio in metallo bianco. Diffusore a sfera in vetro bianco soffiato e acidato.

LED Lampadine LED G9 3W 3000 K incluse nel modello **310817**. Cod. **209043**

ON OFF Lampada con interruttore integrato.

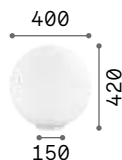

IP20

3,520 Kg / 0,1354 m³
E27 max 1x 42W

€ 165

000206 Bianco



P. 168



P. 282



P. 384

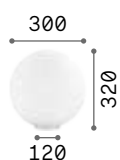

IP20

1,880 Kg / 0,0515 m³
E27 max 1x 42W

€ 85

009131 Bianco



119571



€ 3,50



IP20

1,050 Kg / 0,0214 m³
E27 max 1x 42W

€ 50

009155 Bianco



119571



€ 3,50



IP20

0,280 Kg / 0,0026 m³
G9 max 1x 4W

€ 45

310817 Bianco



305486



€ 6,00



Ninfea **new**

Base in metallo verniciato a polveri o placcato. Diffusori in vetro incamiciato bianco, soffiato e acidato. Cavo in pvc con interruttore e spina. Colori: bianco o ottone satinato.

LED Lampadine LED GX53 9W 3000 K incluse. Cod. **123936**

ON OFF Lampada con interruttore integrato.

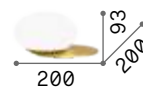

IP20

1,100 Kg / 0,0158 m³
GX53 max 1x15W

€ 99

318325 **Bianco** **new**
346526 **Ottone** **new**

3000 K
910 lm

123936 € 5,00



P. 339



P. 431



Ping Pong

Montatura in metallo rifinito con vernice a polveri. Diffusori con sfere in acrilico trasparente satinato. Driver integrato. Cavo in pvc con interruttore. Finiture: bianco, nero, ottone spazzolato.

LED Sorgente luminosa LED 3000 K, 50.000 h di durata.

ON OFF Lampada con interruttore integrato.



IP20

1,150 Kg / 0,0232 m³
LED 6W / 500 lm

€ 130

328294 Bianco
313320 Nero
328300 Ottone

 P. 336  P. 428  P. 505

Birds

Montatura in metallo verniciato con disco decorativo in ottone satinato. Diffusori in vetro soffiato bianco acidato. Cavo in pvc con interruttore e spina. Colore: nero opaco con dettaglio ottone satinato.

LED Lampadine LED G9 3W 3000 K incluse. Cod. **209043**

ON/OFF Lampada con interruttore integrato.

130x160



0,900 Kg / 0,0163 m³

G9 max 1x 15W

€ 86

273679 ■ Nero

305486 3000 K
510 lm

€ 6,00



P. 105 P. 327 P. 421 P. 497

Perlage

Montatura in metallo. Finiture: nero opaco con vetri pirex fumé o ottone satinato con vetri bianchi acidati.

LED Lampadine LED G9 3W 3000 K incluse. Cod. **209043**

ON/OFF Lampada con interruttore integrato.



2,000 Kg / 0,0227 m³

G9 max 3 x 15W

€ 200

292472 ■ Bianco

292465 ■ Fumè

322759 ■ Ambra

305486 3000 K
510 lm

€ 6,00



0,600 Kg / 0,0062 m³

G9 max 1x 15W

€ 85

292458 ■ Bianco

292441 ■ Fumè

317823 ■ Ambra

305486 3000 K
510 lm

€ 6,00



317823



292441



292458



P. 106 P. 324 P. 423 P. 498



Prato

Diffusore in vetro soffiato bianco incamiciato e acidato. Cavo elettrico con spina e interruttore.

ON
OFF Lampada con interruttore integrato.



IP20

1,380 Kg / 0,0219 m³
E27 max 1x 60W

€ 80

074702 Bianco

3000 K
340 lm

101286 € 2,00

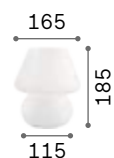

IP20

0,650 Kg / 0,0099 m³
E14 max 1x 40W

€ 51

074726 Bianco

3000 K
420 lm

101217 € 2,00



Edo

Montatura interna in metallo cromato. Diffusore in vetro bianco soffiato, incamiciato e acidato.



Lampada con interruttore integrato.



■ □ IP20

1,150 Kg / 0,0172 m³
E27 max 1x60W

€ 66

044590 Bianco

💡 3000 K
900 lm

123899 € 3,50



■ □ IP20

0,730 Kg / 0,0082 m³
E27 max 1x60W

€ 55

044606 Bianco

💡 3000 K
340 lm

101286 € 2,00



Angolo

Montatura in metallo verniciato a polveri o placcato. Diffusori in vetro bianco, soffiato e acidato. Cavo in PVC nero con interruttore e spina. Finiture: nero oppure ottone satinato.

LED Lampadine LED G9 3W 3000 K incluse. Cod. **209043**

ON OFF Lampada con interruttore integrato.



284316



284361



IP20

**0,600 Kg / 0,0063 m³
G9 max 1x28W**

€ 75

284316 ■ Nero
284361 ■ Ottone



P. 334



P. 500

**3000 K
510 lm**

305486 € 6,00



Lingotto

Montatura in metallo verniciato: base nera opaca e telaio ottone opaco oppure completamente nero opaco. Diffusori in vetro incamiciato bianco, soffiato e acidato.

LED Lampadine LED G9 3W 3000 K incluse nei modelli: **304151** e **259222**.
Cod. **209043**

ON OFF Lampada con interruttore integrato.



259222



304151



185

220



1,320 Kg / 0,0199 m³
E14 max 1x 28W

€ 125

327877 ■ Nero
251127 ■ Ottone

3000 K
420 lm

101217 € 2,00



120

150



0,750 Kg / 0,0084 m³
G9 max 1x 4W

€ 90

304151 ■ Nero
259222 ■ Ottone

3000 K
510 lm

305486 € 6,00



P. 100



P. 335



Axel

Base e raccordi in metallo verniciato a polveri. Stelo in legno naturale. Paralume regolabile in altezza, in pvc rivestito di tessuto. Cavo in pvc con interruttore. Colori: bianco o nero.



Lampada con interruttore integrato.

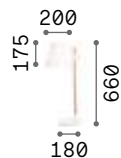

IP20

1,970 Kg / 0,0183 m³
E27 max 1x 60W

€ 140

282091 ■ Bianco
272238 ■ Nero

3000 K
910 lm

119571 € 3,50



P. 526



London

Montatura in metallo rifinito in cromo o con vernice opaca bianca o nera. Paralume in lamina di PVC rivestito di tessuto, per la versione cromo in lamina di PVC cromata e semi trasparente.



Lampada con interruttore integrato.



110530



032368



110554

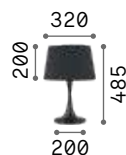

IP20

1,910 Kg / 0,0645 m³
E27 max 1x60W

€ 110

110448 ■ Bianco
032375 ■ Cromo
110455 ■ Nero

3000 K
910 lm

119571 € 3,50



IP20

1,270 Kg / 0,0253 m³
E27 max 1x60W

€ 80

110530 ■ Bianco
032368 ■ Cromo
110554 ■ Nero

3000 K
910 lm

119571 € 3,50



P. 529



Nordik

Montatura in metallo verniciato nero opaco. Paralume in lamina di PVC dorato rivestito in tessuto nero.



Lampada con interruttore integrato.

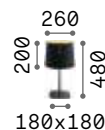

1,220 Kg / 0,0504 m³
E27 max 1x60W

€ 115

161686 ■ Nero

3000 K
910 lm

119571 € 3,50



P. 189 P. 436 P. 532



Kali

Corpo luce in ceramica con decori in rilievo. Paralume in pvc rivestito con tessuto. Cavo in pvc con interruttore integrato.



Lampada con interruttore integrato.



0,660 Kg / 0,0092 m³
E14 max 1x40W

€ 28

245331 Bianco

3000 K
420 lm
101217 € 2,00



0,620 Kg / 0,0037 m³
E14 max 1x40W

€ 28

245348 Bianco

3000 K
420 lm
101217 € 2,00



0,660 Kg / 0,0055 m³
E14 max 1x40W

€ 28

245393 Bianco

3000 K
420 lm
101217 € 2,00



Set up ^{new}

Montatura in metallo verniciato a polveri o placcato. Paralumi in pvc ignifugo rivestito di tessuto. Cavo in pvc. Colori montature: bianco, nero, nichel satinato o ottone spazzolato. Colori paralumi: beige, bianco, nero, tortora, legno.



Lampada con interruttore integrato.



259918



259949



259925



259956



260068



304113



260075



260082



345956



1,130 Kg / 0,0055 m³
E27 max 1x 42W

€ 90

259918 ■ Bianco
259949 ■ Nickel
259925 ■ Nero
259956 ■ Ottone



0,680 Kg / 0,0061 m³
E27 max 1x 42W

€ 70

259864 ■ Bianco
259895 ■ Nickel
259871 ■ Nero
259901 ■ Ottone

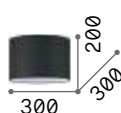

0,460 Kg / 0,0228 m³

€ 63

260433 ■ Bianco
304618 ■ Tortora
270005 ■ Nero
260440 ■ Beige
345888 ■ Legno

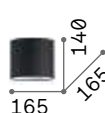

0,120 Kg / 0,0180 m³

€ 32

260327 ■ Bianco
304601 ■ Tortora
269986 ■ Nero
260334 ■ Beige
345871 ■ Legno



0,130 Kg / 0,0180 m³

€ 34

260068 ■ Bianco
304113 ■ Tortora
260075 ■ Nero
260082 ■ Beige
345956 ■ Legno



0,110 Kg / 0,0180 m³

€ 29

260341 ■ Bianco
293004 ■ Tortora
270036 ■ Nero
260358 ■ Beige
345949 ■ Legno



3000 K
900 lm

123899 € 3,50



3000 K
900 lm

123899 € 3,50

Driftwood

Montatura in metallo. Elementi decorativi con rami di legno naturale. Diffusore in lamina di pvc rivestito con tessuto canvas.



Lampada con interruttore integrato.

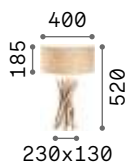

2,450 Kg / 0,0709 m³

E27 max 1x 60W

€ 220

129570 ■ Legno



2200 K
370 Lm



151687

€ 2,50

[P. 235](#)

[P. 526](#)



Chalet

Montatura con struttura portante in metallo. Elementi decorativi in resina lavorata artigianalmente e dipinta a mano come fedele riproduzione di corna e legno intagliato.



Lampada con interruttore integrato.

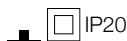
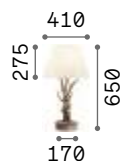

3,500 Kg / 0,1650 m³

E27 max 1x 60W

€ 280

128207 ■ Beige



3000 K
910 lm



119571

€ 3,50

[P. 234](#)

[P. 444](#)





Firenze

Corpo luce in resina. Bracci e foglie in metallo modellato artigianalmente. Decorato a mano con foglia d'oro e antichizzato.



Lampada con interruttore integrato.



012889



020853

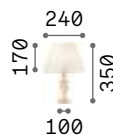

IP20

1,220 Kg / 0,0216 m³
E14 max 1x 40W

€ 140

012889 ■ Bianco
020853 ■ Oro

3000 K
480 lm

101200 € 2,00



P. 230



P. 444



P. 535

Roma

Montatura e dettagli in metallo cromato. Diffusore con elementi quadrati in cristallo molato sulla fascia laterale e vetro sabbiato sul fondo.

LED Lampadine LED G9 3W 3000 K incluse.
Cod. **209043**

ON OFF Lampada con interruttore integrato.

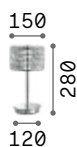

IP20

1,930 Kg / 0,0182 m³

G9 max 1x40W

€ 160

114620 Cromo

3000 K
510 lm

305486

€ 6,00

P. 344

P. 438



Opera

Montatura in cromo. Paralume in lamina di PVC con riflessi metallizzati e rivestita da fili. Pendagli in cristallo molato.

ON OFF Lampada con interruttore integrato.

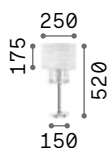

IP20

1,750 Kg / 0,0392 m³

E27 max 1x60W

€ 145

068305 Bianco

3000 K
900 lm

123899

€ 3,50

P. 198

P. 440

P. 534





Duchessa

Base e dettagli in metallo cromato.
Elementi decorativi in vetro soffiato
e lavorato a mano. Paralume in
tessuto di organza plissettato.



Lampada con interruttore integrato.

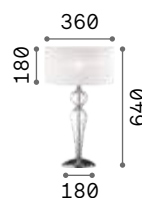

■ □ IP20

3,000 Kg / 0,0652 m³
E27 max 1x60W

€ 155

044491 ■ Trasparen.

● 3000 K
900 lm

123899 € 3,50

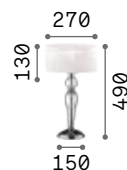

■ □ IP20

1,900 Kg / 0,0610 m³
E27 max 1x60W

€ 135

051406 ■ Trasparen.

● 3000 K
900 lm

123899 € 3,50



Queen

Montatura in metallo dorato con elementi decorativi e base in cristallo molato. Paralume in lamina di PVC, rivestita in tessuto con decorazione trapuntata e brillantini dorati.



Lampada con interruttore integrato.

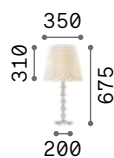

■ □ IP20

2,300 Kg / 0,0886 m³
E27 max 1x60W

€ 210

077758 ■ Oro

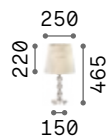

■ □ IP20

1,360 Kg / 0,0460 m³
E27 max 1x60W

€ 140

077741 ■ Oro

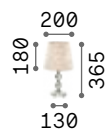

■ □ IP20

0,900 Kg / 0,0137 m³
E27 max 1x60W

€ 120

077734 ■ Oro



3000 K
910 lm

119571

€ 3,50



3000 K
910 lm

119571

€ 3,50



3000 K
910 lm

119571

€ 3,50



P. 534



Pegaso

Montatura in metallo cromato oppure ottone satinato. Corpo centrale, bobeches e pendagli in cristallo molato. Paralumi in organza.



Lampada con interruttore integrato.



059266



197753



IP20

2,000 Kg / 0,0705 m³
E27 max 1x60W

€ 215

059259 Bianco

3000 K
900 lm

123899 € 3,50



IP20

1,450 Kg / 0,0117 m³
E14 max 1x28W

€ 110

059266 Bianco
197753 Ottone

3000 K
420 lm

101217 € 2,00



P. 212



P. 441



Lampade da terra

Interni

Indice alfabetico

Angolo	500	Look	506
Axel	526	Lumiere	496
Birds	497	Mix Up	508
Carta	519	Newton	516
Colonna	533	Nordik	532
Comet	520	Opera	534
Comfort	512	Pagoda	525
Craft	510	Perlage	498
Cylinder	532	Ping Pong	505
Daddy	524	Polly	518
Diesis	511	Queen	534
Dorsale	522	Regol	528
Driftwood	526	Set Up	530
Easy	511	Wally	517
Ego	494	Yoko	503
Equinoxe	499	York	527
Eva	504		
Filo	502		
Firenze	535		
Frame	501		
Futura	514		
Ginger	515		
Klimt	527		
Lift	514		
London	529		

Interni

Indice icone

new



Ego 494



Lumiere 496



Birds 497



Perlage 498

new



Equinoxe 499



Angolo 500



Frame 501



Look 506



Mix Up 508

new



Craft 510



Easy 511



Diesis 511

new



Comfort 512



Lift 514



Polly 518



Carta 519



Comet 520



Dorsale 522



Daddy 524



Klimt 527



Regol 528



London 529



Set Up 530



Cylinder 532



Nordik 532



Colonna 533

new



Filo 502



Yoko 503



Eva 504



Ping Pong 505



Futura 514



Ginger 515

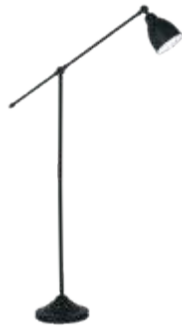

Newton 516



Wally 517



Pagoda 525



Axel 526



Driftwood 526



York 527



Opera 534



Queen 534



Firenze 535

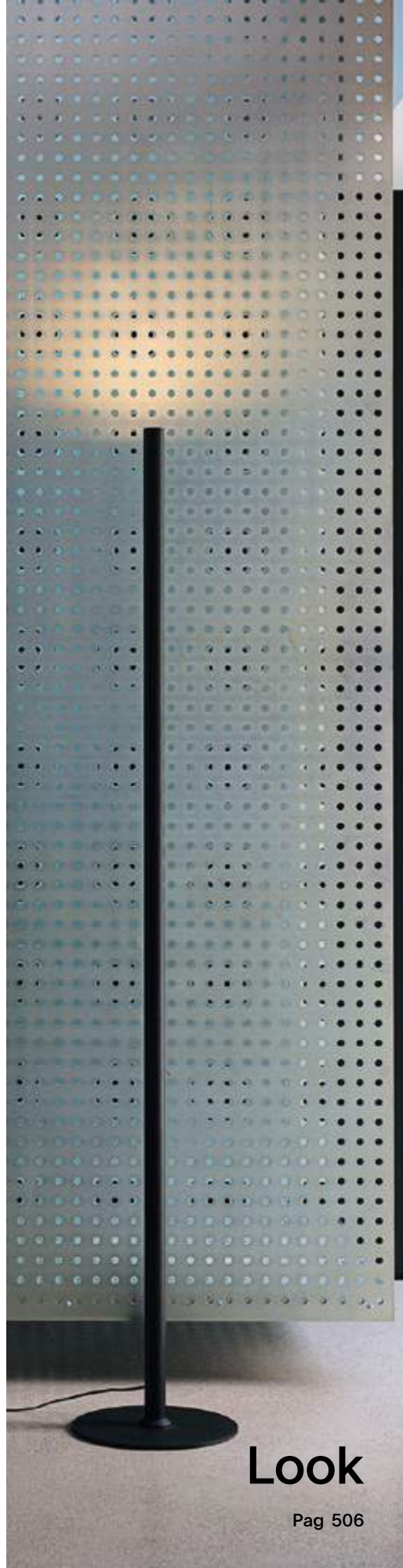

Look

Pag 506



Ego **new**

Corpo e profilo in alluminio verniciato a polveri. Sorgenti componibili con moduli luminosi della serie Ego (consumo massimo 95 W, lunghezza totale massima 1250 mm), non dimmerabili o dimmerabili 1-10 V. Dimmer incluso, integrato sul binario. Cover per profilo in plastica inclusa, tagliabile a misura. Cavo in PVC. Colore nero.

PRO Prodotto ad alto contenuto tecnologico, elevata qualità dei materiali, destinato ad uso professionale.

 Apparecchio fornito con variatore di potenza.



 IP20

10,600 Kg / 0,0259 m³

€ 300

344775 ■ Nero **new**





Lumiere

Montatura e dettagli in metallo verniciato nero opaco. Diffusore tubolare centrale bianco. Elementi decorativi in vetro soffiato bianco lucido e trasparente grigio. Cavo in pvc.

LED Sorgente luminosa LED 3000 K, 25.000 h di durata.

ON OFF Lampada con interruttore integrato.

  
 P. 178 P. 341 P. 465



 IP20

10,500 Kg / 0,1515 m³
 LED 58W / 7550 lm

€ 510

314198 Bianco



Birds

Montatura in metallo verniciato con disco decorativo in ottone satinato. Diffusori in vetro soffiato bianco acidato. Cavo in pvc con interruttore e spina. Colore: nero opaco con dettaglio ottone satinato.

LED Lampadine LED G9 3W 3000 K incluse.
Cod. **209043**

ON/OFF Lampada con interruttore integrato.



P. 105 P. 327 P. 421 P. 473

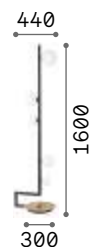

IP20 PROTEZIONE

5,640 Kg / 0,1536 m³
G9 max 5 x 15W

€ 340

273662 ■ Nero

3000 K
510 lm
305486 € 6,00



Perlage

Montatura in metallo. Diffusori in vetro soffiato. Finiture: nero opaco con vetri ambra o pirex fumé oppure ottone satinato con vetri bianchi acidati.

LED Lampadine LED G9 3W 3000 K incluse. Cod. **209043**

ON OFF Lampada con interruttore integrato.

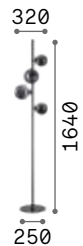

IP20

4,800 Kg / 0,0612 m³
G9 max 4 x 15W

€ 325

277967 ■ Bianco
306988 ■ Fumè
317816 ■ Ambra

3000 K
510 lm

305486 € 6,00



P. 106 P. 324 P. 423 P. 473



Equinox new

Montatura in metallo placcato. Diffusori in vetro borosilicato trasparente. Colori: montatura cromo con vetro trasparente o fumè sfumato, montatura ottone antico con vetro trasparente o ambra sfumato.



290959



290966



348292



348285



6,500 Kg / 0,0882 m³
G4 max 4 x 2W

€ 550

290959 **Cromo**
290966 **Ottone**
348292 **Fumè sfum. new**
348285 **Ambra Sf. new**



Lampadine LED G4 2W 3000 K incluse.
Cod. **222257**



Lampada con interruttore integrato.



P. 108



P. 425

3000 K
200 lm

222257

€ 4,00



Angolo

Montatura in metallo verniciato a polveri o placcato. Diffusori in vetro bianco, soffiato e acidato. Cavo in PVC nero con interruttore e spina. Finiture: nero oppure ottone satinato.

LED Lampadine LED G9 3W 3000 K incluse. Cod. **209043**

ON OFF Lampada con interruttore integrato.

 
P. 334 P. 476

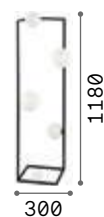

 IP20 

2,700 Kg / 0,1772 m³
G9 max 5 x 28W

€ 280

284309 ■ Nero
284354 ■ Ottone

 3000 K
510 lm
305486 € 6,00



Frame

Base e montatura in metallo verniciato bianco opaco o nero opaco. Diffusori in materiale plastico colore opale. Emissione luce diretta.

LED Sorgente luminosa LED 3000 K, 30.000 h di durata.

ON OFF Lampada con interruttore integrato.



P. 076



P. 247

299624



299617

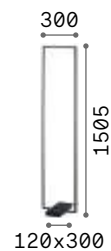

IP20

10,300 Kg / 0,0525 m³
LED 30W / 3100 lm

€ 450

299624 ■ Bianco
299617 ■ Nero



Filo new

Rosone, corpo luce e base a terra in metallo verniciato a polveri o placcato. Diffusore in PC opale satinato. Cavo di sostegno in PVC nero. Alimentato dalla base a terra da cavo nero in PVC con spina. Finiture: bianco, nero oppure ottone.



1,200 Kg / 0,0124 m³
LED 14W / 1500 lm / 1550 lm

€ 250

341118	Bianco	2700K	new
301051	Bianco	3000K	
341125	Nero	2700K	new
301068	Nero	3000K	
341132	Ottone	2700K	new
301075	Ottone	3000K	



Sorgente luminosa LED 2700/3000 K, 20.000 h di durata.



Lampada con interruttore integrato.



P. 084



P. 392



P. 456



Yoko

Base e montatura in metallo verniciato opaco. Diffusore in policarbonato opale. Cavo in pvc con presa-alimentatore. Colori: bianco o nero.

LED Sorgente luminosa LED 3000 K, 30.000 h di durata.

ON OFF Lampada con interruttore integrato.



P. 089



P. 457

258874



258904



IP20

1,650 Kg / 0,0534 m³
LED 16W / 1700 lm

€ 150

258874 ■ Bianco
258904 ■ Nero



Eva

Base in marmo. Montatura in metallo verniciato a polveri. Cavo in PVC con interruttore e spina. Finiture: nero.



Lampada con interruttore integrato.

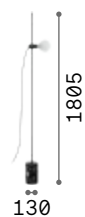

8,500 Kg / 0,0680 m³
E27 max 1x60W

€ 275

295213 ■ Nero

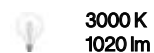

101347 € 6,00



Ping Pong

Montatura in metallo rifinito con vernice a polveri. Diffusori con sfere in acrilico trasparente satinato. Driver integrato. Cavo in pvc con interruttore. Finiture: bianco, nero, ottone spazzolato.

LED Sorgente luminosa LED 3000 K, 50.000 h di durata.

ON/OFF Lampada con interruttore integrato.



328317



313313



328324



IP20

2,500 Kg / 0,0916 m³
LED 12W / 1000 lm

€ 250

328317 **Bianco**
313313 **Nero**
328324 **Ottone**



P. 336



P. 428



P. 472



Look

Base in metallo e corpo luce in alluminio verniciati a polveri.
Diffusore in vetro trasparente. Cavo in pvc. Driver con dimmer da terra.
Finiture: bianco, nero.

LED Sorgente luminosa LED 3000 K,
30.000 h di durata.

 Lampada con dimmer.

 Lampada con interruttore integrato.

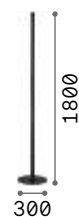

5,080 Kg / 0,0809 m³
LED 24W / 2750 lm

€ 250

304922 ■ Bianco
304915 ■ Nero





Mix Up

Montatura e paralumi intercambiabili in metallo verniciato a polveri. Finiture: bianco oppure nero.



Lampada con interruttore integrato.



288451



307428



IP20

8,500 Kg / 0,0326 m³
E27 max 1x42W

€ 200

328164 ■ Bianco
328171 ■ Nero

3000 K
900 lm

123899 € 6,00

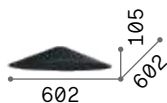

2,000 Kg / 0,0676 m³

€ 85

288437 ■ Bianco
288420 ■ Nero



1,100 Kg / 0,0446 m³

€ 55

307404 ■ Bianco
288475 ■ Nero



0,800 Kg / 0,0147 m³

€ 40

307411 ■ Bianco
288444 ■ Nero

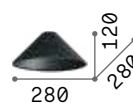

0,500 Kg / 0,0174 m³

€ 35

307428 ■ Bianco
288451 ■ Nero





Craft

Base in metallo verniciato nero opaco. Corpo luce in legno naturale. Diffusore in policarbonato opale satinato. Cavo in PVC nero con dimmer e spina.



LED Sorgente luminosa LED 3000 K, 20.000 h di durata.

 Lampada con dimmer.

 Lampada con interruttore integrato.



P. 091



P. 374

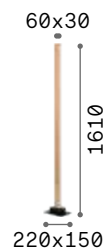

3,500 Kg / 0,0586 m³
LED 26W / 2150 lm

€ 395

284484 ■ Legno



Easy

Montatura in metallo verniciato opaco o placcato. Diffusore orientabile con ottica in acrilico satinato. Cavo in pvc con interruttore e driver integrato sulla spina. Finiture: bianco, nero, ottone spazzolato.

LED Sorgente luminosa LED 3000 K, 50.000 h di durata.



IP20

3,000 Kg / 0,0175 m³
LED 3,5W / 420 lm

€ 130

295473 **Bianco**
295497 **Nero**
295503 **Ottone**



P. 458

Diesis

Montatura in metallo verniciato a polveri o placcato. Diffusore orientabile in rotazione e inclinazione. Cavo in pvc con interruttore. Colori: nero, nickel satinato oppure ottone satinato.

LED Sorgente luminosa LED 3000 K, 20.000 h di durata.



IP20

3,500 Kg / 0,0222 m³
LED 4,5W / 280 lm

€ 180

285337 **Nickel**
279800 **Nero**
285344 **Ottone**



P. 126



P. 459



296685



336220



336220

Comfort new

Montatura in alluminio verniciato a polveri. Doppia sorgente: sopra a emissione diffusa e sotto disponibile con emissione diffusa o concentrata. Sensore di luminosità. Cavo in pvc, con spina. Colori: bianco o nero.

LED Sorgente luminosa LED 3000/4000 K, 50.000 h di durata.

+ Lampada con dimmer.

USB Lampada con presa USB integrata.
Cod. **296685, 306452, 296678, 306469**

UGR Articolo con UGR <16

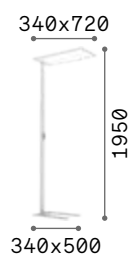
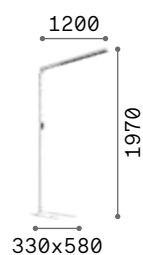

IP20 **+**
19,500 Kg / 0,0638 m³
LED 76W / 9800 lm
€ 1060

IP20 **+**
12,700 Kg / 0,0326 m³
LED 76W / 9700/10800 lm
€ 680

345307 **Bianco** new
336220 **■ Nero** new

296685 **Bianco** 3000K
306452 **Bianco** 4000K
296678 **■ Nero** 3000K
306469 **■ Nero** 4000K



Lift

Montatura in metallo verniciato opaco. Diffusore regolabile in altezza e orientabile con policarbonato opale. Cavo in pvc con driver e interruttore da terra. Finiture: bianco, nero.



LED Sorgente luminosa LED 3000 K, 50.000 h di durata.

ON OFF Lampada con interruttore integrato.



IP20

5,150 Kg / 0,0195 m³
LED 17W / 1950 lm

€ 196

321585 Bianco
305592 Nero

Futura

Braccio in alluminio e plastica, snodato con cavo a vista in pvc. Diffusore orientabile a led e interruttore incorporato. Spina con alimentatore.



LED Sorgente luminosa LED 4000 K, 25.000 h di durata.

Hand icon Lampada con dimmer tattile.



IP20

4,440 Kg / 0,0095 m³
LED 12,5W / 1050 lm

€ 215

272085 Bianco
204956 Alluminio
204949 Nero



P. 460



Ginger new

Base e corpo luce in metallo verniciato a polveri. Diffusore orientabile. Cavo in pvc con interruttore e spina. Versione a due luci con interruttore doppio per accensioni indipendenti. Colori: bianco, nero.

LED Lampadine LED GU10 7W 3000 K incluse. Cod. **123943**

ON OFF Lampada con interruttore integrato.

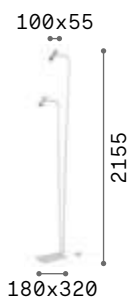

IP20 INCLUSA

5,600 Kg / 0,0260 m³
GU19 max 2x 28W

€ 200

345314 ■ Bianco new
326672 ■ Nero new

3000 K
540 lm

123943 € 3,50

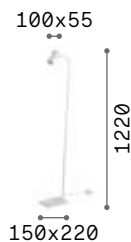

IP20 INCLUSA

2,650 Kg / 0,0246 m³
GU19 max 1x 28W

€ 100

326665 ■ Bianco new
326658 ■ Nero new

3000 K
540 lm

123943 € 3,50



015286

003528



Newton

Montatura e diffusore in metallo.
Disponibile con finitura in nickel satinato o con vernice nera opaca.
Braccio regolabile. Diffusore orientabile smaltato bianco all'interno.



Lampada con interruttore integrato.



P. 426

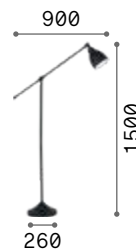

IP20

5,270 Kg / 0,0323 m³
E27 max 1 x 42W

€ 120

015286 ■ Nickel
003528 ■ Nero

3000 K
900 lm

123899 € 3,50



Wally

Montatura in metallo verniciato a polveri con finitura nera, dettagli in metallo nickelato. Struttura a braccio articolato regolabile. Interruttore incorporato sulla testa del paralume. Cavo in pvc.



Lampada con interruttore integrato.

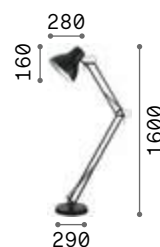

IP20

8,500 Kg / 0,0771 m³
E27 max 1x 42W

€ 250

265292 ■ Nero

3000 K
950 lm

101330 € 4,50



P. 463



Polly

Diffusori e base in metallo cromato, argento o smaltato nero. Dettagli e raccordi in metallo cromato. Diffusori orientabili.



Lampada con interruttore integrato.



IP20

3,500 Kg / 0,0207 m³
E27 max 2 x 60W

€ 125

061122 Cromo
061115 Argento
061139 Nero

3000 K
910 lm
119571 € 3,50



Carta

Montatura in metallo verniciato bianco opaco. Diffusore in policarbonato con rivestimento ad effetto carta.



Lampada con interruttore integrato.



3,150 Kg / 0,0813 m³
E27 max 1x25W

€ 225

317144 Bianco

3000 K
910 lm

119571 € 3,50



1,900 Kg / 0,0370 m³
E27 max 1x25W

€ 110

317137 Bianco

3000 K
910 lm

119571 € 3,50



P. 170



P. 282



P. 385



P. 468





Comet

Base e corpo luce in metallo verniciato a polveri. Diffusore in silicone opale. Interruttore touch integrato su corpo luce. Cavo in pvc con driver e spina. Finiture: bianco, nero.

LED Sorgente luminosa LED 3000 K, 20.000 h di durata.

 Lampada con dimmer.

 Lampada con dimmer tattile.

 Lampada con interruttore integrato.

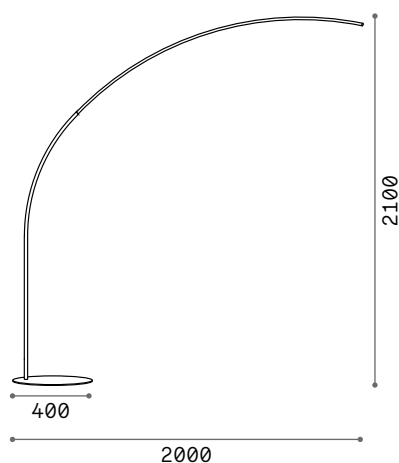
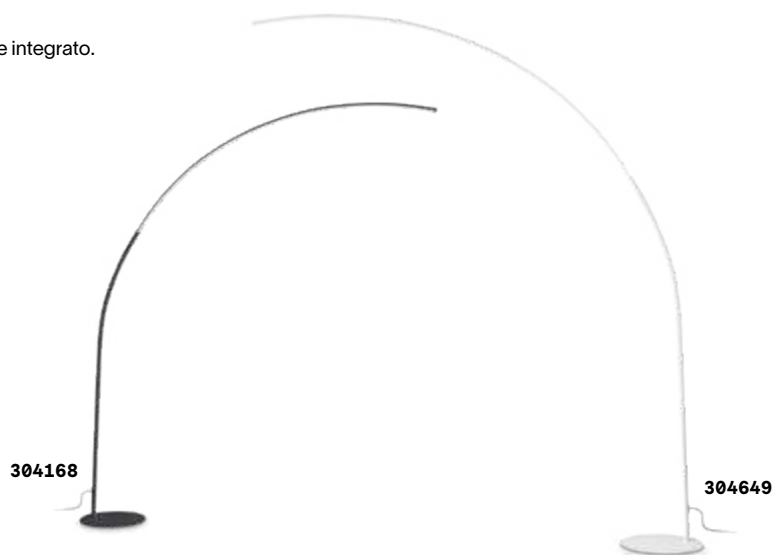

3,800 Kg / 0,0574 m³
LED 30W / 2850 lm

€ 295

304649 ■ Bianco
304168 ■ Nero



Dorsale

Montatura in metallo rifinito in cromo o con vernice opaca bianca o nera. Braccio a sezione quadrata composto da tre elementi. Paralume in lamina di PVC, disponibile in colore cromo o rivestita in tessuto bianco o nero.



Lampada con interruttore integrato.

046471



041742

046723

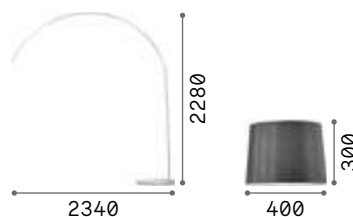
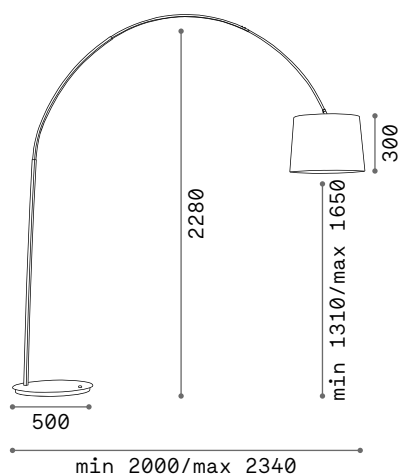

IP20

12,000 Kg / 0,0856 m³
E27 max 1x60W

€ 600

286686 Bianco
286662 Cromo
286679 Nero

0,430 Kg / 0,0709 m³

€ 75

046723 Bianco
041742 Cromo
046471 Nero

3000 K
1050 lm

101347 € 6,00



Daddy

Montatura in metallo. Disponibile in nero e bianco opaco con paralume rivestito in tessuto.

ON
OFF Lampada con interruttore integrato.





Pagoda

Montatura e base in metallo rifinito con smalto satinato. Paralume a inclinazione regolabile rivestito di tessuto.



Lampada con interruttore integrato.



051741

051765



IP20

10,870 Kg / 0,1732 m³
E27 max 1x60W

€ 390

051741 ■ Bianco
051765 ■ Nero

3000 K
1050 lm

101347 € 6,00



Axel

Base e raccordi in metallo verniciato a polveri. Stelo in legno naturale. Paralume regolabile in altezza, in pvc rivestito di tessuto. Cavo in pvc con interruttore. Colori: bianco o nero.

ON
OFF Lampada con interruttore integrato.

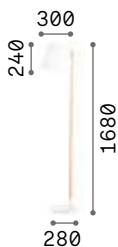

IP20

5,200 Kg / 0,0818 m³
E27 max 1x60W

€ 230

272245 ■ Bianco
282084 ■ Nero

3000 K
1050 lm

101347 € 6,00



P. 478

272245



282084



Driftwood

Montatura in metallo. Elementi decorativi con rami di legno naturale. Diffusore in lamina di pvc rivestito con tessuto canvas.

ON
OFF Lampada con interruttore integrato.



IP20

5,830 Kg / 0,3487 m³
E27 max 1x60W

€ 645

148939 ■ Legno

2200 K
370 lm

151687 € 2,50



IP20

24,000 Kg / 0,1753 m³
E27 max 2x60W

€ 720

180946 ■ Legno

2200 K
370 lm

151687 € 2,50



P. 235



P. 484



York

Base in legno naturale con dettagli in metallo. Paralume in lamina di pvc rivestito in tessuto. Cavo esterno in tessuto. Disponibile anche con montatura e paralume bianchi o neri.



Lampada con interruttore integrato.

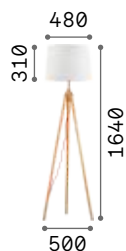

2,810 Kg / 0,0247 m³
E27 max 1x 42W

€ 230

121406 ■ Bianco
121437 ■ Nero
089805 ■ Legno

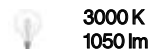

3000 K
1050 lm

101347 € 6,00

Klimt

Treppiede in legno naturale. Paralume in lamina di pvc rivestita in tessuto e con supporto in metallo cromato.



Lampada con interruttore integrato.

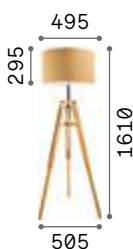

3,870 Kg / 0,1284 m³
E27 max 1x 60W

€ 400

137827 ■ Legno



3000 K
1050 lm

101347 € 6,00



Regol

Montatura snodata in metallo.
 Diffusore regolabile ad altezze diverse. Disponibile con finitura nickel satinato e paralume rivestito in tessuto bianco.



Lampada con interruttore integrato.

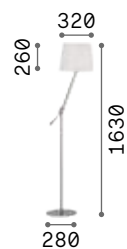

IP20

5,420 Kg / 0,0702 m³
 E27 max 1x60W

€ 280

014609 Bianco

3000 K
 1050 lm

101347 € 6,00



London

Montatura in metallo rifinito in cromo o con vernice opaca bianca o nera. Paralume in lamina di PVC rivestito di tessuto, per la versione cromo in lamina di PVC cromata e semi trasparente.



Lampada con interruttore integrato.



110233

032382

110240

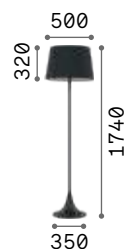

IP20

7,120 Kg / 0,1879 m³
E27 max 1x60W

€ 300

110233 ■ Bianco
032382 ■ Cromo
110240 ■ Nero



3000 K
1050 lm

101347

€ 6,00



P. 479



Set up new

Montatura in metallo verniciato a polveri o placcato. Paralumi in pvc ignifugo rivestito di tessuto. Cavo in pvc. Colori montature: bianco, nero, nichel satinato o ottone spazzolato. Colori paralumi: beige, bianco, nero, tortora, legno.



Lampada con interruttore integrato.



259963

259994

259970

260006

260136

304120

260235

260242

345956

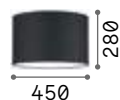

2,640 Kg / 0,0251 m³
E27 max 1x42W

€ 166

259963 Bianco
259994 Nickel
259970 Nero
260006 Ottone

0,470 Kg / 0,0221 m³

€ 92

260457 Bianco
304625 Tortora
270012 Nero
260464 Beige
345895 Legno

0,460 Kg / 0,0709 m³

€ 75

260136 Bianco
304120 Tortora
260235 Nero
260242 Beige
345963 Legno new



3000 K
900 lm

123899

€ 3,50



P. 192



P. 292



P. 434



P. 482



Cylinder

Base in metallo verniciato bianco opaco. Diffusore in vetro soffiato bianco incamiciato e acidato.



Lampada con interruttore integrato.

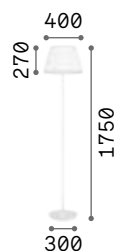

10,010 Kg / 0,1145 m³
E27 max 2x 60W

€ 260

111452 ■ Bianco

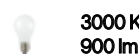

123899 € 3,50



P. 190

Nordik

Montatura in metallo verniciato nero opaco. Paralume in lamina di PVC dorato rivestito in tessuto nero.



Lampada con interruttore integrato.

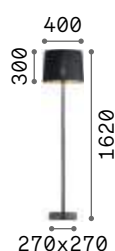

3,620 Kg / 0,0897 m³
E27 max 1x 60W

€ 240

161716 ■ Nero

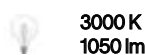

101347 € 6,00



P. 189



P. 436



P. 480



Colonna

Montatura in metallo verniciato bianco o nero opaco. Diffusore in vetro. Cavo in tessuto. Lampadine a LED sostituibili.

LED Lampadine LED GX53 9W 3000 K incluse. Cod. **123936**

ON
OFF Lampada con interruttore integrato.



177199



177205



IP20 

7,740 Kg / 0,0710 m³
GX53 max 4 x 15W

€ 350

177199  Bianco
177205  Nero

 3000 K
910 lm
123936 € 5,00



Opera

Montatura in cromo. Paralume in lamina di PVC con riflessi metallizzati e rivestita da fili. Pendagli in cristallo molato.



Lampada con interruttore integrato.

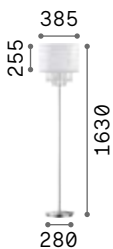

5,720 Kg / 0,0770 m³
E27 max 1x60W

€ 315

068275 Bianco



3000 K
950 lm

101354

€ 6,00



P. 198



P. 440



P. 486



Queen

Montatura in metallo dorato con elementi decorativi e base in cristallo molato. Paralume in lamina di PVC, rivestita in tessuto con decorazione trapuntata e brillantini dorati.



Lampada con interruttore integrato.

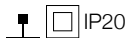

4,900 Kg / 0,0979 m³
E27 max 1x60W

€ 370

077765 Oro



3000 K
1050 lm

101347

€ 6,00



P. 488



Firenze

Corpo luce in resina. Bracci e foglie in metallo modellato artigianalmente. Decorato a mano con foglia d'oro e antichizzato.



Lampada con interruttore integrato.



002880



020877

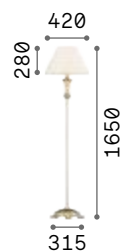

IP20

5,600 Kg / 0,1089 m³
E27 max 1x60W

€ 350

002880 ■ Bianco
020877 ■ Oro

3000 K
1050 lm

101347 € 6,00



P. 230



P. 444



P. 485































Sistemi

Interni

Indice alfabetico

Arca	612
Deva	538
Ego	558
Fluo	626
Linus	624
Office	640
Steel	634
Stick	598

Indice icone

<small>new</small> 	<small>new</small> 	<small>new</small> 	<small>new</small> 	<small>new</small> 
Deva Track 540	Deva Disc 542	Deva Accent 544	Deva Wide Inner 546	Deva Wide Outer 548
<small>new</small> 	<small>new</small> 	<small>new</small> 	<small>new</small> 	
Deva Pendant 550	Ego Single 560	Ego Double 566	Ego Zoom 570	Ego Big 572
	<small>new</small> 	<small>new</small> 		<small>new</small> 
Ego Flat 574	Ego Accent 576	Ego Wide 578	Ego Flexible 580	Ego Pendant 582
<small>new</small> 	<small>new</small> 	<small>new</small> 	<small>new</small> 	
Stick Single 600	Stick Double 602	Stick Accent 604	Stick Wide 606	
				
Arca Track 614	Arca Accent 616	Arca Wide 618	Linus 624	
			<small>new</small> 	
Fluo Wide 628	Fluo Biemission 630	Steel 636	Steel Slim 638	Office 640

Deva ^{new}

Sistema lineare composto da un profilo in alluminio estruso ed elementi di illuminazione a fissaggio magnetico. Il sistema è disponibile in colore nero opaco verniciato o anodizzato, nella modalità d'installazione a plafone o sospensione (SURFACE), incasso rapido a scomparsa nel cartongesso (RECESSED EASY) o incasso senza bordo fra due pannelli di cartongesso (RECESSED). Sezione ridotta del profilo elettrificato larga 10 mm e alta 15 mm, disponibile in due lunghezze 1000 mm e 2000 mm o con raccordo curvo orizzontale a 90°. Possibilità di composizione con diversi moduli luminosi in finitura bianca o nera a seconda della disposizione desiderata, modificabile all'occorrenza: moduli TRACK fissi od orientabili per un'illuminazione spot; moduli ACCENT per un'illuminazione focalizzata; modulo PENDANT TUBE per un'illuminazione localizzata; moduli lineari WIDE INNER completamente interni al profilo, moduli lineari WIDE OUTER esterni al profilo o moduli circolari DISC, per un'illuminazione diffusa e uniforme. Tecnologia a LED integrati con temperatura di colore di 3000 K con elevata resa cromatica CRI ≥ 90 , protezione IP20, classe isolamento III, alimentazione in 24 Vdc, non dimmerabile, durata utile LED 30.000 h L70B50. Ideale per l'illuminazione di piccoli ambienti dove vengono richiesti un ingombro minimo del sistema, un'ampia flessibilità di applicazione e un'elevata qualità di illuminazione, ad esempio spazi RESIDENZIALI, MUSEALI e RETAIL.

Sorgente	LED COB / SMD
Driver incluso	No
Driver disponibili	On/Off
MacAdam	SDCM 3
CCT	3000k
CRI	≥ 90
Durata LED	30.000h
Classe isolamento	III
IP	20
Materiale	Alluminio
Garanzia	5 anni





Deva Track

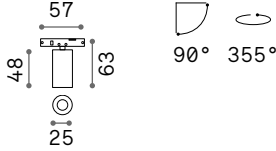

0,030 Kg/0,0002 m³

LED COB OSRAM

Potenza	Angolo	Controllo	Lumen	CCT	Finitura	Codice	€
2,5W	37°	On-Off	150 lm	3000 K	Bianco	332772	35 <small>new</small>
					Nero	332765	35 <small>new</small>

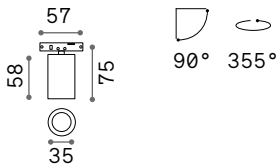

0,050 Kg/0,0003 m³

LED COB BRIDGELUX

Potenza	Angolo	Controllo	Lumen	CCT	Finitura	Codice	€
4,5W	34°	On-Off	450 lm	3000 K	Bianco	332796	40 <small>new</small>
					Nero	332789	40 <small>new</small>

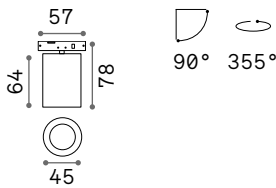

0,090 Kg/0,0004 m³

LED COB BRIDGELUX

Potenza	Angolo	Controllo	Lumen	CCT	Finitura	Codice	€
8 W	30°	On-Off	750 lm	3000 K	Bianco	332826	45 <small>new</small>
					Nero	332819	45 <small>new</small>

Necessario	Angolo	Modello	Codice	€
No	15°	TRACK 2,5W	332543	5 <small>new</small>
		TRACK 4,5W	332505	5 <small>new</small>
		TRACK 8W	332468	5 <small>new</small>



LENS



Light beam: ACCENT

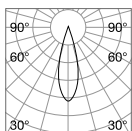

m	lx	Øm
1	913	0,51
2	228	1,00
3	101	1,50
4	57	2,10
5	37	2,60



CRI≥90 4,5W 38° 450lm 3000K

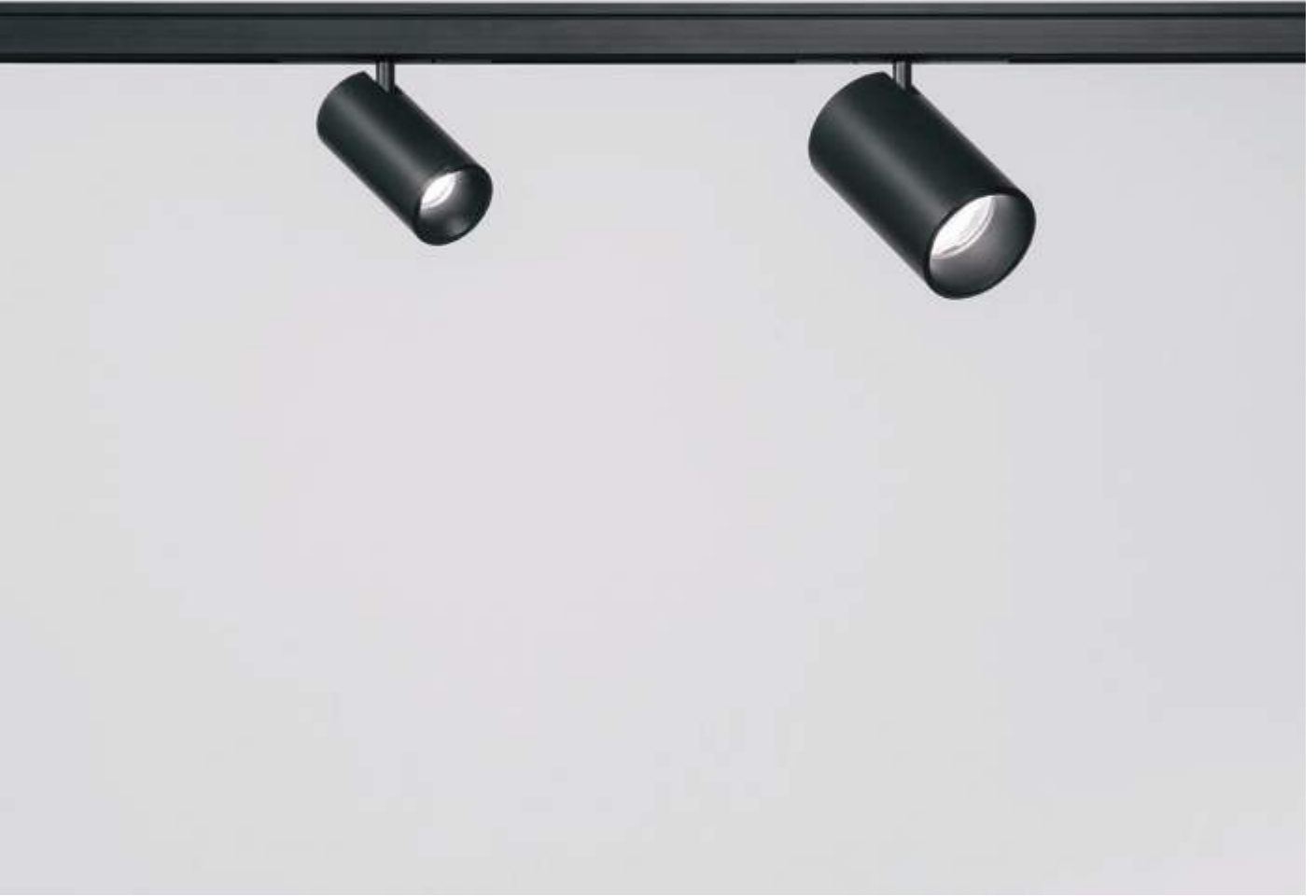

Deva Disc



0,110 Kg/0,0004 m³

LED COB BRIDGELUX

Potenza	Angolo	Controllo	Lumen	CCT	Finitura	Codice	€
5 W	38°	On-Off	500 lm	3000 K	Bianco	332857	40 <small>new</small>
					Nero	332840	40 <small>new</small>

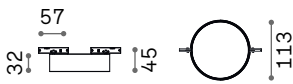

0,330 Kg/0,0020 m³

LED SMD

Potenza	Angolo	Controllo	Lumen	CCT	Finitura	Codice	€
10 W	98°	On-Off	1100 lm	3000 K	Bianco	332888	45 <small>new</small>
					Nero	332864	45 <small>new</small>

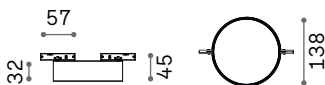

0,430 Kg/0,0020 m³

LED SMD

Potenza	Angolo	Controllo	Lumen	CCT	Finitura	Codice	€
15 W	98°	On-Off	1750 lm	3000 K	Bianco	332918	55 <small>new</small>
					Nero	332901	55 <small>new</small>



Light beam: ACCENT



Light beam: WIDE

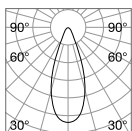

m	lx	cm
1	764	0,68
2	191	1,40
3	85	2,00
4	48	2,70
5	31	3,40

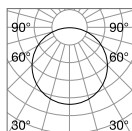

m	lx	cm
1	309	3,30
2	77	6,60
3	34	9,80
4	19	13,00
5	12	16,00



CRI≥90 5W 38° 500lm 3000K

CRI≥90 15W 98° 1750lm 3000K



332840



332901



Deva Accent



LED SMD

Potenza	Angolo	Controllo	Lumen	CCT	Finitura	Codice	€
5 W	34°	On-Off	350 lm	3000 K	Nero	332758	30 <small>new</small>

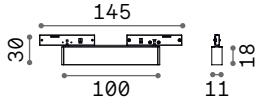

0,070 Kg/0,0002 m³



LED SMD OSRAM

Potenza	Angolo	Controllo	Lumen	CCT	Finitura	Codice	€
10 W	34°	On-Off	900 lm	3000 K	Nero	332734	40 <small>new</small>

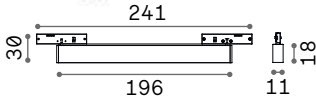

0,140 Kg/0,0003 m³



LED SMD OSRAM

Potenza	Angolo	Controllo	Lumen	CCT	Finitura	Codice	€
14 W	34°	On-Off	1400 lm	3000 K	Nero	332710	50 <small>new</small>

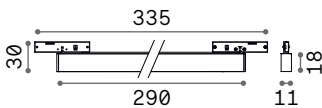

0,230 Kg/0,0005 m³



Light beam: ACCENT

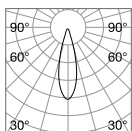

m	lx	Øm
1	913	0,51
2	228	1,00
3	101	1,50
4	57	2,10
5	37	2,60



CRI≥90 5W 34° 350lm 3000K

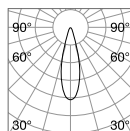

m	lx	Øm
1	2698	0,51
2	675	1,00
3	300	1,50
4	169	2,10
5	108	2,60



CRI≥90 14W 34° 1400lm 3000K



Deva Accent 145 mm



Deva Accent 241 mm



Deva Accent 335 mm



Deva Wide Inner



LED SMD

Potenza	Angolo	Controllo	Lumen	CCT	Finitura	Codice	€
6 W	100°	On-Off	700 lm	3000 K	Nero	332949	25 <small>new</small>

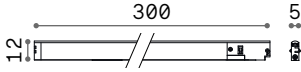

0,020 Kg/0,0001 m³



LED SMD

Potenza	Angolo	Controllo	Lumen	CCT	Finitura	Codice	€
11 W	100°	On-Off	1400 lm	3000 K	Nero	332925	35 <small>new</small>

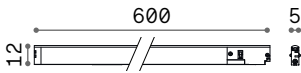

0,080 Kg/0,0003 m³



LED SMD

Potenza	Angolo	Controllo	Lumen	CCT	Finitura	Codice	€
16 W	100°	On-Off	2100 lm	3000 K	Nero	332895	50 <small>new</small>

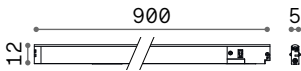

0,130 Kg/0,0004 m³



Light beam: WIDE

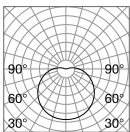

m	lx	Øm
1	161	6,0
2	40	12
3	18	18
4	10	24
5	6,4	30

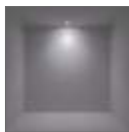

CRI≥90 11W 100° 1400lm 3000K



Deva Wide Inner 300 mm



Deva Wide Inner 600 mm



Deva Wide Inner 900 mm



Deva Wide Outer



LED SMD

Potenza	Angolo	Controllo	Lumen	CCT	Finitura	Codice	€
8 W	100°	On-Off	900 lm	3000 K	Nero	332871	25 <small>new</small>

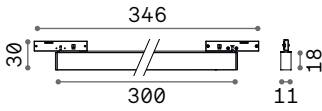

0,130 Kg/0,0005 m³



LED SMD

Potenza	Angolo	Controllo	Lumen	CCT	Finitura	Codice	€
12 W	100°	On-Off	1350 lm	3000 K	Nero	332833	35 <small>new</small>

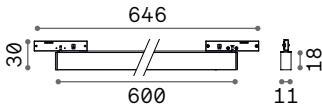

0,330 Kg/0,0008 m³



LED SMD

Potenza	Angolo	Controllo	Lumen	CCT	Finitura	Codice	€
21 W	100°	On-Off	2700 lm	3000 K	Nero	332802	50 <small>new</small>

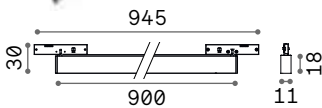

0,310 Kg/0,0012 m³



Light beam: WIDE

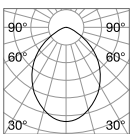

m	lx	Øm
1	257	1,90
2	64	3,70
3	29	5,60
4	16	7,50
5	10	9,40

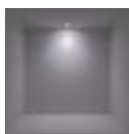

CRI≥90 12W 100° 1350lm 3000K



Deva Wide Outer 346 mm



Deva Wide Outer 646 mm



Deva Wide Outer 945 mm



Deva Pendant

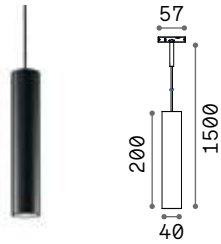

LED COB BRIDGELUX

Potenza	Angolo	Controllo	Lumen	CCT	Finitura	Codice	€
6 W	34°	On-Off	550 lm	3000 K	Nero	332932	45 <small>new</small>

0,280 Kg/0,0009 m³



Light beam: ACCENT

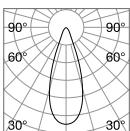

m	lx	øm
1	742	0,68
2	186	1,40
3	82	2,00
4	46	2,70
5	30	3,40



CRI≥90 6W 34° 550lm 3000K



Deva Surface

PROFILE SURFACE Kit di montaggio non necessario, fissaggio diretto a soffitto
Lunghezza massima per punto di alimentazione: 10 metri



Lunghezza	Peso	Volume	Finitura	Codice	€
1000 mm	0,280 Kg	0,0003 m ³	Nero	332475	20 <small>new</small>
2000 mm	0,470 Kg	0,0007 m ³	Nero	332482	40 <small>new</small>

SURFACE CORNER ROUND Optional

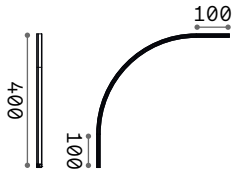

Peso	Volume	Controllo	Finitura	Codice	€
0,056 Kg	0,0014 m ³	On-Off	Nero	339375	91 <small>new</small>

SURFACE CORNER L Optional

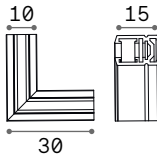

Peso	Volume	Controllo	Finitura	Codice	€
0,020 Kg	0,0002 m ³	On-Off	Nero	339382	41 <small>new</small>

LINEAR CONNECTOR Necessario - 1 Kit x giunzione lineare

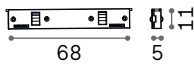

Peso	Volume	Controllo	Finitura	Codice	€
0,009 Kg	0,0001 m ³	On-Off	Nero	339368	18 <small>new</small>

MAIN CONNECTOR Necessario - 1 Kit x punto di alimentaz. max 140W

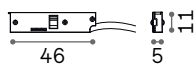

Peso	Volume	Controllo	Finitura	Codice	€
0,001 Kg	0,0002 m ³	On-Off	Nero	332581	15 <small>new</small>

Lunghezza cavo 1500 mm

DRIVER ON/OFF Necessario



Potenza	Output	Classe	Misura (LxHxP)	Codice	€
75 W	24 Vdc	<input type="checkbox"/>	168x30x38 mm	332659	65 <small>new</small>
150 W	24 Vdc	<input type="checkbox"/>	227x30x38 mm	332628	95 <small>new</small>



END CAP (2pcs. incl.)

Necessario	Misura (LxHxP)	Finitura	Codice	€
SI	10x7x15 mm	Nero	332635	3 <small>new</small>



KIT PENDANT

Necessario	Misura (LxHxP)	Finitura	Codice	€
SI	8x7x2050 mm	Nero	332703	15 <small>new</small>

Deva - Assembly plans

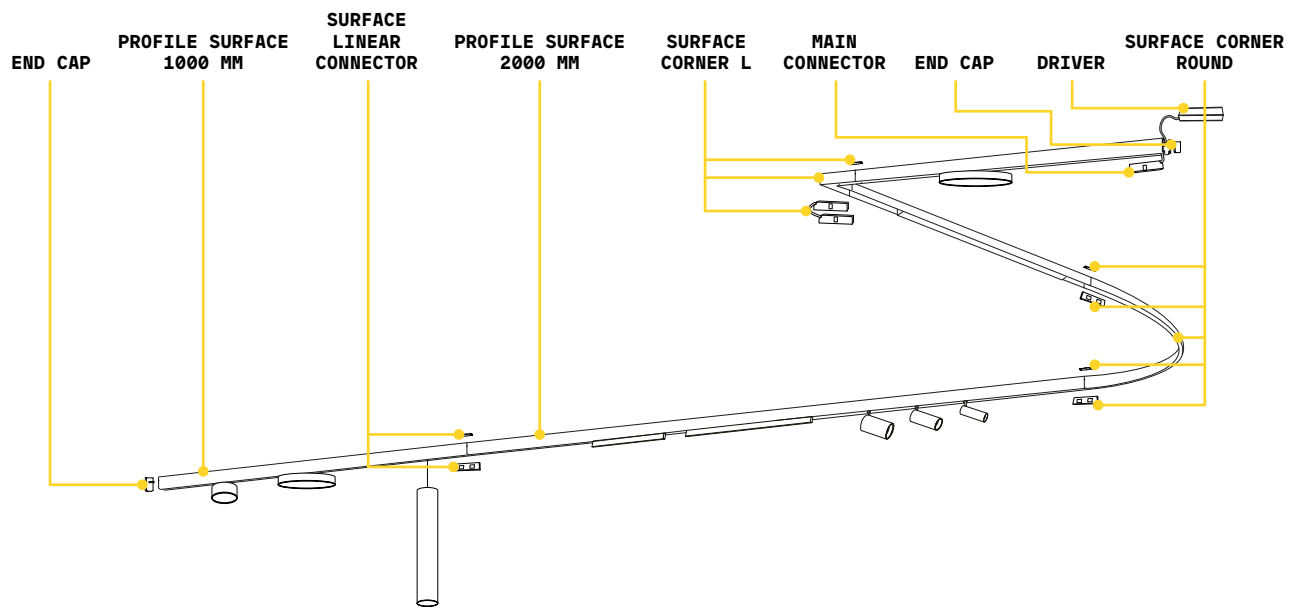
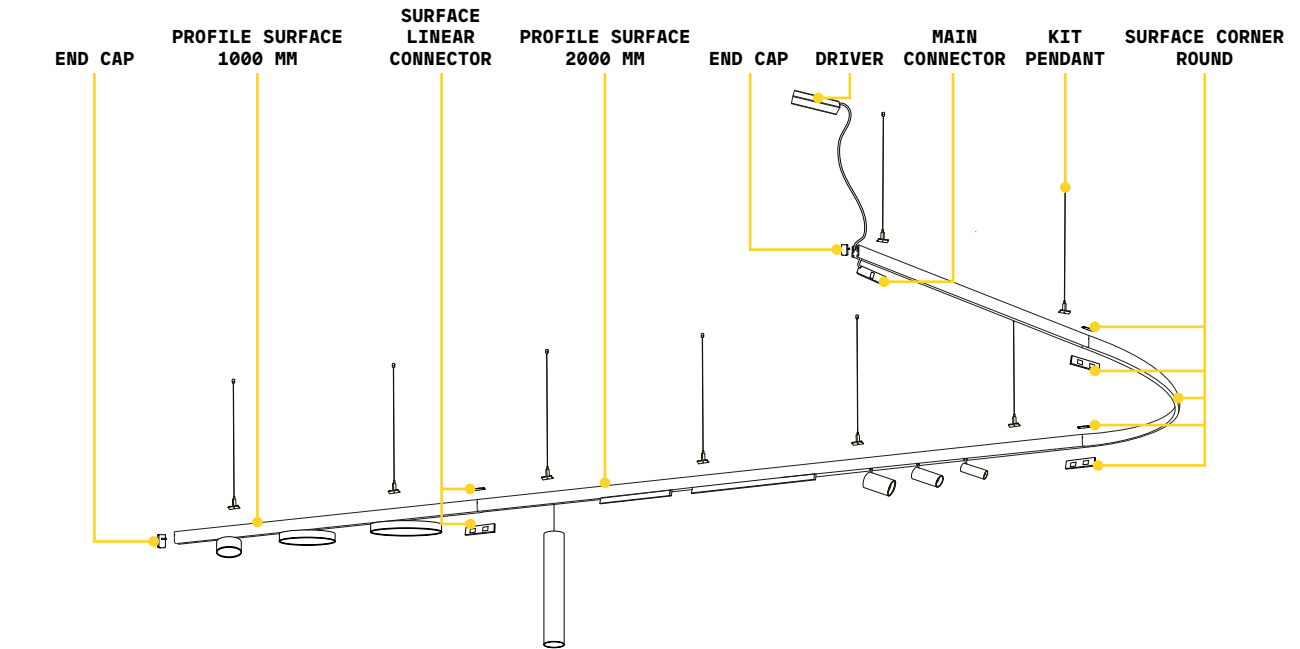

Deva - Recessed

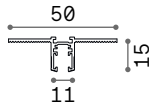

PROFILE RECESSED Kit di montaggio non necessario, fissaggio diretto a soffitto
Lunghezza massima per punto di alimentazione: 10 metri

Lunghezza	Peso	Volume	Finitura	Codice	€
1000 mm	0,370 Kg	0,0017 m ³	Nero	332529	20 <small>new</small>
2000 mm	0,670 Kg	0,0034 m ³	Nero	332536	40 <small>new</small>

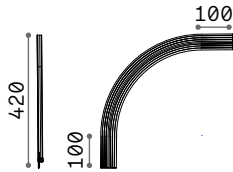

RECESSED CORNER ROUND Optional

Peso	Volume	Controllo	Finitura	Codice	€
0,267 Kg	0,0023 m ³	On-Off	Nero	339405	91 <small>new</small>

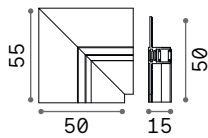

RECESSED CORNER L Optional

Peso	Volume	Controllo	Finitura	Codice	€
0,030 Kg	0,0003 m ³	On-Off	Nero	339412	41 <small>new</small>

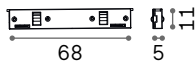

RECESSED LINEAR CONNECTOR Necessario - 1 Kit x giunzione lineare

Peso	Volume	Controllo	Finitura	Codice	€
0,020 Kg	0,0001 m ³	On-Off	Nero	339399	18 <small>new</small>

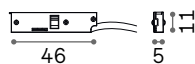

MAIN CONNECTOR Necessario - 1 Kit x punto di alimentaz. max 140W

Peso	Volume	Controllo	Finitura	Codice	€
0,060 Kg	0,0002 m ³	On-Off	Nero	332581	15 <small>new</small>

Lunghezza cavo 1500 mm

DRIVER ON/OFF Necessario



Potenza	Output	Classe	Misura (LxHxP)	Codice	€
75 W	24 Vdc	<input type="checkbox"/>	168x30x38 mm	332659	65 <small>new</small>
150 W	24 Vdc	<input type="checkbox"/>	227x30x38 mm	332628	95 <small>new</small>



END CAP (2pcs. incl.)

Necessario	Misura (LxHxP)	Finitura	Codice	€
SI	10x7x15 mm	Nero	332635	3

Deva - Assembly plans

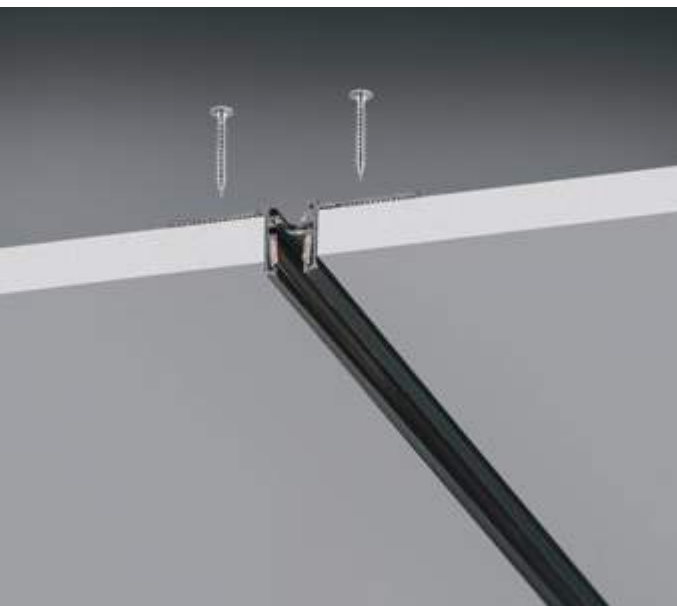
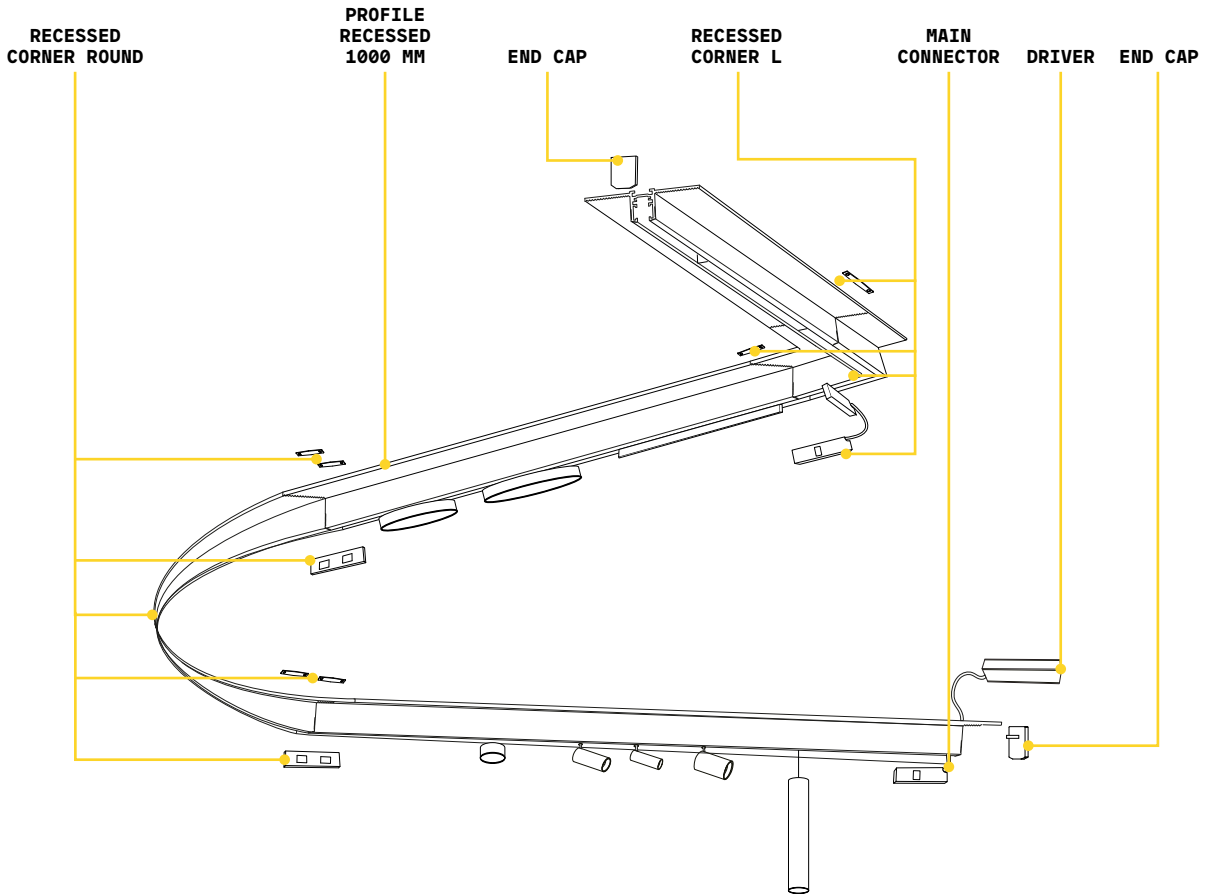

Deva - Recessed Easy

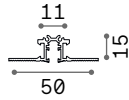

PROFILE Kit di montaggio non necessario, fissaggio diretto a soffitto
RECESSED EASY Lunghezza massima per punto di alimentazione: 10 metri

Lunghezza	Peso	Volume	Finitura	Codice	€
1000 mm	0,370 Kg	0,0017 m ³	Nero	332499	25 <small>new</small>
2000 mm	0,870 Kg	0,0034 m ³	Nero	332512	50 <small>new</small>

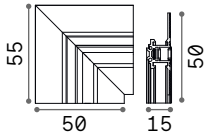

RECESSED EASY CORNER L Optional

Peso	Volume	Controllo	Finitura	Codice	€
0,030 Kg	0,0004 m ³	On-Off	Nero	339429	41 <small>new</small>

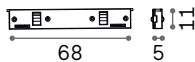

RECESSED LINEAR CONNECTOR Necessario - 1 Kit x giunzione lineare

Peso	Volume	Controllo	Finitura	Codice	€
0,020 Kg	0,0001 m ³	On-Off	Nero	339399	18 <small>new</small>

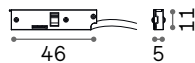

MAIN CONNECTOR Necessario - 1 Kit x punto di alimentaz. max 140W

Peso	Volume	Controllo	Finitura	Codice	€
0,060 Kg	0,0002 m ³	On-Off	Nero	332581	15 <small>new</small>

Lunghezza cavo 1500 mm

DRIVER ON/OFF Necessario



Potenza	Output	Classe	Misura (LxHxP)	Codice	€
75 W	24 Vdc	<input type="checkbox"/>	168x30x38 mm	332659	65 <small>new</small>
150 W	24 Vdc	<input type="checkbox"/>	227x30x38 mm	332628	95 <small>new</small>



END CAP (2pcs. incl.)

Necessario	Misura (LxHxP)	Finitura	Codice	€
SI	10x7x15 mm	Nero	332635	3 <small>new</small>

Deva - Assembly plans

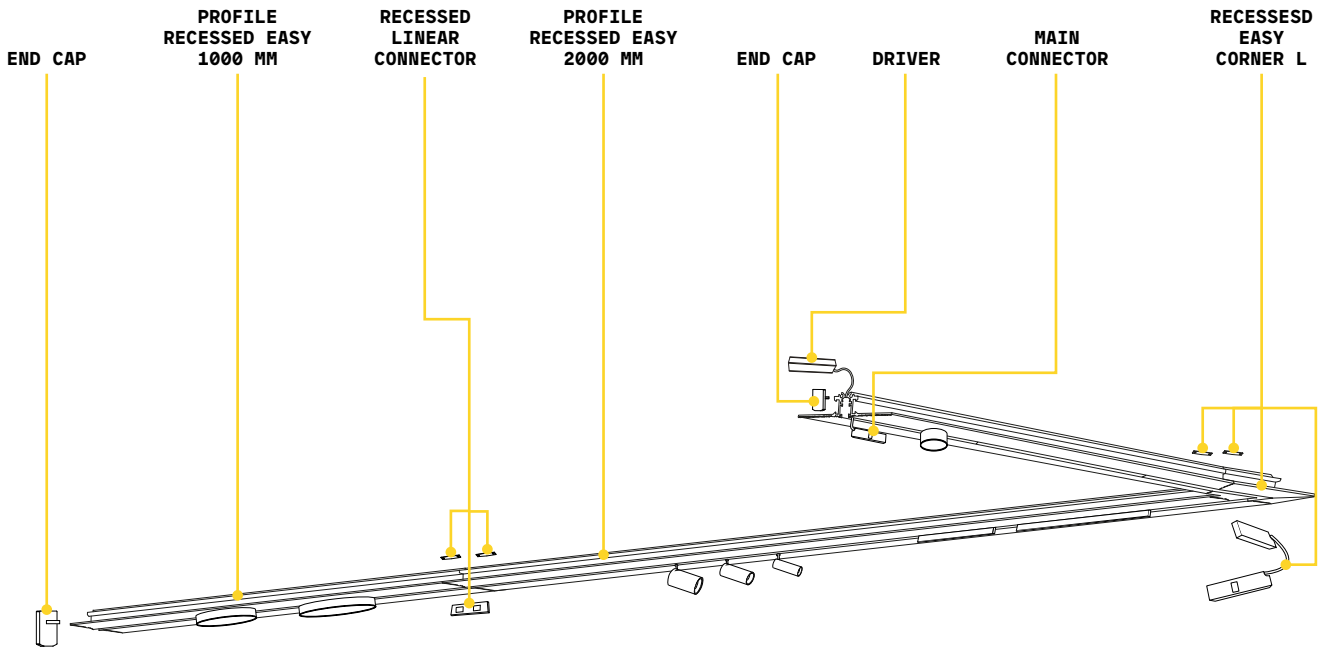

Ego new

Sistema lineare composto da un profilo in alluminio estruso ed elementi di illuminazione con fissaggio meccanico di sicurezza. Il sistema è disponibile in colore nero opaco RAL 9005, bianco opaco RAL 9016 oppure ottone satinato anodizzato, nella modalità d'installazione a plafone o sospensione (LOW e HIGH), incasso senza bordo a scomparsa nel cartongesso (RECESSED), incasso rapido nel cartongesso (RECESSED EASY) o incasso con bordo per controsoffitti in cartongesso o a pannelli (RECESSED TRIM). Sezione ridotta del profilo larga 26 mm e alta 27 mm o 52 mm, disponibile in due lunghezze 1000 mm e 2000 mm. Possibilità di composizione con diversi moduli luminosi a seconda della disposizione desiderata, modificabile all'occorrenza: i moduli TRACK SINGLE, DOUBLE e FLAT SINGLE per un'illuminazione spot, il modulo TRACK ZOOM per un'illuminazione mirata con regolazione dell'apertura del fascio senza utensili, il modulo ACCENT con controllo dell'abbagliamento (UGR < 19), i moduli PENDANT TUBE per un'illuminazione localizzata e i moduli WIDE o PENDANT BALL per un'illuminazione diffusa e uniforme. Tecnologia a LED integrati con temperatura di colore di 2700 K, 3000 K o 4000 K; indice di resa cromatica CRI ≥ 90, binning iniziale ≤ 3Step MacAdam; protezione IP20, classe isolamento III, alimentazione in 48 Vdc, durata utile LED 50.000 h L70B50; sistema disponibile anche in versione dimmerabile 1-10V o DALI-2. Ideale per l'illuminazione di piccoli e grandi ambienti dove viene richiesta ampia flessibilità ed elevata qualità di illuminazione, ad esempio spazi MUSEALI, COMMERCIALI, RESIDENZIALI e RETAIL.

PRO

Prodotto ad alto contenuto tecnologico, elevata qualità dei materiali, destinato ad uso professionale.

UGR

Articolo con UGR < 19 (Accent, Pendant).

Sorgente	LED COB / SMD
Driver incluso	No
Driver disponibili	On/Off
Controllo	1-10V / DALI
MacAdam	SDCM 3
CCT	2700 K / 3000 K / 4000 K
CRI	≥90
UGR	<19 (Accent, Pendant)
Durata LED	50.000h
Classe isolamento	III
IP	20
Materiale	Alluminio
Garanzia	5 anni





Ego Track Single



LED SMD OSRAM

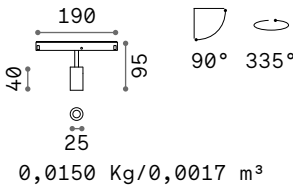

Potenza	Angolo	Controllo	Lumen	CCT	Finitura	Codice	€
3W	30°	On-Off	200 lm	3000 K	Bianco	282978	80
			220 lm	4000 K	Nero	257617	80
1-10V	30°	On-Off	200 lm	3000 K	Bianco	303673	100
			200 lm	3000 K	Nero	303666	100
		DALI	200 lm	3000 K	Bianco	286402	125
			200 lm	3000 K	Nero	286396	125



FILTER HONEYCOMB



LENS

Modello	Necessario	Angolo	Finitura	Codice	€
Ego 3W	No		Nero	260853	5
Ego 3W	No	18°	Trasparen.	332062	5 <small>new</small>
		45°	Trasparen.	332079	5 <small>new</small>



Light beam: ACCENT

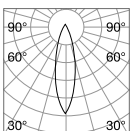

m	lx	Øm
1	537	0,46
2	134	0,92
3	60	1,40
4	34	1,80
5	21	2,30



CRI≥90 3W 30° 200lm 3000K

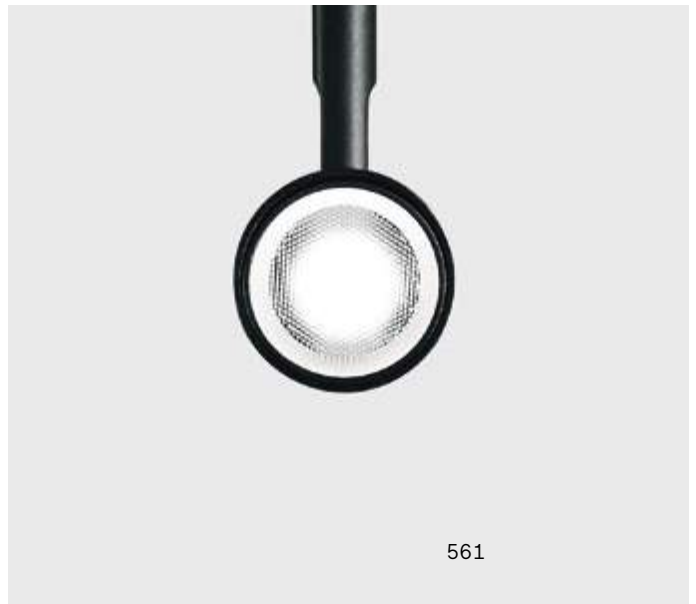

Ego Track Single



LED COB CITIZEN

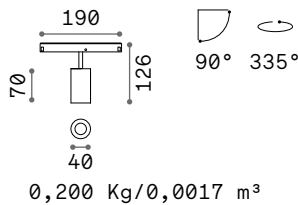

Potenza	Angolo	Controllo	Lumen	CCT	Finitura	Codice	€	
8 W	30°	On-Off	720 lm	2700 K	Nero	340388	95 <i>new</i>	
			850 lm	3000 K	Bianco	282985	95	
					Nero	257631	95	
			900 lm	4000 K	Nero	317984	95	
			850 lm	3000 K	Bianco	303697	110	
					Nero	303680	110	
		1-10V	DALI	720 lm	2700 K	Nero	340364	135 <i>new</i>
				850 lm	3000 K	Bianco	286426	135
						Nero	286419	135



LED COB CITIZEN

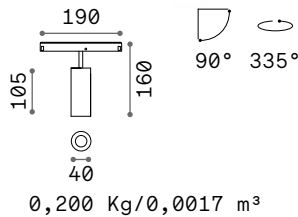

Potenza	Angolo	CCT	Lumen	Controllo	Finitura	Codice	€	
12 W	30°	On-Off	1000 lm	2700 K	Nero	340425	95 <i>new</i>	
			1200 lm	3000 K	Bianco	282992	95	
					Nero	257655	95	
			1250 lm	4000 K	Nero	321967	95	
			1200 lm	3000 K	Bianco	303710	110	
					Nero	303703	110	
		1-10V	DALI	1000 lm	2700 K	Nero	340401	140 <i>new</i>
				1200 lm	3000 K	Bianco	286440	140
						Nero	286433	140



FILTER HONEYCOMB



LENS*

Modello	Necessario	Angolo	Finitura	Codice	€
TRACK8W/12W	No		Nero	260860	5
TRACK8W/12W	No	18°	Trasparen.	332086	5 <i>new</i>
		45°	Trasparen.	332093	5 <i>new</i>



Light beam: ACCENT

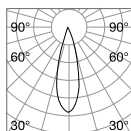

m	lx	Øm
1	2393	0,49
2	598	0,98
3	266	1,50
4	150	2,00
5	96	2,50

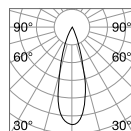

m	lx	Øm
1	2877	0,51
2	719	1,00
3	320	1,50
4	180	2,10
5	115	2,60



CRI≥90 8W 30° 850lm 3000K

CRI≥90 12W 30° 1200lm 3000K



Ego Track Single

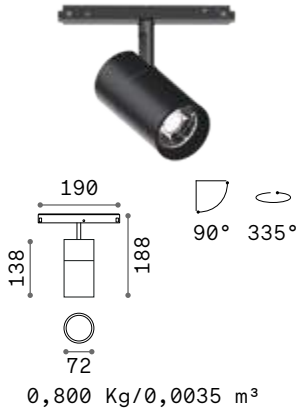

LED COB CITIZEN

Potenza	Angolo	Controllo	Lumen	CCT	Finitura	Codice	€
19W	35°	On-Off	2200 lm	3000 K	Bianco	307558	140
			2350 lm	4000 K	Nero	305608	140
			2200 lm	3000 K	Nero	321998	140
		DALI	2200 lm	3000 K	Bianco	307527	155
			2200 lm	3000 K	Nero	307510	155
			2200 lm	3000 K	Nero	307534	185

LED COB CITIZEN

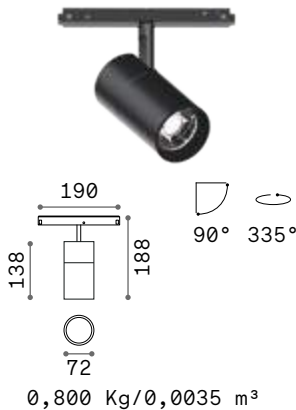

Potenza	Angolo	Controllo	Lumen	CCT	Finitura	Codice	€
26W	35°	On-Off	3050 lm	3000 K	Bianco	307602	140
			3150 lm	4000 K	Nero	305615	140
			3050 lm	3000 K	Nero	317991	140
		DALI	3050 lm	3000 K	Bianco	307572	155
			3050 lm	3000 K	Nero	307565	155
			3050 lm	3000 K	Nero	307589	185



LENS

Modello	Necessario	Angolo	Finitura	Codice	€
TRACK 19W/26W	No	20°	Trasparen.	332109	10 new
		55°	Trasparen.	332116	10 new



Light beam: ACCENT

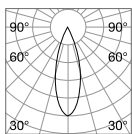

m	lx	cm
1	4476	0,57
2	1119	1,10
3	497	1,70
4	280	2,30
5	179	2,90

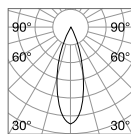

m	lx	cm
1	6816	0,56
2	1704	1,10
3	757	1,70
4	426	2,20
5	273	2,80



CRI≥90 19W 35° 2200lm 3000K

CRI≥90 26W 35° 3050lm 3000K



Ego Track Double



LED SMD OSRAM

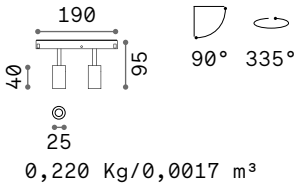

Potenza	Angolo	Controllo	Lumen	CCT	Finitura	Codice	€
5 W	30°	On-Off	400 lm	3000 K	Bianco	282947	100
			430 lm	4000 K	Nero	257624	100
1-10V	30°	On-Off	400 lm	3000 K	Bianco	303611	115
			400 lm	3000 K	Nero	303604	115
			400 lm	3000 K	Bianco	286341	145
			400 lm	3000 K	Nero	286334	145



FILTER HONEYCOMB



LENS*

Modello	Necessario	Angolo	Finitura	Codice	€
TRACK5 W	No		Nero	260853	5
TRACK5 W	No	18°	Trasparen.	332062	5 <small>new</small>
		45°	Trasparen.	332079	5 <small>new</small>



Light beam: ACCENT

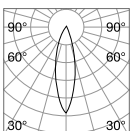

m	lx	Øm
1	508	0,46
2	127	0,92
3	56	1,40
4	32	2,80
5	20	2,30



CRI≥90 5W 30° 400lm 3000K



Ego Track Double

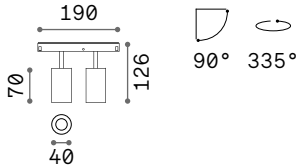

0,450 Kg/0,0017 m³

LED COB CITIZEN

Potenza	Angolo	Controllo	Lumen	CCT	Finitura	Codice	€	
16 W	30°	On-Off	1400 lm	2700 K	Nero	340265	135 <i>new</i>	
					Bianco	282954	135	
			Nero	257648	135			
				1550 lm	4000 K	Nero	321806	135
			1-10V	1500 lm	3000 K	Bianco	303635	150
						Nero	303628	150
		DALI	1400 lm	2700 K	Nero	340241	180 <i>new</i>	
					1500 lm	3000 K	Bianco	286365
						Nero	286358	180

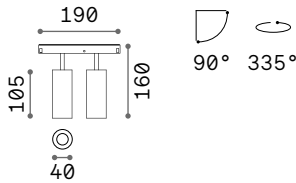

0,330 Kg/0,0027 m³

LED COB CITIZEN

Potenza	Angolo	Controllo	Lumen	CCT	Finitura	Codice	€	
24 W	30°	On-Off	2400 lm	3000 K	Bianco	282961	145	
					Nero	257662	145	
			Nero	2500 lm	4000 K	Nero	321844	145
				1-10V	2400 lm	3000 K	Bianco	303659
			Nero				303642	155
			DALI	2400 lm	3000 K	Bianco	286389	185
		Nero				286372	185	



FILTER HONEYCOMB



LENS*

Modello	Necessario	Angolo	Finitura	Codice	€
TRACK16W/24W	No		Nero	260860	5
TRACK16W/24W	No	18°	Trasparen.	332086	5 <i>new</i>
		45°	Trasparen.	332093	5 <i>new</i>



Light beam: ACCENT

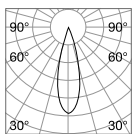

m	lx	Øm
1	2451	0,49
2	613	1,98
3	272	1,50
4	153	2,00
5	98	2,50



CRI≥90 16W 30° 1450lm 3000K

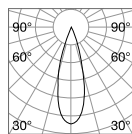

m	lx	Øm
1	3051	0,51
2	763	1,00
3	339	1,50
4	191	2,10
5	122	2,60



CRI≥90 24W 30° 2000lm 3000K



Ego Track Zoom

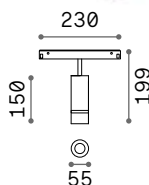
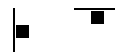

0,500 Kg/0,0035 m³

LED COB CITIZEN

Potenza	Angolo	Controllo	Lumen	CCT	Finitura	Codice	€
10 W	20° - 40°	On-Off	1000 lm	3000 K	Nero	330730	120 <i>new</i>
			1100 lm	4000 K	Nero	340197	120 <i>new</i>
		DALI	1000 lm	3000 K	Nero	330754	175 <i>new</i>
			1100 lm	4000 K	Nero	340180	175 <i>new</i>



Light beam: from SPOT to WIDE

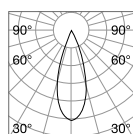

m	lx	Øm
1	2185	0,67
2	546	1,30
3	243	2,00
4	137	2,70
5	87	3,30



CRI≥90 10W 20°-40° 1000lm 3000K



Ego Track Big

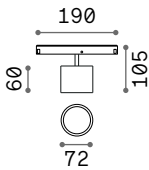

0,470 Kg/0,0026 m³

LED COB CITIZEN UGR <19

Potenza	Angolo	Controllo	Lumen	CCT	Finitura	Codice	€
10 W	38°	On-Off	1000 lm	3000 K	Bianco	327556	110
					Nero	300764	110

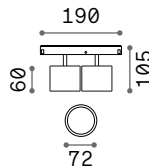

0,750 Kg/0,0026 m³

LED COB CITIZEN UGR <19

Potenza	Angolo	Controllo	Lumen	CCT	Finitura	Codice	€
20 W	38°	On-Off	2000 lm	3000 K	Bianco	327549	190
					Nero	316307	190



Light beam: ACCENT

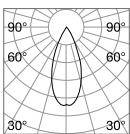

m	lx	Øm
1	1296	0,76
2	324	1,50
3	144	2,30
4	81	3,00
5	52	3,80

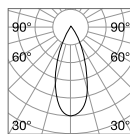

m	lx	Øm
1	2964	0,71
2	741	1,40
3	329	2,10
4	185	2,80
5	119	3,60



CRI≥90 10W 38° 1000lm 3000K

CRI≥90 20W 38° 2000lm 3000K



Ego Track Flat

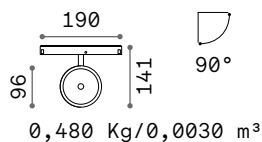
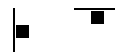

LED COB CITIZEN

Potenza	Angolo	Controllo	Lumen	CCT	Finitura	Codice	€
9W	36°	On-Off	1100 lm	3000 K	Bianco	300504	105
					Nero	290614	105
		1-10V	1100 lm	3000 K	Bianco	303741	120
					Nero	303727	120
		DALI	1100 lm	3000 K	Bianco	300535	150
					Nero	300528	150



Light beam: ACCENT

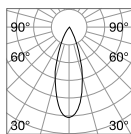

m	lx	Øm
1	2242	0,60
2	560	1,20
3	249	1,80
4	140	2,40
5	90	3,00



CRI≥90 9W 36° 1100lm 3000K



Ego Accent

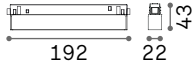

0,140 Kg/0,0013 m³

LED SMD OSRAM UGR <19

Potenza	Angolo	Controllo	Lumen	CCT	Finitura	Codice	€	
7W	35°	On-Off	630 lm	2700 K	Nero	340067	100 <i>new</i>	
			700 lm	3000 K	Bianco	282633	100	
					Nero	257792	100	
			730 lm	4000 K	Nero	323596	100	
			700 lm	3000 K	Bianco	303505	135	
					Nero	303499	135	
		1-10V	DALI	630 lm	2700 K	Nero	340043	145 <i>new</i>
				700 lm	3000 K	Bianco	286068	145
						Nero	286051	145

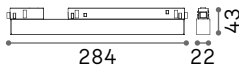

0,330 Kg/0,0010 m³

LED SMD OSRAM UGR <19

Potenza	Angolo	Controllo	Lumen	CCT	Finitura	Codice	€	
13W	35°	On-Off	1250 lm	2700 K	Nero	340104	140 <i>new</i>	
			1400 lm	3000 K	Bianco	282640	140	
					Nero	257686	140	
			1450 lm	4000 K	Nero	317953	140	
			1400 lm	3000 K	Bianco	303529	170	
					Nero	303512	170	
		1-10V	DALI	1250 lm	2700 K	Nero	340081	200 <i>new</i>
				1400 lm	3000 K	Bianco	286082	200
						Nero	286075	200



Light beam: ACCENT

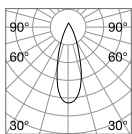

m	lx	Øm
1	3121	0,61
2	780	1,20
3	347	1,80
4	195	2,40
5	125	3,00



CRI≥90 13W 35° 1400lm 3000K



Ego Accent 192 mm



Ego Accent 284 mm



Ego Wide

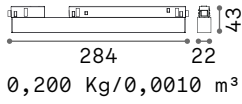

0,200 Kg/0,0010 m³

LED SMD SAMSUNG

Potenza	Angolo	Controllo	Lumen	CCT	Finitura	Codice	€
7W	110°	On-Off	850 lm	3000 K	Bianco	283029	75
					Nero	257709	75
		1-10V	880 lm	4000 K	Nero	317960	75
			850 lm	3000 K	Bianco	303796	120
					Nero	303789	120
			DALI	850 lm	3000 K	Bianco	286501
Nero	286495	120					

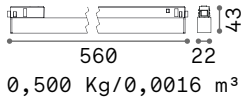

0,500 Kg/0,0016 m³

LED SMD SAMSUNG

Potenza	Angolo	Controllo	Lumen	CCT	Finitura	Codice	€
13W	110°	On-Off	1450 lm	2700 K	Nero	340586	100 <small>new</small>
			1700 lm	3000 K	Bianco	283036	100
		1-10V	1750 lm	4000 K	Nero	257716	100
					Nero	322056	100
			1700 lm	3000 K	Bianco	303819	130
					Nero	303802	130
		DALI	1450 lm	2700 K	Nero	340562	145 <small>new</small>
					1700 lm	3000 K	Bianco
			1700 lm	3000 K	Nero	286518	145

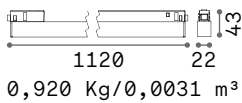

0,920 Kg/0,0031 m³

LED SMD SAMSUNG

Potenza	Angolo	Controllo	Lumen	CCT	Finitura	Codice	€
26W	110°	On-Off	2900 lm	2700 K	Nero	340623	145 <small>new</small>
			3400 lm	3000 K	Bianco	283043	145
		1-10V	3500 lm	4000 K	Nero	257730	145
					Nero	322070	145
			3400 lm	3000 K	Bianco	303833	160
					Nero	303826	160
		DALI	2900 lm	2700 K	Nero	340609	185 <small>new</small>
					3400 lm	3000 K	Bianco
			3400 lm	3000 K	Nero	286532	185



Light beam: WIDE

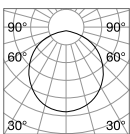

m	lx	Øm
1	619	2,50
2	155	4,90
3	69	7,40
4	39	9,80
5	25	12,00

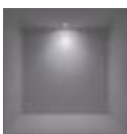

CRI≥90 26W 110° 3400lm 3000K



Ego Wide 284 mm



Ego Wide 560 mm



Ego Wide 1120 mm



Ego Flexible

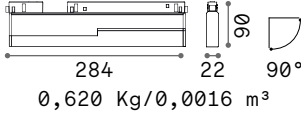

LED SMD OSRAM UGR <19

Potenza	Angolo	Lumen	CCT	Controllo	Finitura	Codice	€
13 W	35°	1400 lm	3000 K	On-Off	Bianco	282718	175
					Nero	257846	175
				DALI	Bianco	286105	215
					Nero	286099	215



LED SMD SAMSUNG

Potenza	Angolo	Lumen	CCT	Controllo	Finitura	Codice	€
7 W	110°	850 lm	3000 K	On-Off	Bianco	282725	120
					Nero	257839	120
				DALI	Bianco	286129	160
					Nero	286112	160



Light beam: ACCENT



Light beam: WIDE

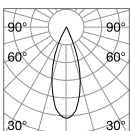

m	lx	cm
1	3112	0,61
2	778	1,20
3	346	1,80
4	194	2,40
5	124	3,00

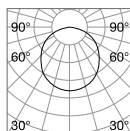

m	lx	cm
1	231	2,90
2	58	5,80
3	26	8,60
4	14	12,00
5	9	14,00



CRI≥90 13W 35° 1400lm 3000K

CRI≥90 7W 110° 850lm 3000K

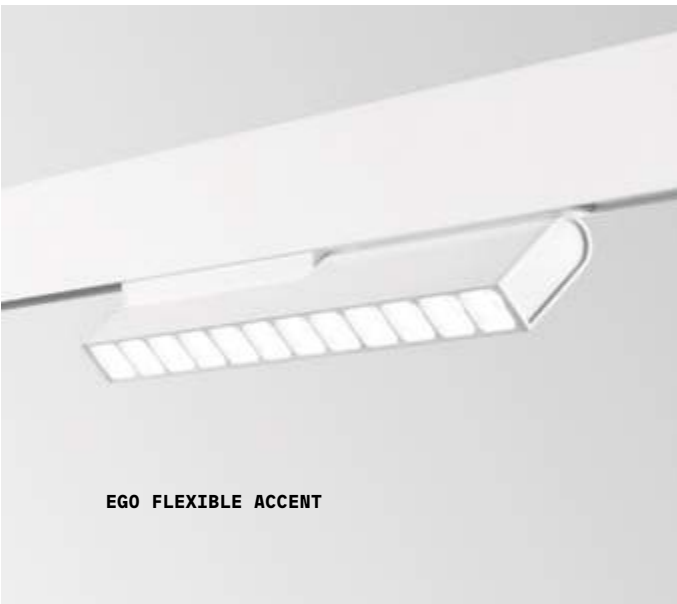

EGO FLEXIBLE ACCENT



EGO FLEXIBLE WIDE

Ego Pendant

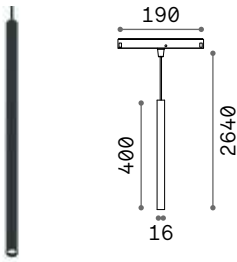

0,150 Kg/0,0020 m³

LED COBCITIZEN UGR <19

Potenza	Angolo	Controllo	Lumen	CCT	Finitura	Codice	€
5,5W	66°	On-Off	530 lm	3000 K	Nero	332451	90 <small>new</small>
		1-10V	530 lm	3000 K	Nero	344782	110 <small>new</small>
		DALI	530 lm	3000 K	Nero	344799	140 <small>new</small>

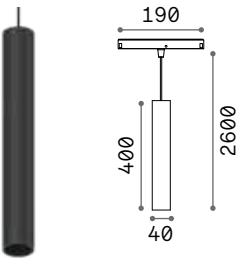

0,550 Kg/0,0023 m³

LED COBCITIZEN UGR <19

Potenza	Angolo	Controllo	Lumen	CCT	Finitura	Codice	€
12W	30°	On-Off	1050 lm	3000 K	Bianco	282879	145
					Nero	257747	145
			Nero	321653	145		
		1-10V	1050 lm	3000 K	Bianco	303598	155
					Nero	303574	155
			DALI	1050 lm	3000 K	Bianco	286327
					Nero	286310	185

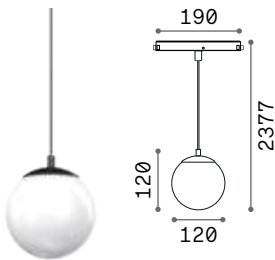

0,900 Kg/0,0125 m³

LED COBCITIZEN

Potenza	Angolo	Controllo	Lumen	CCT	Finitura	Codice	€
10W	-	On-Off	1050 lm	3000 K	Bianco	327532	130
					Nero	327525	130



Light beam: ACCENT



Light beam: WIDE

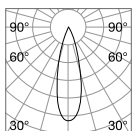

m	lx	Øm
1	2877	0,51
2	719	1,00
3	320	1,50
4	180	2,10
5	115	2,60

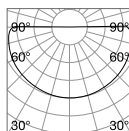

CRI≥90 12W 30° 1050lm 3000K

CRI≥90 10W 1050lm 3000K



Ego - Low



TRACK LOW Kit di montaggio non necessario, fissaggio diretto a soffitto
Lunghezza massima per punto di alimentazione: 25 metri

Lunghezza	Peso	Volume	Finitura	Codice	€
1000 mm	0,68 Kg	0,0013 m ³	Bianco	282909	45
			Nero	257877	45
2000 mm	1,36 Kg	0,0026 m ³	Bianco	282916	95
			Nero	266121	95

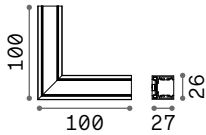

CONNECTOR HORIZONTAL LOW Optional

Peso	Volume	Controllo	Finitura	Codice	€
0,21 Kg	0,0009 m ³	On-Off	Bianco	282848	95
			Nero	257990	95
		1-10V / DALI	Bianco	286266	100
			Nero	286259	100

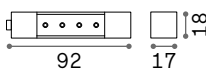

LINEAR CONNECTOR Necessario - 1 Kit x giunzione lineare

Peso	Volume	Controllo	Finitura	Codice	€
0,16 Kg	0,0005 m ³	On-Off	Bianco	285993	40
			Nero	283104	40
		1-10V / DALI	Bianco	285993	40
			Nero	283104	40

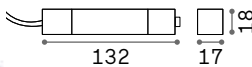

MAIN CONNECTOR Necessario - 1 Kit x punto di alimentaz. max 210W

Peso	Volume	Controllo	Finitura	Codice	€
0,12 Kg	0,0007 m ³	On-Off	Bianco	282862	36
			Nero	265896	36
		1-10V / DALI	Bianco	286303	50
			Nero	286297	50

Lunghezza cavo 2000 mm



END CAP NO HOLE



END CAP WITH HOLE



SUSPENSION KIT



KIT SINGLE CABLE



BLINDED COVER

Necessario	Misura (L x H x P)	Finitura	Codice	€
SI	26 x 11 x 27 mm	Bianco	282688	6
		Nero	267241	6
SI	26 x 11 x 27 mm	Bianco	282671	6
		Nero	267258	6
SI - 1 kit x punto di alimentaz. max 210W	2000 mm	Bianco	282749	55
		Nero	276328	55
SI - 1 kit x 900 mm	2000 mm	Bianco	282756	17
		Nero	259376	17
No	1000 x 17 x 18 mm	Bianco	344751	10 <small>new</small>
		Nero	344768	10 <small>new</small>

Ego - Assembly plans

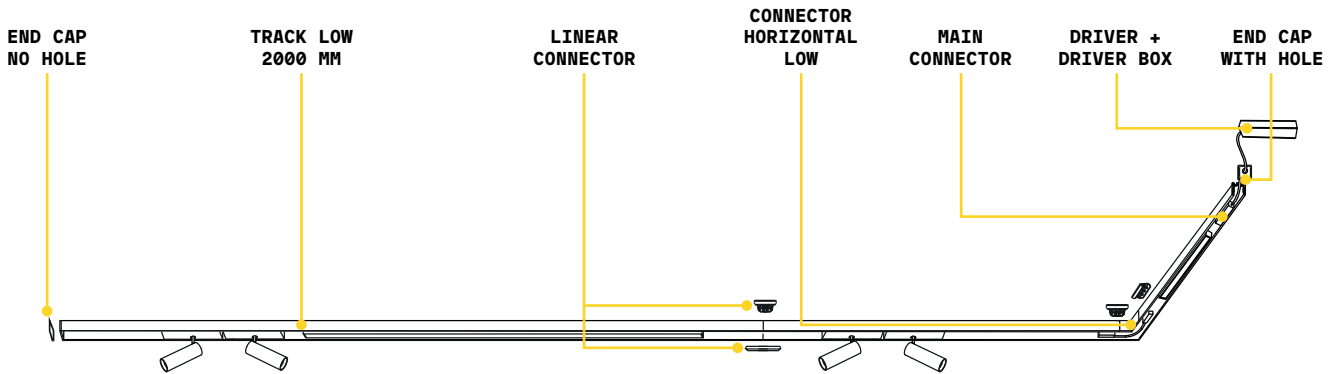
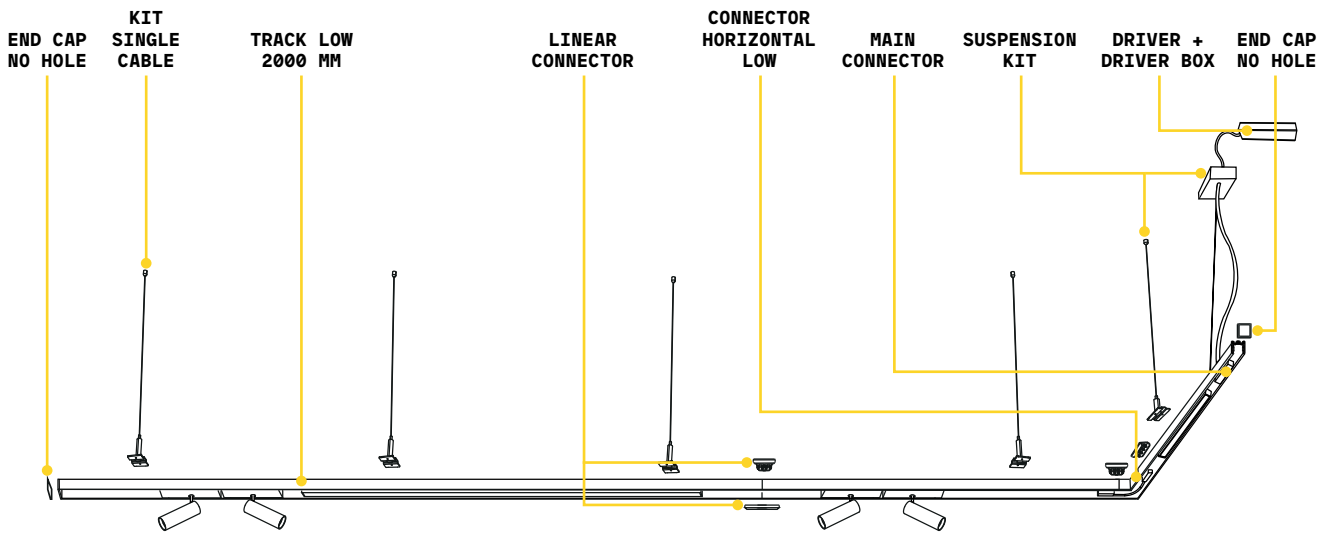

PROFILE LOW



Ego - High

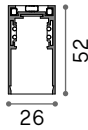

TRACK HIGH Kit di montaggio non necessario, fissaggio diretto a soffitto
Lunghezza massima per punto di alimentazione: 25 metri

Lunghezza	Peso	Volume	Finitura	Codice	€
1000 mm	0,90 Kg	0,0023 m ³	Bianco	282886	50
			Nero	258027	50
2000 mm	1,80 Kg	0,0046 m ³	Bianco	282893	120
			Nero	266145	120

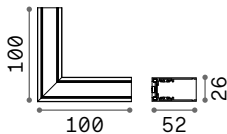

CONNECTOR HORIZONTAL HIGH Optional

Peso	Volume	Controllo	Finitura	Codice	€
0,26 Kg	0,0013 m ³	On-Off	Bianco	282824	90
			Nero	258140	90
		1-10V / DALI	Bianco	286228	100
			Nero	286211	100

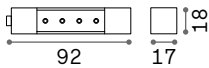

LINEAR CONNECTOR Necessario - 1 Kit x giunzione lineare

Peso	Volume	Controllo	Finitura	Codice	€
0,16 Kg	0,0005 m ³	On-Off	Bianco	285993	40
			Nero	283104	40
		1-10V / DALI	Bianco	285993	40
			Nero	283104	40

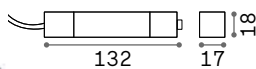

Lunghezza cavo 2000 mm

MAIN CONNECTOR Necessario - 1 Kit x punto di alimentaz. max 210W

Peso	Volume	Controllo	Finitura	Codice	€
0,12 Kg	0,0007 m ³	On-Off	Bianco	282862	36
			Nero	265896	36
		1-10V / DALI	Bianco	286303	50
			Nero	286297	50



END CAP NO HOLE

END CAP WITH HOLE

SUSPENSION KIT

KIT SINGLE CABLE

BLINDED COVER

Necessario	Misura (L x H x P)	Finitura	Codice	€
SI	26 x 11 x 52 mm	Bianco	282664	6
		Nero	267227	6
SI	26 x 11 x 52 mm	Bianco	282657	6
		Nero	267234	6
SI - 1 kit x punto di alimentaz. max 210W	2000 mm	Bianco	282749	55
		Nero	276328	55
SI - 1 kit x 900 mm	2000 mm	Bianco	282756	17
		Nero	259376	17
No	1000 x 5 x 24 mm	Bianco	282770	17
		Nero	258256	17

Ego - Assembly plans

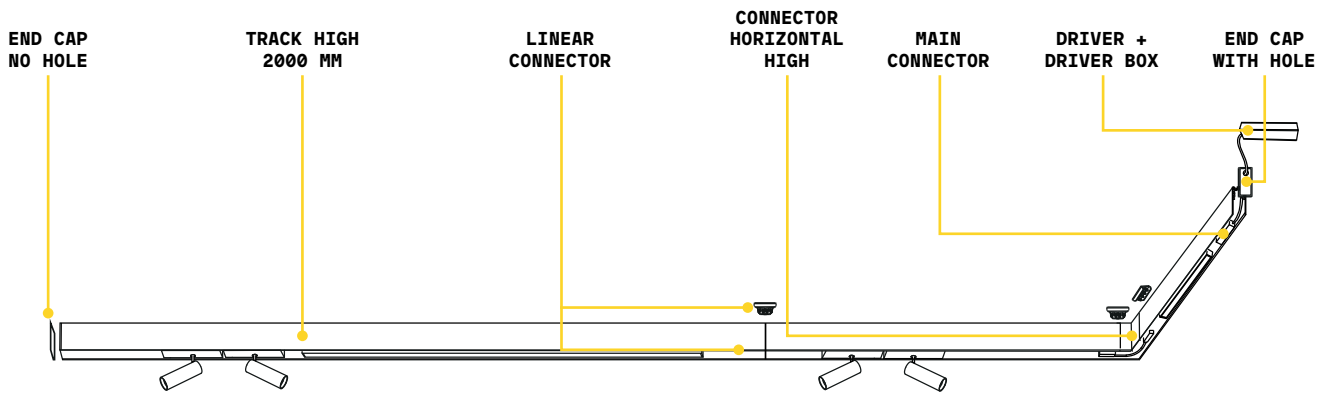
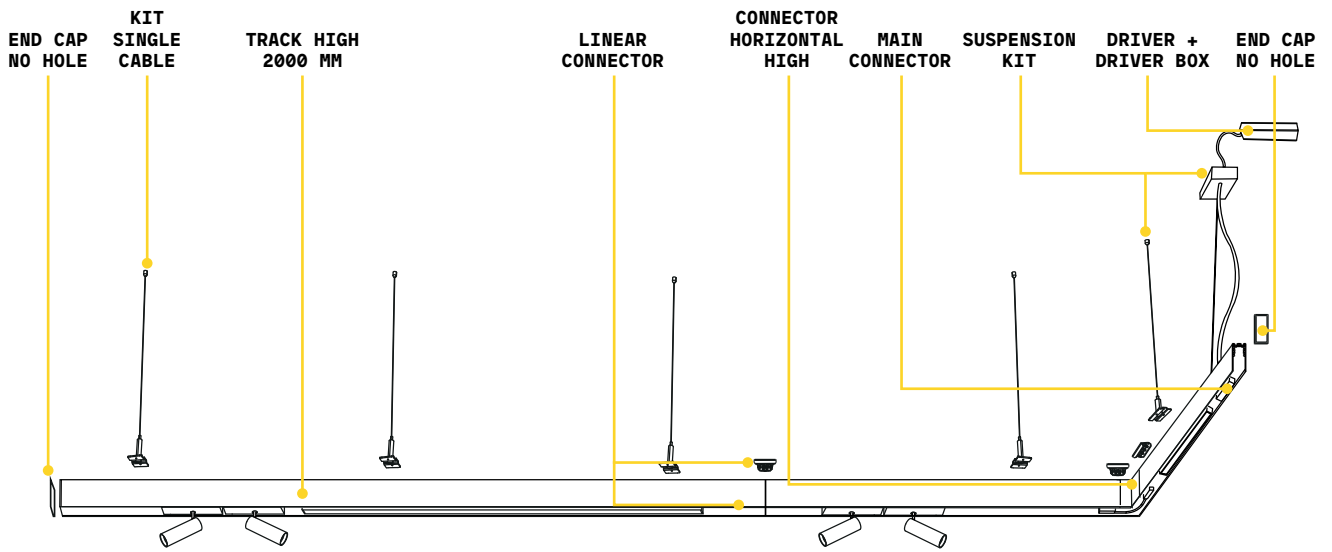

PROFILE HIGH



Ego - Recessed

TRACK Kit per montaggio profilo incluso

Lunghezza massima per punto di alimentazione: 25 metri

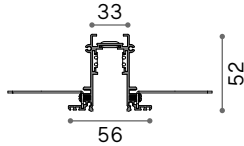

Lunghezza	Peso	Volume	Finitura	Codice	€
1000 mm	1,52 Kg	0,0039 m ³	Bianco	282923	70
			Nero	258171	70
2000 mm	2,94 Kg	0,0078 m ³	Bianco	282930	150
			Nero	266183	150

CONNECTOR HORIZONTAL Optional

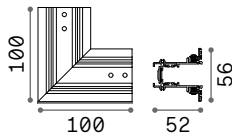

Peso	Volume	Controllo	Finitura	Codice	€
0,32 Kg	0,0013 m ³	On-Off	Bianco	282787	90
			Nero	258232	90
		1-10V / DALI	Bianco	286204	125
			Nero	286167	125

LINEAR CONNECTOR Necessario - 1 Kit x giunzione lineare

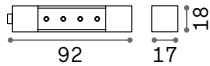

Peso	Volume	Controllo	Finitura	Codice	€
0,16 Kg	0,0007 m ³	On-Off	Bianco	283111	40
			Nero	286006	40
		1-10V / DALI	Bianco	283111	40
			Nero	286006	40

MAIN CONNECTOR Necessario - 1 Kit x punto di alimentaz. max 210W

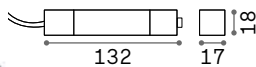

Lunghezza cavo 2000 mm

Peso	Volume	Controllo	Finitura	Codice	€
0,12 Kg	0,0005 m ³	On-Off	Bianco	282862	36
			Nero	265896	36
		1-10V / DALI	Bianco	286303	50
			Nero	286297	50



END CAP NO HOLE

END CAP WITH HOLE

BLINDED COVER

INSTALLATION TOOL

Necessario	Misura (L x H x P)	Finitura	Codice	€
SI	36 x 4 x 52 mm	Bianco	282701	6
		Nero	267203	6
SI	36 x 4 x 52 mm	Bianco	282695	6
		Nero	267210	6
No	1000 x 5 x 24 mm	Bianco	282770	17
		Nero	258256	17
No		Nero	292922	31

Ego - Assembly plans

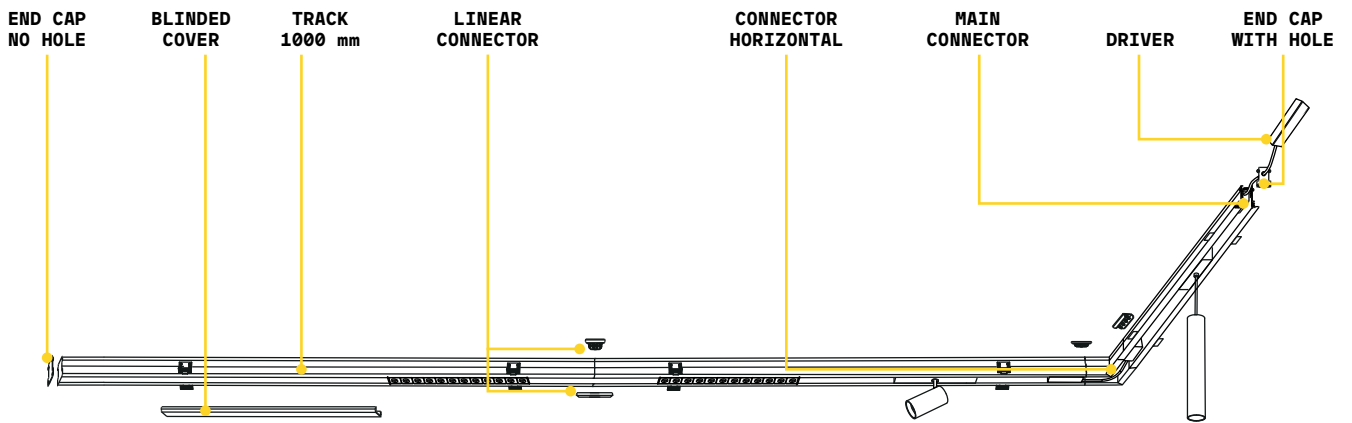

BLINDED COVER



RECESSED INSTALLATION TOOL



Ego - Recessed Easy

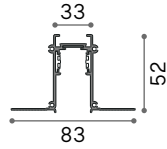

TRACK Kit di montaggio non necessario, fissaggio diretto a soffitto
Lunghezza massima per punto di alimentazione: 25 metri

Lunghezza	Peso	Volume	Finitura	Codice	€
1000 mm	1,16 Kg	0,0058 m ³	Bianco	320489	65
			Nero	320472	65
2000 mm	2,40 Kg	0,0122 m ³	Bianco	320502	130
			Nero	320496	130

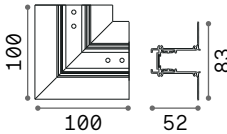

CONNECTOR HORIZONTAL Optional

Peso	Volume	Controllo	Finitura	Codice	€
0,30 Kg	0,0010 m ³	On-Off	Bianco	320748	115
			Nero	320731	115
		1-10V / DALI	Bianco	320724	135
			Nero	320717	135

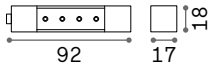

LINEAR CONNECTOR Necessario - 1 Kit x giunzione lineare

Peso	Volume	Controllo	Finitura	Codice	€
0,16 Kg	0,0005 m ³	On-Off	Bianco	283111	40
			Nero	286006	40
		1-10V / DALI	Bianco	283111	40
			Nero	286006	40

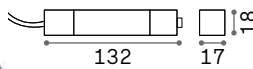

MAIN CONNECTOR Necessario - 1 Kit x punto di alimentaz. max 210W

Lunghezza cavo 2000 mm

Peso	Volume	Controllo	Finitura	Codice	€
0,12 Kg	0,0007 m ³	On-Off	Bianco	282862	36
			Nero	265896	36
		1-10V / DALI	Bianco	286303	50
			Nero	286297	50



END CAP NO HOLE

END CAP WITH HOLE

BLINDED COVER

Necessario	Misura (L x H x P)	Finitura	Codice	€
SI	83x52x30 mm	Bianco	320564	6
		Nero	320557	6
SI	83x52x30 mm	Bianco	320588	6
		Nero	320571	6
No	1000x5x24 mm	Bianco	282770	17
		Nero	258256	17

Ego - Assembly plans

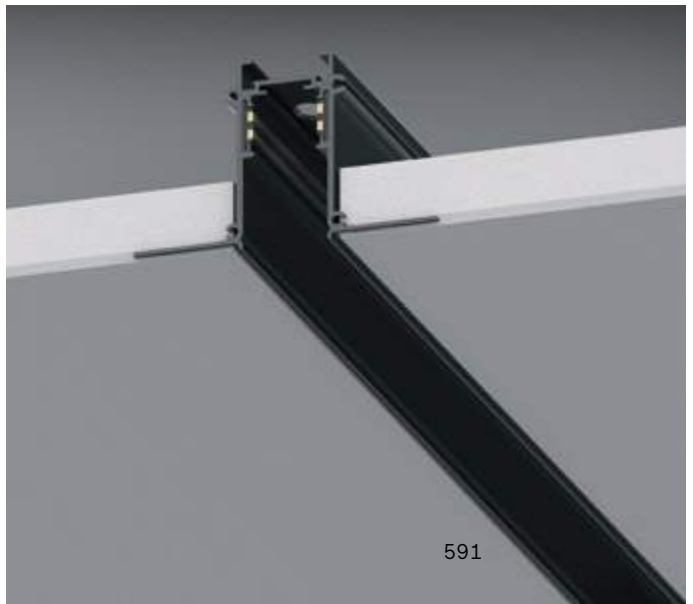
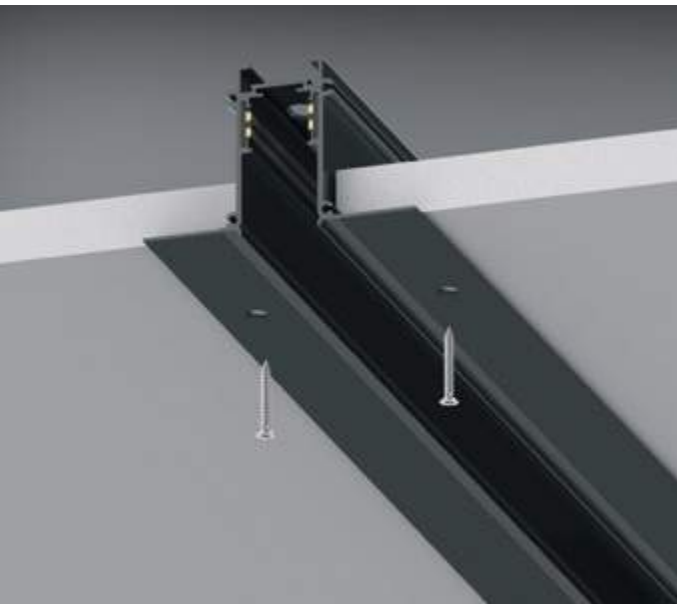
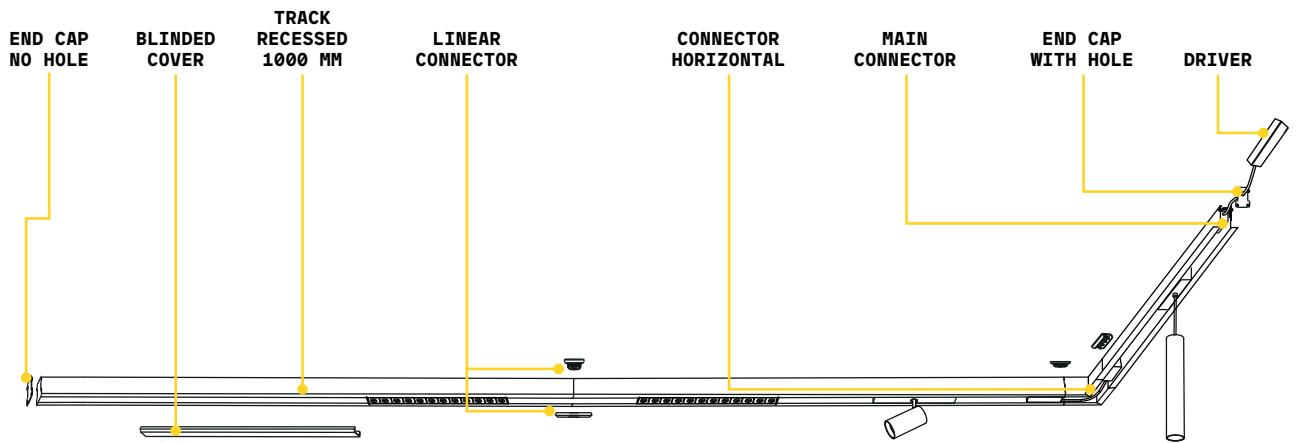

Ego - Recessed Trim

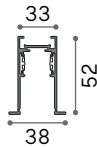

TRACK Kit per montaggio profilo incluso

Lunghezza massima per punto di alimentazione: 25 metri

Lunghezza	Peso	Volume	Finitura	Codice	€
1000 mm	1,13 Kg	0,0058 m ³	Bianco	320441	85
			Nero	320434	85
2000 mm	2,25 Kg	0,0122 m ³	Bianco	320465	170
			Nero	320458	170

CONNECTOR HORIZONTAL Optional

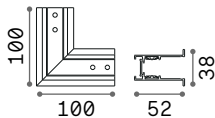

Peso	Volume	Controllo	Finitura	Codice	€
0,30 Kg	0,0010 m ³	On-Off	Bianco	320625	125
			Nero	320618	125
		1-10V / DALI	Bianco	320601	145
			Nero	320595	145

LINEAR CONNECTOR Necessario - 1 Kit x giunzione lineare

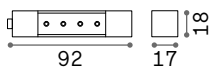

Peso	Volume	Controllo	Finitura	Codice	€
0,16 Kg	0,0005 m ³	On-Off	Bianco	283111	40
			Nero	286006	40
		1-10V / DALI	Bianco	283111	40
			Nero	286006	40

MAIN CONNECTOR Necessario - 1 Kit x punto di alimentaz. max 210W

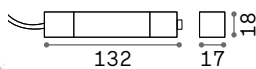

Lunghezza cavo 2000 mm

Peso	Volume	Controllo	Finitura	Codice	€
0,12 Kg	0,0007 m ³	On-Off	Bianco	282862	36
			Nero	265896	36
		1-10V / DALI	Bianco	286303	50
			Nero	286297	50



END CAP NO HOLE

END CAP WITH HOLE

BLINDED COVER

Necessario	Misura (L x H x P)	Finitura	Codice	€
SI	38 x 52 x 17 mm	Bianco	320526	6
		Nero	320519	6
SI	38 x 52 x 17 mm	Bianco	320540	6
		Nero	320533	6
No	1000 x 5 x 24 mm	Bianco	282770	17
		Nero	258256	17

Ego - Assembly plans

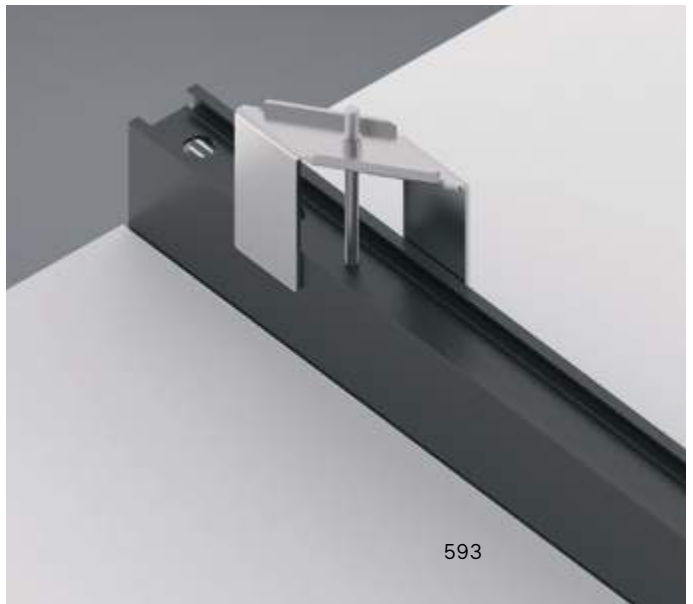
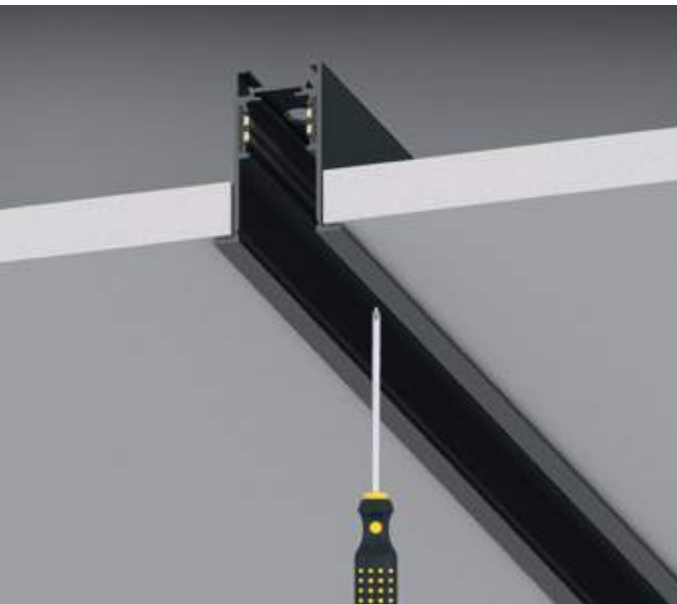
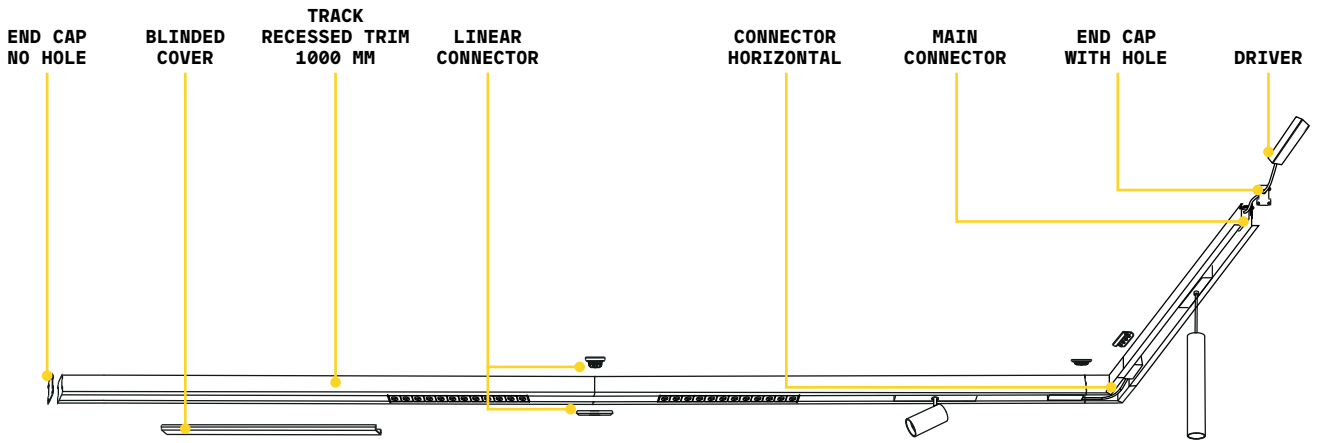

Ego - Bi-Emission

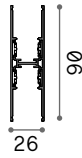

TRACK BI-EMISSION Lunghezza massima per punto di alimentazione: 13 metri

Lunghezza	Peso	Volume	Finitura	Codice	€
1000 mm	1,40 Kg	0,0058 m ³	Nero	322513	145 <small>new</small>
2000 mm	2,90 Kg	0,0080 m ³	Nero	340647	290 <small>new</small>

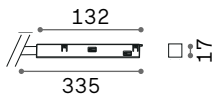

BI-EMISSION LINEAR CONNECTOR Necessario - 1 Kit x giunzione lineare

Peso	Volume	Controllo	Finitura	Codice	€
0,271 Kg	0,0032 m ³	On-Off	Nero	339863	215 <small>new</small>
		1-10V / DALI	Nero	351346	240 <small>new</small>

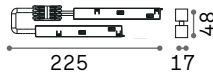

BI-EMISSION UP/DOWN ELECTRICAL CONNECTOR Necessario - 1 Kit x giunzione lineare

Peso	Volume	Controllo	Finitura	Codice	€
0,100 Kg	0,0016 m ³	On-Off	Nero	322810	70 <small>new</small>
		1-10V / DALI	Nero	342757	80 <small>new</small>

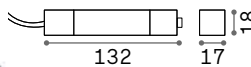

Lunghezza cavo 2000 mm

MAIN CONNECTOR Necessario - 1 Kit x punto di alimentaz. max 210W

Peso	Volume	Controllo	Finitura	Codice	€
0,12 Kg	0,0005 m ³	On-Off	Bianco	282862	36
			Nero	265896	36
		1-10V / DALI	Bianco	286303	50
			Nero	286297	50



END CAP NO HOLE

END CAP WITH HOLE

SUSPENSION KIT

KIT SINGLE CABLE

BLINDED COVER

Necessario	Misura (L x H x P)	Finitura	Codice	€
SI	26 x 90 x 2 mm	Nero	322841	6 <small>new</small>
SI	26 x 90 x 2 mm	Nero	322858	6 <small>new</small>
SI - 1 kit x punto di alimentaz. max 210W	2100 mm	Nero	322476	55 <small>new</small>
SI - 1 kit x 900 mm	2085 mm	Nero	322490	35 <small>new</small>
No	1000 x 5 x 24 mm	Nero	258256	17

Ego - Assembly plans

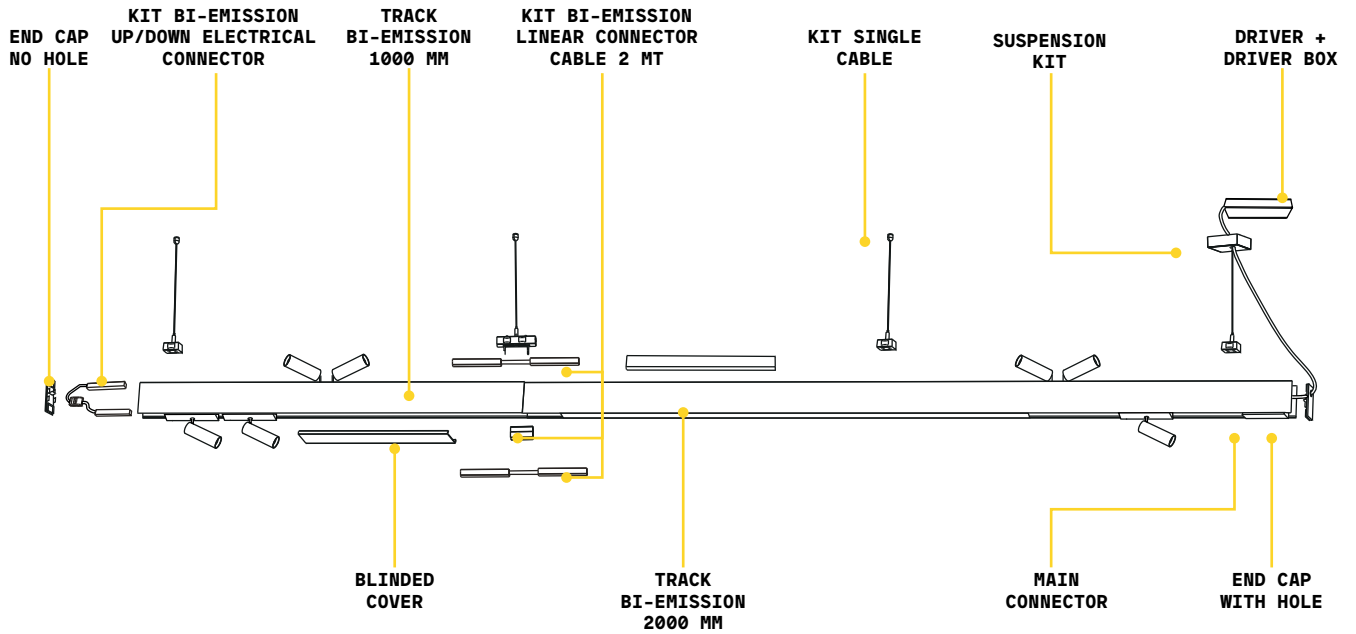

Ego - Drivers



DRIVER MEANWELL ON/OFF Necessario

Potenza	Output	Classe	Misura (L x H x P)	Driver box	Codice	€
75 W	48 Vdc	⊕	171x37x62 mm	255x55x75 mm	223155	140
96 W	48 Vdc	⊕	220x37x68 mm	330x60x80 mm	223162	185
150 W	48 Vdc	⊕	228x37x68 mm	330x60x80 mm	223179	205
240 W	48 Vdc	⊕	244x39x68 mm	330x60x80 mm	224275	230



DRIVER BOX Optional

Materiale	Misura (L x H x P)	Colore	Codice	€
Metal	255x55x75 mm	Bianco	302379	25
		Nero	302362	25
	330x60x80 mm	Bianco	302355	30
		Nero	302348	30



MAGNETIC DRIVER Necessario - Lunghezza cavo 2000 mm Sostituisce Driver + Main Connector*

Potenza	Output	Classe	Misura (L x H x P)	Codice	€
100 W	48 Vdc	□	297x20x16 mm	296302	90
150 W	48 Vdc	□	268x43x16 mm	325750	95
250 W	48 Vdc	□	268x43x16 mm	325767	110

* Codici **325750** e **325767** consigliati per l'impiego nelle versioni HIGH e RECESSED.



Stick new

Sistema lineare dimmerabile composto da un profilo in alluminio estruso ed elementi di illuminazione a fissaggio magnetico. Il sistema è disponibile in colore nero opaco nella modalità d'installazione a plafone (SURFACE) o incasso a scomparsa nel cartongesso (RECESSED). Sezione ridotta del profilo larga 19 mm e alta soltanto 13.5 mm, disponibile in due lunghezze 1000 mm e 2000 mm. Possibilità di composizione con diversi moduli luminosi a seconda della disposizione desiderata, modificabile all'occorrenza: i moduli TRACK SINGLE e DOUBLE per un'illuminazione spot, i moduli ACCENT per una luce focalizzata e i moduli WIDE per un'illuminazione diffusa e uniforme. Tecnologia a LED integrati con temperatura di colore di 2700 K e 3000 K; elevata resa cromatica CRI \geq 90, protezione IP20, classe isolamento III, alimentazione in 48 Vdc, durata utile LED 50.000 h L70B50; sistema disponibile anche in versione dimmerabile 1-10V. Ideale per l'illuminazione di dettagli o piccoli ambienti dove viene richiesta ampia flessibilità ed elevata qualità di illuminazione, ad esempio spazi MUSEALI, RESIDENZIALI e RETAIL.

Sorgente	LED COB / SMD
Driver incluso	No
Driver disponibili	On/Off / 1-10V
Controllo	Phase-cut
CCT	2700 K / 3000 K
CRI	\geq 90
Durata LED	50.000h
Classe isolamento	III
IP	20
Materiale	Alluminio
Garanzia	5 anni



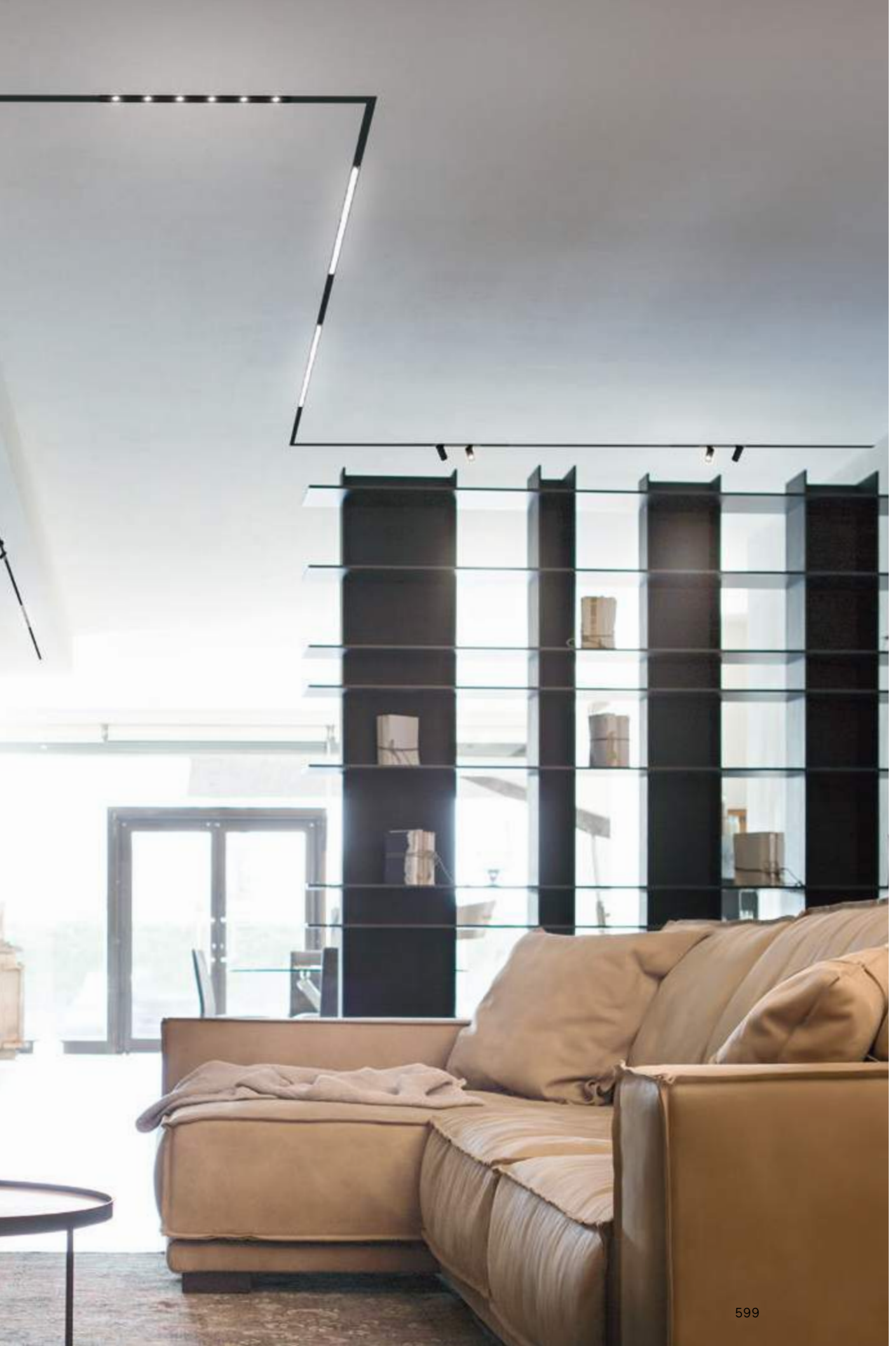

Stick Track Single

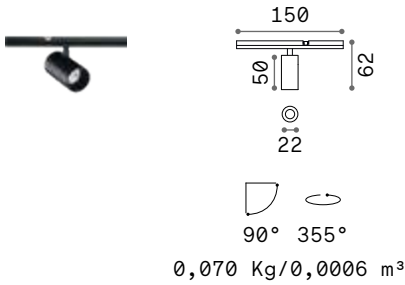

LED SMD BRIDGELUX

Potenza	Angolo	Lumen	CCT	Finitura	Codice	€
3W	24°	240 lm	2700 K	Nero	345048	45 <small>new</small>
		250 lm	3000 K	Nero	329505	45

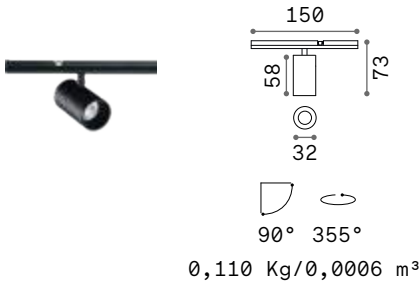

LED SMD BRIDGELUX

Potenza	Angolo	Lumen	CCT	Finitura	Codice	€
5W	30°	420 lm	2700 K	Nero	345055	50 <small>new</small>
		430 lm	3000 K	Nero	329529	50

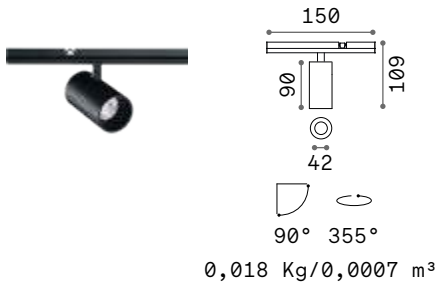

LED SMD BRIDGELUX

Potenza	Angolo	Lumen	CCT	Finitura	Codice	€
7W	36°	570 lm	2700 K	Nero	345062	90 <small>new</small>
		600 lm	3000 K	Nero	343501	90 <small>new</small>

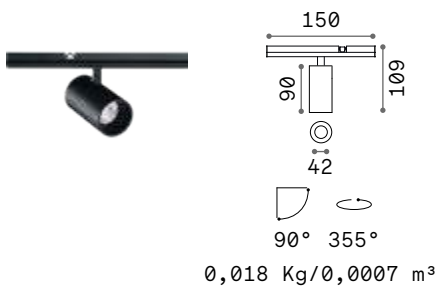

LED SMD BRIDGELUX

Potenza	Angolo	Lumen	CCT	Finitura	Codice	€
10W	36°	760 lm	2700 K	Nero	345079	95 <small>new</small>
		800 lm	3000 K	Nero	343518	95 <small>new</small>



Light beam: SPOT



Light beam: ACCENT

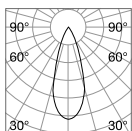

m	lx	cm
1	514	0,62
2	128	1,20
3	57	1,90
4	32	2,50
5	21	3,10



CRI≥90 3W 24° 250lm 3000K

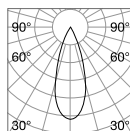

m	lx	cm
1	822	0,62
2	205	1,20
3	91	1,90
4	51	2,50
5	33	3,10



CRI≥90 5W 30° 430lm 3000K



Stick Track Double

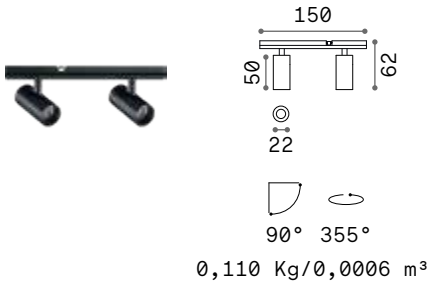

LED COB BRIDGELUX

Potenza	Angolo	Lumen	CCT	Finitura	Codice	€
6W	24°	480 lm	2700 K	Nero	345024	68 new
		500 lm	3000 K	Nero	329512	68

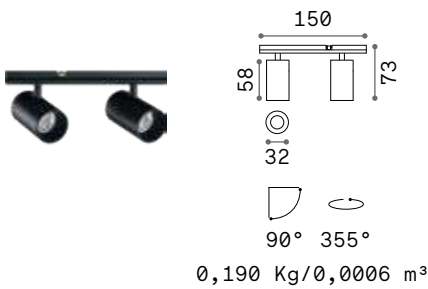

LED COB BRIDGELUX

Potenza	Angolo	Lumen	CCT	Finitura	Codice	€
10W	30°	840 lm	2700 K	Nero	345031	75 new
		870 lm	3000 K	Nero	329536	75



Light beam: SPOT



Light beam: ACCENT

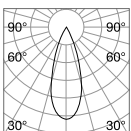

m	lx	Øm
1	1028	0,62
2	257	1,20
3	114	1,90
4	64	2,50
5	41	3,10



CRI≥90 6W 24° 500lm 3000K

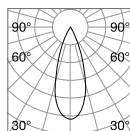

m	lx	Øm
1	1645	0,62
2	411	1,20
3	183	1,90
4	103	2,50
5	66	3,10



CRI≥90 10W 30° 870lm 3000K



Stick Accent

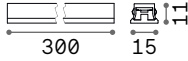

0,070 Kg/0,0001 m³

LED SMD BRIDGELUX

Potenza	Angolo	Lumen	CCT	Finitura	Codice	€
6W	40°	600 lm	2700 K	Nero	344980	30 <small>new</small>
		630 lm	3000 K	Nero	329468	30

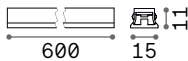

0,150 Kg/0,0002 m³

LED SMD BRIDGELUX

Potenza	Angolo	Lumen	CCT	Finitura	Codice	€
12W	40°	1200 lm	2700 K	Nero	345000	60 <small>new</small>
		1250 lm	3000 K	Nero	329475	60

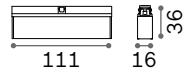

0,080 Kg/0,0004 m³

LED SMD BRIDGELUX

Potenza	Angolo	Lumen	CCT	Finitura	Codice	€
8W	40°	780 lm	2700 K	Nero	344997	45 <small>new</small>
		800 lm	3000 K	Nero	343525	45 <small>new</small>

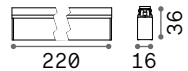

0,140 Kg/0,0006 m³

LED SMD BRIDGELUX

Potenza	Angolo	Lumen	CCT	Finitura	Codice	€
16W	40°	1550 lm	2700 K	Nero	345017	70 <small>new</small>
		1600 lm	3000 K	Nero	343532	70 <small>new</small>



Light beam: ACCENT

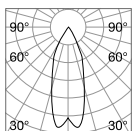

m	lx	Øm
1	958	0,64
2	240	1,30
3	106	1,90
4	60	2,60
5	38	3,20



CRI≥90 6W 40° 630lm 3000K

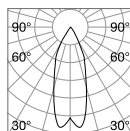

m	lx	Øm
1	1917	0,64
2	479	1,30
3	213	1,90
4	120	2,60
5	77	3,20



CRI≥90 12W 40° 1250lm 3000K



329468



329468

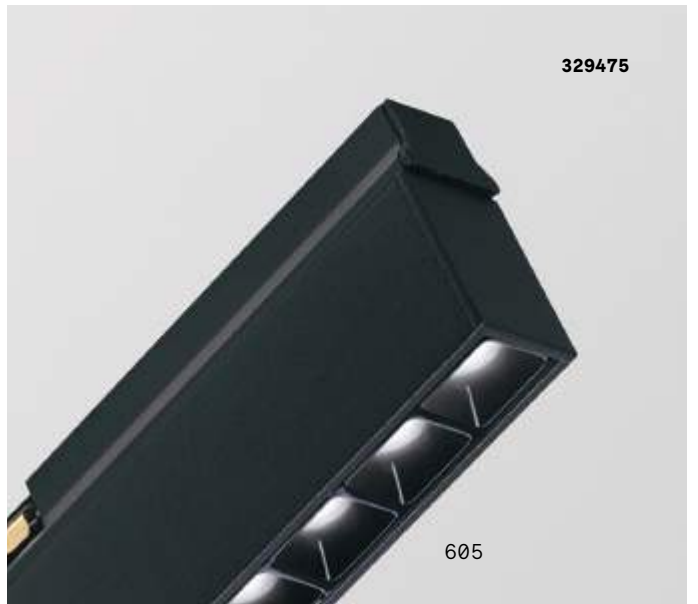

329475

605

Stick Wide



LED SMD BRIDGELUX

Potenza	Angolo	Lumen	CCT	Finitura	Codice	€
6W	110°	580 lm	2700 K	Nero	345086	25 new
		600 lm	3000 K	Nero	329444	25

0,070 Kg/0,0001 m³



LED SMD BRIDGELUX

Potenza	Angolo	Lumen	CCT	Finitura	Codice	€
12W	110°	1150 lm	2700 K	Nero	345093	50 new
		1200 lm	3000 K	Nero	329451	50

0,130 Kg/0,0002 m³



Light beam: WIDE

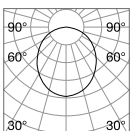

m	lx	Øm
1	138	2,50
2	35	4,90
3	15	7,40
4	8,7	9,80
5	5,5	12,00

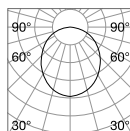
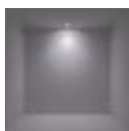

m	lx	Øm
1	277	2,50
2	69	4,90
3	31	7,40
4	17	9,80
5	11	12,00



CRI≥90 6W 110° 600lm 3000K

CRI≥90 12W 110° 1200lm 3000K



Stick Wide 300 mm



Stick Wide 600 mm



Stick Surface

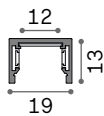

TRACK Kit per montaggio profilo e tappi di chiusura inclusi

Lunghezza	Peso	Volume	Finitura	Codice	€
1000 mm	0,350 Kg	0,0594 m ³	Nero	329574	30
2000 mm	0,700 Kg	0,1154 m ³	Nero	329581	55

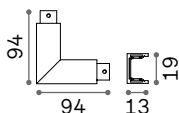

CONNECTOR HORIZONTAL Optional

Peso	Volume	Finitura	Codice	€
0,10 Kg	0,0015 m ³	Nero	330358	37



BLINDED COVER

Necessario	Misura (L x H x P)	Finitura	Codice	€
No	1000 x 3 x 16 mm	Nero	329635	4
	2000 x 3 x 16 mm	Nero	329642	6

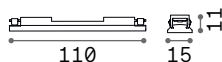

STRAIGHT CONNECTOR Necessario - 1 Kit x giunzione lineare

Peso	Volume	Finitura	Codice	€
0,03 Kg	0,0001 m ³	Nero	329710	15

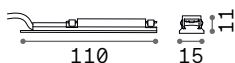

MAIN CONNECTOR Necessario - 1 Kit x punto di alimentazione

Peso	Volume	Finitura	Codice	€
0,08 Kg	0,0003 m ³	Nero	329703	20

DRIVER 1-10V Necessario



Potenza	Output	Classe	Misura (L x H x P)	Codice	€
150 W	48 Vdc	<input type="checkbox"/>	350x18x30 mm	329673	90

POWER SUPPLY LINEAR Necessario Sostituisce Driver + Main Connector



Potenza	Output	Classe	Misura (L x H x P)	Codice	€
120 W	48 Vdc	<input type="checkbox"/>	304x32x16 mm	329666	80

Lunghezza cavo 2000 mm

Stick - Assembly plans

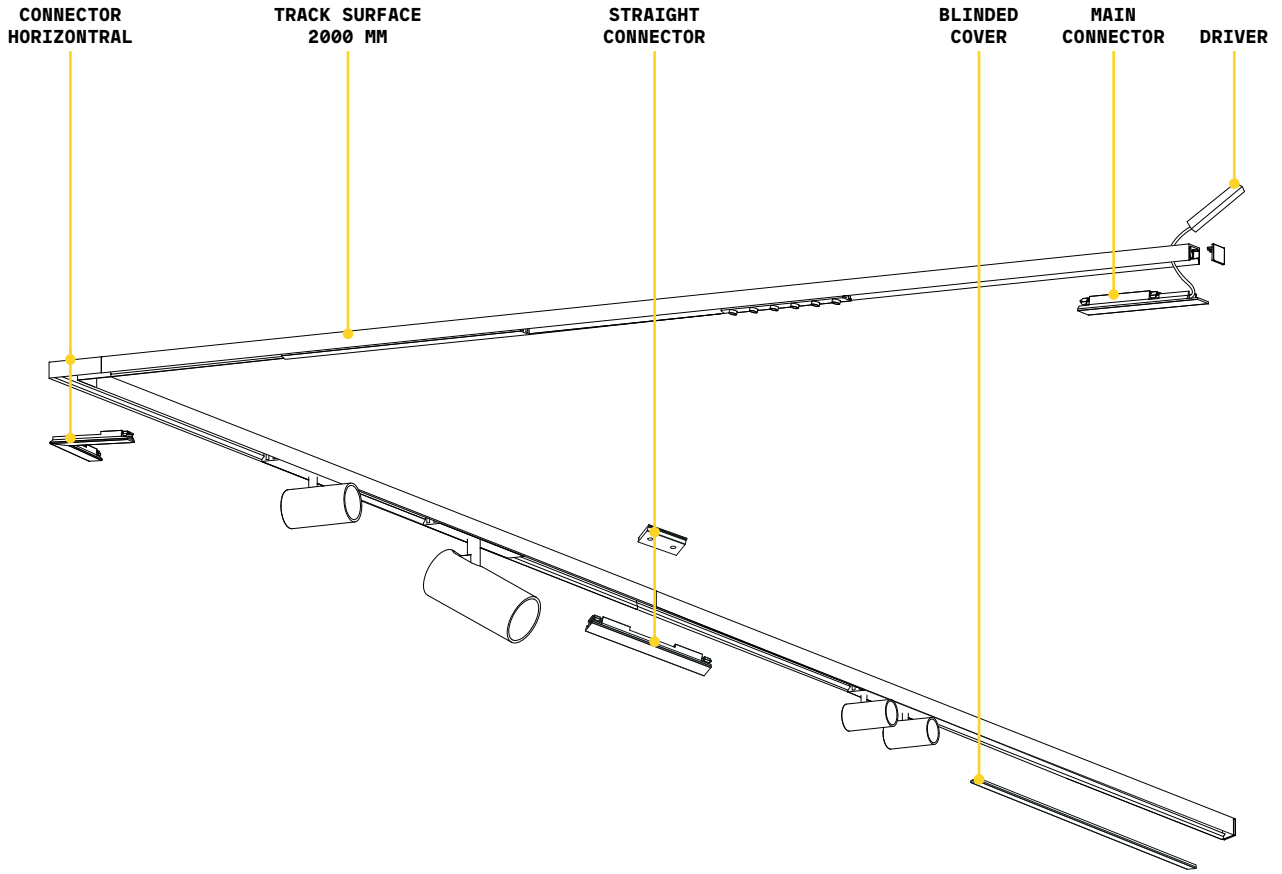

BLINDED COVER

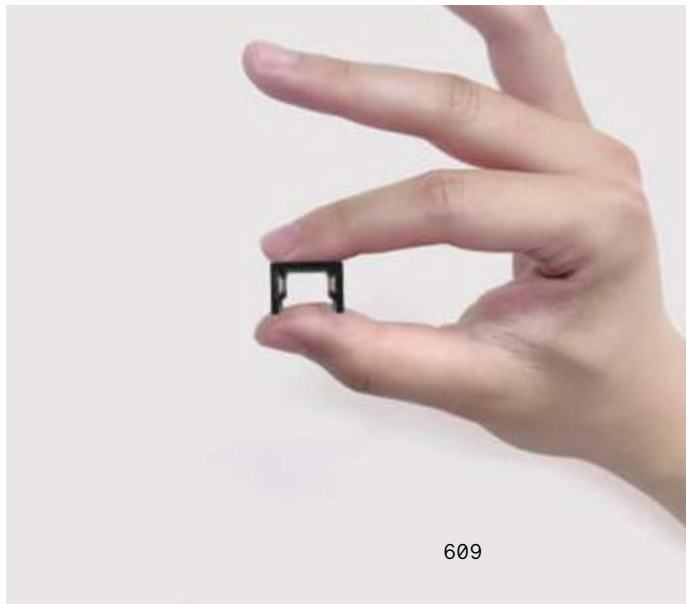

Stick Recessed

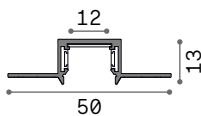

TRACK Kit per montaggio profilo e tappi di chiusura inclusi

Lunghezza	Peso	Volume	Finitura	Codice	€
1000 mm	0,400 Kg	0,0816 m ³	Nero	329598	35
2000 mm	0,800 Kg	0,1586 m ³	Nero	329604	70

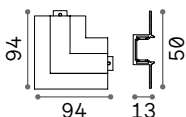

CONNECTOR HORIZONTAL Optional

Peso	Volume	Finitura	Codice	€
0,07 Kg	0,0015 m ³	Nero	330365	37



BLINDED COVER

Necessario	Misura (L x H x P)	Finitura	Codice	€
No	1000 x 3 x 16 mm	Nero	329635	4
	2000 x 3 x 16 mm	Nero	329642	6

STRAIGHT CONNECTOR Necessario - 1 Kit x giunzione lineare

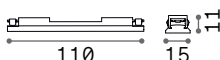

Peso	Volume	Finitura	Codice	€
0,03 Kg	0,0001 m ³	Nero	329710	15

MAIN CONNECTOR Necessario - 1 Kit x punto di alimentazione

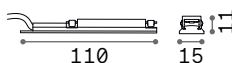

Lunghezza cavo 140 mm

Peso	Volume	Finitura	Codice	€
0,08 Kg	0,0003 m ³	Nero	329703	20

DRIVER 1-10V Necessario



Potenza	Output	Classe	Misura (L x H x P)	Codice	€
150 W	48 Vdc	<input type="checkbox"/>	350x18x30 mm	329673	90

POWER SUPPLY LINEAR Necessario - Lunghezza cavo 400 mm
Sostituisce Driver + Main Connector



Lunghezza cavo 2000 mm

Potenza	Output	Classe	Misura (L x H x P)	Codice	€
150 W	48 Vdc	<input type="checkbox"/>	304x32x16 mm	329666	80

Stick - Assembly plans

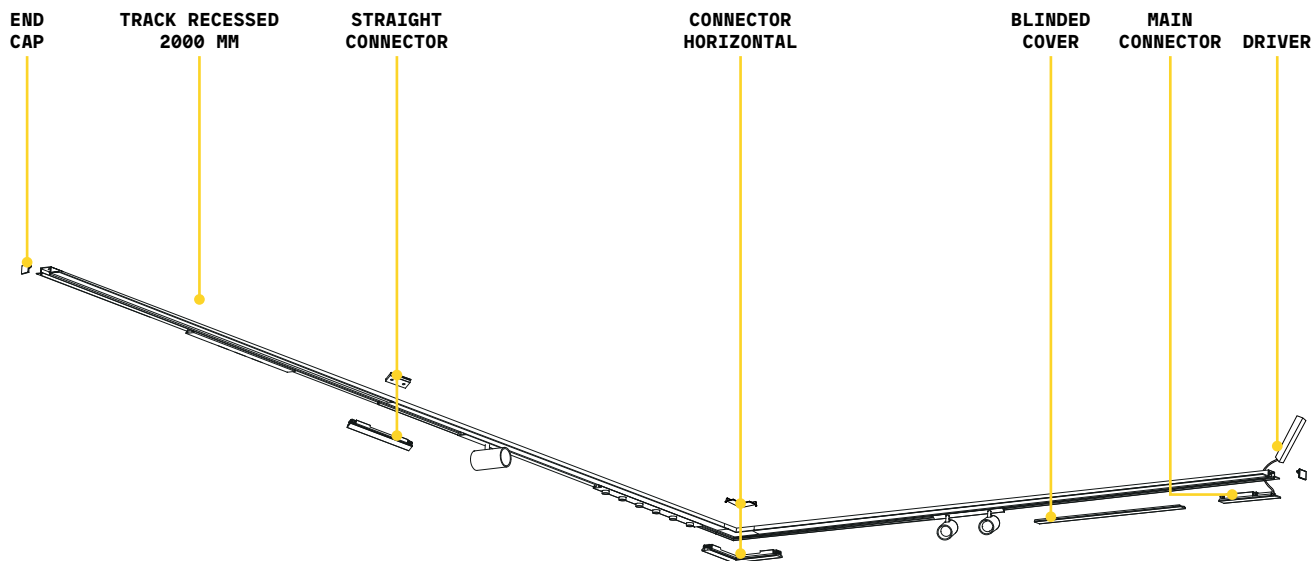

BLINDED COVER



Arca

Sistema lineare in alluminio estruso compatibile con un'ampia scelta di moduli illuminanti a fissaggio meccanico. Finitura anodizzata e verniciata, disponibile in colore nero nelle modalità d'installazione a plafone, a sospensione oppure a incasso a filo nei soffitti di cartongesso. Moduli componibili a seconda della disposizione desiderata. Profili disponibili nelle due lunghezze 1000 mm e 3000 mm. Possibilità di assemblaggio con diversi moduli sorgente: moduli WIDE diffondenti, moduli ACCENT con UGR < 13 e moduli TRACK orientabili per un'illuminazione mirata. Tecnologia LED COB o SMD, temperatura di colore di 3000 K o di 4000 K, binning iniziale \leq 3-Step MacAdam, protezione IP20, classe isolamento III, durata utile LED 50.000 h L70B50. L'alimentazione in 48 Vdc conferisce grande versatilità e sicurezza, con composizioni reversibili e modificabili all'occorrenza. Sistema adatto per ambienti dove viene richiesta un'illuminazione professionale e potente dal design minimale, come ad esempio UFFICI e spazi COMMERCIALI.

PRO

Prodotto ad alto contenuto tecnologico, elevata qualità dei materiali, destinato ad uso professionale.

UGR

Articolo con UGR <13 (Accent).

Sorgente	LED COB / SMD
Driver incluso	No
Driver disponibili	On/Off
MacAdam	SDCM 3
CCT	3000 K / 4000 K
CRI	\geq 90
UGR	<13 (Accent)
Durata LED	50.000h
Classe isolamento	III
IP	20
Materiale	Alluminio
Garanzia	5 anni





Arca Track

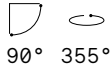
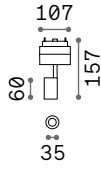

0,200 Kg/0,0015 m³

LED SMD CREE

Potenza	Angolo	Lumen	CCT	Finitura		Codice	€
5W	34°	430 lm	3000 K	Nero	■	222974	109
		450 lm	4000 K	Nero	■	223056	109

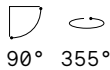
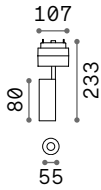

0,460 Kg/0,0030 m³

LED COB CITIZEN

Potenza	Angolo	Lumen	CCT	Finitura		Codice	€
14W	36°	1250 lm	3000 K	Nero	■	222967	140
		1300 lm	4000 K	Nero	■	223049	140



Light beam: ACCENT

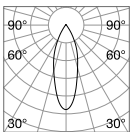

m	lx	cm
1	553	0,58
2	138	1,16
3	61	1,75
4	35	2,33
5	22	2,91

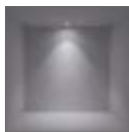

CRI≥90 5W 34° 430lm 3000K

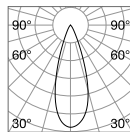

m	lx	cm
1	2336	0,60
2	584	1,21
3	259	1,81
4	146	2,42
5	93	3,02

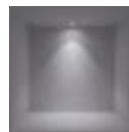

CRI≥90 14W 36° 1250lm 3000K



Arca Accent

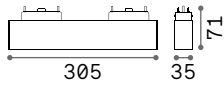

LED SMD OSRAM UGR <13

Potenza	Angolo	Lumen	CCT	Finitura		Codice	€
15W	35°	1600 lm	3000 K	Nero	■	222929	170
		1650 lm	4000 K	Nero	■	223001	170

0,440 Kg/0,0026 m³

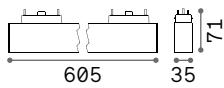

LED SMD OSRAM UGR <13

Potenza	Angolo	Lumen	CCT	Finitura		Codice	€
29W	35°	3200 lm	3000 K	Nero	■	222936	300
		3350 lm	4000 K	Nero	■	223018	300

0,700 Kg/0,0087 m³



Light beam: ACCENT

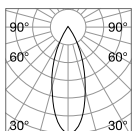

m	lx	Øm
1	2707	0,56
2	676	1,13
3	300	2,26
4	169	2,83
5	108	3,39

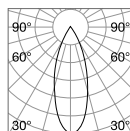

m	lx	Øm
1	4826	0,60
2	1207	1,21
3	536	1,81
4	301	2,42
5	193	3,02



CRI≥90 15W 35° 16001m 3000K

CRI≥90 29W 35° 32001m 3000K

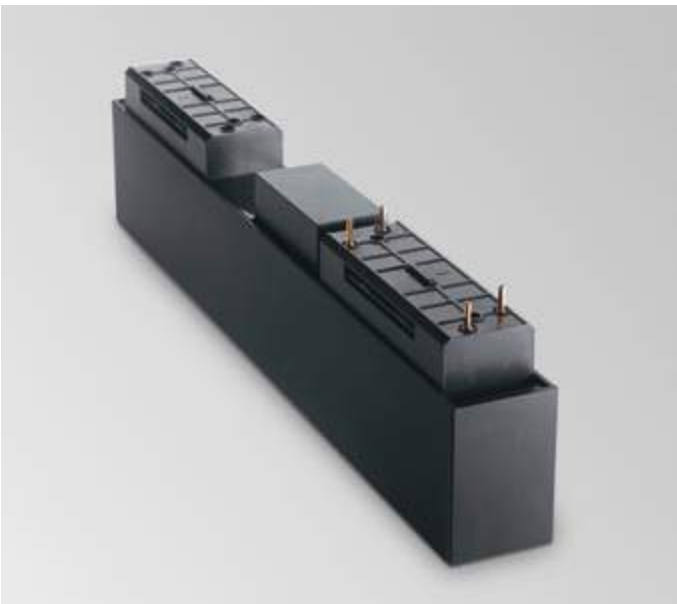

Arca Accent 300 mm



Arca Accent 600 mm



Arca Wide

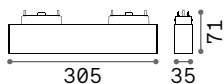
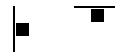

LED SMD SAMSUNG

Potenza	Angolo	Lumen	CCT	Finitura	Codice	€
13W	98°	1550 lm	3000 K	Nero	222943	105
		1650 lm	4000 K	Nero	223025	105

0,410 Kg/0,0025 m³

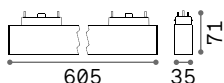

LED SMD SAMSUNG

Potenza	Angolo	Lumen	CCT	Finitura	Codice	€
25W	98°	3100 lm	3000 K	Nero	222950	152
		3300 lm	4000 K	Nero	223032	152

0,700 Kg/0,0087 m³



Light beam: WIDE

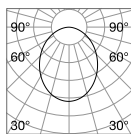

m	lx	Øm
1	203	2,16
2	50	4,33
3	22	6,50
4	12	8,66
5	8	10,83

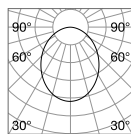
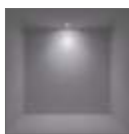

m	lx	Øm
1	440	2,14
2	110	4,28
3	48	6,42
4	27	8,56
5	17	10,70

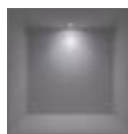

CRI≥90 13W 98° 1550lm 3000K

CRI≥90 25W 98° 3100lm 3000K



Arca Wide 300 mm



Arca Wide 600 mm



Arca - Suspension

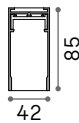
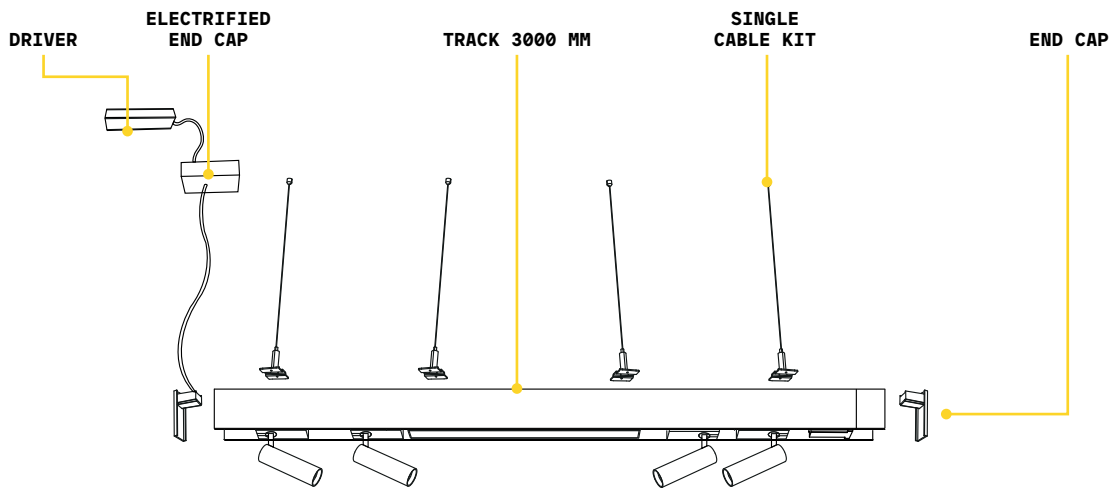

TRACK Lunghezza massima per punto di alimentazione: 25 metri

Lunghezza	Peso	Volume	Finitura	Codice	€
1000 mm	1,34 Kg	0,0273 m ³	Nero	■ 222745	120
3000 mm	4,02 Kg	0,0496 m ³	Nero	■ 222752	325



	Necessario	Lunghezza cavi	Misura (L x H x P)	Codice	€
LINEAR CONNECTOR	SI - 1 Kit x giunzione		100 x 18 x 38 mm	254944	25
END CAP	SI		20 x 85 x 42 mm	223148	18
SINGLE CABLE KIT	SI - 1 Kit x 1000 mm	2000 mm	ø 15 x 2000 mm	276366	14

Arca - Surface

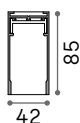
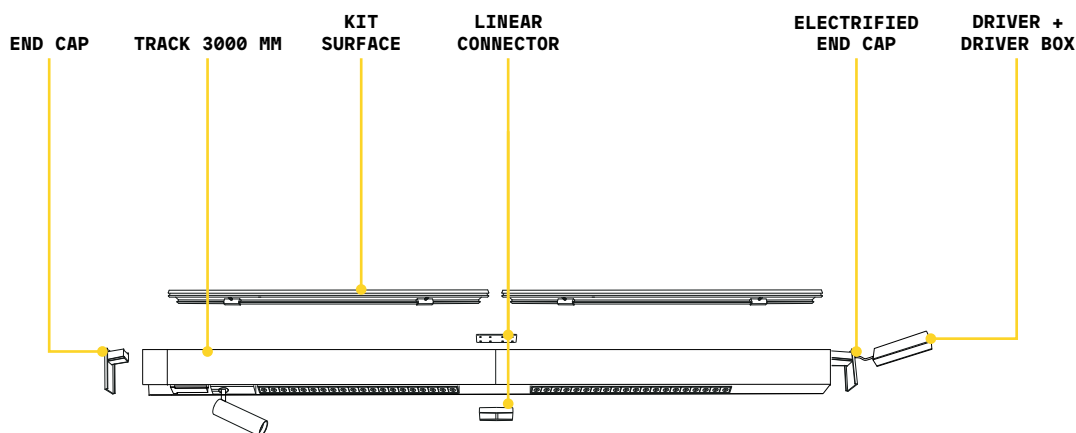

TRACK Lunghezza massima per punto di alimentazione: 25 metri

Lunghezza	Peso	Volume	Finitura	Codice	€
1000 mm	1,34 Kg	0,0273 m ³	Nero	222745	120
3000 mm	4,02 Kg	0,0496 m ³	Nero	222752	325



	Necessario	Lunghezza cavi	Misura (L x H x P)	Codice	€
LINEAR CONNECTOR	SI - 1 Kit x giunzione		100 x 18 x 38 mm	254944	25
ELECTRIFIED END CAP	SI - 1 kit x punto di alimentaz. max 210W	380 mm	86 x 80 x 42 mm	223124	24
END CAP	SI		20 x 85 x 42 mm	223148	18
KIT SURFACE	SI - 1 Kit x 1000 mm		1000 x 12 x 42 mm	222899	30

Arca - Recessed

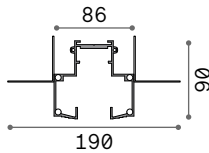
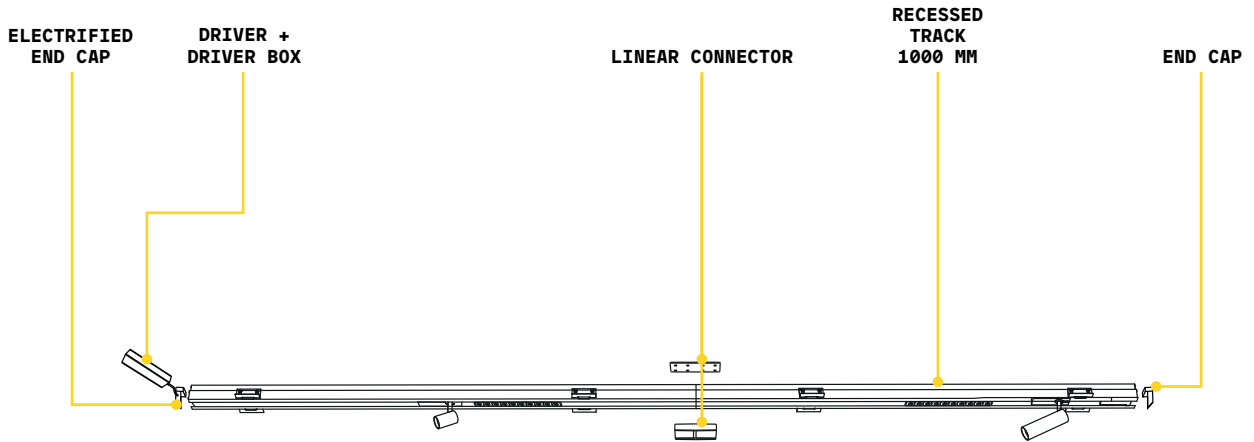

TRACK Kit per montaggio profilo e tappi di chiusura inclusi
Lunghezza massima per punto di alimentazione: 25 metri

Lunghezza	Peso	Volume	Finitura	Codice	€
1000 mm	2,90 Kg	0,0269 m ³	Nero	222769	187
3000 mm	8,70 Kg	0,0496 m ³	Nero	222882	490



	Necessario	Lunghezza cavi	Misura (L x H x P)	Codice	€
LINEAR CONNECTOR	SI - 1 Kit x giunzione		100 x 18 x 38 mm	254944	25
ELECTRIFIED END CAP	SI - 1 kit x punto di alimentaz. max 210W	380 mm	86 x 80 x 42 mm	223124	24



Arca - Drivers and cover

DRIVER MEANWELL ON/OFF Necessario



Potenza	Output	Classe	Misura (L x H x P)	Driver box	Codice	€
75 W	48 Vdc	⊕	171x37x62 mm	255x55x75 mm	223155	140
96 W	48 Vdc	⊕	220x37x68 mm	330x60x80 mm	223162	185
150 W	48 Vdc	⊕	228x37x68 mm	330x60x80 mm	223179	205
240 W	48 Vdc	⊕	244x39x68 mm	330x60x80 mm	224275	230

DRIVER BOX Optional



Materiale	Misura (L x H x P)	Colore	Codice	€
Metal	255x55x75 mm	Bianco	302379	25
		Nero	302362	25
	330x60x80 mm	Bianco	302355	30
		Nero	302348	30

BLINDED COVER Optional



Materiale	Lunghezza	Colore	Codice	€
PC	990 mm	Nero	222912	8

Linus



Lampada lineare in alluminio con illuminazione diretta e indiretta. La lampada è modulare e può essere proposta singolarmente oppure in linea continua. LED integrati; binning iniziale ≤ 3-Step MacAdam; CRI ≥ 90; protezione IP20, classe isolamento I. Alimentatore dimmerabile 1-10V integrato di serie.

Sorgente	LED SMD	Durata LED	50.000 h
Potenza	32W	Classe	I
Driver incluso	1-10V	isolamento	
Driver disponibili	No	IP	20
MacAdam	SDCM 3	Materiale	Alluminio
CCT	3000 K/ 4000 K	Garanzia	5 anni
CRI	≥90		

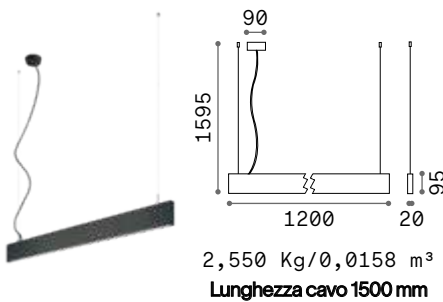

LED SMD Up-light inclusa - Driver 1-10V incluso

Potenza	Angolo	Lumen	CCT	Finitura	Codice	€
32W	104°	1500 lm	3000 K	Bianco	241968	220
				Nero	241975	220
		1750 lm	4000 K	Bianco	268231	220
				Nero	268217	220

UP-LIGHT INFO

Lumen	CCT
1500 lm	3000 K
1750 lm	4000 K

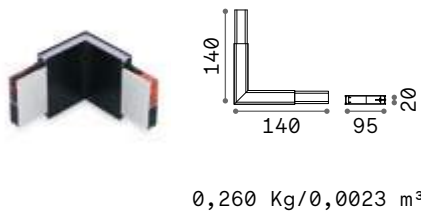

CORNER Optional - Up-light non inclusa

Potenza	Angolo	Lumen	CCT	Finitura	Codice	€
5,5W	104°	640 lm	3000 K	Bianco	241999	46
				Nero	242002	46
		730 lm	4000 K	Bianco	268149	46
				Nero	268118	46



STRUCTURE CONNECTOR

Necessario	Codice	€
SI - 1Kit x giunzione	241982	6



Light beam: **BI-EMISSION**
WIDE

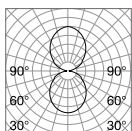

m	lx	Øm
1	572	2,56
2	143	5,12
3	64	7,68
4	36	10,24
5	23	12,80



CRI≥90 32W 104°+104° 1750+1750lm 4000K



P. 375



241968

241975

Fluo

Sistema lineare di lampade con scocca in alluminio estruso di sezione larga 50 mm e alta 80 mm. Moduli disponibili in due lunghezze: 1200 mm e 1800 mm, componibili tra loro a seconda della disposizione desiderata. Il sistema è disponibile con due diverse configurazioni: il modello WIDE diffondente e il modello BI-EMISSION con componente luminosa per l'illuminazione indiretta; LED integrati con temperatura di colore 3000 K o 4000 K; indice di resa cromatica CRI ≥ 90 , binning iniziale ≤ 3 Step MacAdam; protezione IP 20, classe isolamento I; durata utile LED 50.000 h L70B50. Il sistema è disponibile nei colori bianco e nero e nelle possibili modalità d'installazione singola o in linea continua, per applicazione a plafone, a sospensione oppure a incasso a filo in soffitti di cartongesso. Driver incluso, integrato nel corpo illuminante, disponibile in versione dimmerabile 1-10V, DALI e Push. Sistema adatto per ambienti dove è richiesta un'illuminazione professionale dal design minimale, ad esempio spazi COMMERCIALI e RETAIL.

PRO

Prodotto ad alto contenuto tecnologico, elevata qualità dei materiali, destinato ad uso professionale.

Sorgente	LED SMD
Driver incluso	On/Off
Driver disponibili	1-10V / DALI/Push
MacAdam	SDCM 3
Ottica	Accent/Wide/Bi-Emission
CCT	3000 K / 4000 K
CRI	≥ 90
Durata LED	50.000 h
Classe isolamento	I
IP	20
Materiale	Alluminio
Garanzia	5 anni





Fluo Wide

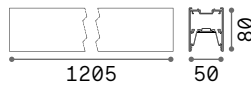

2,890 Kg/0,0183 m³
Lunghezza cavo 2150 mm

LED SMD SAMSUNG Driver TRIDONIC ON/OFF incluso

Potenza	Angolo	Lumen	CCT	Finitura	Codice	€
27 W	105°	3350 lm	3000 K	Bianco	192437	330
				Nero	191997	330
		3600 lm	4000 K	Bianco	192482	330
				Nero	192505	330

DIMMABLE DRIVER* Optional

	Potenza	Output	Misura (L x H x P)	Codice	€
1-10V	28 W	500 mA	280 x 21 x 30 mm	216423	145
DALI/Push	27 W	500 mA	280 x 21 x 30 mm	216287	160



4,420 Kg/0,0257 m³
Lunghezza cavo 2150 mm

LED SMD SAMSUNG Driver TRIDONIC ON/OFF incluso

Potenza	Angolo	Lumen	CCT	Finitura	Codice	€
36 W	105°	4600 lm	3000 K	Bianco	192550	425
				Nero	192567	425
		4750 lm	4000 K	Bianco	192604	425
				Nero	192628	425

DIMMABLE DRIVER* Optional

	Potenza	Output	Misura (L x H x P)	Codice	€
1-10V	39 W	700 mA	280 x 21 x 30 mm	216416	145
DALI/Push	38 W	700 mA	280 x 21 x 30 mm	216270	160

MOUNTING KIT Necessario - Pagina 641



Light beam: **WIDE**

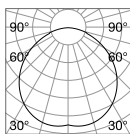

m	lx	Øm
1	1042	2,50
2	260	5,00
3	115	7,50
4	65	10,00
5	41	12,50

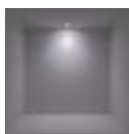

CRI≥90 27W 105° 3600lm 4000K

* Gli alimentatori dimmerabili devono essere ordinati contestualmente al prodotto e verranno già inclusi all'interno degli apparecchi in sostituzione degli alimentatori on-off. La connessione in linea è disponibile soltanto per le versioni on-off dei prodotti.



Fluo Wide 1200



Fluo Wide 1800

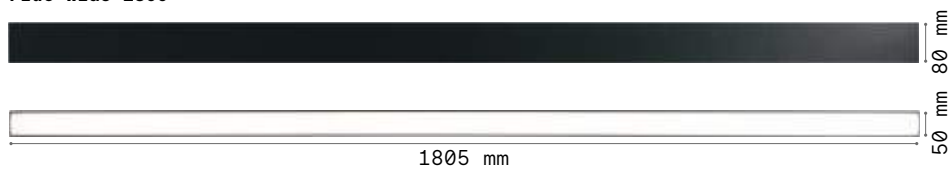

Lo spessore del singolo cappuccio finale è di 2,5 mm.

Fluo Bi-Emission*



LED SMD SAMSUNG

Up-light inclusa - Driver TRIDONIC ON/OFF incluso

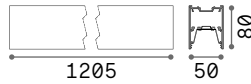

2,890 Kg/0,0183 m³
Lunghezza cavo 2150 mm

Potenza	Angolo	Lumen	CCT	Finitura	Codice	€
27 W	105°	3300 lm	3000 K	Bianco	192666	425
				Nero	192710	425
		3550 lm	4000 K	Bianco	192741	425
				Nero	192758	425

UP-LIGHT INFO

Potenza	Angolo	Lumen	CCT
13 W	105°	1800 lm	3000 K
		1900 lm	4000 K

KIT DIMMABLE DRIVER*

	Codice	€
1-10V	270692	230
DALI/Push	270876	260

LED SMD SAMSUNG

Up-light inclusa - Driver TRIDONIC ON/OFF incluso



4,420 Kg/0,0269 m³
Lunghezza cavo 2150 mm

Potenza	Angolo	Lumen	CCT	Finitura	Codice	€
36 W	105°	4800 lm	3000 K	Bianco	192703	580
				Nero	192697	580
		4950 lm	4000 K	Bianco	192673	580
				Nero	192642	580

UP-LIGHT INFO

Potenza	Angolo	Lumen	CCT
18 W	105°	2400 lm	3000 K
		2550 lm	4000 K

KIT DIMMABLE DRIVER*

	Codice	€
1-10V	270883	230
DALI/Push	270937	260



Light beam: **BI-EMISSION**
WIDE

MOUNTING KIT Necessario - Pagina 641

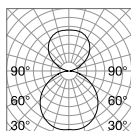

m	lx	Øm
1	512	2,10
2	128	4,21
3	56	6,32
4	32	8,43
5	20	10,54



* Accensione separata dell'emissione diretta e indiretta (disponibile solo per versioni on-off). Regolazione in sincronia dell'emissione diretta e indiretta (versioni con dimmerazione 1-10V e Push). Gli alimentatori dimmerabili devono essere ordinati contestualmente al prodotto e verranno già inclusi all'interno degli apparecchi in sostituzione degli alimentatori on-off. La connessione in linea è disponibile soltanto per le versioni on-off dei prodotti.

CRI≥90 27+13W 105°+105° 3300+1800lm 3000K



Fluo Bi-Emission 1200

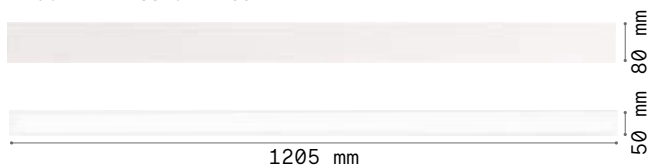

Fluo Bi-Emission 1800

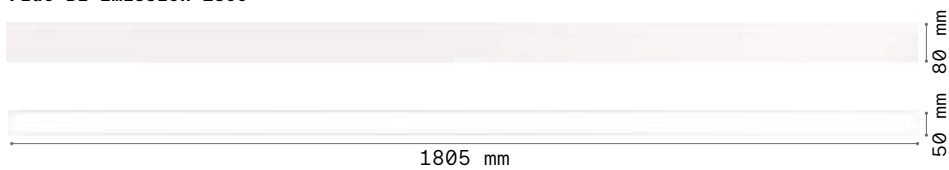

Lo spessore del singolo cappuccio finale è di 2,5 mm.

Fluo - Assembly plans

FLUO SUSPENSION

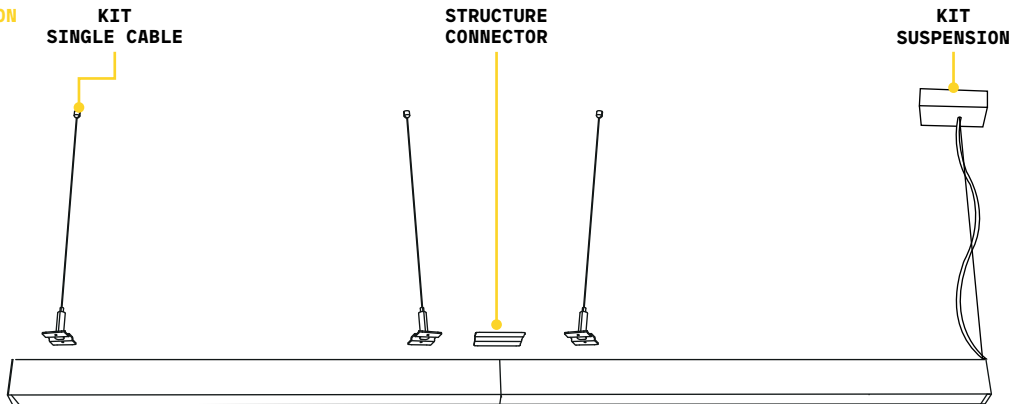

FLUO SURFACE

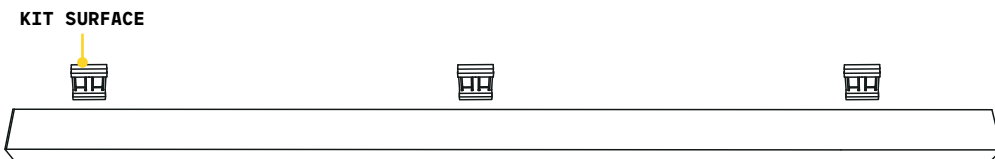



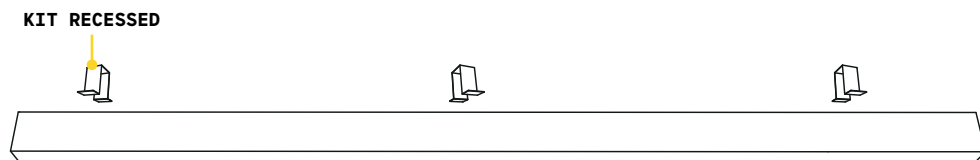

FLUO RECESSED





Fluo - Mounting kit

	Necessario	N° Cavi	Lunghezza cavi	Finitura	Codice	€
 KIT SUSPENSION	SI - 1 kit x punto di alimentazione	1	2000 mm	Bianco	277929	32
				Nero	277912	32
		1	5000 mm	Bianco	276342	43
				Nero	276335	43
 KIT SINGLE CABLE	SI - 1Kit x 600 mm	1	2000 mm		220826	13
		1	5000 mm		243665	20
 KIT RECESSED	SI - 1Kit x 600 mm				191188	25
 KIT SURFACE	SI - 1Kit x 600 mm				191171	25

STRUCTURE CONNECTOR Lunghezza max per punto di alimentazione: 30 metri



Necessario	Codice	€
SI - 1Kit x giunzione	191508	12

Steel new

Lampada lineare in alluminio con illuminazione diretta e indiretta con controllo dell'abbagliamento. La componente di luce indiretta può essere accesa o spenta mediante interruttore a bordo dell'apparecchio. La lampada è disponibile nel modello WIDE con ottica downlight diffondente in PMMA microprismatizzato (UGR < 19) e nel modello ACCENT con riflettore nero (UGR < 16). Sorgenti LED integrati; disponibile in CCT 3000 K e 4000 K; CRI ≥ 90; lifetime 50.000 h L70B50; IP20. Adatta per uffici, spazi commerciali e retail.

PRO Prodotto ad alto contenuto tecnologico, elevata qualità dei materiali, destinato ad uso professionale.

UGR Articolo con UGR <16 (Accent), <19 (Wide).

Sorgente	LED SMD
Driver incluso	On/Off
Driver disponibili	No
MacAdam	SDCM 3
Ottica	Accent/Wide
CCT	3000 K / 4000 K
CRI	≥90
UGR	<16 (Accent) / <19 (Wide)
Durata LED	50.000 h
Classe isolamento	I - II
IP	20
Materiale	Alluminio
Garanzia	5 anni





Steel

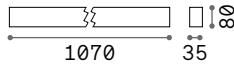
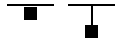

1,990 Kg/0,0178 m³
Lunghezza cavo 1800 mm

LED SMD SAMSUNG

Up-light inclusa - Driver OSRAM ON/OFF incluso - UGR <19

Potenza	Angolo	Lumen	CCT	Finitura	Codice	€
36 W	70°	3350 lm	3000 K	Bianco	267128	290
				Nero	270197	290
		3550 lm	4000 K	Bianco	270203	290
				Nero	267135	290

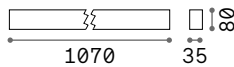

1,980 Kg/0,0178 m³
Lunghezza cavo 1800 mm





LED SMD SAMSUNG

Up-light inclusa - Driver OSRAM ON/OFF incluso - UGR <16

Potenza	Angolo	Lumen	CCT	Finitura	Codice	€
36 W	60°	3000 lm	3000 K	Bianco	270180	345
				Nero	267142	345
		3200 lm	4000 K	Bianco	267159	345
				Nero	270173	345

UP-LIGHT INFO

Angolo	Lumen	CCT
110°	1100 lm	3000 K
	1150 lm	4000 K

	Necessario	N° Cavi	Lunghezza cavi	Finitura	Codice	€
	SI - 1 kit x punto di alimentazione	1	2000 mm	Bianco	276311	35
				Nero	276304	35
	SI - 1 Kit x 500 mm	1	2000 mm		271750	13
	SI - 1 Kit x 1000 mm				270210	31
	SI - 1 Kit x giunzione				271712	7



Light beam: BI-EMISSION
WIDE

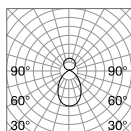

m	lx	cm
1	1173	1,50
2	293	3,10
3	130	4,60
4	73	6,20
5	47	7,70



Light beam: BI-EMISSION
ACCENT

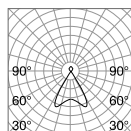

m	lx	cm
1	2216	1,20
2	554	2,40
3	246	3,60
4	139	4,80
5	89	6,10



CRI≥90 36W 70°+110° 3550+1150lm 4000K

CRI≥90 36W 60°+110° 3200+1150lm 4000K



Steel Accent



1070

Steel Wide



1070

Steel Slim

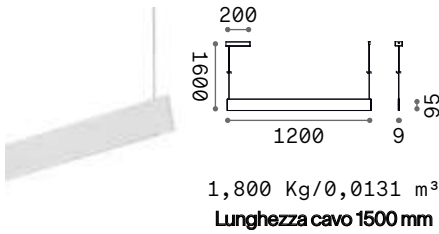

LED SMD SAMSUNG

Up-light inclusa - Driver OSRAM ON/OFF incluso - UGR <19

Potenza	Angolo	Lumen	CCT	Finitura	Codice	€
35W	110°	2900 lm	3000 K	Bianco	348407	175 <i>new</i>
				Nero	348384	175 <i>new</i>

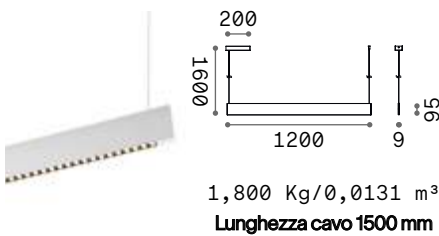

LED SMD SAMSUNG

Up-light inclusa - Driver OSRAM ON/OFF incluso - UGR <16

Potenza	Angolo	Lumen	CCT	Finitura	Codice	€
35W	70°	2900 lm	3000 K	Bianco	348414	175 <i>new</i>
				Nero	348391	175 <i>new</i>

UP-LIGHT INFO

Angolo	Lumen	CCT
110°	1100 lm	3000 K



Light beam: **BI-EMISSION WIDE**

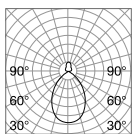

m	lx	cm
1	937	1,50
2	234	3,10
3	104	4,60
4	59	6,20
5	37	7,70



Light beam: **BI-EMISSION ACCENT**

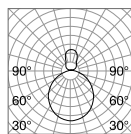

m	lx	cm
1	616	2,80
2	154	5,60
3	68	8,50
4	39	11,00
5	25	14,00



CRI≥90 35W 110°+110° 2900+1100lm 3000K

CRI≥90 35W 70°+110° 2900+1100lm 3000K



Steel Slim Accent

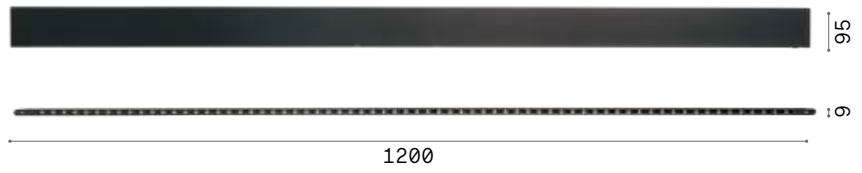

Steel Slim Wide

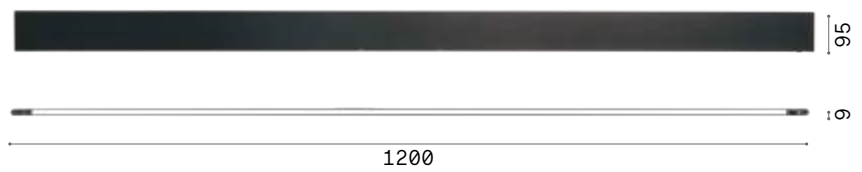

Office



Lampada lineare in alluminio con illuminazione diretta per applicazione a sospensione. Disponibile in finitura bianca o nera con riflettori di colore nero. Sorgenti LED integrate con controllo dell'abbagliamento (UGR < 16); disponibile in temperatura di colore 3000 K e 4000 K; CRI ≥ 90; 50.000 h di durata L70B50; protezione IP20, classe isolamento I.

Sorgente	LED SMD	Durata LED	50.000 h
Potenza	30W	Classe	I
Driver incluso	On/Off	isolamento	
Driver disponibili	No	IP	20
CCT	3000 K / 4000 K	Materiale	Alluminio
CRI	≥90	Garanzia	5 anni
UGR	<16		

UGR Articolo con UGR <16.

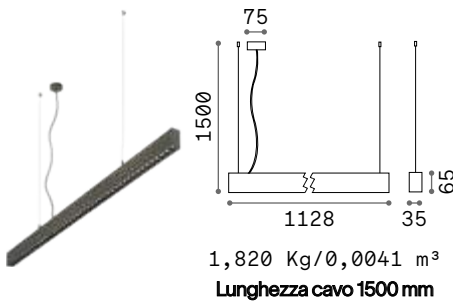

LED SMD Driver ON/OFF incluso

Potenza	Angolo	Lumen	CCT	Finitura	Codice	€
30 W	37°	3350 lm	3000 K	Bianco	271194	220
				Nero	271187	220
30 W	37°	3700 lm	4000 K	Bianco	271217	220
				Nero	271200	220



Light beam: ACCENT

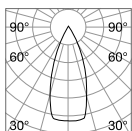

m	lx	Øm
1	6008	0,72
2	1502	1,40
3	668	2,20
4	376	2,90
5	240	3,60



CRI≥90 30W 37° 3700lm 4000K



271194

271187



LED Strip e supporti

Interni

Indice alfabetico

Slot	652
Strip Led	644
Tesi	648

Indice icone

new



Strip 644

new



Tesi 648

new



Slot Recessed 654



Slot Surface 656

new



Slot Angular 658

* Per le strip led al prezzo indicato non sono applicabili ulteriori promozioni.

Strip LED and Drivers new

Volt	24 Vdc
Sorgente	LED COB / SMD
Driver disponibili	On/Off / 1-10V / DALI/Push
Potenza	5 / 8 / 10 / 15 / 20 / 40 W/m
MacAdam	SDCM 3
CCT	2700 K / 3000 K / 4000 K
CRI	≥90
Angolo	120°
Durata LED	50.000 h
Garanzia	5 anni

SMD 2835 180 LED/m - 50.000h

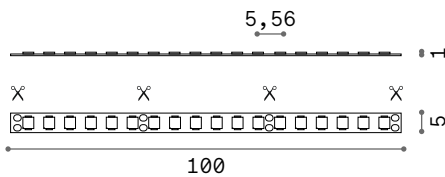

Potenza	IP	Lumen	CCT	Dimensioni	Codice	€
8 W/m	IP20	670 lm/m	2700 K	5x5000mm	345772	50 new
		700 lm/m	3000 K	5x5000mm	345789	50 new
		750 lm/m	4000 K	5x5000mm	345796	50 new
15 W/m	IP20	1290 lm/m	2700 K	5x5000mm	345765	65 new
		1340 lm/m	3000 K	5x5000mm	332239	65 new
		1380 lm/m	4000 K	5x5000mm	332246	65 new

SMD 2835 120 LED/m - 50.000h

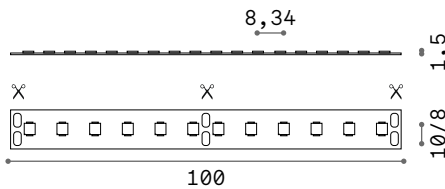

Potenza	IP	Lumen	CCT	Dimensioni	Codice	€
5 W/m	IP20	470 lm/m	2700 K	8x5000mm	346328	50 new
		490 lm/m	3000 K	8x5000mm	346335	50 new
		510 lm/m	4000 K	8x5000mm	346359	50 new
	IP65	460 lm/m	3000 K	8x5000mm	346342	60 new
		500 lm/m	4000 K	8x5000mm	346366	60 new
		10 W/m	IP20	910 lm/m	2700 K	8x5000mm
940 lm/m	3000 K	8x5000mm		346380	50 new	
970 lm/m	4000 K	8x5000mm		346403	50 new	
	IP65	960 lm/m	3000 K	8x5000mm	346397	60 new
		1040 lm/m	4000 K	8x5000mm	346410	60 new
		15 W/m	IP20	1400 lm/m	2700 K	10x5000mm
1450 lm/m	3000 K	10x5000mm		272481	55	
1600 lm/m	4000 K	10x5000mm		272474	55	
	IP65	1400 lm/m	3000 K	10x5000mm	272504	75
		1480 lm/m	4000 K	10x5000mm	287959	75

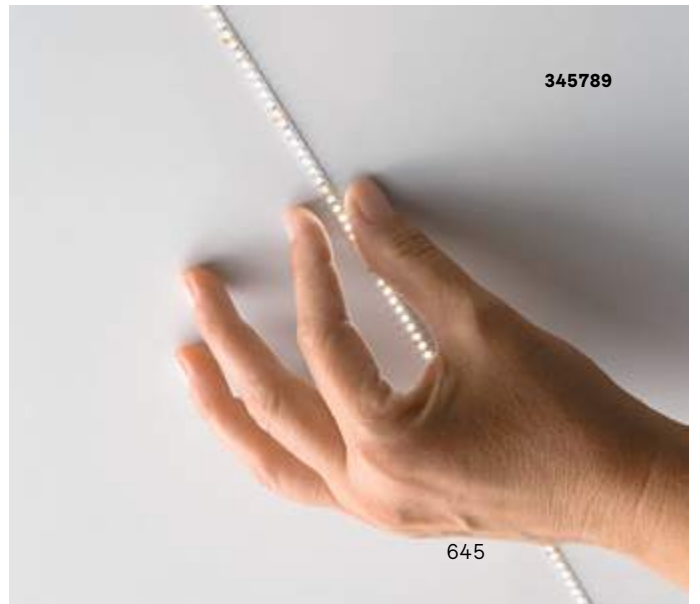

Strip LED and Drivers

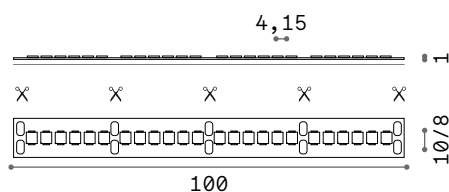

SMD 2835 240 LED/m - 50.000 h

Potenza	IP	Lumen	CCT	Dimensioni	Codice	€
10 W/m	IP20	990 lm/m	2700 K	8x5000mm	346427	65 <i>new</i>
		1000 lm/m	3000 K	8x5000mm	346434	65 <i>new</i>
		1060 lm/m	4000 K	8x5000mm	346458	65 <i>new</i>
15 W/m	IP65	880 lm/m	3000 K	8x5000mm	346441	80 <i>new</i>
		900 lm/m	4000 K	8x5000mm	346465	80 <i>new</i>
		1330 lm/m	2700 K	8x5000mm	346472	65 <i>new</i>
20.5 W/m	IP20	1450 lm/m	3000 K	8x5000mm	346489	65 <i>new</i>
		1510 lm/m	4000 K	8x5000mm	346502	65 <i>new</i>
		1460 lm/m	4000 K	8x5000mm	346519	80 <i>new</i>
20.5 W/m	IP65	2000 lm/m	2700 K	10x5000mm	272535	90
		2050 lm/m	3000 K	10x5000mm	272528	90
		2100 lm/m	4000 K	10x5000mm	272511	90
	IP65	2000 lm/m	3000 K	10x5000mm	272542	105
		2020 lm/m	4000 K	10x5000mm	287966	105

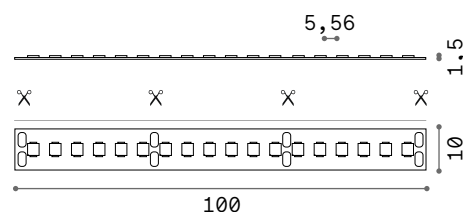

SMD 2835 180 LED/m - 50.000h

Potenza	IP	Lumen	CCT	Dimensioni	Codice	€
40 W/m	IP20	4350 lm/m	3000 K	10x3000mm	253886	145
		4410 lm/m	4000 K	10x3000mm	253893	145

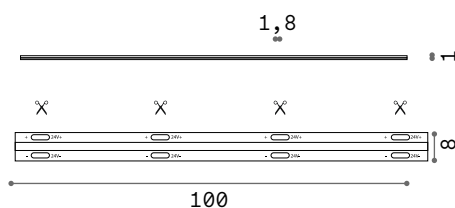

COB 180 LED/m - 50.000h

Potenza	IP	Lumen	CCT	Dimensioni	Codice	€
8 W/m	IP20	760 lm/m	2700 K	8x5000mm	325934	60 <i>new</i>
		790 lm/m	3000 K	8x5000mm	325958	60 <i>new</i>
		820 lm/m	4000 K	8x5000mm	325972	60 <i>new</i>
15 W/m	IP20	1350 lm/m	2700 K	8x5000mm	325941	60 <i>new</i>
		1470 lm/m	3000 K	8x5000mm	325965	60 <i>new</i>
		1620 lm/m	4000 K	8x5000mm	325989	60 <i>new</i>



MAIN CONNECTOR

Necessario

Codice

€

No

292939

2



LINEAR CONNECTOR

No

292953

2

DRIVER Solo per installazione in interni



	Potenza	Output	Classe	Misura (LxHxP)	Codice	€
On-Off	30 W	24 Vdc	□	140 x 28 x 45 mm	124070	17
	60 W	24 Vdc	□	186 x 33 x 50 mm	124087	25
	150 W	24 Vdc	⊕	268 x 31 x 45 mm	124117	45
1-10V/Push	36 W	24 Vdc	□	293 x 30 x 43 mm	244556	40
1-10V	100 W	24 Vdc	⊕	210 x 34 x 67 mm	244570	65
1-10V/Push	150 W	24 Vdc	⊕	352 x 30 x 43 mm	244594	65
DALI/Push	36 W	24 Vdc	□	175 x 30 x 44 mm	244549	55
	80 W	24 Vdc	⊕	295 x 35 x 45 mm	244563	65
	150 W	24 Vdc	⊕	273 x 37 x 57 mm	244587	90

Tesi 8mm new



Nastro flessibile in acciaio per applicazione in tensione da parete a parete, da utilizzare come supporto per l'applicazione di strip LED per illuminazione indiretta. Nastro disponibile in due larghezze di 8 mm e 20 mm, lunghezza massima di 5 o 10 metri sezionabile su misura, supporti in alluminio con sistema di bloccaggio, disponibile nelle finiture acciaio, bianco oppure nero. Ideale per ambienti dal carattere storico e architettonico già fortemente personalizzati, con la sua sezione minimale scompare all'interno dell'ambiente per garantire un risultato di estrema pulizia formale.

STRIP LED SUPPORT

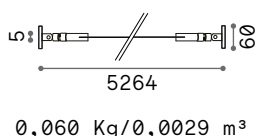

Lunghezza	Larghezza	Finitura	Codice	€
5000 mm	8 mm	Acciaio	344935	150 new
		Bianco	344928	150 new
		Nero	344911	150 new

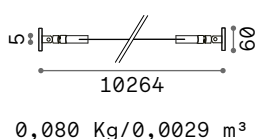

Lunghezza	Larghezza	Finitura	Codice	€
10000 mm	8 mm	Acciaio	344904	165 new
		Bianco	344898	165 new
		Nero	344881	165 new

RECOMMENDED STRIP LED AND DRIVER

SMD 2835 180 LED/m - 50.000h

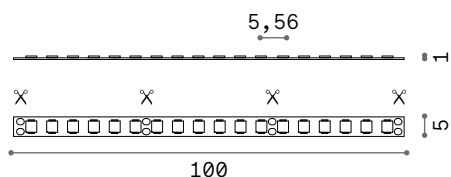

Potenza	IP	Lumen	CCT	Dimensioni	Codice	€
8 W/m	IP20	670 lm/m	2700 K	5x5000mm	345772	50 new
		700 lm/m	3000 K	5x5000mm	345789	50 new
		750 lm/m	4000 K	5x5000mm	345796	50 new

DRIVER ON/OFF

Potenza	Output	Classe	Misura (L x H x P)	Driver box	Codice	€
30 W	24 Vdc	□	140 x 28 x 45 mm	255 x 55 x 75 mm	124070	17
60 W	24 Vdc	□	186 x 33 x 50 mm	255 x 55 x 75 mm	124087	25
150 W	24 Vdc	⊕	268 x 31 x 45 mm	330 x 60 x 80 mm	124117	45



Light beam: **INDIRECT**





Tesi 20mm new



STRIP LED SUPPORT

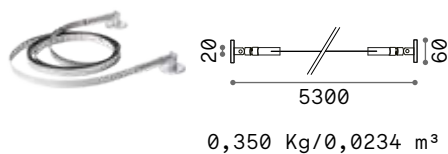

Lunghezza	Larghezza	Finitura	Codice	€
5000 mm	20 mm	Acciaio	258300	150
		Bianco	302256	150
		Nero	302263	150

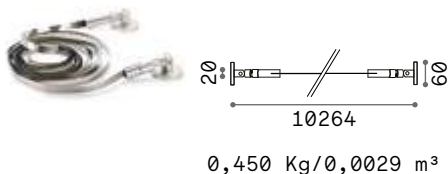

Lunghezza	Larghezza	Finitura	Codice	€
10000 mm	20 mm	Acciaio	302270	175
		Bianco	302287	175
		Nero	302294	175

RECOMMENDED STRIP LED AND DRIVER

SMD 2835 120 LED/m - 50.000h

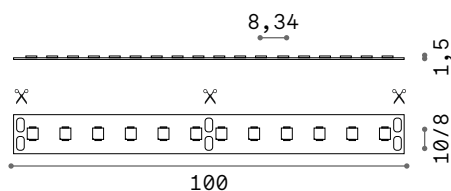

Potenza	IP	Lumen	CCT	Dimensioni	Codice	€
5 W/m	IP20	470 lm/m	2700 K	8x5000mm	346328	50 new
		490 lm/m	3000 K	8x5000mm	346335	50 new
		510 lm/m	4000 K	8x5000mm	346359	50 new
5 W/m	IP65	460 lm/m	3000 K	8x5000mm	346342	60 new
		500 lm/m	4000 K	8x5000mm	346366	60 new
		910 lm/m	2700 K	8x5000mm	346373	50 new
10 W/m	IP20	940 lm/m	3000 K	8x5000mm	346380	50 new
		970 lm/m	4000 K	8x5000mm	346403	50 new
		960 lm/m	3000 K	8x5000mm	346397	60 new
10 W/m	IP65	1040 lm/m	4000 K	8x5000mm	346410	60 new
		1400 lm/m	2700 K	10x5000mm	272498	55
		1450 lm/m	3000 K	10x5000mm	272481	55
15 W/m	IP20	1600 lm/m	4000 K	10x5000mm	272474	55
		1400 lm/m	3000 K	10x5000mm	272504	75
		1480 lm/m	4000 K	10x5000mm	287959	75

DRIVER ON/OFF



Light beam: **INDIRECT**



Potenza	Output	Classe	Misura (L x H x P)	Driver box	Codice	€
30 W	24 Vdc	□	140 x 28 x 45 mm	255 x 55 x 75 mm	124070	17
60 W	24 Vdc	□	186 x 33 x 50 mm	255 x 55 x 75 mm	124087	25
150 W	24 Vdc	⊕	268 x 31 x 45 mm	330 x 60 x 80 mm	124117	45

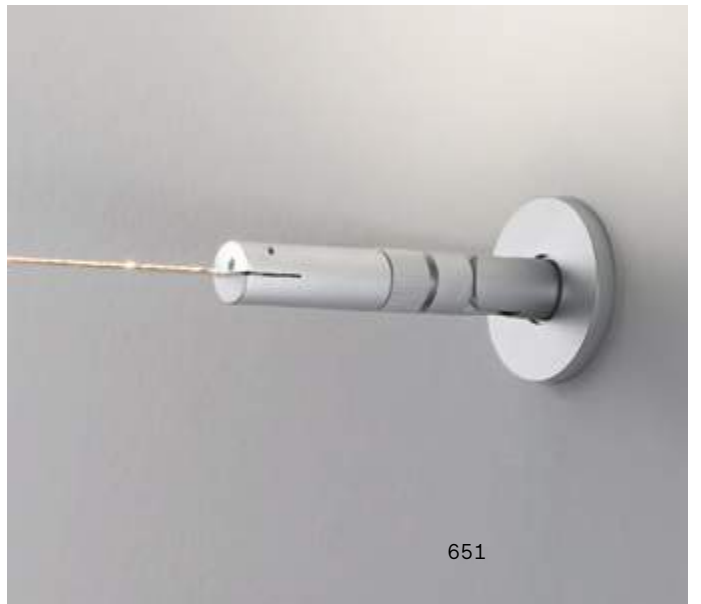

Slot

Profilo in alluminio estruso con superficie anodizzata o verniciata a polveri, disponibile nelle finiture bianco, nero e alluminio, diffusore in PMMA satinato. Sono disponibili barre in diverse sezioni e lunghezze nella versione RECESSED per installazione a incasso in soffitti in cartongesso e nella versione SURFACE per installazione a parete o soffitto. I modelli ANGULAR in versione tonda e quadrata sono concepiti con un angolo interno di inclinazione della sorgente luminosa per l'illuminazione ottimale all'interno di velette e gole luminose. I profili lineari sono disponibili nelle lunghezze di 2000 e 3000 mm, sono componibili a seconda del disegno desiderato e sono sezionabili a misura. Strip LED e driver devono essere abbinati per completare l'installazione.

Versione	Recessed / Surface / Angular
Larghezza	6 / 31 mm
Materiale	Alluminio





Slot Recessed

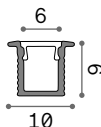

6 x 9 mm Kit per montaggio incluso - Non compatibile con strip LED IP65

Lunghezza	Peso	Volume	Finitura	Codice	€
2000 mm	0,14 Kg	0,0082 m ³	Bianco	346212	8 <small>new</small>
3000 mm	0,21 Kg	0,0122 m ³	Bianco	346229	12 <small>new</small>

STRIP LED AND DRIVER Strip LED consigliata max 8 W/m

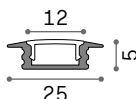

12 x 5 mm Kit per montaggio incluso - Non compatibile con strip LED IP65

Lunghezza	Peso	Volume	Finitura	Codice	€
2000 mm	0,35 Kg	0,0020 m ³	Bianco	203102	25
3000 mm	0,54 Kg	0,0029 m ³	Bianco	204611	40

STRIP LED AND DRIVER Strip LED consigliata max 15 W/m

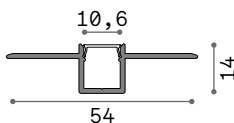

10,6 x 14 mm Non compatibile con strip LED IP65

Lunghezza	Peso	Volume	Finitura	Codice	€
2000 mm	0,60 Kg	0,0031 m ³	Bianco	346274	45 <small>new</small>
3000 mm	0,89 Kg	0,0068 m ³	Bianco	346281	65 <small>new</small>

STRIP LED AND DRIVER Strip LED consigliata max 8 W/m

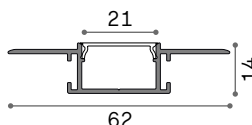

21 x 14 mm

Lunghezza	Peso	Volume	Finitura	Codice	€
2000 mm	0,71 Kg	0,0049 m ³	Bianco	346762	55 <small>new</small>
3000 mm	1,06 Kg	0,0039 m ³	Bianco	346779	75 <small>new</small>

STRIP LED AND DRIVER Strip LED consigliata max 15 W/m

KIT PROFILE 21 x 14 mm



KIT LINEAR

KIT RIGHT-LEFT

KIT VERTICAL-HORIZONTAL

Necessario	Codice	€
SI - 1 Kit x giunzione	223766	6
SI - 1 Kit x giunzione	223759	6
SI - 1 Kit x giunzione	223742	6

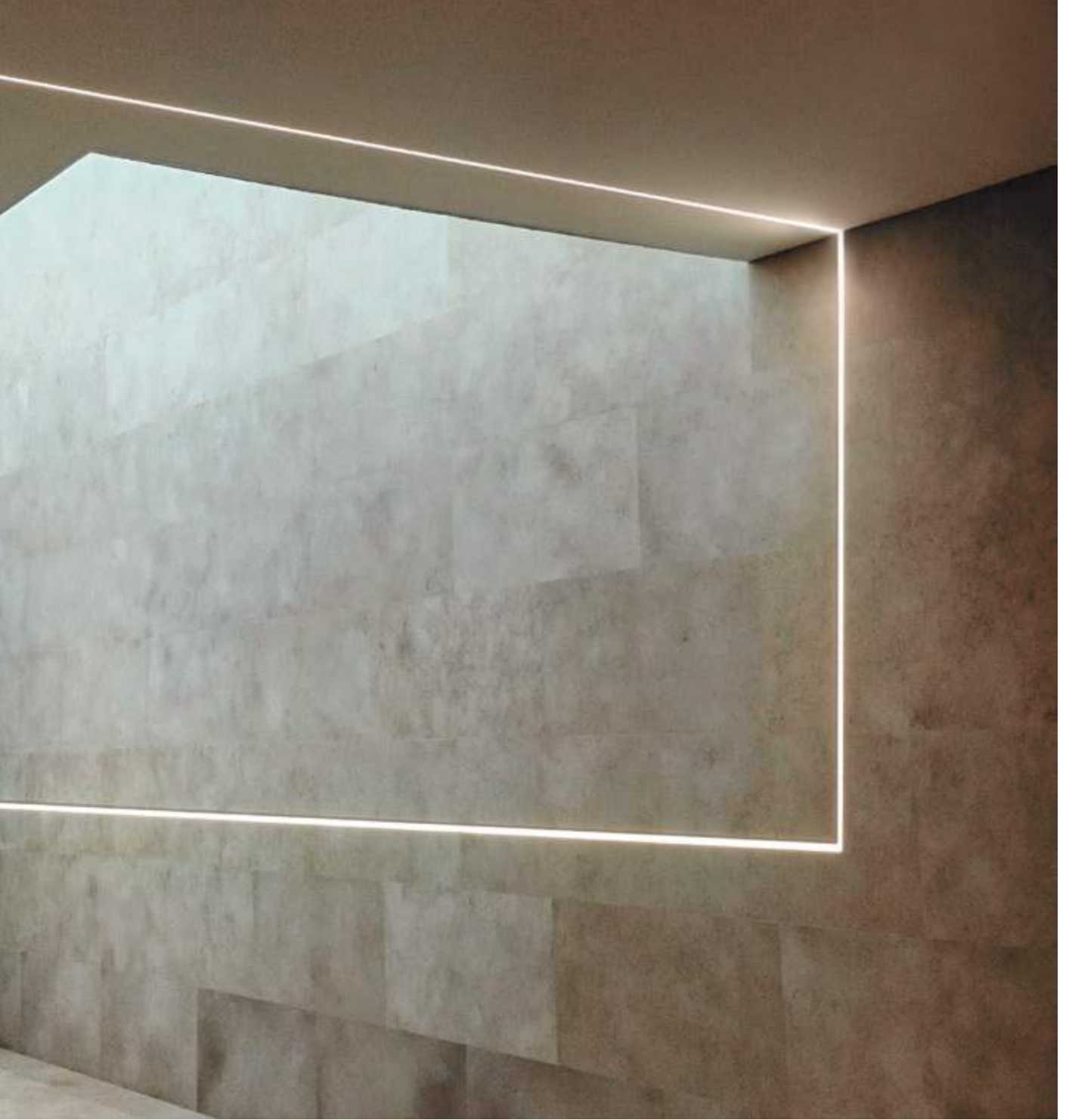

Kit per montaggio PROFILE 12 mm.



346762
346779

655

Slot Surface

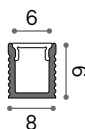
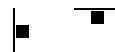

6 x 9 mm Kit per montaggio incluso - Non compatibile con strip LED IP65

Lunghezza	Peso	Volume	Finitura	Codice	€
2000 mm	0,14 Kg	0,0082 m ³	Bianco	346243	8 new
	0,14 Kg	0,0082 m ³	Nero	346236	8 new
3000 mm	0,21 Kg	0,0122 m ³	Bianco	346267	12 new
	0,21 Kg	0,0122 m ³	Nero	346250	12 new

STRIP LED AND DRIVER Strip LED consigliata max 8 W/m

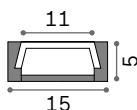

11 x 5 mm Kit per montaggio incluso - Non compatibile con strip LED IP65

Lunghezza	Peso	Volume	Finitura	Codice	€
2000 mm	0,20 Kg	0,0020 m ³	Bianco	203089	20
	0,20 Kg	0,0020 m ³	Alluminio	203072	20
3000 mm	0,34 Kg	0,0029 m ³	Bianco	204598	30
	0,34 Kg	0,0029 m ³	Alluminio	204581	30

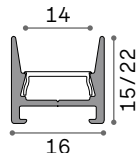

14 x 15 / 22 mm Kit per montaggio incluso - Non compatibile con strip LED IP65

Dimensioni	Peso	Volume	Finitura	Codice	€
2000x15mm	0,20 Kg	0,0015 m ³	Bianco	307145	25
2000x22mm	0,40 Kg	0,0021 m ³	Bianco	307152	25

STRIP LED AND DRIVER Strip LED consigliata max 15 W/m

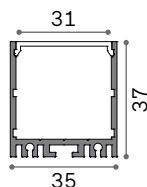

31 x 37 mm Kit per montaggio incluso

Lunghezza	Peso	Volume	Finitura	Codice	€
2000 mm	1,40 Kg	0,0032 m ³	Bianco	270524	75
	1,40 Kg	0,0032 m ³	Nero	270517	75
3000 mm	2,10 Kg	0,0048 m ³	Bianco	270548	105
	2,10 Kg	0,0048 m ³	Nero	270531	105



SUSPENSION KIT

STRUCTURE CONNECTOR

Necessario	N° Cavi	Lunghezza cavi	Codice	€
No - 1 Kit x 2000 mm	2	3000 mm	270449	18
SI - 1 Kit x giunzione			270463	6

STRIP LED AND DRIVER Strip LED consigliata max 40 W/m



Kit per montaggio 11 x 5 mm.



307145



270517

Slot Angular Surface

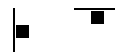

ROUND 10 x 10 mm



Lunghezza	Peso	Volume	Finitura	Codice	€
2000 mm	0,16 Kg	0,0027 m ³	Bianco	346298	20 <small>new</small>
3000 mm	0,24 Kg	0,0055 m ³	Bianco	346304	30 <small>new</small>

ROUND 16 x 16 mm



Lunghezza	Peso	Volume	Finitura	Codice	€
2000 mm	0,30 Kg	0,0020 m ³	Bianco	203126	25
3000 mm	0,44 Kg	0,0029 m ³	Bianco	204635	40

STRIP LED AND DRIVER Strip LED consigliata max 15 W/m

Slot Angular Recessed

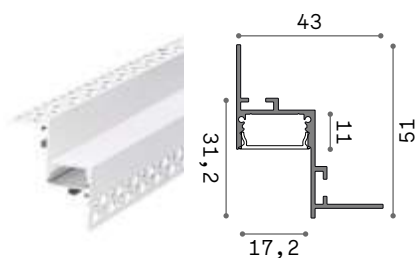
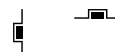

17,2 x 11 mm

Lunghezza	Peso	Volume	Finitura	Codice	€
2000 mm	0,92 Kg	0,0031 m ³	Bianco	339788	65 <small>new</small>
3000 mm	1,38 Kg	0,0082 m ³	Bianco	339795	90 <small>new</small>

STRIP LED AND DRIVER Strip LED consigliata max 15 W/m

KIT PROFILE 21 x 14 mm / 17,2 x 11 mm



KIT LINEAR

KIT RIGHT-LEFT

KIT VERTICAL-HORIZONTAL

Necessario	Codice	€
SI - 1Kit x giunzione	223766	6
SI - 1Kit x giunzione	223759	6
SI - 1Kit x giunzione	223742	6



Kit per montaggio
PROFILE ROUND 10x10 mm.



339788
339795



















Proiettori e binari

Interni

Indice alfabetico

Byte	696
Display	700
Eos	686
Fox	678
Glim	695
Link	708
Link Mono	714
Look	698
Mouse	694
Pov	692
Quick	662
Smile	670
Spike	697
Spot	694

Indice icone

 <small>new</small>		 <small>new</small>
Quick 662	Smile 670	Fox 678
 <small>new</small>		 <small>new</small>
Eos 686	Pov 692	Mouse 694
 <small>new</small>		 <small>new</small>
Spot 694	Glim 695	Byte 696
 <small>new</small>		
Spike 697	Look 698	
 <small>new</small>	 <small>new</small>	 <small>new</small>
Display Accent 702	Display Wide 704	Display UGR 706
	 <small>new</small>	
Link 3-Phase 708	Link 1-Phase 714	

Quick

Proiettore cilindrico in alluminio estruso adatto per installazione su binario trifase. Verniciatura a polveri bianco o nero, testata girevole 355° e orientabile 90°. Il driver di alimentazione incluso, trova alloggiamento nel corpo cilindrico del proiettore stesso. Sorgente luminosa con tecnologia COB LED integrato per la massima efficienza, disponibile con temperatura di colore di 3000 K o 4000 K; LED efficienza energetica elevata resa cromatica fino a CRI ≥90; binning iniziale ≤3-Step MacAdam; ottica a fascio simmetrico con tre diversi angoli di emissione e controllo dell'abbagliamento (UGR <19). Montaggio e smontaggio senza utensili. Protezione IP20; classe isolamento I; durata utile LED 50.000 h L80B50. Ideale per l'illuminazione di grandi ambienti dove viene richiesta ampia flessibilità e resa cromatica, ad esempio spazi MUSEALI, COMMERCIALI e RETAIL.

PRO

Prodotto ad alto contenuto tecnologico, elevata qualità dei materiali, destinato ad uso professionale.

Sorgente	LED COB
Potenza	15W / 21W / 28W
Driver incluso	On/Off
Driver disponibili	No
Binario	3-Phase
MacAdam	SDCM 3
CCT	3000 K / 4000 K
CRI	≥80 / ≥90
Durata LED	50.000h
Classe isolamento	I
IP	20
Materiale	Alluminio
Garanzia	5 anni



Link 3-Phase - Pagina 708





Quick 15W

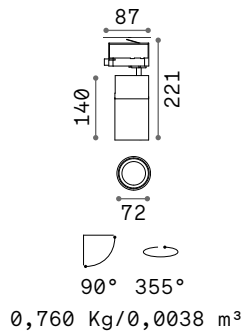

3-PHASE LED COB CITIZEN

CRI ≥ 80

Potenza	Angolo	Lumen	CCT	Finitura	Codice	€
15 W	30°	1800 lm	3000 K	Bianco	222509	145
				Nero	222523	145
		1950 lm	4000 K	Bianco	222530	145
				Nero	222547	145

CRI ≥ 90

Potenza	Angolo	Lumen	CCT	Finitura	Codice	€
15 W	30°	1500 lm	3000 K	Bianco	222554	145
				Nero	222561	145
		1600 lm	4000 K	Bianco	222578	145
				Nero	222585	145



FILTER HONEYCOMB



LENS*



SINGLE CONNECTION

Necessario	Angolo	Finitura	Codice	€
No		Nero	222608	9
No	15°	Trasparen.	222592	9
No	45°	Trasparen.	253558	9
No		Bianco	170145	23
No		Nero	170152	23



Light beam: ACCENT

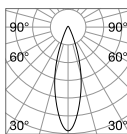

m	lx	Øm
1	3451	0,51
2	862	1,02
3	383	1,53
4	215	2,04
5	138	2,55



CRI ≥ 80 15W 30° 1800lm 3000K

* La lente deve essere ordinata contestualmente al prodotto e verrà montata nel prodotto al posto della lente standard inclusa.



Quick 21W

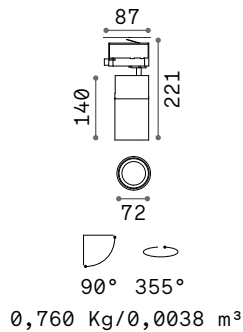

3-PHASE LED COB CITIZEN

CRI ≥ 80

Potenza	Angolo	Lumen	CCT	Finitura	Codice	€
21W	30°	2450 lm	3000 K	Bianco	247946	155
				Nero	247939	155
	2700 lm	4000 K	Bianco	247960	155	
			Nero	247953	155	

CRI ≥ 90

Potenza	Angolo	Lumen	CCT	Finitura	Codice	€
21W	30°	2000 lm	3000 K	Bianco	247977	155
				Nero	225364	155
	2150 lm	4000 K	Bianco	247991	155	
			Nero	247984	155	



FILTER HONEYCOMB



LENS*



SINGLE CONNECTION

Necessario	Angolo	Finitura	Codice	€
No		Nero	222608	9
No	15°	Trasparen.	222592	9
No	45°	Trasparen.	253558	9
No		Bianco	170145	23
		Nero	170152	23



Light beam: ACCENT

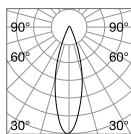

m	lx	Øm
1	6576	0,57
2	1644	1,14
3	731	1,71
4	411	2,28
5	263	2,85



CRI ≥ 80 21W 30° 2450lm 3000K

* La lente deve essere ordinata contestualmente al prodotto e verrà montata nel prodotto al posto della lente standard inclusa.



Quick 28W

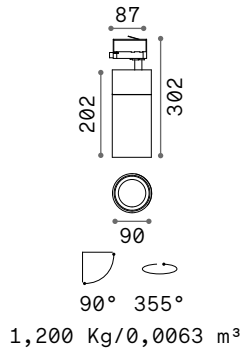

3-PHASE LED COB CITIZEN

CRI ≥ 80

Potenza	Angolo	Lumen	CCT	Finitura	Codice	€
28 W	30°	3550 lm	3000 K	Bianco	222615	185
				Nero	222622	185
		3800 lm	4000 K	Bianco	222639	185
				Nero	222646	185

CRI ≥ 90

Potenza	Angolo	Lumen	CCT	Finitura	Codice	€
28 W	30°	3100 lm	3000 K	Bianco	222653	185
				Nero	222660	185
		3300 lm	4000 K	Bianco	222677	185
				Nero	222684	185



FILTER HONEYCOMB



LENS*



SINGLE CONNECTION

Necessario	Angolo	Finitura	Codice	€
No		Nero	222714	10
No	18°	Trasparen.	222691	10
No	45°	Trasparen.	222707	10
No		Bianco	170145	23
		Nero	170152	23



Light beam: ACCENT

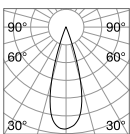

m	lx	Øm
1	8760	0,55
2	2190	1,11
3	973	1,67
4	547	2,22
5	350	2,78



CRI ≥ 80 28W 30° 3550lm 3000K

* La lente deve essere ordinata contestualmente al prodotto e verrà montata nel prodotto al posto della lente standard inclusa.



Smile

Proiettore cilindrico in alluminio (estrusione + lavorazione CNC + forgiatura) adatto per installazione su binario trifase. Verniciatura a polveri in bianco o nero, testata girevole 350° e orient. 90°; il driver di alimentazione è incluso e trova alloggiamento nel corpo cilindrico del proiettore stesso. Sorgente luminosa con tecnologia COB LED integrato, disponibile con una temperatura di colore di 3000 K o 4000 K e con indice di resa cromatica fino a 90; binning iniziale ≤ 4 -Step MacAdam; ottica a fascio simmetrico con tre diversi angoli di emissione e controllo dell'abbagliamento (UGR <19). Montaggio e smontaggio senza utensili. Protezione IP20; classe isolamento II; durata utile LED 50.000 h L70B50. Ideale per l'illuminazione di grandi ambienti dove viene richiesta ampia flessibilità e resa cromatica, ad esempio spazi MUSEALI, COMMERCIALI e RETAIL.



Articolo con UGR <19.

Sorgente	LED COB
Potenza	15W / 20W / 30W
Driver incluso	On/Off
Driver disponibili	No
Binario	3-Phase
CCT	3000 K / 4000 K
CRI	≥ 80 / ≥ 90
Durata LED	50.000h
Classe isolamento	II
IP	20
Materiale	Alluminio
Garanzia	5 anni



Link 3-Phase - Pagina 708





Smile 15W

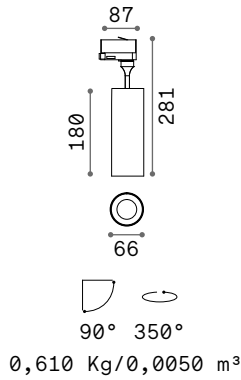

3-PHASE LED COB PHILIPS Driver TRIDONIC ON/OFF incluso

CRI ≥ 80

Potenza	Angolo	Lumen	CCT	Finitura	Codice	€
15W	24°	2050 lm	3000 K	Bianco	189574	120
				Nero	189581	120
		2250 lm	4000 K	Bianco	189611	120
				Nero	189628	120
	36°	2050 lm	3000 K	Bianco	189758	120
				Nero	189765	120
		2250 lm	4000 K	Bianco	189796	120
				Nero	189802	120
	50°	2050 lm	3000 K	Bianco	189932	120
				Nero	189949	120
		2250 lm	4000 K	Bianco	189956	120
				Nero	189963	120

CRI ≥ 90

Potenza	Angolo	Lumen	CCT	Finitura	Codice	€
15W	24°	1700 lm	3000 K	Bianco	189598	120
				Nero	189604	120
	36°	1700 lm	3000 K	Bianco	189772	120
				Nero	189789	120
	50°	1700 lm	3000 K	Bianco	189970	120
				Nero	189987	120



FILTER HONEYCOMB

SINGLE CONNECTION

Necessario	Driver	Finitura	Codice	€
No		Nero	189536	6
No	On/Off	Bianco	170145	23
		Nero	170152	23



Light beam: SPOT

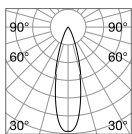

m	lx	cm
1	4362	0,47
2	1090	0,94
3	484	1,41
4	272	1,88
5	174	2,35



CRI ≥ 80 15W 24° 2050lm 3000K



Light beam: ACCENT

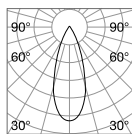

m	lx	cm
1	2923	0,64
2	730	1,29
3	324	1,94
4	182	2,58
5	116	3,23



CRI ≥ 80 15W 36° 2050lm 3000K



Light beam: WIDE

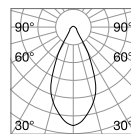

m	lx	cm
1	1611	0,89
2	402	1,79
3	179	2,69
4	100	3,59
5	64	4,49



CRI ≥ 80 15W 50° 2050lm 3000K



Smile 20W

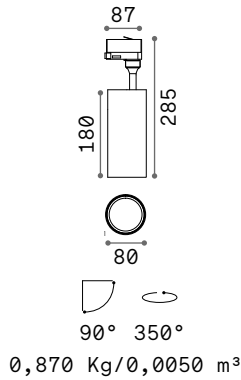

3-PHASE LED COB PHILIPS Driver TRIDONIC ON/OFF incluso

CRI ≥ 80

Potenza	Angolo	Lumen	CCT	Finitura	Codice	€
20 W	24°	3000 lm	3000 K	Bianco	189635	135
				Nero	189642	135
		3150 lm	4000 K	Bianco	189673	135
				Nero	189680	135
	36°	3000 lm	3000 K	Bianco	189819	135
				Nero	189826	135
		3150 lm	4000 K	Bianco	189857	135
				Nero	189864	135
	50°	3000 lm	3000 K	Bianco	189994	135
				Nero	190006	135
		3150 lm	4000 K	Bianco	190013	135
				Nero	190020	135

CRI ≥ 90

Potenza	Angolo	Lumen	CCT	Finitura	Codice	€
20 W	24°	2550 lm	3000 K	Bianco	189659	135
				Nero	189666	135
	36°	2550 lm	3000 K	Bianco	189833	135
				Nero	189840	135
	50°	2550 lm	3000 K	Bianco	190037	135
				Nero	190044	135



FILTER HONEYCOMB

SINGLE CONNECTION

Necessario	Driver	Finitura	Codice	€
No		Nero	190181	6
No	On/Off	Bianco	170145	23
		Nero	170152	23



Light beam: SPOT

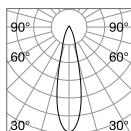

m	lx	cm
1	8787	0,42
2	2196	0,85
3	976	1,28
4	549	1,71
5	351	2,14



CRI ≥ 80 20W 24° 3000lm 3000K



Light beam: ACCENT

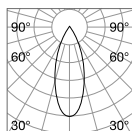

m	lx	cm
1	4526	0,64
2	1131	1,28
3	502	1,92
4	282	2,56
5	181	3,20



CRI ≥ 80 20W 36° 3000lm 3000K



Light beam: WIDE

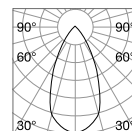

m	lx	cm
1	2657	0,93
2	664	1,87
3	295	2,81
4	166	3,75
5	106	4,69



CRI ≥ 80 20W 50° 3000lm 3000K



Smile 30W

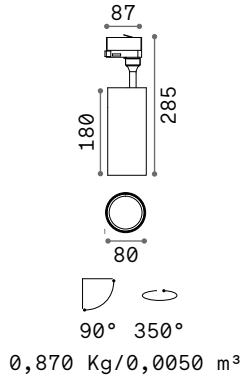

3-PHASE LED COB PHILIPS Driver TRIDONIC ON/OFF incluso

CRI ≥ 80

Potenza	Angolo	Lumen	CCT	Finitura	Codice	€
30 W	24°	4000 lm	3000 K	Bianco	189697	150
				Nero	189703	150
		4200 lm	4000 K	Bianco	189734	150
				Nero	189741	150
	36°	4000 lm	3000 K	Bianco	189871	150
				Nero	189888	150
		4200 lm	4000 K	Bianco	189895	150
				Nero	189901	150
	50°	4000 lm	3000 K	Bianco	190051	150
				Nero	190068	150
		4200 lm	4000 K	Bianco	190075	150
				Nero	190082	150

CRI ≥ 90

Potenza	Angolo	Lumen	CCT	Finitura	Codice	€
30 W	24°	3500 lm	3000 K	Bianco	189710	150
				Nero	189727	150
	36°	3500 lm	3000 K	Bianco	189918	150
				Nero	189925	150
	50°	3500 lm	3000 K	Bianco	190099	150
				Nero	190105	150



FILTER HONEYCOMB

SINGLE CONNECTION

Necessario	Driver	Finitura	Codice	€
No		Nero	190181	6
No	On/Off	Bianco	170145	23
		Nero	170152	23



Light beam: SPOT

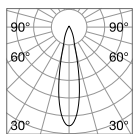

m	lx	cm
1	12955	0,39
2	3238	0,79
3	1439	1,19
4	809	1,59
5	518	1,99



CRI ≥ 80 30W 24° 4000lm 3000K



Light beam: ACCENT

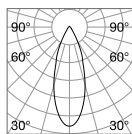

m	lx	cm
1	6240	0,62
2	1560	1,24
3	693	1,86
4	390	2,48
5	249	3,10



CRI ≥ 80 30W 36° 4000lm 3000K



Light beam: WIDE

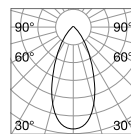

m	lx	cm
1	3740	0,88
2	935	1,76
3	415	2,65
4	233	3,53
5	149	4,42



CRI ≥ 80 30W 50° 4000lm 3000K



Fox new

Proiettore cilindrico in alluminio estruso, adatto per installazione su binario monofase e trifase LINK. Verniciatura a polveri in bianco, nero oppure ottone satinato, testata girevole 350° e orientabile fino a 90°. Disponibile anche in versione dimmerabile 1-10 V o DALI. Sorgente luminosa con tecnologia COB LED integrato, disponibile in tre diverse potenze con una temperatura di colore di 2700 K, 3000 K o 4000 K e con indice di resa cromatica CRI ≥ 80 o CRI ≥ 90 ; binning iniziale ≤ 3 Step MacAdam; fascio di apertura medio con ottiche accessorio a fascio stretto. Montaggio e smontaggio senza utensili. Protezione IP20; durata utile LED 50.000 h L70B50. Ideale per l'illuminazione di piccoli e medi ambienti dove vengono richiesti ampia flessibilità di disposizione, ad esempio in spazi COMMERCIALI e RETAIL, e un rapporto ottimale tra prestazioni e prezzo.

Sorgente	LED COB
Potenza	8W / 15W / 25W
Driver incluso	On/Off / 1-10V / DALI
Driver disponibili	No
Binario	3-Phase / 1-Phase
MacAdam	SDCM 3
CCT	2700 K / 3000 K / 4000 K
CRI	≥ 80 / ≥ 90
Durata LED	50.000 h
Classe isolamento	II
IP	20
Materiale	Alluminio
Garanzia	5 anni



Link 3-Phase - Pagina 708



Link 1-Phase - Pagina 714



Hot Drinks		Cold Drinks	
Espresso	1.30 - 2.00	Mineral Water	0.33 l. 2.00
Espresso macchiato	1.00 - 2.30	Afri Cola	0.2 l. 2.00
Americano	1.00	Spezialer Lemonade	0.33 l. 2.40
Cappuccino	2.10	... cherry, pear, coconut	
Caffè latte	2.20	Homemade Tiramisu - Dessert	0.33 l. 3.00
Flat White	2.00	Juice	0.2 l. 2.00
Chai Latte	2.00	... apple, nutmeg,	
Hot Chocolate	2.20	Juice w. sparkling Water	0.33 l. 2.80
Hot milk w. honey	2.00	orange juice	0.33 l. 2.40
Latte w. soy-milk		Lemonaid	0.33 l. 2.40
whipped cream		Club Mate	0.33 l. 2.20
		Homemade Gingerbeer (no alcohol)	0.35 l. 3.00
Acid-Mango-Zinger, Honey-Vanilla- Chamomile, Sticky-Times, Tension- Toner, Authentic Green, Black- Cherry-Berry, Apple-Gineman, Chai Bengal Spice			
Fresh Tea 2.50			
Ginger, Pfaff or Lemons			



Fox 8W

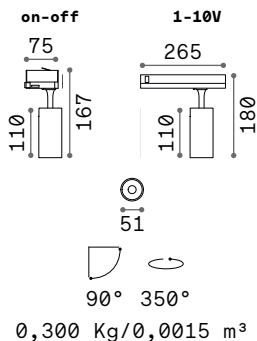

3-PHASE LED COB BRIDGELUX Driver incluso

CRI ≥ 80

Potenza	Angolo	Driver	Lumen	CCT	Finitura	Codice	€
8 W	41°	On-Off	1050 lm	3000 K	Bianco	250410	45
					Nero	250403	45
		1-10V	1100 lm	4000 K	Bianco	271453	45
					Nero	271446	45

CRI ≥ 90

Potenza	Angolo	Driver	Lumen	CCT	Finitura	Codice	€	
8 W	41°	On-Off	800 lm	2700 K	Bianco	340845	45 <small>new</small>	
					Nero	340838	45 <small>new</small>	
			950 lm	3000 K	Bianco	285368	45	
					Nero	285351	45	
				1000 lm	4000 K	Bianco	322339	45
						Nero	322322	45
		1-10V	900 lm	3000 K	Bianco	302546	85	
					Nero	302539	85	
			1050 lm	4000 K	Bianco	340869	85 <small>new</small>	
					Nero	340852	85 <small>new</small>	

1-PHASE LED COB BRIDGELUX Driver incluso

CRI ≥ 90

Potenza	Angolo	Driver	Lumen	CCT	Finitura	Codice	€
8 W	54°	On-Off	950 lm	3000 K	Nero	348308	35 <small>new</small>



LENS*



SINGLE CONNECTION

Modello	Necessario	Angolo	Driver	Finitura	Codice	€
On/Off	No	23°		Trasparen.	349121	5 <small>new</small>
				Trasparen.	302744	5
1-10V	No		On/Off	Bianco	170145	23
				Nero	170152	23



Light beam: ACCENT

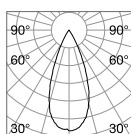

m	lx	Øm
1	2067	0,77
2	517	1,54
3	230	2,30
4	129	3,07
5	83	3,84



CRI ≥ 90 8W 41° 950lm 3000K

* La lente deve essere ordinata contestualmente al prodotto e verrà montata nel prodotto al posto della lente standard inclusa.



Fox 15W

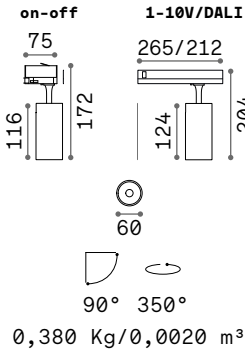

3-PHASE LED COB BRIDGELUX Driver incluso

CRI ≥ 80

Potenza	Angolo	Driver	Lumen	CCT	Finitura	Codice	€
15 W	41°	On-Off	1850 lm	3000 K	Bianco	250434	50
					Nero	250427	50
					Ottone	283937	55
			1900 lm	4000 K	Bianco	267784	50
					Nero	267777	50

CRI ≥ 90

Potenza	Angolo	Driver	Lumen	CCT	Finitura	Codice	€			
15 W	41°	On-Off	1450 lm	2700 K	Bianco	340883	50 <i>new</i>			
					Nero	340876	50 <i>new</i>			
			1600 lm	3000 K	Bianco	285382	50			
					Nero	285375	50			
					1750 lm	4000 K	Bianco	322360	50	
							Nero	322346	50	
		1-10V	1600 lm	3000 K	Bianco	302560	80			
					Nero	302553	80			
			1750 lm	4000 K	Bianco	340906	80 <i>new</i>			
					Nero	340890	80 <i>new</i>			
					DALI	1600 lm	3000 K	Bianco	302584	110
								Nero	302577	110
		1750 lm	4000 K	Bianco	340920	110 <i>new</i>				
				Nero	340913	110 <i>new</i>				

1-PHASE LED COB BRIDGELUX Driver incluso

CRI ≥ 90

Potenza	Angolo	Driver	Lumen	CCT	Finitura	Codice	€
15 W	39°	On-Off	1600 lm	3000 K	Nero	348315	40 <i>new</i>



LENS



SINGLE CONNECTION



Light beam: ACCENT

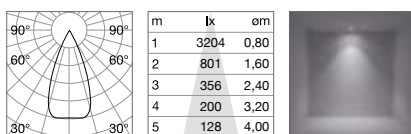

CRI ≥ 80 15W 41° 1850lm 3000K



Fox 25W

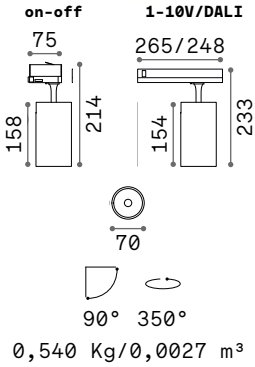

3-PHASE LED COB BRIDGELUX Driver incluso

CRI ≥ 80

Potenza	Angolo	Driver	Lumen	CCT	Finitura	Codice	€
25 W	35°	On-Off	2900 lm	3000 K	Bianco	250458	55
					Nero	250441	55
					Ottone	283944	60
			3050 lm	4000 K	Bianco	267807	55
					Nero	267791	55

CRI ≥ 90

Potenza	Angolo	Driver	Lumen	CCT	Finitura	Codice	€	
25 W	35°	On-Off	2800 lm	2700 K	Bianco	340944	55 <small>new</small>	
					Nero	340937	55 <small>new</small>	
			2950 lm	3000 K	Bianco	285405	55	
					Nero	285399	55	
			3000 lm	4000 K	Bianco	322391	55	
					Nero	322377	55	
		1-10V	2900 lm	3000 K	Bianco	302607	100	
					Nero	302591	100	
			3000 lm	4000 K	Bianco	340968	100 <small>new</small>	
					Nero	340951	100 <small>new</small>	
			DALI	2900 lm	3000 K	Bianco	302621	115
						Nero	302614	115
		3000 lm	4000 K	Bianco	340982	115 <small>new</small>		
				Nero	340975	115 <small>new</small>		

1-PHASE LED COB BRIDGELUX Driver incluso

CRI ≥ 90

Potenza	Angolo	Driver	Lumen	CCT	Finitura	Codice	€
25 W	35°	On-Off	2950 lm	3000 K	Nero	348322	45 <small>new</small>

Modello	Necessario	Angolo	Driver	Finitura	Codice	€
On/Off	No	15°		Trasparen.	349145	5 <small>new</small>
1-10V/DALI	No			Trasparen.	302768	5
	No		On/Off	Bianco	170145	23
	No			Nero	170152	23



LENS



SINGLE CONNECTION



Light beam: ACCENT

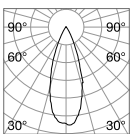

m	lx	Øm
1	8140	0,61
2	2035	1,22
3	904	1,82
4	509	2,43
5	326	3,04



CRI ≥ 90 25W 35° 2950lm 3000K



Eos ^{new}

Proiettore cilindrico in alluminio estruso con fascio di apertura variabile da stretto ad ampio (20°-55°), adatto per installazione su binario monofase o trifase LINK. Verniciatura a polveri in bianco o nero, testata girevole 355° e orientabile fino a 90°. Disponibile anche in versione dimmerabile 1-10 V o DALI. Sorgente luminosa con tecnologia COB LED integrato, disponibile in due diverse potenze con una temperatura di colore di 2700 K, 3000 K e 4000 K e con indice di resa cromatica ≥ 90 ; binning iniziale ≤ 3 Step MacAdam. Montaggio, smontaggio e regolazione dell'apertura del fascio senza utensili. Protezione IP20; durata utile LED 50.000 h L70B50. Ideale per l'illuminazione di grandi ambienti dove viene richiesta ampia flessibilità e alta resa cromatica, ad esempio aree ESPOSITIVE, spazi MUSEALI e RETAIL.

Sorgente	LED COB
Potenza	15W / 25W
Driver incluso	On/Off / 1-10V / DALI
Driver disponibili	No
Binario	3-Phase / 1-Phase
MacAdam	SDCM 3
CCT	2700 K / 3000 K / 4000 K
CRI	≥ 90
Durata LED	50.000 h
Classe isolamento	I - II
IP	20
Materiale	Alluminio
Garanzia	5 anni



Link 3-Phase - Pagina 708



Link 1-Phase - Pagina 714

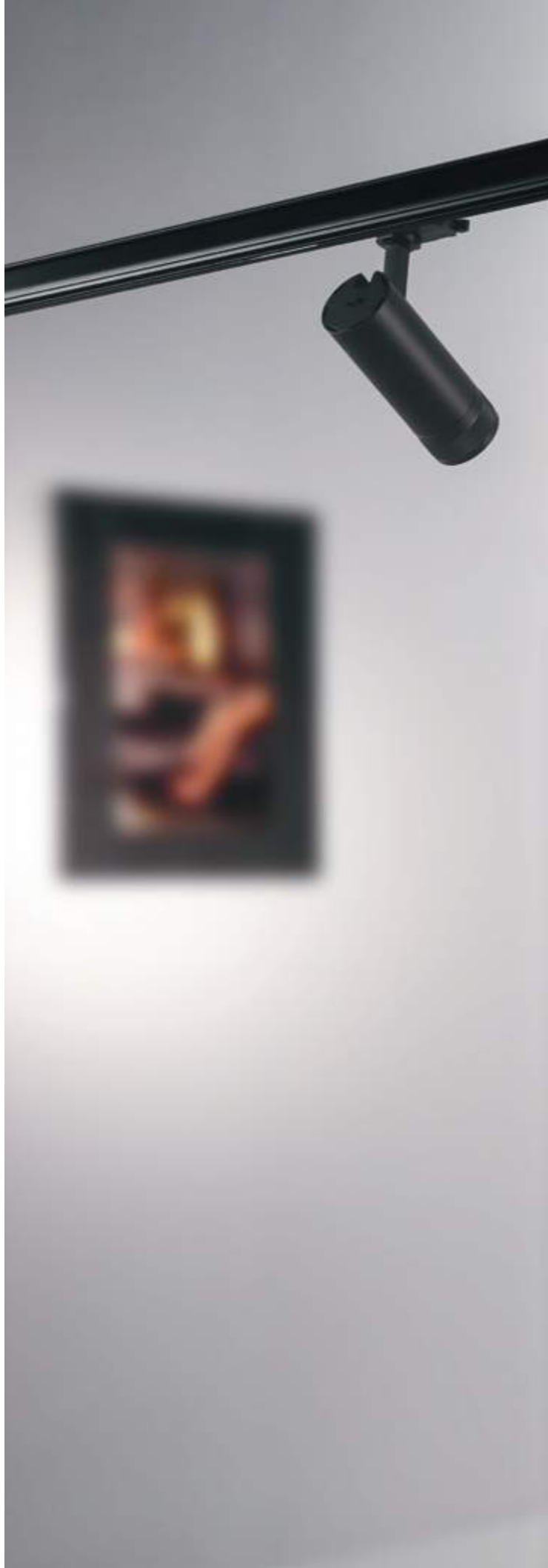

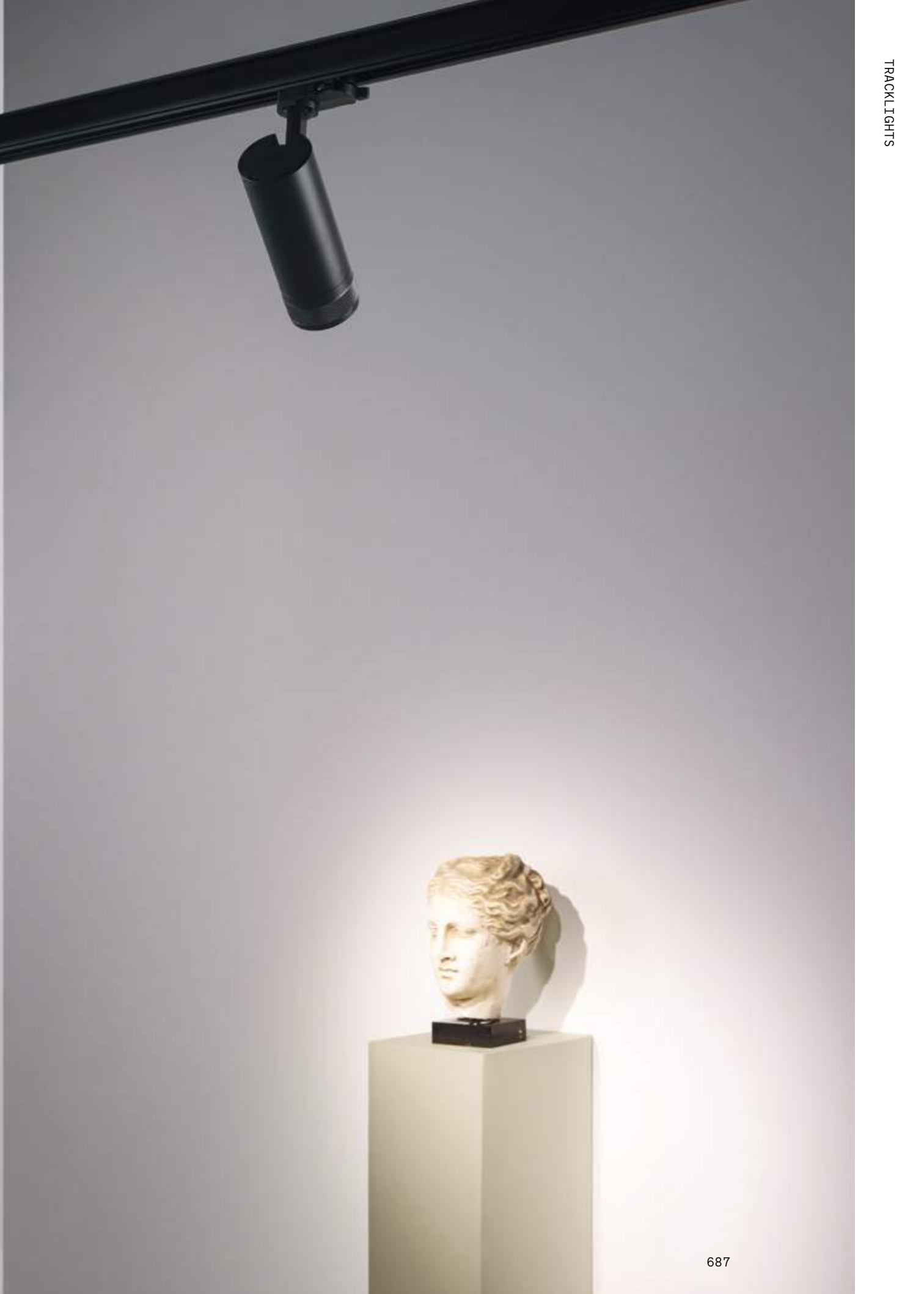

Eos 15W

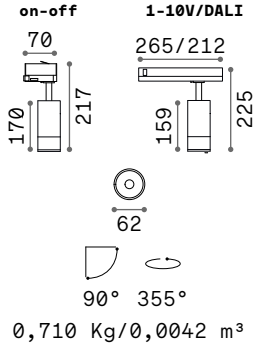

3-PHASE LED COB BRIDGELUX Driver incluso

Potenza	Angolo	Driver	Lumen	CCT	Finitura	Codice	€	
15 W	20-55°	On-Off	1400 lm	2700 K	Bianco	340807	73 <i>new</i>	
					Nero	340791	73 <i>new</i>	
			1450 lm	3000 K	Bianco	286594	73	
					Nero	276182	73	
			1650 lm	4000 K	Bianco	322094	73	
					Nero	322087	73	
		1-10V	1450 lm	3000 K	Bianco	302959	116	
					Nero	302942	116	
			DALI	1450 lm	3000 K	Bianco	302997	135
						Nero	302980	135

1-PHASE LED COB BRIDGELUX Driver incluso

Potenza	Angolo	Driver	Lumen	CCT	Finitura	Codice	€
15 W	20-55°	On-Off	1450 lm	3000 K	Nero	337579	65 <i>new</i>



SINGLE CONNECTION

Necessario	Driver	Finitura	Codice	€
No	On/Off	Bianco	170145	23
		Nero	170152	23



Light beam: from SPOT to WIDE

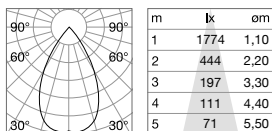

CRI≥90 15W 20-55° 1450lm 3000K



Eos 25W

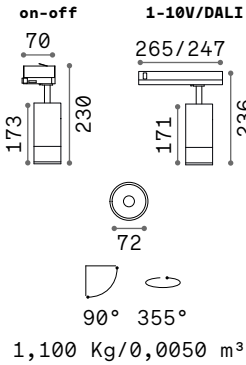

3-PHASE LED COB BRIDGELUX Driver incluso

Potenza	Angolo	Driver	Lumen	CCT	Finitura	Codice	€
25W	20-55°	On-Off	2450 lm	2700 K	Bianco	340821	92 <i>new</i>
					Nero	340814	92 <i>new</i>
			2500 lm	3000 K	Bianco	286600	92
					Nero	276243	92
			2650 lm	4000 K	Bianco	322124	92
					Nero	322100	92
		1-10V	2500 lm	3000 K	Bianco	302973	135
					Nero	302966	135
			2500 lm	3000 K	Bianco	303017	155
					Nero	303000	155

1-PHASE LED COB BRIDGELUX Driver incluso

Potenza	Angolo	Driver	Lumen	CCT	Finitura	Codice	€
25W	20-55°	On-Off	2500 lm	3000 K	Nero	342740	85 <i>new</i>



SINGLE CONNECTION

Necessario	Driver	Finitura	Codice	€
No	On/Off	Bianco	170145	23
		Nero	170152	23



Light beam: from SPOT to WIDE

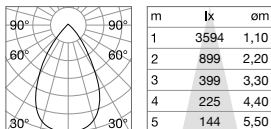

CRI≥90 25W 20-55° 2500lm 3000K



Pov



Sorgente	LED COB	CRI	≥95
Potenza	22W	Durata LED	30.000 h
Driver incluso	On/Off	Classe isolamento	II
Driver disponibili	No	IP	20
Binario	3-Phase	Materiale	Alluminio
MacAdam	SDCM 3	Garanzia	5 anni
CCT	3000 K		

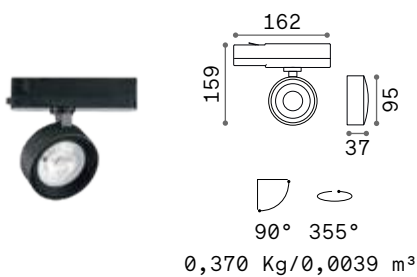

3-PHASE LED COB CREE Driver PHILIPS ON/OFF incluso

Potenza	Angolo	Lumen	CCT	Finitura	Codice	€
22 W	36°	2000 lm	3000 K	Bianco	296340	135
				Nero	296333	135

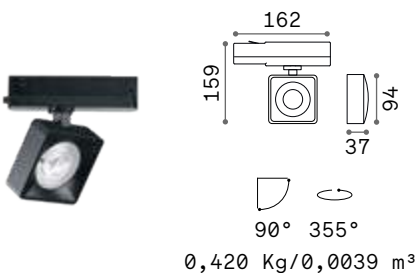

3-PHASE LED COB CREE Driver PHILIPS ON/OFF incluso

Potenza	Angolo	Lumen	CCT	Finitura	Codice	€
22 W	36°	2000 lm	3000 K	Bianco	296364	135
				Nero	296357	135



Link 3-Phase - Pagina 708



Light beam: ACCENT

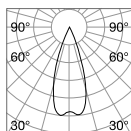

m	lx	Øm
1	3646	0,65
2	911	1,30
3	405	1,90
4	228	2,60
5	146	3,20



CRI≥95 22W 36° 1750lm 3000K

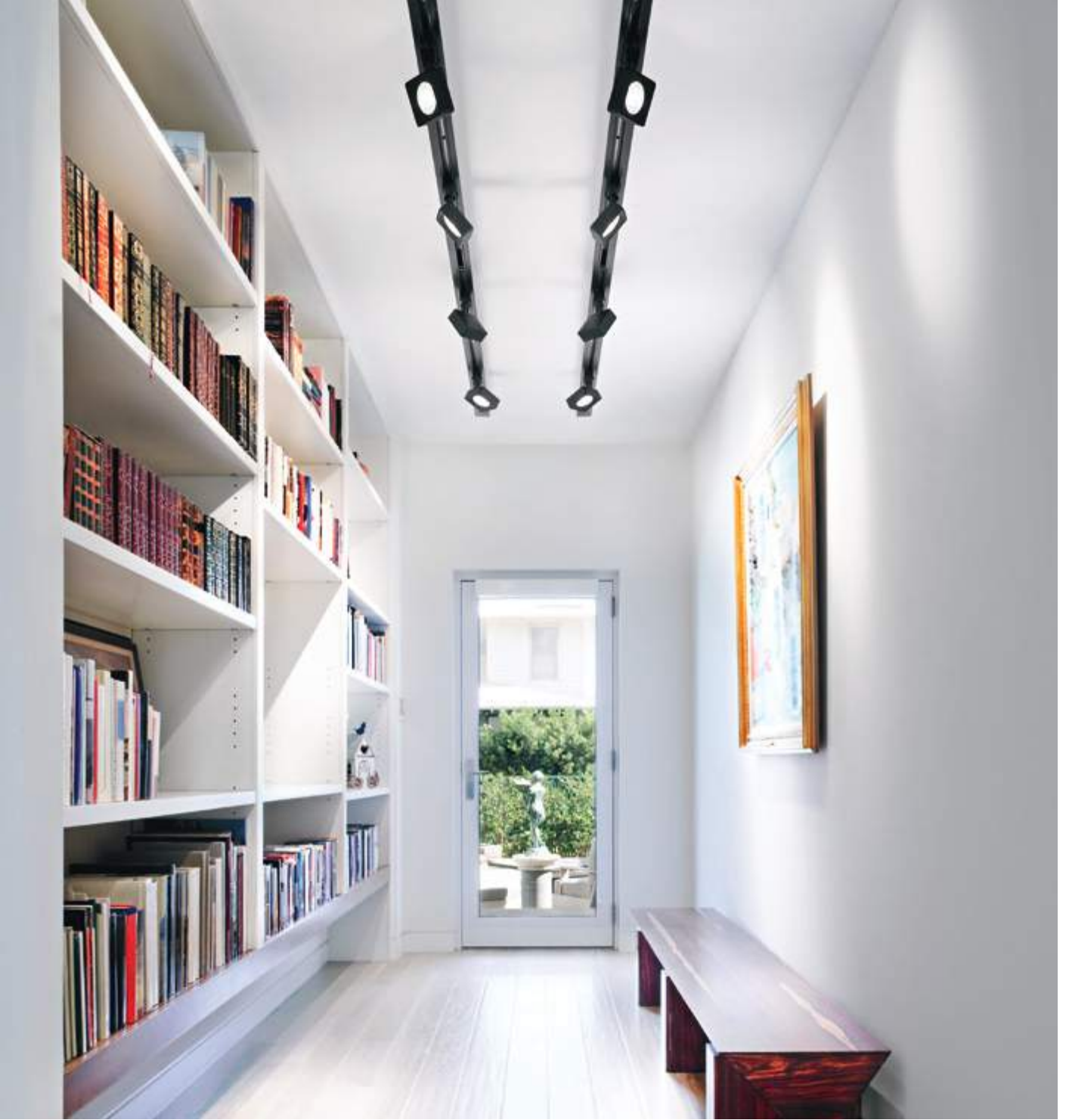



Spot - Mouse Track

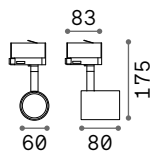

0,250 Kg/0,0016 m³

GU10 Non inclusa - Lampadina consigliata 108292

Potenza	Binario	Finitura	Codice	€
max 28W	3-Phase	Bianco	229706	47
		Nero	229720	47
	1-Phase	Nero	337517	47 new



P. 316



P. 412

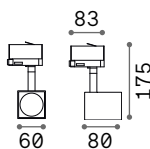

0,300 Kg/0,0027 m³

GU10 Non inclusa - Lampadina consigliata 108292

Potenza	Binario	Finitura	Codice	€
max 50W	3-Phase	Bianco	229768	44
		Nero	229782	44



P. 316



P. 412



SINGLE CONNECTION

Necessario	Driver	Finitura	Codice	€
No	On/Off	Bianco	170145	23
		Nero	170152	23



Link 3-Phase - Pagina 708



Link 1-Phase - Pagina 714



Glim Track

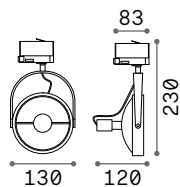

0,320 Kg/0,0180 m³

GU10 Lampadine LED GU10 10W 3000 K incluse. Cod. **189031**

IP20

Potenza	Binario	Finitura	Codice	€
max 50W	3-Phase	Bianco	229676	95
		Nero	229683	95



P. 321



SINGLE CONNECTION

Necessario	Driver	Finitura	Codice	€
No	On/Off	Bianco	170145	23
		Nero	170152	23



Link 3-Phase - Pagina 708



Byte

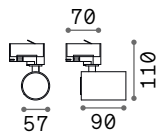

0,200 Kg/0,0013 m³

GU10 Lampadine LED GU10 7W 3000 K incluse. Cod. 123943



Potenza	Binario	Finitura		Codice	€
max 28W	3-Phase	Bianco		274508	36
		Nero		274515	36
	1-Phase	Nero		337524	36 <i>new</i>



SINGLE CONNECTION

Necessario	Driver	Finitura		Codice	€
No	On/Off	Bianco		170145	23
		Nero		170152	23



Link 3-Phase - Pagina 708



Link 1-Phase - Pagina 714



Spike new

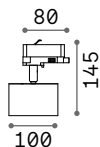

0,370 Kg/0,0027 m³

GX53 Lampadine LED GX53 9W 3000K CRI80 incluse. Cod. **123936**



Potenza	Binario	Finitura	Codice	€
max 9W	3-Phase	Bianco	344942	60 <small>new</small>
		Nero	336626	60 <small>new</small>



SINGLE CONNECTION

Necessario	Driver	Finitura	Codice	€
No	On/Off	Bianco	170145	23
		Nero	170152	23



P. 308



Link 3-Phase - Pagina 708





GU10 Lampadine LED GU10 7W 3000 K incluse. Cod. **123943**

Potenza	Binario	Finitura	Codice	€
max 28W	3-Phase	Bianco	 231662	80
		Nero	 231631	80

0,930 Kg/0,0037 m³



SINGLE CONNECTION

Necessario	Driver	Finitura	Codice	€
No	On/Off	Bianco	 170145	23
		Nero	 170152	23



Link 3-Phase - Pagina 708



Display ^{new}

Proiettore lineare in alluminio verniciato per binario trifase LINK, finitura bianca o nera, diffusore in PMMA. Disponibile nel modello WIDE diffondente, nel modello UGR microprismatizzato e nel modello ACCENT (UGR < 16). Tecnologia LED SMD, CCT 2700 K, 3000 K o 4000 K; CRI ≥ 90 , SDCM ≤ 3 ; durata utile LED 50.000 h L70B50.

PRO Prodotto ad alto contenuto tecnologico, elevata qualità dei materiali, destinato ad uso professionale.

UGR Articolo con UGR <16 (Accent), <22 (UGR).

Sorgente	LED SMD
Potenza	14W / 40W
Driver incluso	On/Off
Driver disponibili	No
Binario	3-Phase
MacAdam	SDCM 3
CCT	2700 K / 3000 K / 4000 K
CRI	≥ 90
UGR	<16 (Accent) / <22 (UGR)
Durata LED	50.000 h
Classe isolamento	II
IP	20
Materiale	Alluminio
Garanzia	5 anni



Link 3-Phase - Pagina 708



Display Accent

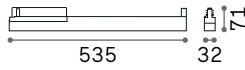

0,750 Kg/0,0035 m³

3-PHASE LED SMD SAMSUNG Driver ON/OFF incluso - UGR <16

Potenza	Angolo	Lumen	CCT	Finitura	Codice	€
14 W	60°	1250 lm	2700 K	Bianco	339894	242 new
				Nero	339887	242 new
		1350 lm	3000 K	Bianco	283593	242
				Nero	283609	242
		1600 lm	4000 K	Bianco	283616	242
				Nero	283623	242

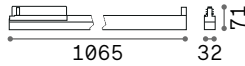

1,120 Kg/0,0112 m³

3-PHASE LED SMD SAMSUNG Driver ON/OFF incluso - UGR <16

Potenza	Angolo	Lumen	CCT	Finitura	Codice	€
28 W	60°	2700 lm	3000 K	Bianco	283524	380
				Nero	276267	380
		3200 lm	4000 K	Bianco	283531	380
				Nero	283548	380

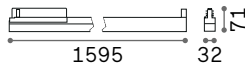

1,570 Kg/0,0173 m³

3-PHASE LED SMD SAMSUNG Driver ON/OFF incluso - UGR <16

Potenza	Angolo	Lumen	CCT	Finitura	Codice	€
42 W	60°	3750 lm	3000 K	Bianco	283555	525
				Nero	283562	525
		4350 lm	4000 K	Bianco	283579	525
				Nero	283586	525



Light beam: ACCENT

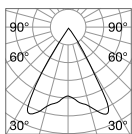

m	lx	øm
1	1330	1,20
2	332	2,40
3	148	3,50
4	83	4,70
5	53	5,90

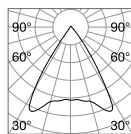

m	lx	øm
1	2453	1,30
2	613	2,50
3	273	3,80
4	153	5,00
5	96	6,30

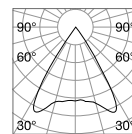

m	lx	øm
1	3598	1,30
2	900	2,50
3	400	3,80
4	225	5,00
5	144	6,30



CRI≥90 14W 60° 1350lm 3000K

CRI≥90 28W 60° 2700lm 3000K

CRI≥90 42W 60° 3750lm 3000K



Display Accent 535 mm



Display Accent 1065 mm



Display Accent 1595 mm



Display Wide

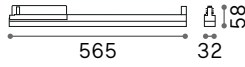

0,550 Kg/0,0035 m³

3-PHASE LED SMD SAMSUNG Driver ON/OFF incluso

Potenza	Angolo	Lumen	CCT	Finitura	Codice	€
21W	125°	2100 lm	2700 K	Bianco	340012	200 <small>new</small>
				Nero	340005	200 <small>new</small>
		2550 lm	3000 K	Bianco	283753	200
				Nero	283760	200
		2800 lm	4000 K	Bianco	276274	200
				Nero	283777	200

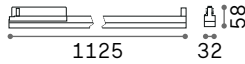

0,900 Kg/0,0047 m³

3-PHASE LED SMD SAMSUNG Driver ON/OFF incluso

Potenza	Angolo	Lumen	CCT	Finitura	Codice	€
40W	125°	4200 lm	2700 K	Bianco	340036	305 <small>new</small>
				Nero	340029	305 <small>new</small>
		4600 lm	3000 K	Bianco	283722	305
				Nero	283050	305
		5050 lm	4000 K	Bianco	283739	305
				Nero	283746	305



Light beam: WIDE

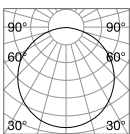

m	lx	Øm
1	473	5,20
2	118	6,50
3	53	9,70
4	30	13,00
5	19	16,00

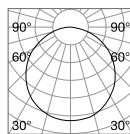
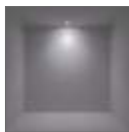

m	lx	Øm
1	897	3,10
2	224	6,10
3	100	9,20
4	56	12,00
5	36	15,00

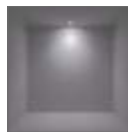

CRI≥80 21W 125° 2550lm 3000K

CRI≥80 40W 125° 4600lm 3000K



Display Wide 565 mm



Display Wide 1125 mm



Display UGR

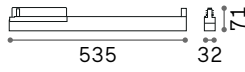

0,400 Kg/0,0064 m³

3-PHASE LED SMD SAMSUNG Driver ON/OFF incluso - UGR <22

Potenza	Angolo	Lumen	CCT	Finitura	Codice	€
14 W	70°	1750 lm	3000 K	Bianco	283685	212
				Nero	283692	212
		1800 lm	4000 K	Bianco	283708	212
				Nero	283715	212

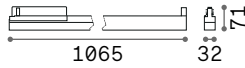

1,120 Kg/0,0112 m³

3-PHASE LED SMD SAMSUNG Driver ON/OFF incluso - UGR <22

Potenza	Angolo	Lumen	CCT	Finitura	Codice	€
25 W	70°	3550 lm	3000 K	Bianco	283647	335
				Nero	283630	335
		3650 lm	4000 K	Bianco	276281	335
				Nero	283258	335

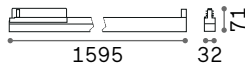

1,570 Kg/0,0173 m³

3-PHASE LED SMD SAMSUNG Driver ON/OFF incluso - UGR <22

Potenza	Angolo	Lumen	CCT	Finitura	Codice	€
40 W	70°	5350 lm	3000 K	Bianco	283654	470
				Nero	283067	470
		5500 lm	4000 K	Bianco	283661	470
				Nero	283678	470



Light beam: WIDE

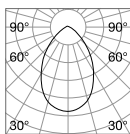

m	lx	Øm
1	854	1,40
2	213	2,80
3	95	4,20
4	53	5,70
5	34	7,10

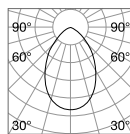
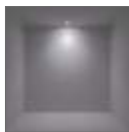

m	lx	Øm
1	1636	1,40
2	409	2,80
3	182	4,20
4	102	5,70
5	65	7,10

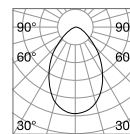
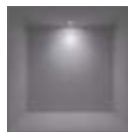

m	lx	Øm
1	2419	1,40
2	605	2,80
3	269	4,20
4	151	5,70
5	97	7,10

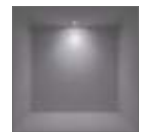

CRI≥90 14W 70° 1750lm 3000K

CRI≥90 25W 70° 3550lm 3000K

CRI≥90 40W 70° 5350lm 3000K

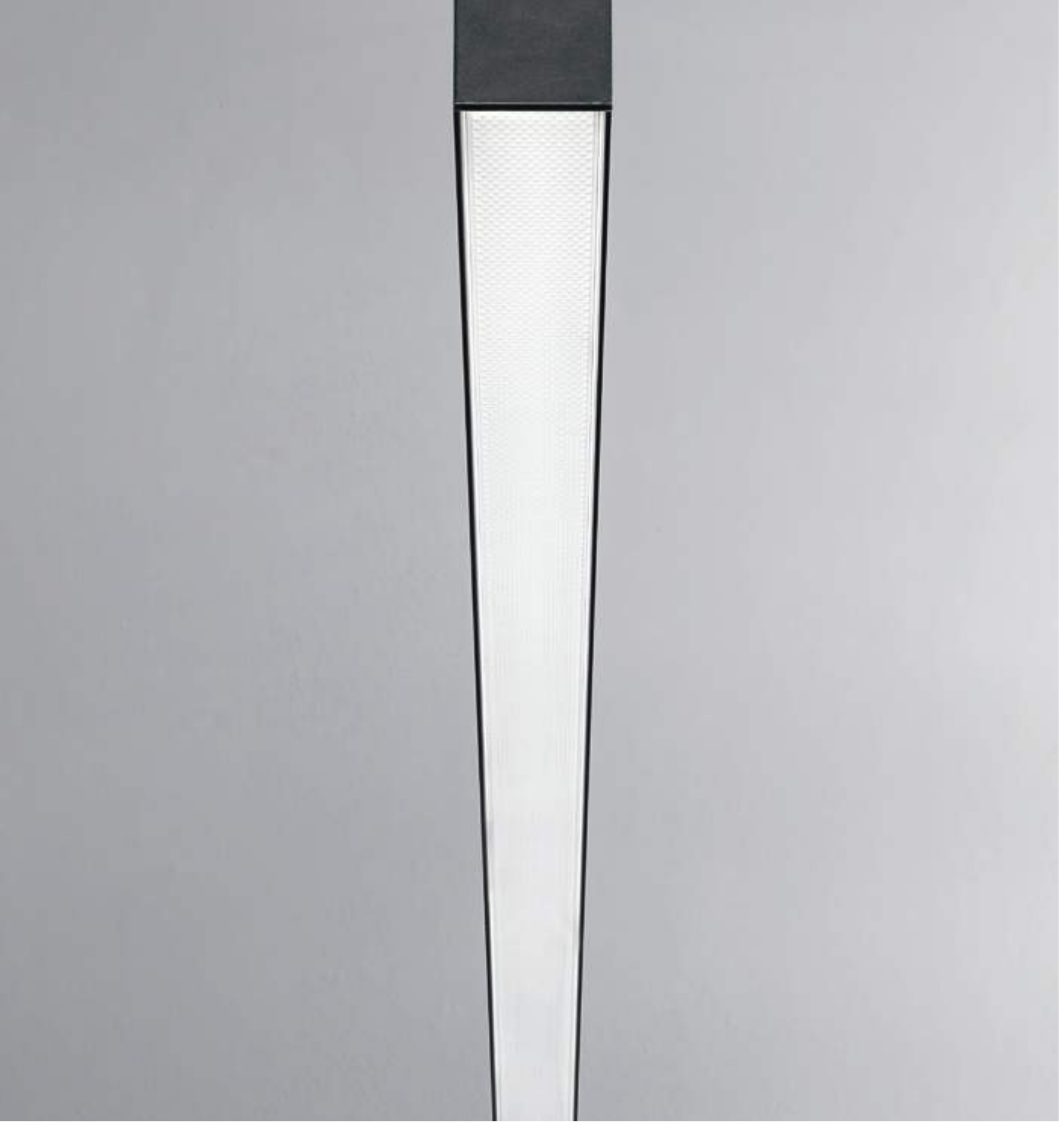

Display UGR 535 mm



Display UGR 1065 mm



Display UGR 1595 mm



Link 3-Phase

Binario elettrificato trifase con profilo di alluminio estruso; verniciatura a polveri in bianco o nero, ottimizzato per proiettori standard 3-Phase o equivalenti; disponibile nelle versioni a plafone, a sospensione oppure a incasso con bordo su soffitti di cartongesso; adatto a sistemi di file continue, moduli standard da 1000 mm, 2000 mm o 3000 mm. Ideale per l'installazione in grandi ambienti dove sono richieste flessibilità e lunghe distanze di connessione, ad esempio spazi MUSEALI, COMMERCIALI e RETAIL.

Classe isolamento	I
IP	20





Link 3-Phase Trimless On/Off

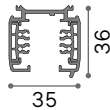
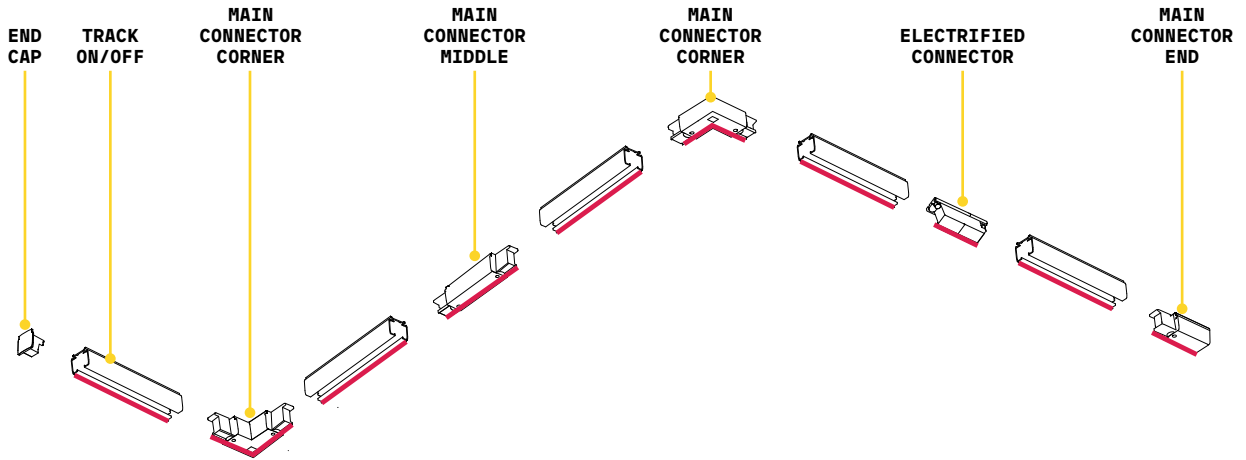

TRACK

Lunghezza	Peso	Volume	Finitura	Codice	€
1000 mm	0,94 Kg	0,0016 m ³	Bianco	243269	30
			Nero	243252	30
2000 mm	1,72 Kg	0,0074 m ³	Bianco	187976	60
			Nero	187983	60
3000 mm	2,55 Kg	0,0110 m ³	Bianco	187990	95
			Nero	188003	95



KIT SURFACE



SUSPENSION KIT



END CAP

Necessario	N° Cavi	Lunghezza cavi	Finitura	Codice	€
SI - 1Kit x 1000 mm			Bianco	169972	5
			Nero	169989	5
SI - 1Kit x 1000 mm	1	3000 mm	Bianco	242705	13
			Nero	243283	13
	1	5000 mm	Bianco	243245	15
			Nero	243238	15
SI			Bianco	169613	2
			Nero	169620	2



MAIN CONNECTOR END

0,060 Kg/0,0002 m³

169583	L	€ 9
169576	R	€ 9
169590	R	€ 9
169606	R	€ 9

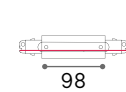

MAIN CONNECTOR MIDDLE

0,120 Kg/0,0004 m³

227580	€ 17
227597	€ 17

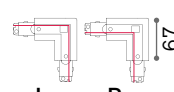

MAIN CONNECTOR CORNER

0,110 Kg/0,0005 m³

169705	L	€ 17
169712	L	€ 17
169736	R	€ 17
169729	R	€ 17

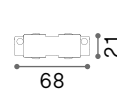

ELECTRIFIED CONNECTOR

0,030 Kg/0,0001 m³

169637	€ 7
169644	€ 7

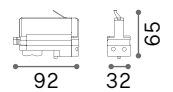

TRACK ADAPTOR

0,080 Kg/0,0002 m³

194257	€ 9
194301	€ 9

Link 3-Phase Trimless DALI - 1-10V

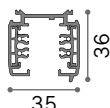
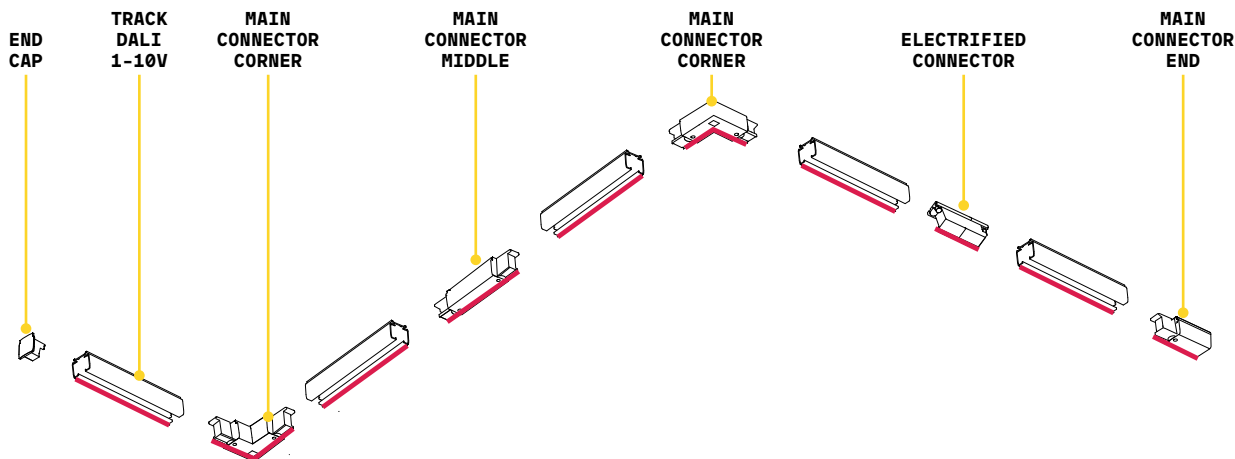

TRACK

Lunghezza	Peso	Volume	Finitura	Codice	€
1000 mm	0,94 Kg	0,0016 m³	Bianco	246468	38
			Nero	246451	38
2000 mm	1,93 Kg	0,0032 m³	Bianco	247007	80
			Nero	246901	80
3000 mm	2,87 Kg	0,0048 m³	Bianco	247625	115
			Nero	247618	115



KIT SURFACE



SUSPENSION KIT



END CAP

Necessario	N° Cavi	Lunghezza cavi	Finitura	Codice	€
SI - 1 Kit x 1000 mm			Bianco	169972	5
			Nero	169989	5
SI - 1 Kit x 1000 mm	1	3000 mm	Bianco	242705	13
			Nero	243283	13
	1	5000 mm	Bianco	243245	15
			Nero	243238	15
SI			Bianco	169613	2
			Nero	169620	2

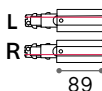

MAIN CONNECTOR END

0,079 Kg/0,0002 m³

246529	L	€ 13
246512	R	€ 13
246543	R	€ 13
246536	R	€ 13

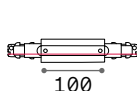

MAIN CONNECTOR MIDDLE

0,129 Kg/0,0004 m³

246581	€ 25
246574	€ 25

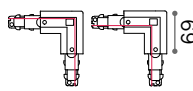

MAIN CONNECTOR CORNER

0,130 Kg/0,0006 m³

246604	L	€ 25
246598	R	€ 25
246628	R	€ 25
246611	R	€ 25

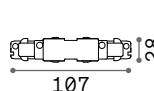

ELECTRIFIED CONNECTOR

0,050 Kg/0,0001 m³

246567	€ 9
246550	€ 9



TRACK ADAPTOR

0,063 Kg/0,0003 m³

246505	€ 15
246499	€ 15

Link 3-Phase Trim On/Off

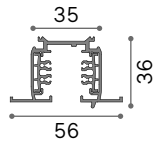
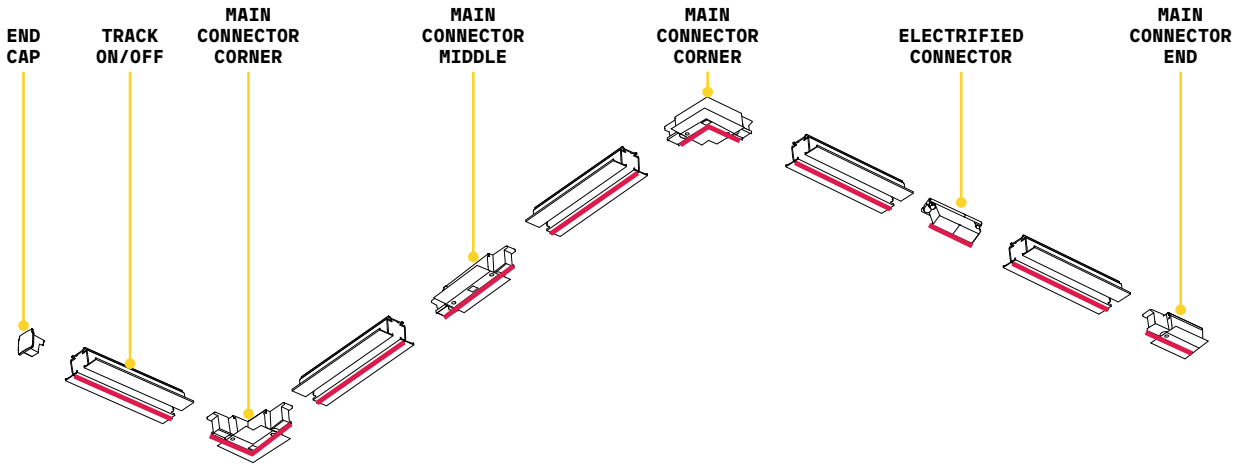

TRACK

Lunghezza	Peso	Volume	Finitura	Codice	€
2000 mm	1,92 Kg	0,0132 m ³	Bianco	188010	60
			Nero	188027	60



KIT RECESSED
END CAP

Necessario	Finitura	Codice	€
SI - 1 Kit x 1000 mm	Alluminio	188195	5
SI	Bianco	169613	2
	Nero	169620	2

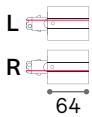

MAIN CONNECTOR END

0,070 Kg/0,0002 m³

188072	L	€ 7
188089	R	€ 7
188058	L	€ 7
188065	R	€ 7

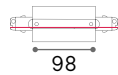

MAIN CONNECTOR MIDDLE

0,130 Kg/0,0004 m³

227689	€ 15
227672	€ 15

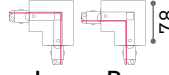

MAIN CONNECTOR CORNER

0,120 Kg/0,0006 m³

188119	L	€ 15
188126	R	€ 15
188096	L	€ 15
188102	R	€ 15

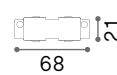

ELECTRIFIED CONNECTOR

0,030 Kg/0,0001 m³

169637	€ 7
169644	€ 7

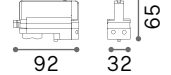

TRACK ADAPTOR

0,080 Kg/0,0002 m³

194257	€ 9
194301	€ 9

Link 3-Phase Trim DALI - 1-10V

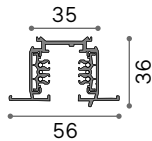
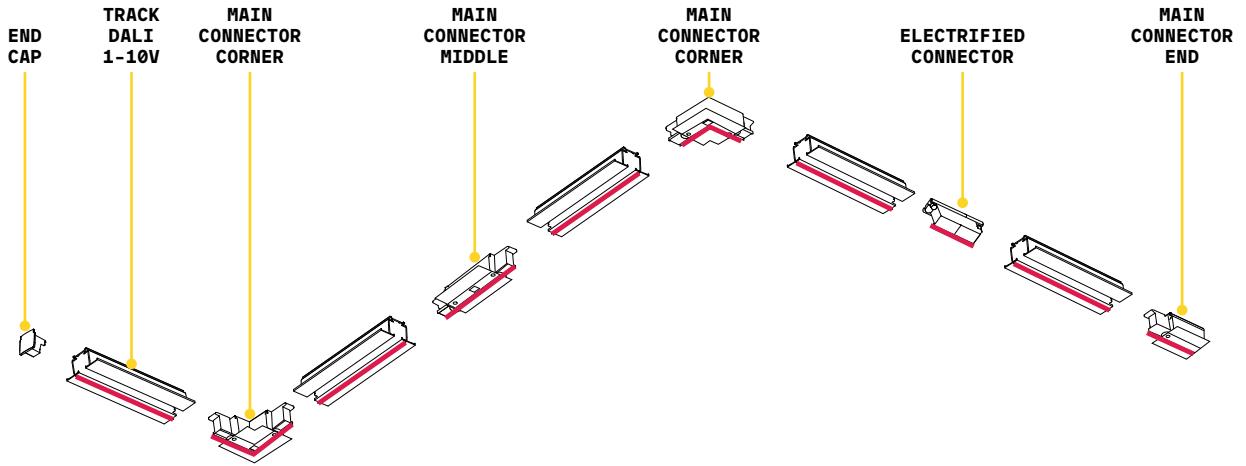

TRACK

Lunghezza	Peso	Volume	Finitura	Codice	€
2000 mm	2,11 Kg	0,0048 m ³	Bianco	246895	75
			Nero	249629	75



**KIT RECESSED
END CAP**

Necessario	Finitura	Codice	€
SI - 1 Kit x 1000 mm	Alluminio	188195	6
SI	Bianco	169613	2
	Nero	169620	2

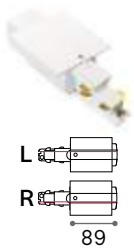

**MAIN CONNECTOR
END**

0,089 Kg/0,0004 m³

256085	L	€ 10
256078	R	€ 10
256146	R	€ 10
256122	R	€ 10

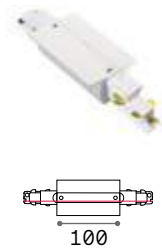

**MAIN CONNECTOR
MIDDLE**

0,150 Kg/0,0005 m³

256115	€ 25
256092	€ 25

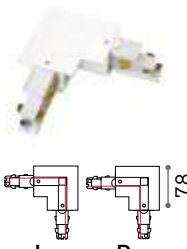

**MAIN CONNECTOR
CORNER**

0,150 Kg/0,0006 m³

256030	L	€ 25
255996	R	€ 25
256061	R	€ 25
256047	R	€ 25

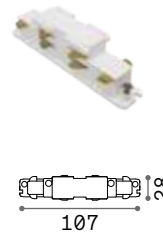

**ELECTRIFIED
CONNECTOR**

0,050 Kg/0,0001 m³

246567	€ 9
246550	€ 9

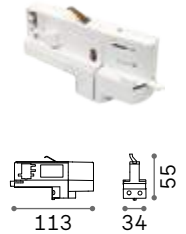

TRACK ADAPTOR

0,063 Kg/0,0003 m³

246505	€ 15
246499	€ 15

Link 1-Phase **new**

Binario elettrificato monofase con profilo di alluminio estruso; verniciatura a polveri in finitura nera; disponibile nelle versioni a plafone oppure a incasso con bordo su soffitti di cartongesso; adatto a sistemi di file continue, moduli standard da 1000 mm, 2000 mm o 3000 mm. Ideale per l'installazione in ambienti dove viene richiesta flessibilità e compattezza, ad esempio spazi RESIDENZIALI, COMMERCIALI e RETAIL.

Classe isolamento I
IP 20

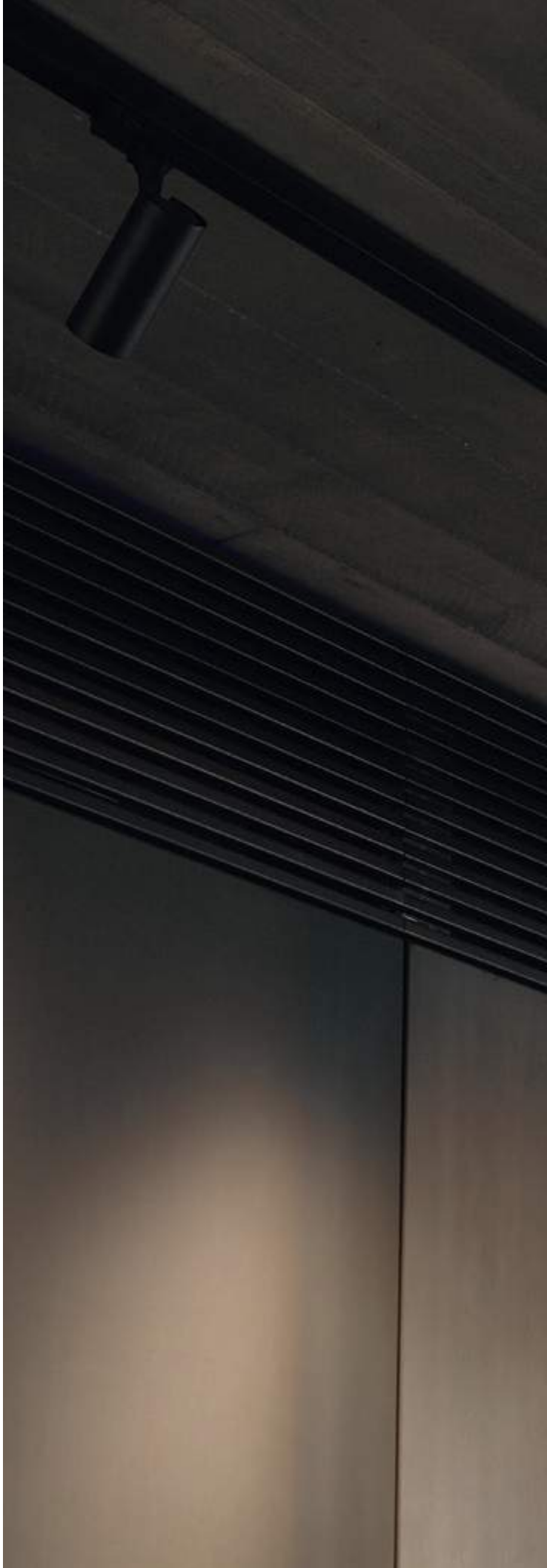



Link 1-Phase Surface On/Off

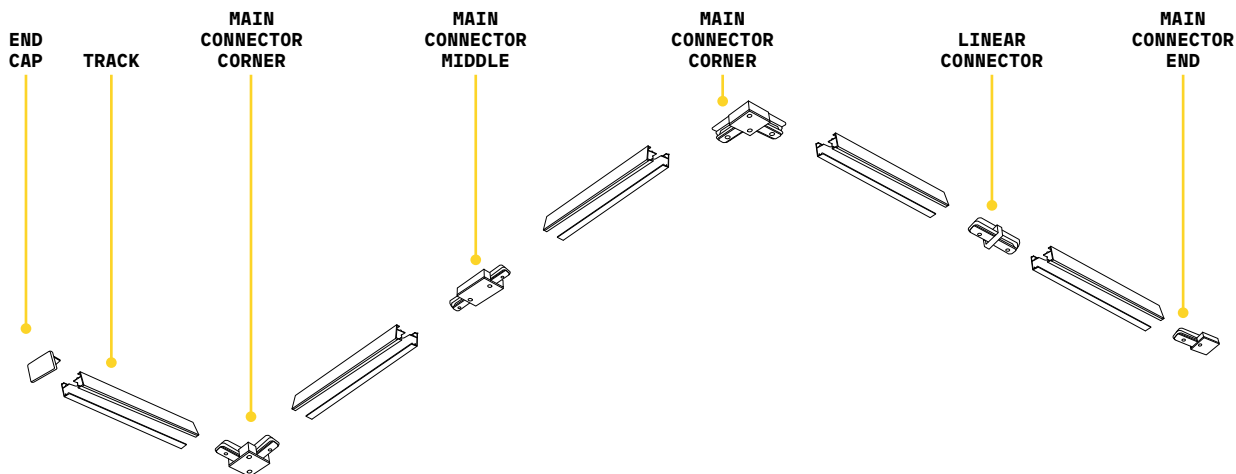

TRACK Kit di montaggio non necessario, fissaggio diretto a soffitto.

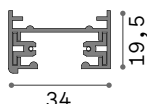

Lunghezza	Peso	Volume	Finitura	Codice	€
1000 mm	0,42 Kg	0,0007 m ³	Nero	337371	13 new
2000 mm	0,83 Kg	0,0017 m ³	Nero	342801	24 new
3000 mm	1,22 Kg	0,0022 m ³	Nero	344973	35 new



END CAP

Necessario	Finitura	Codice	€
SI	Nero	337395	3 new

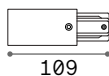

MAIN CONNECTOR

0,060 Kg/0,0001 m³

337388 ■ € 3 **new**

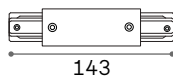

MAIN CONNECTOR MIDDLE

0,070 Kg/0,0001 m³

337425 ■ € 5 **new**

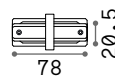

LINEAR CONNECTOR

0,040 Kg/0,0001 m³

337418 ■ € 3 **new**

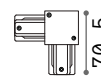

MAIN CONNECTOR CORNER

0,060 Kg/0,0001 m³

337401 ■ € 3 **new**

Link 1-Phase Recessed On/Off

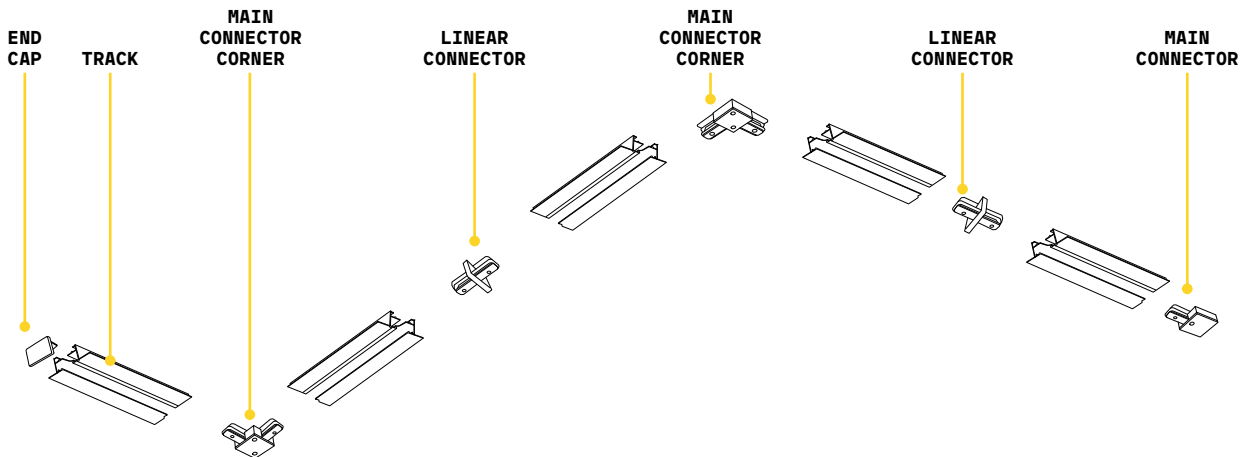

TRACK

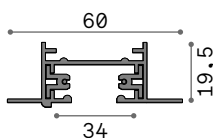

Lunghezza	Peso	Volume	Finitura	Codice	€
1000 mm	0,49 Kg	0,0013 m ³	Nero	342818	17 <i>new</i>
2000 mm	0,94 Kg	0,0027 m ³	Nero	342825	32 <i>new</i>
3000 mm	1,39 Kg	0,0041 m ³	Nero	344966	47 <i>new</i>



KIT RECESSED
END CAP

Necessario	Finitura	Codice	€
SI - 1 Kit x 1000 mm	Alluminio	188195	6
SI	Nero	337395	3 <i>new</i>

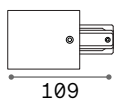

MAIN CONNECTOR

0,070 Kg/0,0001 m³
342832 ■ € 3 *new*

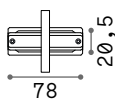

LINEAR CONNECTOR

0,040 Kg/0,0001 m³
342856 ■ € 3 *new*

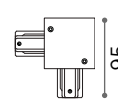

MAIN CONNECTOR CORNER

0,100 Kg/0,0001 m³
342849 ■ € 4 *new*



























Lampade da incasso

Interni

Indice alfabetico

Basic	770
Bento	728
Blues	796
Deep	768
Dynamic	734
Funky	794
Game	742
Groove	776
Jazz	794
Led Panel	782
Lika	784
Lounge	794
Nova	780
Off	764
One	756
Play	778
Polka	797
Quark	760
Room-65	795
Samba	792
Swing	794
Tag	754
Virus	758
Walky	799
Zephyr	798
Zeus	720

Indice icone

				
Zeus 720	Bento 728	Dynamic 734	Game 742	Tag 754
				
One 756	Virus 758	Quark 760	Off 764	Deep 768
				
Basic 770	Groove 776	Play 778	Nova 780	Led Panel 782
				
Lika 784	Samba 792	Jazz 794	Swing 794	Lounge 794
				
Funky 794	Room-65 795	Blues 796	Polka 797	Zephyr 798
				
Walky 799				

Zeus

Sistema componibile di elementi ad incasso costituito da sorgente orientabile, riflettore e ghiera rotonda o quadrata, con lenti e accessori schermanti in opzione; finitura bianca e nera; ghiera disponibile in versione TRIM con cornice o TRIMLESS senza cornice per installazione in controsoffitti in cartongesso; due diversi angoli di emissione a scelta. Sorgente luminosa con tecnologia COB LED integrato, disponibile con una temperatura di colore di 2700 K, 3000 K o 4000K ed elevata resa cromatica CRI ≥ 90 ; classe isolamento II; durata utile LED 50.000 h L70B50. Disponibile anche in versione dimmerabile 1-10V, DALI e PUSH. Adatto nelle installazioni di ambienti interni del TERZIARIO e RETAIL.

PRO

Prodotto ad alto contenuto tecnologico, elevata qualità dei materiali, destinato ad uso professionale.

UGR

Articolo con UGR <19.

Sorgente	LED COB
Potenza	13W / 21W
Driver incluso	On/Off
Driver disponibili	1-10V / DALI / Push
MacAdam	SDCM 3
CCT	2700 K / 3000 K / 4000 K
CRI	≥ 90
UGR	<19
Durata LED	50.000 h
Classe isolamento	II
IP	20
Materiale	Alluminio
Garanzia	5 anni





SORGENTE 13W/21W

LENTE 20°

FILTRO HONEYCOMB

RIFLETTORE ROUND/SQUARE

GHIERA TRIM ROUND/SQUARE

GHIERA TRIMLESS ROUND/SQUARE

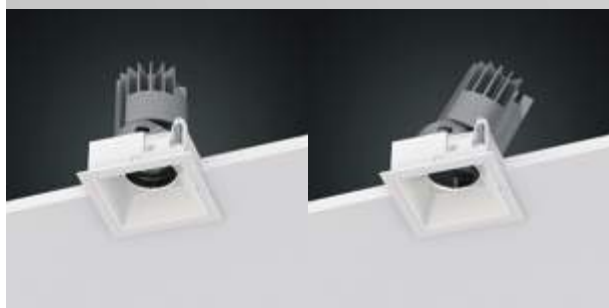

LENS 20°



FILTER HONEYCOMB

Necessario	Modello	Finitura	Codice	€
No	13 W	Trasparen.	323688	4
	21 W	Trasparen.	323985	6
No	13 W	Nero	323671	4
	21 W	Nero	323961	6

Zeus - Source

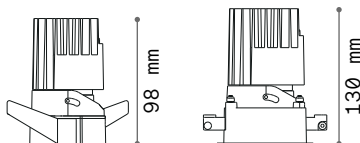

0,300 Kg/0,0014 m³

LED COB CITIZEN Necessario - Driver ON/OFF incluso

Potenza	Angolo	Lumen	CCT	Finitura	Codice	€
13W	40°	980 lm	2700 K	Grigio	324807	65
		1020 lm	3000 K	Grigio	324814	65
		1050 lm	4000 K	Grigio	324821	65

DIMMABLE DRIVER* Optional

Potenza	Output	Misura (LxHxP)	Codice	€	
1-10V	21W	350 mA	122x25x40 mm	324906	25
DALI/Push	20W	350 mA	120x29x51 mm	324913	70

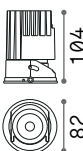

0,590 Kg/0,0029 m³

LED COB CITIZEN Necessario - Driver ON/OFF incluso

Potenza	Angolo	Lumen	CCT	Finitura	Codice	€
21W	40°	1900 lm	2700 K	Grigio	324838	105
		2000 lm	3000 K	Grigio	324845	105
		2200 lm	4000 K	Grigio	324852	105

DIMMABLE DRIVER* Optional

Potenza	Output	Misura (LxHxP)	Codice	€	
1-10V/Push	20W	500 mA	110x22x52 mm	324920	60
DALI/Push	20W	500 mA	120x29x51 mm	324937	70



Light beam: ACCENT

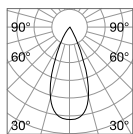

m	lx	Øm
1	1714	0,76
2	429	1,50
3	190	2,30
4	107	3,10
5	69	3,80



CRI≥90 13W 40° 1020lm 3000K

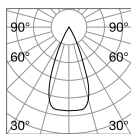

m	lx	Øm
1	3174	0,81
2	794	1,60
3	353	2,40
4	198	3,20
5	127	4,00



CRI≥90 21W 40° 2000lm 3000K

* Gli alimentatori dimmerabili devono essere ordinati contestualmente al prodotto e verranno già inclusi all'interno degli apparecchi in sostituzione degli alimentatori on-off.
** Lente 40° inclusa.

Zeus Round

FRAME TRIM

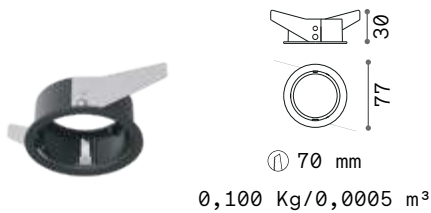

13 W			
Finitura		Codice	€
Bianco		324869	15
Nero		323527	15

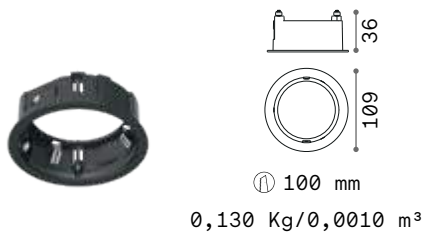

21W			
Finitura		Codice	€
Bianco		324883	18
Nero		324005	18

FRAME TRIMLESS

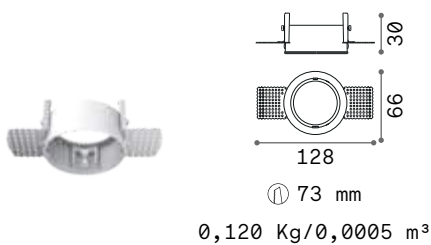

13 W			
Finitura		Codice	€
Bianco		323541	18

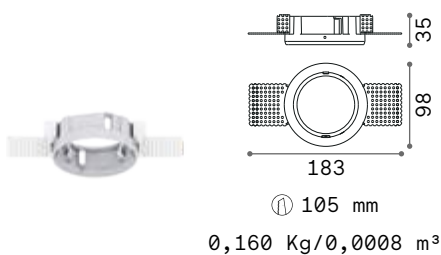

21W			
Finitura		Codice	€
Bianco		323725	35

REFLECTOR Necessario



13 W			
Finitura		Codice	€
Bianco		323589	8
Nero		323619	8
Oro		323602	8

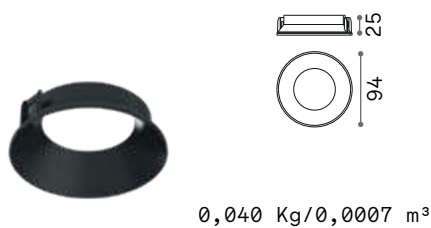

21W			
Finitura		Codice	€
Bianco		323763	12
Nero		323770	12
Oro		323794	12



Zeus Square

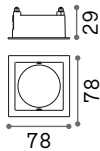

68 x 68 mm
0,100 Kg/0,0005 m³

FRAME TRIM

13 W

Finitura	Codice	€
Bianco	324876	15
Nero	323534	15

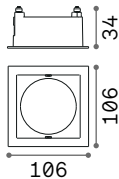

96 x 96 mm
0,130 Kg/0,0010 m³

21W

Finitura	Codice	€
Bianco	324890	18
Nero	323718	18

FRAME TRIMLESS

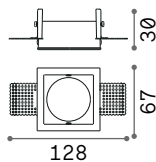

68 x 68 mm
0,120 Kg/0,0005 m³

13 W

Finitura	Codice	€
Bianco	323558	18

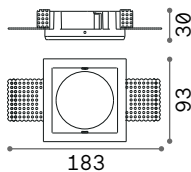

96 x 96 mm
0,160 Kg/0,0008 m³

21W

Finitura	Codice	€
Bianco	323732	35

REFLECTOR Necessario

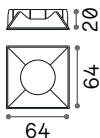

0,030 Kg/0,0003 m³

13 W

Finitura	Codice	€
Bianco	323633	8
Nero	323657	8
Oro	323640	8

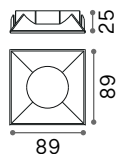

0,050 Kg/0,0007 m³

21W

Finitura	Codice	€
Bianco	323800	12
Nero	323817	12
Oro	323831	12



Bento

Sistema componibile di elementi ad incasso costituito da sorgente orientabili, riflettore e ghiera, con lenti e accessori schermanti in opzione; finitura bianca e nera; ghiera a incasso disponibile in forma singola rotonda o quadrata, oppure rettangolare in versione doppia o tripla per l'installazione di sorgenti multiple e indipendenti; anello anti-abbagliamento opzionale per arretramento della sorgente in modalità non orientabile; tre diversi angoli di emissione a scelta. Sorgente luminosa con tecnologia COB LED integrato per la massima efficienza, disponibile con una temperatura di colore di 3000 K; LED ad efficienza energetica ad elevata resa cromatica; CRI ≥ 90 ; binning iniziale ≤ 3 -Step MacAdam; classe isolamento II; durata utile LED 50.000 h L70B50. Disponibile in versione dimmerabile sia DALI che 1-10V. Per la sua dimensione compatta e grande versatilità è ottimale nelle installazioni di ambienti interni DOMESTICI, DIREZIONALI e RETAIL.

PRO

Prodotto ad alto contenuto tecnologico, elevata qualità dei materiali, destinato ad uso professionale.

UGR

Articolo con UGR <19.

Sorgente	LED COB
Potenza	9W / 13W
Driver incluso	On/Off
Driver disponibili	1-10V / DALI / Push
MacAdam	SDCM 3
CCT	3000 K
CRI	≥ 90
UGR	<19
Durata LED	50.000 h
Classe isolamento	II
IP	20
Materiale	Alluminio
Garanzia	5 anni







LENS

Necessario	Angolo	Finitura	Codice	€
No	18°	Trasparen.	287942	4
	45°	Trasparen.	279626	4
No		Nero	279718	4
No		Nero	279725	3
No		Bianco	288147	3
		Nero	279695	3



FILTER HONEYCOMB



DIFFUSER



ANTI-GLARE RING

Bento - Source

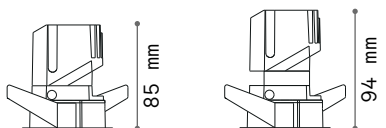

with anti-glare ring

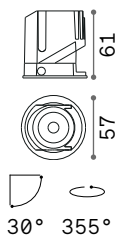

0,400 Kg/0,0030 m³

LED COB CITIZEN Necessario - Driver TRIDONIC ON/OFF incluso

Potenza	Angolo	Lumen	CCT	Finitura	Codice	€
9W	36°	750 lm	3000 K	Nero	279596	45

DIMMABLE DRIVER* Optional

	Potenza	Output	Misura (LxHxP)	Codice	€
1-10V	12 W	250 mA	122x25x40 mm	287843	35
DALI / Push	20 W	250 mA	120x29x51 mm	287850	87

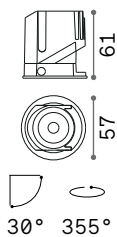

0,400 Kg/0,0030 m³

LED COB CITIZEN Necessario - Driver TRIDONIC ON/OFF incluso

Potenza	Angolo	Lumen	CCT	Finitura	Codice	€
13 W	36°	1000 lm	3000 K	Nero	279602	50

DIMMABLE DRIVER* Optional

	Potenza	Output	Misura (LxHxP)	Codice	€
1-10V / Push	20 W	350 mA	108x22x52 mm	287867	75
DALI / Push	20 W	350 mA	120x29x51 mm	287874	80



Light beam: ACCENT

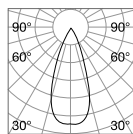

m	lx	Øm
1	1312	0,71
2	328	1,40
3	146	2,10
4	82	2,80
5	52	3,50



CRI≥90 9W 36° 750lm 3000K

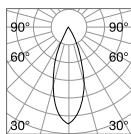

m	lx	Øm
1	1846	0,65
2	461	1,30
3	205	1,90
4	115	2,60
5	74	3,20



CRI≥90 13W 36° 1000lm 3000K

* Gli alimentatori dimmerabili devono essere ordinati contestualmente al prodotto e verranno già inclusi all'interno degli apparecchi in sostituzione degli alimentatori on-off.
** Lente 36° inclusa.

Bento - Frame and Reflector

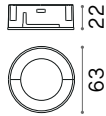

ROUND - REFLECTOR Necessario

Finitura	Codice	€
Bianco	279633	6
Nero	279640	6

0,020 Kg/0,0001 m³

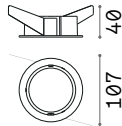

ROUND - FRAME SINGLE Necessario

Finitura	Codice	€
Bianco	287898	12
Nero	287881	12

Ⓜ 68 mm

0,060 Kg/0,0007 m³

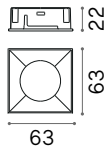

SQUARE - REFLECTOR Necessario

Finitura	Codice	€
Bianco	279671	8
Nero	279688	8

0,020 Kg/0,0001 m³

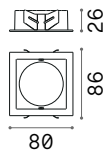

SQUARE - FRAME SINGLE Necessario

Finitura	Codice	€
Bianco	287911	14
Nero	287904	14

Ⓜ 68 x 68 mm

0,050 Kg/0,0002 m³

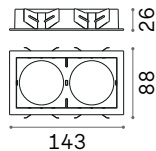

SQUARE - FRAME TWIN Necessario

Finitura	Codice	€
Bianco	287935	24
Nero	280233	24

Ⓜ 134 x 71 mm

0,110 Kg/0,0004 m³

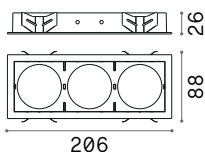

SQUARE - FRAME TRIPLE Necessario

Finitura	Codice	€
Bianco	287928	30
Nero	280240	30

Ⓜ 197 x 71 mm

0,300 Kg/0,0006 m³



Dynamic

Sistema componibile di elementi ad incasso in alluminio costituito da sorgente, riflettore e ghiera, con lenti e schermi in opzione; finitura bianca, nera; incasso possibile di forma rotonda o quadrata, tre diversi angoli di emissione a scelta. Sorgente luminosa con tecnologia COB LED integrato per la massima efficienza, disponibile con una temperatura di colore di 2700 K, 3000 K o 4000 K; LED ad efficienza energetica ad elevata resa cromatica; CRI ≥ 90 ; binning iniziale ≤ 3 -Step MacAdam; protezione frontale IP54 (a prodotto installato); classe isolamento II; durata utile LED 50.000 h L70B50. Disponibile in versione dimmerabile sia DALI che 1-10V. Per la sua dimensione compatta e grande versatilità è ottimale nelle installazioni di ambienti interni DOMESTICI, DIREZIONALI e RETAIL.

PRO

Prodotto ad alto contenuto tecnologico, elevata qualità dei materiali, destinato ad uso professionale.

UGR

Articolo con UGR <19.

IP54

Grado di protezione IP54.

Sorgente	LED COB
Potenza	9W / 10W / 15W
Driver incluso	On/Off
Driver disponibili	1-10V / DALI / Push
MacAdam	SDCM 3
CCT	2700 K / 3000 K / 4000 K
CRI	≥ 90
UGR	<19
Durata LED	50.000 h
Classe isolamento	II
IP	54
Materiale	Alluminio
Garanzia	5 anni





GU10 ADAPTOR WITH
LAMPHOLDER
INCLUDED - IP20

Necessario	Finitura	Codice	€
No	Bianco	208640	17
	Nero	208657	17



Light beam: ACCENT

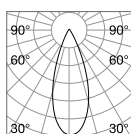

m	lx	Øm
1	1653	0,72
2	413	1,44
3	184	2,16
4	103	2,88
5	66	3,60



CRI≥90 9W 35° 9501m 3000K

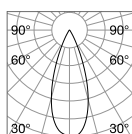

m	lx	Øm
1	1643	0,66
2	410	1,32
3	182	1,98
4	102	2,64
5	65	3,30



CRI≥90 10W 35° 10501m 3000K

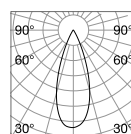

m	lx	Øm
1	2294	0,64
2	573	1,29
3	254	1,93
4	143	2,58
5	91	3,23



CRI≥90 15W 35° 15501m 3000K

Dynamic - Source

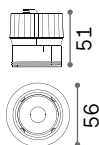

0,180 Kg/0,0030 m³

LED COB CITIZEN Necessario - Driver TRIDONIC ON/OFF incluso

Potenza	Angolo	Lumen	CCT	Finitura	Codice	€
9W	35°	930 lm	2700 K	Nero	252971	45
		950 lm	3000 K	Nero	252988	45
		1000 lm	4000 K	Nero	252995	45

DIMMABLE DRIVER* Optional

	Potenza	Output	Misura (LxHxP)	Codice	€
1-10V	12 W	200 mA	125x27x45 mm	253008	50
DALI/Push	9 W	200 mA	135x20x30 mm	253015	120

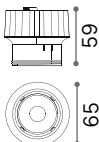

0,150 Kg/0,0030 m³

LED COB CITIZEN Necessario - Driver TRIDONIC ON/OFF incluso

Potenza	Angolo	Lumen	CCT	Finitura	Codice	€
10W	35°	1030 lm	2700 K	Nero	208541	65
		1050 lm	3000 K	Nero	208558	65
		1100 lm	4000 K	Nero	208565	65

DIMMABLE DRIVER* Optional

	Potenza	Output	Misura (LxHxP)	Codice	€
1-10V	10 W	250 mA	135x20x30 mm	216317	30
DALI/Push	17 W	250 mA	130x30x43 mm	216027	110

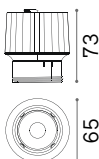

0,350 Kg/0,0030 m³

LED COB CITIZEN Necessario - Driver TRIDONIC ON/OFF incluso

Potenza	Angolo	Lumen	CCT	Finitura	Codice	€
15W	35°	1500 lm	2700 K	Nero	208572	90
		1550 lm	3000 K	Nero	208589	90
		1650 lm	4000 K	Nero	208596	90

DIMMABLE DRIVER* Optional

	Potenza	Output	Misura (LxHxP)	Codice	€
1-10V	20 W	350 mA	101x29x51 mm	216324	65
DALI/Push	17 W	350 mA	130x30x43 mm	216263	115

* Gli alimentatori dimmerabili devono essere ordinati contestualmente al prodotto e verranno già inclusi all'interno degli apparecchi in sostituzione degli alimentatori on-off. ** Lente 35° inclusa.

Dynamic Round

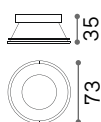
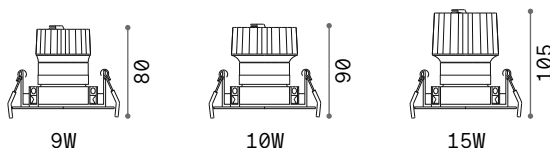

REFLECTOR Necessario

SIMMETRICO

0,020 Kg/0,0002 m³

Finitura	Codice	€
Bianco	211787	8
Nero	211794	8

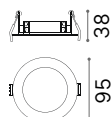

FRAME Necessario

① 80 mm

0,060 Kg/0,0004 m³

Finitura	Codice	€
Bianco	208695	17
Nero	208701	17



Dynamic Square

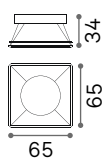
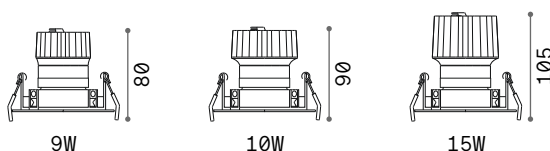

0,020 Kg/0,0002 m³

REFLECTOR Necessario

SIMMETRICO

Finitura	Codice	€
Bianco	211817	8
Nero	211824	8

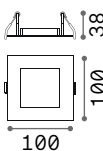

① 90 mm

0,050 Kg/0,0004 m³

FRAME Necessario

Finitura	Codice	€
Bianco	208725	19
Nero	208732	19

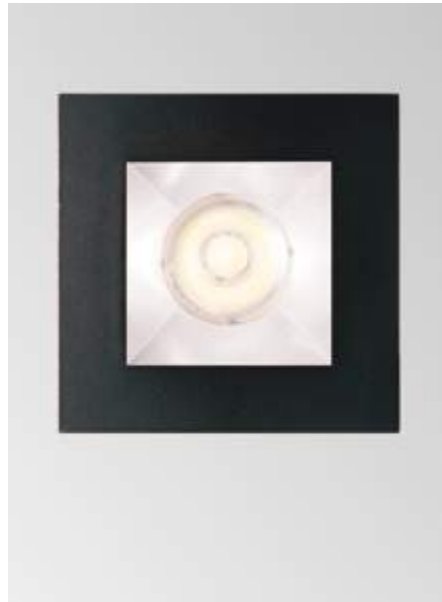

Game **new**

Faretto ad incasso in alluminio pressofuso con ghiera rotonda o quadrata, adatto per installazione su soffitti in cartongesso o a pannelli. Finitura argento opaca, bianca opaca RAL 9001, nera opaca RAL 9011, oro opaca RAL 1032. Disponibile in versione con cornice esterna (TRIM), a scomparsa senza cornice per cartongesso (TRIMLESS), oppure con cornice e protezione frontale migliorata (IP65). Tecnologia LED COB; disponibile in temperatura di colore 2700 K, 3000 K o 4000 K; Tecnologia LED SMD, CCT 2700 K, 3000 K o 4000 K; indice di resa cromatica CRI ≥ 90 , binning iniziale ≤ 3 Step MacAdam; protezione IP20; classe isolamento II; durata utile LED 50.000 h L70B50. Disponibile anche in versione dimmerabile 1-10V, DALI e PUSH. Per la sua dimensione compatta e grande versatilità è ottimale nelle installazioni di ambienti interni RESIDENZIALI, COMMERCIALI e RETAIL.

UGR Articolo con UGR <19.

Sorgente	LED COB
Potenza	5W / 11W / 20W
Driver incluso	On/Off
Driver disponibili	1-10V/Push / DALI/Push
CCT	2700 K / 3000 K / 4000 K
CRI	≥ 90
UGR	<19
Durata LED	50.000 h
Classe isolamento	II
IP	20 / 65
Materiale	Alluminio
Garanzia	5 anni

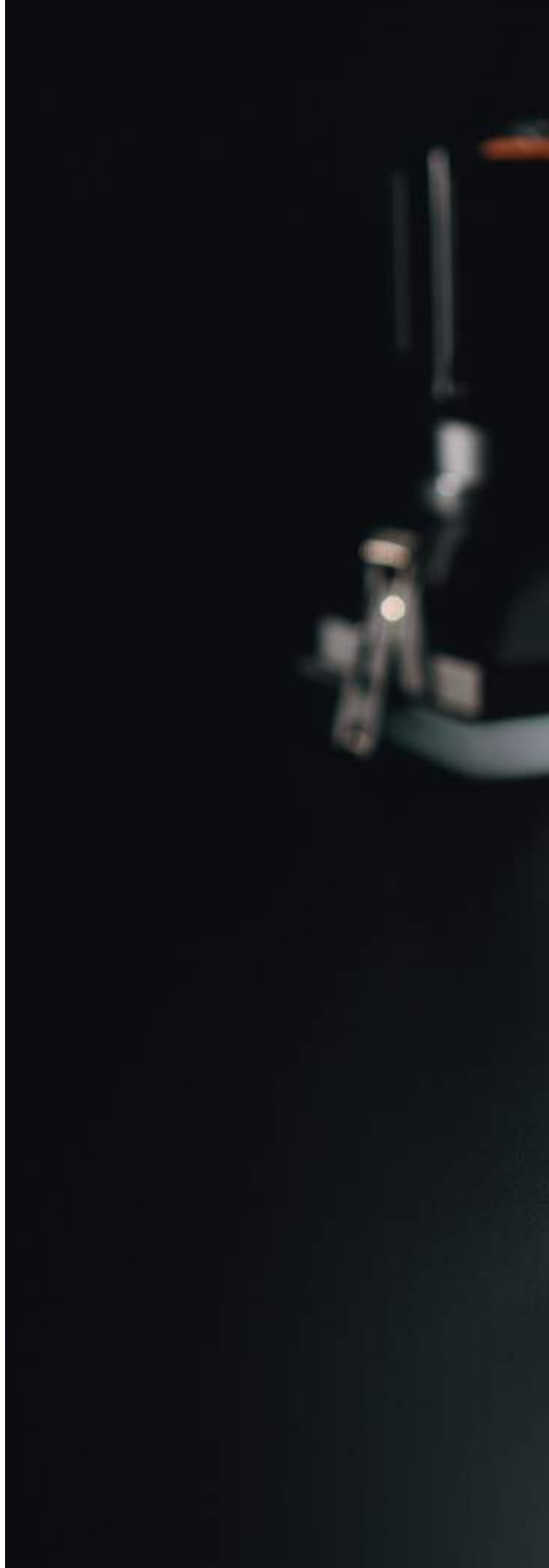



Game Trim Round

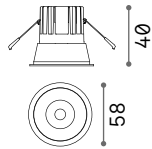

⌀ 50 mm
0,200 Kg/0,0009 m³

LED COB CREE Driver ON/OFF incluso

Potenza	Angolo	Lumen	CCT	Finitura	Codice	€
5 W	36°	650 lm	3000 K	Bianco	+ 337142	35 <i>new</i>
				Oro	+ 349084	35 <i>new</i>

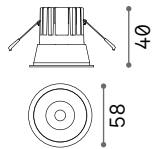

⌀ 50 mm
0,200 Kg/0,0009 m³

LED COB CREE Driver ON/OFF incluso

Potenza	Angolo	Lumen	CCT	Finitura	Codice	€
5 W	36°	650 lm	3000 K	Nero	+ 349060	35 <i>new</i>
				Oro	+ 349077	35 <i>new</i>



Light beam: ACCENT

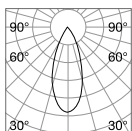

m	lx	Øm
1	1125	0,72
2	281	1,40
3	125	2,20
4	70	2,90
5	45	3,60



CRI≥90 5W 36° 650lm 3000K



Game Trim Round

LED COB CREE Driver ON/OFF incluso

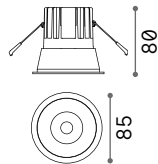

⌀ 75 mm
0,280 Kg/0,0011 m³

Potenza	Angolo	Lumen	CCT	Finitura	Codice	€
11W	36°	900 lm	2700 K	Bianco	285429	45
				Oro	341347	45 <small>new</small>
				Argento	192284	45
		950 lm	3000 K	Bianco	192291	45
				Nero	192277	45
				Oro	192307	45
1100 lm	4000 K	Bianco	267975	45		
		Oro	341361	45 <small>new</small>		

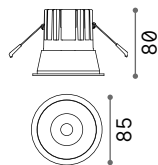

⌀ 75 mm
0,280 Kg/0,0011 m³

Potenza	Angolo	Lumen	CCT	Finitura	Codice	€
11W	36°	900 lm	2700 K	Nero	285412	45
				Oro	341330	45 <small>new</small>
				Argento	192321	45
		950 lm	3000 K	Bianco	192338	45
				Nero	192314	45
				Oro	192345	45
1100 lm	4000 K	Nero	267968	45		
		Oro	341354	45 <small>new</small>		

IP65

Potenza	Angolo	Lumen	CCT	Finitura	Codice	€
11W	36°	950 lm	3000 K	Bianco	313191	75
				Nero	327754	75

DIMMABLE DRIVER* Optional

	Potenza	Output	Misura (LxHxP)	Codice	€
1-10V/Push	20 W	250 mA	111x22x52 mm	217253	60
DALI/Push	12 W	250 mA	132x20x30 mm	202396	55



Light beam: ACCENT

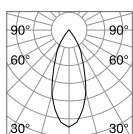

m	lx	Øm
1	1545	0,69
2	386	1,38
3	171	2,07
4	96	2,77
5	61	3,46



CRI≥90 11W 36° 950lm 3000K

* Gli alimentatori dimmerabili devono essere ordinati contestualmente al prodotto e verranno già inclusi all'interno degli apparecchi in sostituzione degli alimentatori on-off.



Game Trim Round

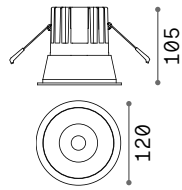

① 110 mm
0,660 Kg/0,0033 m³

LED COB BRIDGELUX

Potenza	Angolo	Lumen	CCT	Finitura	Codice	€
20W	24°	2100 lm	2700 K	Bianco	+ 341408	90 new
				Oro	+ 341392	90 new
		2250 lm	3000 K	Bianco	+ 273174	90
				Oro	+ 341422	90 new

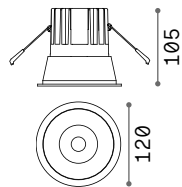

① 110 mm
0,660 Kg/0,0033 m³

LED COB BRIDGELUX Driver ON/OFF incluso

Potenza	Angolo	Lumen	CCT	Finitura	Codice	€
20W	24°	2100 lm	2700 K	Nero	+ 341378	90 new
				Oro	+ 341385	90 new
		2250 lm	3000 K	Nero	+ 273167	90
				Oro	+ 341415	90 new



Light beam: SPOT

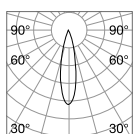

m	lx	Øm
1	8645	0,41
2	2161	0,83
3	961	1,20
4	540	1,70
5	346	2,10



CRI≥90 20W 24° 2250lm 3000K



Game Trim Square

LED COB CREE Driver ON/OFF incluso - CRI ≥90

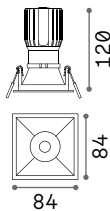

75 x 75 mm
0,310 Kg/0,0016 m³

Potenza	Angolo	Lumen	CCT	Finitura	Codice	€
11W	36°	900 lm	2700 K	Bianco +	285443	50
		950 lm	3000 K	Bianco +	192376	50
				Nero +	192352	50

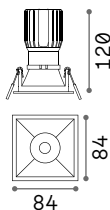

75 x 75 mm
0,310 Kg/0,0016 m³

Potenza	Angolo	Lumen	CCT	Finitura	Codice	€
11W	36°	900 lm	2700 K	Nero +	285436	50
		950 lm	3000 K	Bianco +	192406	50
				Nero +	192383	50

IP65

Potenza	Angolo	Lumen	CCT	Finitura	Codice	€
11W	36°	950 lm	3000 K	Bianco +	313207	75
				Nero +	327761	75

DIMMABLE DRIVER* Optional

	Potenza	Output	Misura (L x H x P)	Codice	€
1-10V/Push	20 W	250 mA	111 x 22 x 52 mm	217253	60
DALI/Push	12 W	250 mA	132 x 20 x 30 mm	202396	55



Light beam: ACCENT

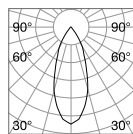

m	lx	Øm
1	1545	0,69
2	386	1,38
3	171	2,07
4	96	2,77
5	61	3,46



CRI≥90 11W 36° 950lm 3000K

* Gli alimentatori dimmerabili devono essere ordinati contestualmente al prodotto e verranno già inclusi all'interno degli apparecchi in sostituzione degli alimentatori on-off.



Game Trimless

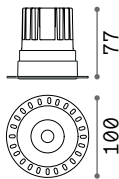

⌀ 75 mm

0,300 Kg/0,0011 m³

LED COB CREE Driver ON/OFF incluso - CRI ≥90

Potenza	Angolo	Lumen	CCT	Finitura	Codice	€
11W	36°	950 lm	3000 K	Bianco	319667	50
				Nero	319650	50

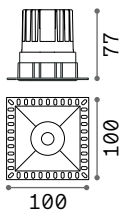

75 x 75 mm

0,300 Kg/0,0011 m³

LED COB CREE Driver ON/OFF incluso - CRI ≥90

Potenza	Angolo	Lumen	CCT	Finitura	Codice	€
11W	36°	950 lm	3000 K	Bianco	319681	50
				Nero	319674	50

DIMMABLE DRIVER* Optional

	Potenza	Output	Misura (LxHxP)	Codice	€
1-10V/Push	20 W	250 mA	111x22x52 mm	217253	60
DALI/Push	12 W	250 mA	132x20x30 mm	202396	55



Light beam: ACCENT

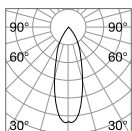

m	lx	Øm
1	1609	0,60
2	402	1,20
3	179	1,80
4	101	2,40
5	64	3,00



CRI≥80 11W 36° 950lm 3000K

* Gli alimentatori dimmerabili devono essere ordinati contestualmente al prodotto e verranno già inclusi all'interno degli apparecchi in sostituzione degli alimentatori on-off.



Tag new

Sorgente	LED SMD	Durata LED	50.000 h
Potenza	7W	Classe isolamento	II
Driver incluso	On/Off	IP	20
Driver disponibili	No	Materiale	Alluminio
CCT	2700 K / 3000 K / 4000 K	Garanzia	5 anni
CRI	≥90		



⌀ 75 mm

0,140 Kg/0,0009 m³

LED SMD Driver ON/OFF incluso*

Potenza	Angolo	Lumen	CCT	Finitura	Codice	€
7W	50°	810 lm	2700 K	Bianco	344850	15 <small>new</small>
				Nero	344843	15 <small>new</small>
		830 lm	3000 K	Bianco	331263	15 <small>new</small>
				Nero	331256	15 <small>new</small>
		840 lm	4000 K	Bianco	344874	15 <small>new</small>
				Nero	344867	15 <small>new</small>



Light beam: ACCENT

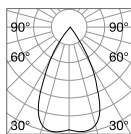

m	lx	Øm
1	838	0,98
2	209	2,00
3	93	2,90
4	52	3,90
5	34	4,90



CRI≥90 7W 50° 830lm 3000K



One

Sorgente	LED SMD	Durata LED	30.000 h
Potenza	2W / 3W	Classe isolamento	II
Driver incluso	On/Off	IP	20
Driver disponibili	No	Materiale	Alluminio
CCT	3000 K	Garanzia	5 anni
CRI	≥90		

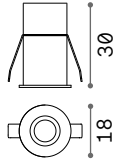

⌀ 17 mm

0,050 Kg/0,0001 m³

LED SMD Driver ON/OFF incluso (installazione remota)*

Potenza	Angolo	Lumen	CCT	Finitura	Codice	€
2W	23°	130 lm	3000 K	Bianco	274768	31

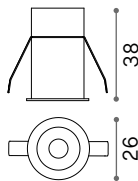

⌀ 25 mm

0,070 Kg/0,0001 m³

LED SMD Driver ON/OFF incluso (installazione remota)*

Potenza	Angolo	Lumen	CCT	Finitura	Codice	€
2W	30°	130 lm	3000 K	Bianco	274775	37

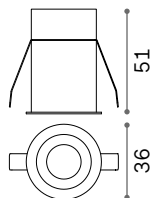

⌀ 35 mm

0,100 Kg/0,0003 m³

LED SMD Driver ON/OFF incluso (installazione remota)*

Potenza	Angolo	Lumen	CCT	Finitura	Codice	€
3W	23°	270 lm	3000 K	Bianco	274782	41

* Misure L 38,3 x H 16,5 x P 19,3 mm



Light beam: SPOT

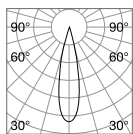

m	lx	Øm
1	372	0,40
2	93	0,81
3	41	1,20
4	23	1,60
5	15	2,00



CRI≥90 2W 23° 130lm 3000K



Light beam: SPOT

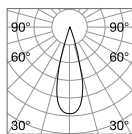

m	lx	Øm
1	307	0,53
2	77	1,10
3	34	1,60
4	19	2,10
5	12	2,70



CRI≥90 2W 30° 130lm 3000K



Light beam: SPOT

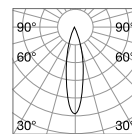

m	lx	Øm
1	866	0,40
2	216	0,80
3	96	1,20
4	54	1,60
5	35	2,00



CRI≥90 3W 23° 270lm 3000K



Virus

Sorgente	LED SMD	Durata LED	50.000 h
Potenza	3W	Classe isolamento	II
Driver incluso	On/Off	IP	20
Driver disponibili	No	Materiale	Alluminio
CCT	3000 K	Garanzia	5 anni
CRI	≥90		

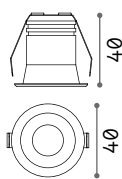

⌀ 30 mm
0,070 Kg/0,0003 m³

LED SMD OSRAM Driver ON/OFF incluso

Potenza	Angolo	Lumen	CCT	Finitura	Codice	€
3W	20°	210 lm	3000 K	Bianco	+ 244808	32
				Oro	+ 244822	32
				Nero	+ 244846	32
				Oro	+ 244853	32



Light beam: SPOT

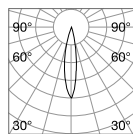

m	lx	Øm
1	1374	0,30
2	344	0,60
3	153	0,91
4	86	1,20
5	55	1,50



CRI≥90 3W 20° 210lm 3000K



244808



244822



244846



244853



Quark new

Sorgente	LED COB / SMD	Durata LED	30.000 h
Potenza	2,8W / 12W	Classe isolamento	II
Driver incluso	On/Off	IP	20
Driver disponibili	No	Materiale	Alluminio
CCT	3000 K	Garanzia	5 anni
CRI	≥90		

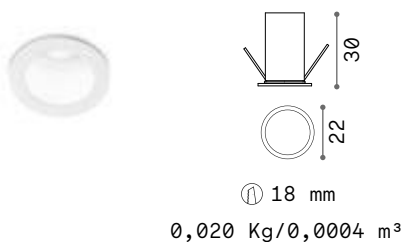

LED SMD BRIDGELUX Driver ON/OFF incluso

Potenza	Angolo	Lumen	CCT	Finitura	Codice	€
2,8W	30°	160 lm	3000 K	Bianco	327471	30
				Nero	305844	30

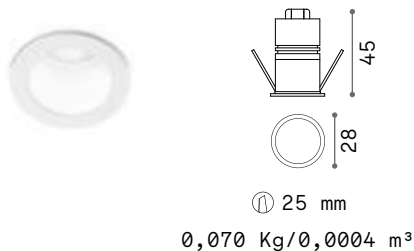

LED SMD BRIDGELUX Driver ON/OFF incluso

Potenza	Angolo	Lumen	CCT	Finitura	Codice	€
3W	25°	230 lm	3000 K	Bianco	327488	35
				Nero	305851	35

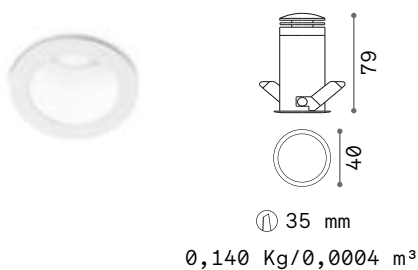

LED SMD BRIDGELUX Driver ON/OFF incluso

Potenza	Angolo	Lumen	CCT	Finitura	Codice	€
5W	30°	320 lm	3000 K	Bianco	307756	50
				Nero	327495	50



Light beam: SPOT

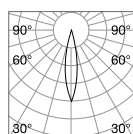

m	lx	Øm
1	1220	0,35
2	305	0,70
3	136	1,00
4	76	1,40
5	49	1,70



CRI≥90 8W 30° 320lm 3000K



Quark



⌀ 52 mm

0,210 Kg/0,0007 m³

LED COB Driver ON/OFF incluso

Potenza	Angolo	Lumen	CCT	Finitura	Codice	€
9W	25°	950 lm	3000 K	Bianco	344836	55 <i>new</i>
				Nero	322889	55 <i>new</i>

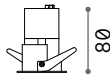

⌀ 45 mm

0,190 Kg/0,0007 m³

LED COB Driver ON/OFF incluso

Potenza	Angolo	Lumen	CCT	Finitura	Codice	€
9W	25°	950 lm	3000 K	Bianco	344829	60 <i>new</i>
				Nero	322971	60 <i>new</i>

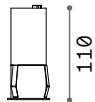

⌀ 45 mm

0,190 Kg/0,0009 m³

LED COB Driver ON/OFF incluso

Potenza	Angolo	Lumen	CCT	Finitura	Codice	€
12W	25°	1200 lm	3000 K	Bianco	344812	60 <i>new</i>
				Nero	322919	60 <i>new</i>

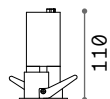

⌀ 52 mm

0,250 Kg/0,0009 m³

LED COB Driver ON/OFF incluso

Potenza	Angolo	Lumen	CCT	Finitura	Codice	€
12W	25°	1200 lm	3000 K	Bianco	344805	65 <i>new</i>
				Nero	323008	65 <i>new</i>



Light beam: SPOT



Light beam: SPOT

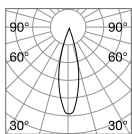

m	lx	Øm
1	2760	0,48
2	690	0,97
3	306	1,46
4	172	1,95
5	110	2,92



CRI≥90 9W 25° 950lm 3000K

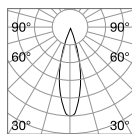

m	lx	Øm
1	3914	0,48
2	978	0,96
3	434	1,44
4	244	1,92
5	156	2,40



CRI≥90 12W 25° 1200lm 3000K



322889



322889



322971

763

Off

Incasso fisso in alluminio pressofuso con ghiera rotonda in tre dimensioni, adatto per installazione su soffitti in cartongesso. Finitura nera opaca RAL 9005 e bianca opaca RAL 9016, LED integrati raffreddati passivamente; tecnologia COB (Chip on Board) per la massima efficienza; UGR < 19; binning iniziale ≤ 3-Step MacAdam; disponibile in temperatura di colore 3000 K e 4000 K; CRI ≥ 90; protezione frontale IP54 (a prodotto installato); classe isolamento II; in opzione dimmerabile 1-10V, DALI e Push; durata utile LED 50.000 h L80B50. Adatto per UFFICI e ambienti DIREZIONALI e in generale dove vi sia la presenza di videotermini e la necessità di garantire un controllo dell'abbagliamento elevato. L'elevata resa cromatica lo rende ideale anche per gli spazi espositivi e la valorizzazione della merce in showroom e aree vendita nel settore RETAIL.

PRO Prodotto ad alto contenuto tecnologico, elevata qualità dei materiali, destinato ad uso professionale.

UGR Articolo con UGR <19.

IP54 Grado di protezione IP54.

Sorgente	LED COB
Potenza	15W / 28W / 42W
Driver incluso	On/Off
Driver disponibili	1-10V / DALI / Push
MacAdam	SDCM 3
CCT	3000 K / 4000 K
CRI	≥90
UGR	<19
Durata LED	50.000 h
Classe isolamento	II
IP	54
Materiale	Alluminio
Garanzia	5 anni





Off

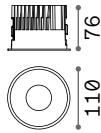

⌀ 100 mm

0,460 Kg/0,0021 m³

LED COB CITIZEN Driver TRIDONIC ON/OFF incluso

Potenza	Angolo	Lumen	CCT	Finitura	Codice	€
15 W	50°	1350 lm	3000 K	Bianco	266497	86
				Nero	266558	86
		1450 lm	4000 K	Bianco	266503	86
				Nero	266565	86

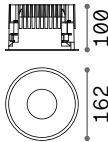

⌀ 150 mm

0,990 Kg/0,0045 m³

LED COB CITIZEN Driver TRIDONIC ON/OFF incluso

Potenza	Angolo	Lumen	CCT	Finitura	Codice	€
28 W	60°	2900 lm	3000 K	Bianco	266510	128
				Nero	266572	128
		3150 lm	4000 K	Bianco	266527	128
				Nero	266589	128

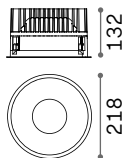

⌀ 205 mm

1,850 Kg/0,0094 m³

LED COB CITIZEN Driver TRIDONIC ON/OFF incluso

Potenza	Angolo	Lumen	CCT	Finitura	Codice	€
42 W	60°	4150 lm	3000 K	Bianco	266534	180
				Nero	266596	180
		4500 lm	4000 K	Bianco	266541	180
				Nero	266602	180

DIMMABLE DRIVER* Optional

Modello	Controllo	Potenza	Output	Misura (L x H x P)	Codice	€
Off 15 W	1-10V/Push	20 W	350 mA	105 x 20 x 50 mm	266657	70
	DALI	20 W	350 mA	120 x 29 x 51 mm	266701	70
Off 28 W	1-10V/Push	32 W	700 mA	100 x 20 x 65 mm	266671	95
	DALI	32 W	700 mA	108 x 30 x 44 mm	266725	95
Off 42 W	1-10V	42 W	1050 mA	120 x 20 x 75 mm	266688	115
	DALI/Push	45 W	1050 mA	150 x 30 x 43 mm	266732	110



Light beam: WIDE

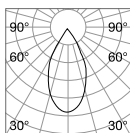

m	lx	øm
1	1688	0,93
2	422	1,90
3	188	2,80
4	105	3,70
5	68	4,60

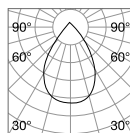
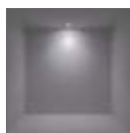

m	lx	øm
1	2457	1,30
2	614	2,50
3	273	3,80
4	154	5,10
5	98	6,40

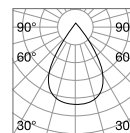
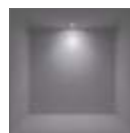

m	lx	øm
1	3496	1,20
2	874	2,40
3	388	3,60
4	218	4,80
5	140	6,00

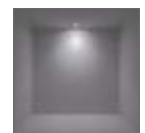

CRI≥90 15W 50° 1350lm 3000K

CRI≥90 28W 60° 2900lm 3000K

CRI≥90 42W 60° 4150lm 3000K

* Gli alimentatori dimmerabili devono essere ordinati contestualmente al prodotto e verranno già inclusi all'interno degli apparecchi in sostituzione degli alimentatori on-off.



Deep

Sorgente	LED SMD	Durata LED	50.000 h
Potenza	10W/20W/30W	Classe isolamento	II
Driver incluso	On/Off	IP	20
Driver disponibili	No	Materiale	Alluminio
CCT	3000 K/4000 K	Garanzia	5 anni
CRI	≥90		

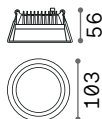

Ⓢ 90 mm

0,280 Kg/0,0015 m³

LED SMD Driver ON/OFF incluso

Potenza	Angolo	Lumen	CCT	Finitura	Codice	€
10W	70°	1300 lm	3000 K	Bianco	249018	35
		1400 lm	4000 K	Bianco	249025	35

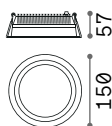

Ⓢ 145 mm

0,360 Kg/0,0037 m³

LED SMD Driver ON/OFF incluso

Potenza	Angolo	Lumen	CCT	Finitura	Codice	€
20W	77°	2650 lm	3000 K	Bianco	249032	70
		2850 lm	4000 K	Bianco	249049	70

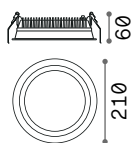

Ⓢ 210 mm

0,650 Kg/0,0053 m³

LED SMD Driver ON/OFF incluso

Potenza	Angolo	Lumen	CCT	Finitura	Codice	€
30W	77°	4000 lm	3000 K	Bianco	248783	90
		4150 lm	4000 K	Bianco	248790	90



Light beam: WIDE

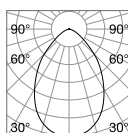

m	lx	cm
1	625	1,43
2	156	2,86
3	69	4,30
4	39	5,73
5	25	7,16

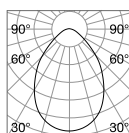
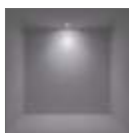

m	lx	cm
1	1056	1,60
2	264	3,20
3	117	4,81
4	66	6,41
5	42	8,01

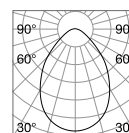
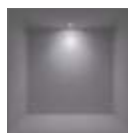

m	lx	cm
1	1644	1,60
2	411	3,20
3	183	4,81
4	103	6,41
5	66	8,01



CRI≥80 10W 70° 1300lm 3000K

CRI≥80 20W 77° 2650lm 3000K

CRI≥80 30W 77° 4000lm 3000K

* Gli alimentatori dimmerabili devono essere ordinati contestualmente al prodotto e verranno già inclusi all'interno degli apparecchi in sostituzione degli alimentatori on-off.



Basic

Faretto a incasso in alluminio pressofuso con ghiera rotonda, adatto per installazione su soffitti in cartongesso. Finitura bianca opaca; tecnologia COB Chip on Board e SMD. Disponibile in temperatura di colore 3000 K e con tre diverse ottiche; CRI ≥ 90 ; protezione frontale IP44 (a prodotto installato); classe isolamento II; durata utile LED 30.000 h L70B50.

IP44 Grado di protezione IP44.

Sorgente	LED COB / SMD
Potenza	10,5W / 15W / 20W
Driver incluso	On/Off
Driver disponibili	No
MacAdam	SDCM ≤ 3
CCT	3000 K
CRI	≥ 90
Durata LED	30.000 h
Classe isolamento	II
IP	20
Materiale	Alluminio
Garanzia	5 anni





Basic Accent

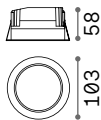

LED COB PHILIPS Driver PHILIPS ON/OFF incluso

Potenza	Angolo	Lumen	CCT	Finitura	Codice	€
10,5 W	45°	950 lm	3000 K	Bianco	193458	68

① 90 mm
0,400 Kg/0,0017 m³

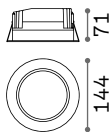

LED COB PHILIPS Driver PHILIPS ON/OFF incluso

Potenza	Angolo	Lumen	CCT	Finitura	Codice	€
15 W	52°	1400 lm	3000 K	Bianco	193465	85
20 W		2000 lm	3000 K	Bianco	193472	90

① 125 mm
0,660 Kg/0,0027 m³



Light beam: ACCENT

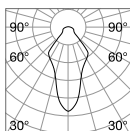

m	lx	Øm
1	533	0,81
2	133	1,62
3	59	2,44
4	33	3,25
5	21	4,07

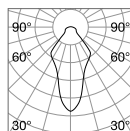

m	lx	Øm
1	719	0,98
2	179	1,96
3	79	2,95
4	44	3,93
5	28	4,92



CRI≥90 10,5W 45° 950lm 3000K

CRI≥90 15W 52° 1400lm 3000K

* Gli alimentatori dimmerabili devono essere ordinati contestualmente al prodotto e verranno già inclusi all'interno degli apparecchi in sostituzione degli alimentatori on-off.



Basic Wide

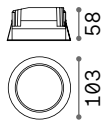

LED SMD SAMSUNG Driver PHILIPS ON/OFF incluso

Potenza	Angolo	Lumen	CCT	Finitura	Codice	€
10 W	85°	1100 lm	3000 K	Bianco	193519	65

① 90 mm
0,370 Kg/0,0017 m³

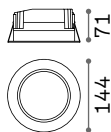

LED SMD SAMSUNG Driver PHILIPS ON/OFF incluso

Potenza	Angolo	Lumen	CCT	Finitura	Codice	€
15 W	87°	1650 lm	3000 K	Bianco	193526	80
20 W		2350 lm	3000 K	Bianco	193533	85

① 125 mm
0,630 Kg/0,0027 m³



Light beam: WIDE

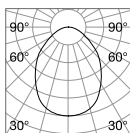

m	lx	cm
1	188	1,84
2	47	3,69
3	20	5,54
4	11	7,39
5	7	9,24

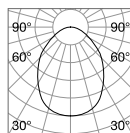
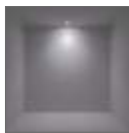

m	lx	cm
1	318	1,72
2	79	3,44
3	35	5,17
4	19	6,89
5	12	8,61

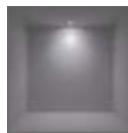

CRI≥90 10W 85° 1100lm 3000K

CRI≥90 15W 87° 1650lm 3000K

* Gli alimentatori dimmerabili devono essere ordinati contestualmente al prodotto e verranno già inclusi all'interno degli apparecchi in sostituzione degli alimentatori on-off.



Groove

IP20 CRI ≥80 30.000 h ALLUMINIO

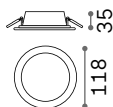

① 100 mm

0,220 Kg/0,0012 m³

LED SMD AND DRIVER Incluso

Potenza	Angolo	Lumen	CCT	Finitura	Codice	€
10 W	110°	1250 lm	3000 K	Bianco	123974	29
		1350 lm	4000 K	Bianco	147666	29

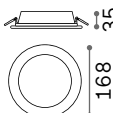

① 150 mm

0,410 Kg/0,0023 m³

LED SMD AND DRIVER Incluso

Potenza	Angolo	Lumen	CCT	Finitura	Codice	€
20 W	110°	2600 lm	3000 K	Bianco	123998	35
		2700 lm	4000 K	Bianco	147673	35

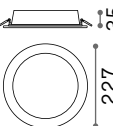

① 205 mm

0,660 Kg/0,0036 m³

LED SMD AND DRIVER Incluso

Potenza	Angolo	Lumen	CCT	Finitura	Codice	€
30 W	110°	3800 lm	3000 K	Bianco	124018	46
		4050 lm	4000 K	Bianco	147680	46

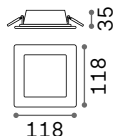

① 100 x 100 mm

0,270 Kg/0,0012 m³

LED SMD AND DRIVER Incluso

Potenza	Angolo	Lumen	CCT	Finitura	Codice	€
10 W	110°	1200 lm	3000 K	Bianco	123981	30

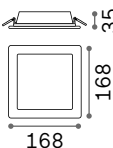

① 150 x 150 mm

0,540 Kg/0,0023 m³

LED SMD AND DRIVER Incluso

Potenza	Angolo	Lumen	CCT	Finitura	Codice	€
20 W	110°	2450 lm	3000 K	Bianco	124001	36

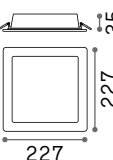

① 205 x 205 mm

0,850 Kg/0,0036 m³

LED SMD AND DRIVER Incluso

Potenza	Angolo	Lumen	CCT	Finitura	Codice	€
30 W	110°	3900 lm	3000 K	Bianco	124025	49



Light beam: WIDE

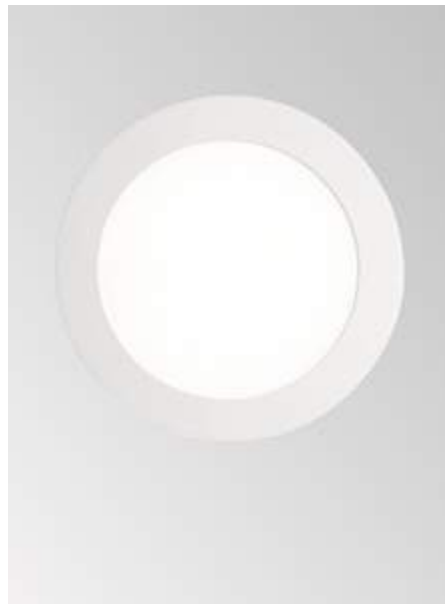

Play

Sorgente	LED COB	Durata LED	30.000 h
Potenza	7W	Classe isolamento	II
Driver incluso	On/Off	IP	20
Driver disponibili	No	Materiale	Alluminio
CCT	3000 K	Garanzia	5 anni
CRI	≥90		

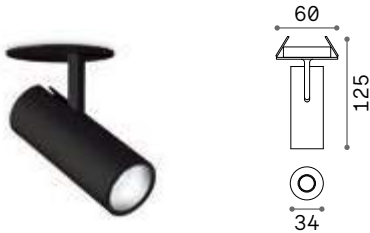

LED COB Driver ON/OFF incluso

Potenza	Angolo	Lumen	CCT	Finitura	Codice	€
7W	17°	520 lm	3000 K	Bianco	258270	60
				Nero	268088	60

90° 355° 45 mm

0,220 Kg/0,0014 m³



Light beam: SPOT

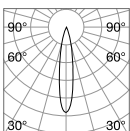

m	lx	Øm
1	2632	0,31
2	658	0,63
3	292	0,94
4	164	1,30
5	105	1,60



CRI≥90 7W 17° 520lm 3000K



P. 313



Nova new

Sorgente	LED COB	Durata LED	50.000 h
Potenza	12W / 30W	Classe isolamento	II
Driver incluso	On/Off	IP	20
Driver disponibili	1-10V / DALI / Push	Materiale	Alluminio
CCT	2700 K / 3000 K / 4000 K	Garanzia	5 anni
CRI	≥90		

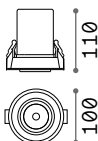

90° 360° 90 mm
 0,550 Kg/0,0016 m³

LED COB PHILIPS Driver ON/OFF incluso - UGR <19

Potenza	Angolo	Lumen	CCT	Finitura	Codice	€
12 W	38°	1100 lm	2700 K	Bianco	341859	78 <small>new</small>
				Nero	341842	78 <small>new</small>
		1200 lm	3000 K	Bianco	248165	78
				Nero	248189	78
		1300 lm	4000 K	Bianco	267937	78
				Nero	267920	78

DIMMABLE DRIVER* Optional

	Potenza	Output	Misura (L x H x P)	Codice	€
1-10V / Push	15 W	300 mA	111 x 22 x 52 mm	243993	60
DALI / Push	12 W	300 mA	132 x 20 x 30 mm	243986	55

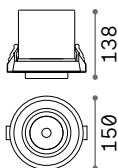

90° 360° 140 mm
 1,160 Kg/0,0039 m³

LED COB PHILIPS Driver ON/OFF incluso - UGR <22

Potenza	Angolo	Lumen	CCT	Finitura	Codice	€
30 W	38°	3000 lm	2700 K	Bianco	341873	125 <small>new</small>
				Nero	341866	125 <small>new</small>
		3150 lm	3000 K	Bianco	248172	125
				Nero	248196	125
		3300 lm	4000 K	Bianco	267951	125
				Nero	267944	125

DIMMABLE DRIVER* Optional

	Potenza	Output	Misura (L x H x P)	Codice	€
1-10V / Push	36 W	700 mA	167 x 32 x 41 mm	248370	100
DALI / Push	36 W	700 mA	135 x 24 x 72 mm	248592	100



Light beam: ACCENT



LENS

Modello	Necessario	Angolo	Codice	€
Nova 12W	No	15°	244013	8
Nova 30W	No	15°	248608	12

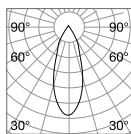

m	lx	cm
1	1768	0,66
2	442	1,32
3	196	1,97
4	111	2,63
5	71	3,29

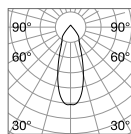

m	lx	cm
1	4671	0,64
2	1168	1,28
3	519	1,93
4	292	2,57
5	187	3,21



CRI≥90 12W 38° 1200lm 3000K

CRI≥90 30W 38° 3150lm 3000K

* Gli alimentatori dimmerabili devono essere ordinati contestualmente al prodotto e verranno già inclusi all'interno degli apparecchi in sostituzione degli alimentatori on-off.



Led Panel

Sorgente	LED SMD	UGR	<19
Potenza	40W	Durata LED	25.000 h
Driver incluso	On/Off	Classe isolamento	II
Driver disponibili	1-10V / DALI / Push	IP	20
CCT	3000 K / 4000 K	Materiale	Alluminio
CRI	≥80 / ≥90	Garanzia	5 anni

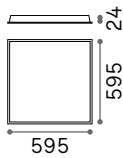

2,200 Kg/0,0144 m³
Q.tà d'acquisto 2 pezzi

LED SMD Driver ON/OFF incluso

CRI ≥80

Potenza	Angolo	Lumen	CCT	Finitura	Codice	€
40 W	81°	5500 lm	3000 K	Bianco	249711	35
		6150 lm	4000 K	Bianco	249728	35

CRI ≥90

Potenza	Angolo	Lumen	CCT	Finitura	Codice	€
40 W	81°	5100 lm	3000 K	Bianco	246390	35
		5450 lm	4000 K	Bianco	244181	35

DIMMABLE DRIVER* Optional

	Potenza	Output	Misura (L x H x P)	Codice	€
1-10V	42 W	1000 mA	125 x 26 x 83 mm	247854	29
DALI/Push	45 W	1000 mA	106 x 28 x 69 mm	247847	72



KIT PENDANT

KIT SURFACE

RECESSED FRAME**

Necessario	N° Cavi	Lunghezza cavi	Codice	€
No	4	1000 mm	244198	10
No			244204	10
No			267692	20



Light beam: WIDE

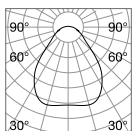

m	lx	Øm
1	1470	1,79
2	367	3,59
3	163	5,38
4	92	7,18
5	59	8,97

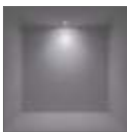

CRI≥80 40W 81° 5500lm 3000K

* Gli alimentatori dimmerabili devono essere ordinati contestualmente al prodotto e verranno già inclusi all'interno degli apparecchi in sostituzione degli alimentatori on-off.

**RECESSED FRAME 607 x 607 mm



Lika **new**

Proiettore ad incasso rettangolare in alluminio pressofuso verniciato, con sorgenti luminose arretrate, disponibile nelle versioni TRIM con bordo e TRIMLESS senza bordo, con riflettore in policarbonato nero lucido, e SLIM con dimensioni ridotte. Tecnologia LED SMD; CCT 2700 K, 3000 K o 4000 K; CRI \geq 90, SDCM \leq 3; durata utile LED 50.000 h L70B50.

UGR Articolo con UGR <16.

Sorgente	LED COB / SMD
Potenza	5,5W / 12W / 20W
Driver incluso	On/Off
Driver disponibili	DALI / Push
CCT	2700 K / 3000 K / 4000 K
CRI	\geq 90
UGR	<16
Durata LED	50.000 h
Classe isolamento	II
IP	20
Materiale	Alluminio
Garanzia	5 anni





Lika Trim

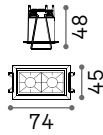

68 x 37 mm
0,180 Kg/0,0009 m³

LED SMD OSRAM Driver ON/OFF incluso

Potenza	Angolo	Lumen	CCT	Finitura	Codice	€
5,5W	29°	340 lm	2700 K	Nero	+ 341729	45 new
		350 lm	3000 K	Nero	+ 206196	45
		400 lm	4000 K	Nero	+ 267869	45

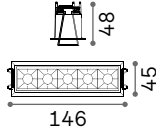

140 x 37 mm
0,320 Kg/0,0013 m³

LED SMD OSRAM Driver ON/OFF incluso

Potenza	Angolo	Lumen	CCT	Finitura	Codice	€
12W	29°	850 lm	2700 K	Nero	+ 341736	70 new
		880 lm	3000 K	Nero	+ 206219	70
		1000 lm	4000 K	Nero	+ 267876	70

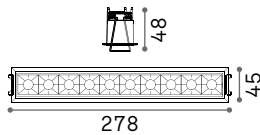

273 x 37 mm
0,580 Kg/0,0022 m³

LED SMD OSRAM Driver ON/OFF incluso

Potenza	Angolo	Lumen	CCT	Finitura	Codice	€
20W	29°	1700 lm	2700 K	Nero	+ 341743	110 new
		1750 lm	3000 K	Nero	+ 206233	110
		2000 lm	4000 K	Nero	+ 267883	110

DIMMABLE DRIVER* Optional

Modello	Controllo	Potenza	Output	Misura (LxHxP)	Codice	€
5.5W/12W	DALI	12 W	700 mA	132x20x30 mm	267982	56
20 W	DALI/Push	25 W	600 mA	135x24x72 mm	268002	75



Light beam: ACCENT

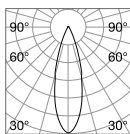

m	lx	Øm
1	2091	0,58
2	523	1,16
3	232	1,74
4	131	2,32
5	70	2,90



CRI≥90 12W 29° 880lm 3000K

* Gli alimentatori dimmerabili devono essere ordinati contestualmente al prodotto e verranno già inclusi all'interno degli apparecchi in sostituzione degli alimentatori on-off.



Lika Trimless

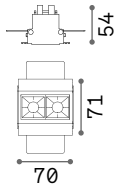

75 x 70 mm
0,220 Kg/0,0006 m³

LED SMD OSRAM Driver ON/OFF incluso

Potenza	Angolo	Lumen	CCT	Finitura	Codice	€
5,5W	29°	340 lm	2700 K	Nero	341750	60 new
		350 lm	3000 K	Nero	206202	60
		400 lm	4000 K	Nero	267890	60

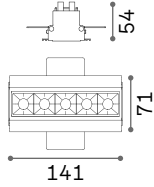

145 x 70 mm
0,450 Kg/0,0013 m³

LED SMD OSRAM Driver ON/OFF incluso

Potenza	Angolo	Lumen	CCT	Finitura	Codice	€
12W	29°	850 lm	2700 K	Nero	341767	95 new
		880 lm	3000 K	Nero	206226	95
		1000 lm	4000 K	Nero	267906	95

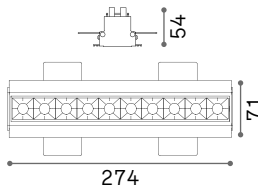

278 x 70 mm
0,720 Kg/0,0023 m³

LED SMD OSRAM Driver ON/OFF incluso

Potenza	Angolo	Lumen	CCT	Finitura	Codice	€
20W	29°	1700 lm	2700 K	Nero	341774	150 new
		1750 lm	3000 K	Nero	206240	150
		2000 lm	4000 K	Nero	267913	150

DIMMABLE DRIVER* Optional

Modello	Controllo	Potenza	Output	Misura (LxHxP)	Codice	€
5,5W/12W	DALI	10 W	700 mA	132x20x30 mm	267982	56
20 W	DALI/Push	25 W	600 mA	135x24x72 mm	268002	75



Light beam: ACCENT

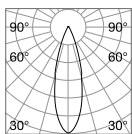

m	lx	Øm
1	2786	0,58
2	696	1,16
3	309	1,74
4	174	2,32
5	111	2,90



CRI≥90 12W 29° 880lm 3000K

* Gli alimentatori dimmerabili devono essere ordinati contestualmente al prodotto e verranno già inclusi all'interno degli apparecchi in sostituzione degli alimentatori on-off.



Lika Slim

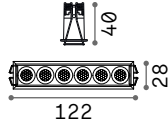

117 x 23 mm
0,180 Kg/0,0013 m³

LED SMD Driver ON/OFF incluso

Potenza	Angolo	Lumen	CCT	Finitura	Codice	€
10 W	32°	900 lm	2700 K	Nero	341644	66 <small>new</small>
		1000 lm	3000 K	Bianco	327501	66
		1200 lm	4000 K	Nero	305813	66
				Bianco	341675	66 <small>new</small>
				Nero	341668	66 <small>new</small>

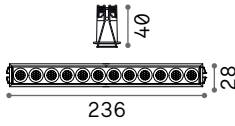

231 x 23 mm
0,300 Kg/0,0022 m³

LED SMD Driver ON/OFF incluso

Potenza	Angolo	Lumen	CCT	Finitura	Codice	€
20 W	32°	1800 lm	2700 K	Nero	341682	110 <small>new</small>
		2000 lm	3000 K	Bianco	327518	110
		2400 lm	4000 K	Nero	305837	110
				Bianco	341712	110 <small>new</small>
				Nero	341705	110 <small>new</small>



Light beam: ACCENT

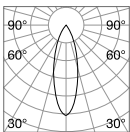

m	lx	Øm
1	1958	0,55
2	489	1,10
3	218	1,70
4	122	2,20
5	78	2,80



CRI≥90 10W 32° 1000lm 3000K



Samba

IP20 GESSO

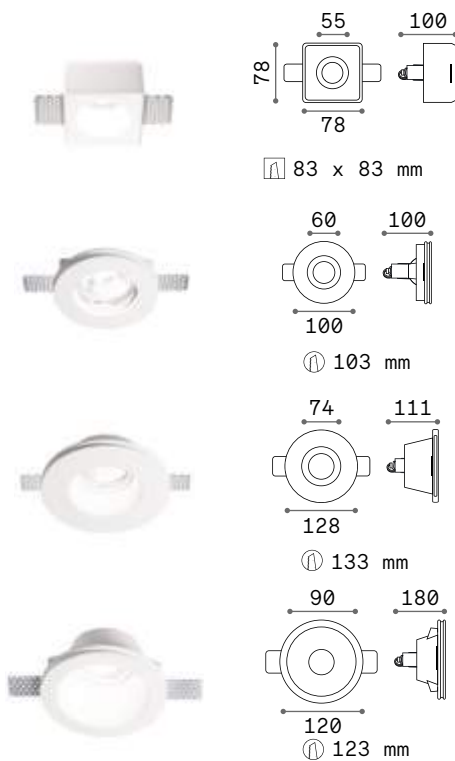

GU10 Non inclusa - Lampadina consigliata 108292

Potenza	Peso	Volume	Finitura	Codice	€
max 35W	0,360 Kg	0,0016 m ³	Bianco	230580	10

Potenza	Peso	Volume	Finitura	Codice	€
max 35W	0,240 Kg	0,0018 m ³	Bianco	150307	10

Potenza	Peso	Volume	Finitura	Codice	€
max 35W	0,450 Kg	0,0032 m ³	Bianco	150130	12

Potenza	Peso	Volume	Finitura	Codice	€
max 50W	0,420 Kg	0,0036 m ³	Bianco	139012	12

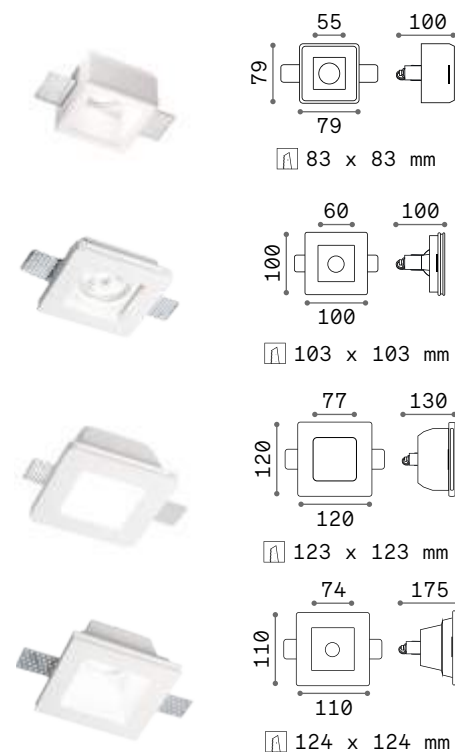

GU10 Non inclusa - Lampadina consigliata 108292

Potenza	Peso	Volume	Finitura	Codice	€
max 35W	0,330 Kg	0,0016 m ³	Bianco	229997	10

Potenza	Peso	Volume	Finitura	Codice	€
max 35W	0,330 Kg	0,0019 m ³	Bianco	150291	10

Potenza	Peso	Volume	Finitura	Codice	€
max 35W	0,600 Kg	0,0037 m ³	Bianco	150116	12

Diffusore in vetro

Potenza	Peso	Volume	Finitura	Codice	€
max 50W	0,430 Kg	0,0023 m ³	Bianco	139029	12



Jazz

IP20 ZINCO

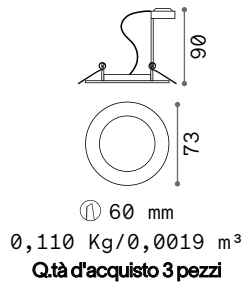

GU10 Non inclusa - Lampadina consigliata 108292

Potenza	Finitura	Codice	€
max 50W	Bianco	083117	11
	Brunito	083124	11
	Cromo	083070	11
	Nero	243818	11
	Nickel	083087	11

Swing

IP20 ZINCO

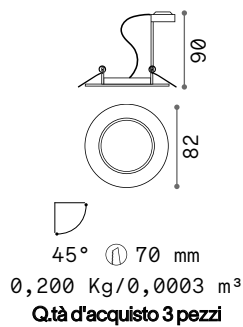

GU10 Non inclusa - Lampadina consigliata 108292

Potenza	Finitura	Codice	€
max 28W	Bianco	083179	13
	Brunito	083186	13
	Cromo	083131	13
	Nero	243825	13
	Nickel	083148	13

Lounge

IP20 ZINCO

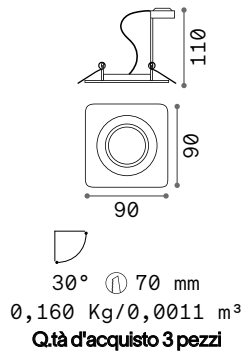

GU10 Non inclusa - Lampadina consigliata 108292

Potenza	Finitura	Codice	€
max 50W	Bianco	138978	17

Funky

IP20 FERRO

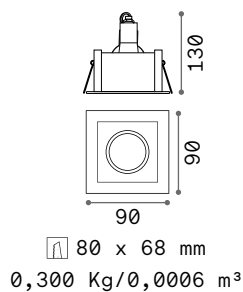

GU10 Non inclusa - Lampadina consigliata 108292

Potenza	Finitura	Codice	€
max 50W	Alluminio	083223	20
	Bianco	083230	20
	Brunito	083247	20
	Cromo	083193	20
	Nero	243849	20



Room-65

IP65 CRI ≥90 50.000 h ALLUMINIO

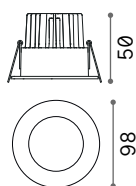

① 68 mm

0,220 Kg/0,0011 m³

LED COB Driver ON/OFF incluso

Potenza	Angolo	Lumen	CCT	Finitura	Codice	€
7,5 W	38°	750 lm	3000 K	Bianco	252025	77
				Nero	252032	77

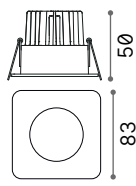

① 68 mm

0,240 Kg/0,0011 m³

LED COB Driver ON/OFF incluso

Potenza	Angolo	Lumen	CCT	Finitura	Codice	€
7,5 W	38°	750 lm	3000 K	Bianco	252049	77
				Nero	252056	77



Light beam: ACCENT



Blues

 IP20 VETRO

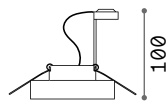

Ⓢ 60 mm

0,281 Kg/0,0031 m³

Q.tà d'acquisto 3 pezzi

GU10 Non inclusa - Lampadina consigliata 108292

Potenza	Finitura	Codice	€
max 50W	Trasparente	083254	25
	Bianco	113999	25
	Fumè	113982	25

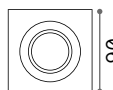
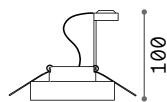

Ⓢ 60 mm

0,340 Kg/0,0012 m³

Q.tà d'acquisto 3 pezzi

GU10 Non inclusa - Lampadina consigliata 108292

Potenza	Finitura	Codice	€
max 50W	Trasparente	114019	25



Polka

□ ▲ IP20

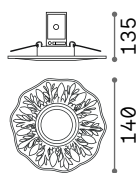

① 65 mm

0,250 Kg/0,0022 m³

GU10 Non inclusa - Lampadina consigliata 108292

Potenza	Materiale	Finitura	Codice	€
max 50W	Gesso	Bianco	115597	20
	Alluminio	Ottone	115610	20
	Alluminio	Brunito	115580	20



115597





115610



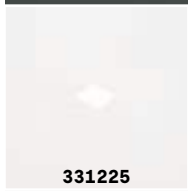

115580

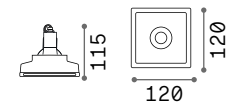

Zephyr new

 IP20
  GESSO



 123 x 123 mm
 0,880 Kg/0,0032 m³

GU10 Non inclusa - Lampadina consigliata 108292

Potenza	Finitura	Codice	€
max.35W	Bianco	150284	15

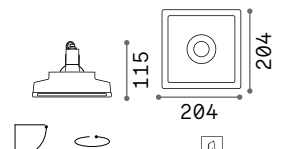

 207 x 207 mm
 1,350 Kg/0,0075 m³

GU10 Non inclusa - Lampadina consigliata 108292

Potenza	Finitura	Codice	€
max.35W	Bianco	155722	50

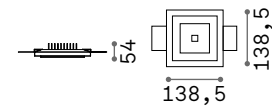

 141 x 141 mm
 0,920 Kg/0,0036 m³

LED COB CREE Driver ON/OFF incluso

CRI ≥90 50.000 h

Potenza	Lumen	CCT	Finitura	Codice	€
12 W	1200 lm	3000 K	Bianco	331225	75 new



Walky

IP20
 CRI ≥ 90
 50.000 h GESSO

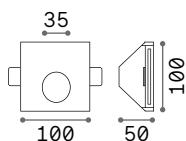

100 x 100mm
 0,580 Kg/0,0009 m³

LED SMD AND DRIVER Incluso

Potenza	Lumen	CCT	Finitura	Codice	€
1W	55 lm	3000 K	Bianco	249834	63

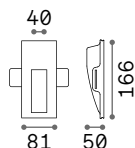

81 x 166 mm
 0,580 Kg/0,0012 m³

LED SMD AND DRIVER Incluso

Potenza	Lumen	CCT	Finitura	Codice	€
1W	55 lm	3000 K	Bianco	249827	63



Light beam: **ASYMMETRICAL**



Sospensioni e soffitto

Esterni

Indice alfabetico

Bubble	812
Clio	806
Fiesta	813
Gun	810
Luna	804
Mib	812
Snow	805
Sole	802
Techo	808
Urano	811

Indice icone

<small>new</small> 		<small>new</small> 
Sole 802	Luna 804	Snow 805
		
Clio 806	Clio 806	Clio 806
		
Clio 806	Clio 806	Clio 806
<small>new</small> 		
Techo 808	Gun 810	Urano 811
		
Bubble 812	Mib 812	Fiesta 813



Sole

Diffusore in materiale plastico opale. Base sospensione in alluminio. Cavo elettrico in PVC.

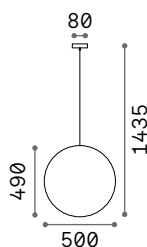

2,970 Kg / 0,1327 m³
E27 max 1x 42W

€ 180

136011 Bianco



4000 K
1020 lm

151991 € 2,00

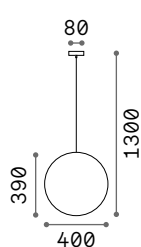

1,690 Kg / 0,0776 m³
E27 max 1x 42W

€ 110

136004 Bianco



4000 K
1020 lm

151991 € 2,00

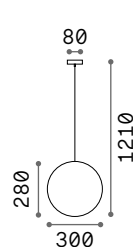

1,360 Kg / 0,0338 m³
E27 max 1x 42W

€ 95

135991 Bianco



4000 K
1020 lm

151991 € 2,00

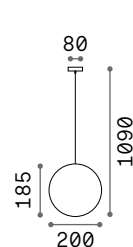

1,300 Kg / 0,0111 m³
E27 max 1x 42W

€ 90

318837 Bianco



4000 K
580 lm

151960 € 2,00



P. 877



Luna

Montatura in alluminio pressofuso e tornito rifinito con vernici a polveri. Diffusore in materiale plastico opale.



Lampadine LED G9 3W 4000 K incluse nel modello **213200**. Cod. **209036**

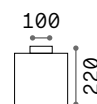

1,470 Kg / 0,0120 m³
E27 max 1x 42W

€ 115

213194 Bianco

4000 K
1000 lm

151991 € 2,00



0,400 Kg / 0,0021 m³
G9 max 1x 5W

€ 100

213200 Bianco

4000 K
530 lm

307879 € 6,00



P. 878



Snow new

Base e diffusore in policarbonato bianco. Fissaggio a incastro, senza viti a vista. Colore: bianco.

LED Sorgente luminosa LED 3000 K / 4000 K, 50.000 h di durata.

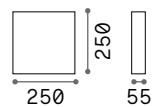

0,790 Kg / 0,0066 m³
LED 18W / 1900/2350 lm

€ 60

326238 Bianco 3000K^{new}
326245 Bianco 4000K^{new}



P. 855

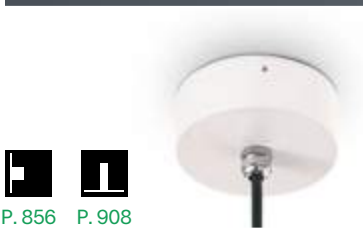

P. 856



P. 908

Clio

Articolo componibile con montatura in alluminio estruso e tornito, rifinito con vernici a polveri di colore antracite, bianco, grigio, nero e coffee. Diffusore in materiale plastico bianco opaco.



116716



145068



145020



144252



144238



136073



144245



326801



IP44

0,200 Kg / 0,0014 m³
E27 max 1x 42W

€ 56

148847 Bianco
148854 Grigio
148861 Antracite
148878 Nero
326795 Coffee

4000 K
580 lm
151960 € 2,00

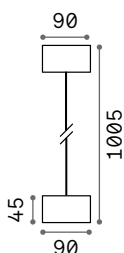

IP44

0,580 Kg / 0,0019 m³
E27 max 1x 42W

€ 75

144252 Bianco
144238 Grigio
136073 Antracite
144245 Nero
326801 Coffee

4000 K
580 lm
151960 € 2,00

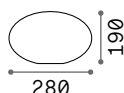

0,540 Kg / 0,0171 m³

€ 40

145068 Bianco

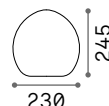

0,520 Kg / 0,0144 m³

€ 40

116716 Bianco

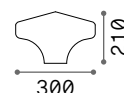

0,610 Kg / 0,0231 m³

€ 40

145020 Bianco



Techo new

Corpo luce in alluminio pressofuso verniciato a polveri. Diffusore in vetro temperato trasparente smerigliato. Colori: antracite, bianco, coffee o nero.

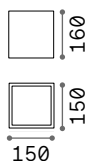

1,700 Kg / 0,0049 m³
GU10 max 1x20W

€ 115

- 251523 ■ Bianco
- 326887 ■ Grigio
- 251516 ■ Antracite
- 251530 ■ Nero
- 251547 ■ Coffee

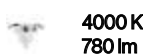

253398 € 15,00

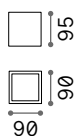

0,600 Kg / 0,0012 m³
GU10 max 1x20W

€ 64

- 251561 ■ Bianco
- 326894 ■ Grigio
- 251554 ■ Antracite
- 251578 ■ Nero
- 251592 ■ Coffee

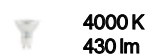

253497 € 3,00

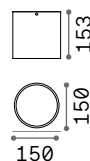

1,500 Kg / 0,0052 m³
GU10 max 1x20W

€ 115

- 342689 ■ Bianco new
- 342702 ■ Grigio new
- 318103 ■ Antracite new
- 342719 ■ Nero new
- 342696 ■ Coffee new

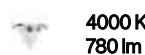

253398 € 15,00

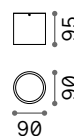

0,550 Kg / 0,0015 m³
GU10 max 1x20W

€ 64

- 318127 ■ Bianco new
- 342726 ■ Grigio new
- 318110 ■ Antracite new
- 318141 ■ Nero new
- 318134 ■ Coffee new

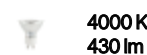

253497 € 3,00



Gun

Corpo luce in alluminio con finitura naturale spazzolata o in vernice con varie finiture. Diffusore in vetro pirex trasparente.



122663 092324 163642 236865 122687 163666

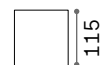

0,490 Kg / 0,0030 m³
GU10 max 1x28W

€ 54

122663 Bianco
092324 Alluminio
163642 Grigio
236865 Antracite
122687 Nero
163666 Coffee

4000 K
430 lm

253497 € 3,00



P. 834



Urano

Corpo luce in alluminio tornito verniciato a polveri con finitura opaca antracite o bianca. Diffusore in materiale acrilico trasparente e satinato.



168050



168135

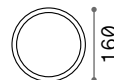
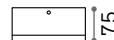

1,200 Kg / 0,0029 m³
GX53 max 1x15W

€ 95

168050 ■ Bianco
168135 ■ Antracite

4000 K
1000 lm

154008 € 5,00

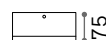

0,630 Kg / 0,0016 m³
GX53 max 1x15W

€ 70

168036 ■ Bianco
168111 ■ Antracite

4000 K
1000 lm

154008 € 5,00

Bubble

Montatura in alluminio pressofuso e tornito rifinito con vernici a polveri. Diffusore in materiale plastico bianco opaco.



1,730 Kg / 0,0249 m³

E27 max 1x 60W

€ 125

135250 Bianco

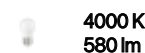

151960 € 2,00 P. 854



Mib

Base in alluminio verniciato a polveri di colore bianco. Diffusore in materiale plastico opale. Sorgente luminosa a led integrati.

LED Sorgente luminosa LED 3000/4000 K, 35.000 h di durata.

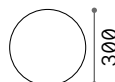

1,620 Kg / 0,0086 m³

LED 18W / 1850/2150 lm

€ 150

269115 Bianco 3000K
202945 Bianco 4000K

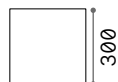

1,820 Kg / 0,0086 m³

LED 18W / 1950/2250 lm

€ 150

269122 Bianco 3000K
202921 Bianco 4000K





Fiesta

Cavo con portalampane e occhielli di ancoraggio in materiale plastico nero. Fornito con spina per esterni.

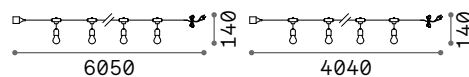

1,530 Kg / 0,0068 m³
E27 max 10 x 15W

€ 100

246796 ■ Nero

3000 K
340 lm

101286 € 2,00



0,600 Kg / 0,0049 m³
E27 max 5 x 15W

€ 65

159836 ■ Nero

3000 K
340 lm

101286 € 2,00



Lampade da parete

Esterni



Indice alfabetico

Andromeda	847	Rex-3	851
Apollo	832	Rubik	842
Argo	845	Sirio	841
Atom	843	Snif Round	830
Base	833	Snif Square	831
Bubble	854	Snow	855
Cima	857	Style	826
Clio	856	Swipe	825
Cometa	852	Terra	822
Dafne	857	Tetris-1	844
Dedra	859	Tetris-2	845
Down	858	Toffee	837
Elio	820	Tronco	828
Etere	829	Twin	846
Febe	858	Up	844
Felix	849	Xeno	824
Gas	823		
Giove	848		
Gun	834		
Iko	840		
Keope	832		
Linea	838		
Litio	821		
Medea	853		
Omega R.	819		
Omega S.	819		
O-Zone	818		
Polar	853		
Punto	836		
Rex-1	850		
Rex-2	851		



O-zone

Pag 818

new



O-zone 818



Omega R. 819



Style 826



Tronco 828

new



Punto 836



Toffee 837



Tetris-2 845



Argo 845



Cometa 852



Polar 853







































Dafne 857



Down 858

Esterni

Indice icone

						
Omega S. 819	Elio 820	Litio 821	Terra 822	Gas 823	Xeno 824	Swipe 825
						
Etere 829	SnifRound 830	SnifSquare 831	Keope 832	Apollo 832	Base 833	Gun 834
	<small>new</small> 					
Linea 838	Iko 840	Sirio 841	Rubik 842	Atom 843	Up 844	Tetris-1 844
						
Twin 846	Andromeda 847	Giove 848	Felix 849	Rex-1 850	Rex-2 851	Rex-3 851
		<small>new</small> 				
Medea 853	Bubble 854	Snow 855	Clio 856	Clio 856	Clio 856	Cima 857
						
Febe 858	Dedra 859					



O-zone new

Corpo luce in alluminio pressofuso verniciato a polveri. Diffusore orientabile con vetro temperato trasparente. Colori: nero.

LED

Sorgente luminosa LED 3000 K, 50.000 h di durata.

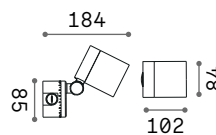

■ ■  IP66

0,800 Kg / 0,0060 m³
LED 13W / 1150 lm

€ 135

337548 ■ Nero new



P. 916

Omega Round

Corpo luce in alluminio verniciato a polveri. Diffusore inclinabile con schermo in vetro. Disponibile nelle finiture antracite, bianco, coffee o nero.

LED Sorgente luminosa LED 3000/4000 K, 25.000 h di durata.

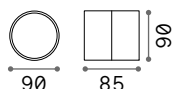

IP54

0,500 Kg / 0,0012 m³
LED 7W / 560/610 lm

€ 100

285474	Bianco	3000K
285481	Bianco	4000K
285450	Antracite	3000K
285467	Antracite	4000K
285504	Nero	4000K
285498	Coffee	4000K



Omega Square

Corpo luce in alluminio verniciato a polveri. Diffusore inclinabile con schermo in vetro. Disponibile nelle finiture antracite, bianco o nero.

LED Sorgente luminosa LED 4000 K, 25.000 h di durata.

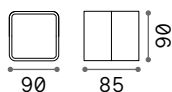

IP54

0,600 Kg / 0,0012 m³
LED 7W / 610 lm

€ 100

285528	Bianco
285511	Antracite
285535	Nero





Elio

Corpo luce e diffusore in resina ad alte prestazioni: inattaccabile dalla corrosione sia di agenti atmosferici che di fertilizzanti chimici, colori stabilizzati da trattamento U.V., resistente a sbalzi termici da -60° C a + 90° C. Diffusore direzionabile.

LED Lampadine LED GU10 3,5W incluse.
CCT regolabile: 2700 K, 4000 K.



096483

096476

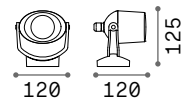

0,500 Kg / 0,0027 m³
GU10 max 1x6W

€ 82

096483 ■ Bianco
096476 ■ Nero

4000 K
430 lm
253497 € 3,00



P. 926



Litio

Corpo luce e diffusore in resina ad alte prestazioni: inattaccabile dalla corrosione sia di agenti atmosferici che di fertilizzanti chimici, colori stabilizzati da trattamento U.V., resistente a sbalzi termici da -60°C a $+90^{\circ}\text{C}$. Diffusore direzionabile.

LED Lampadine LED GX53 7W incluse.
CCT regolabile: 3000 K, 4000 K, 6500 K.



145303



145327



145341

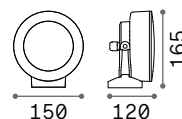

0,690 Kg / 0,0044 m³
GX53 max 1x10W

€ 95

145303 ■ Bianco
145327 ■ Grigio
145341 ■ Nero

4000 K
1000 lm

154008 € 5,00



P. 926



Terra

Montatura in fusione d'alluminio verniciata. Corpo luce posizionabile. Diffusore in vetro pirex trasparente.

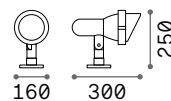

■ IP65

1,140 Kg / 0,0091 m³
E27 max 1x 42W

€ 85

046167 ■ Antracite

4000 K
580 lm

151960 € 2,00

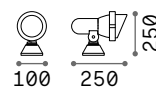

■ IP65

0,530 Kg / 0,0024 m³
GU10 max 1x 28W

€ 45

046181 ■ Antracite

4000 K
430 lm

253497 € 3,00



P. 925



Gas

Corpo luce in alluminio pressofuso verniciato a polveri. Diffusore in vetro temperato trasparente sabbiato. Colori: antracite, bianco, coffee o nero.

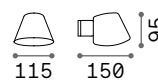

IP43

0,320 Kg / 0,0020 m³
GU10 max 1x28W

€ 50

091518 ■ Bianco
091525 ■ Antracite
020228 ■ Nero
213095 ■ Coffee

4000 K
430 lm

253497 € 3,00



091518

091525

020228

213095



P. 891



Xeno

Corpo luce in alluminio rifinito con vernice opaca a polveri. Diffusori orientabili con vetro temperato trasparente. Disponibile nelle finiture bianco, grigio o nero.



129488



129464



129471

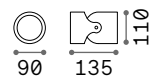

90 135

IP44

0,360 Kg / 0,0014 m³
GU10 max 1x28W

€ 40

129488 ■ Bianco
129471 ■ Grigio
129464 ■ Nero

4000 K
430 lm

253497 € 3,00



Swipe

Corpo luce in alluminio verniciato a polveri. Diffusore orientabile con schermo in policarbonato opale lucido. Disponibile con sensore crepuscolare e di movimento. Finiture: antracite, bianco, grigio, coffee oppure nero.

LED Sorgente luminosa LED 3000 K, 50.000 h di durata.



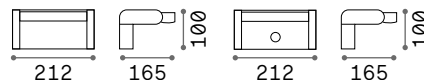

 Lampada con rilevazione di presenza inclusa PIR (Passive InfraRed).



 IP54

1,200 Kg / 0,0055 m³
LED 20,5W / 2300 lm





€ 120

287690  Bianco
326863  Grigio
287683  Antracite
287706  Nero
307169  Coffee

 IP54 

1,300 Kg / 0,0055 m³
LED 21W / 2300 lm

€ 130

287720  Bianco
326870  Grigio
287713  Antracite
287737  Nero
307176  Coffee



Style

Corpo luce in alluminio verniciato a polveri. Diffusore in materiale plastico opale. Sorgente luminosa a led integrato. Modello AP Sensor dotato di sensore PIR. Disponibile nelle finiture antracite, bianco, coffee, grigio o nero.

LED Sorgente luminosa LED
3000/4000 K, 30.000 h di durata.

 Lampada con rilevazione di presenza inclusa PIR (Passive InfraRed).



269139

322650

246857

322636

322704

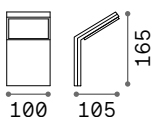

 IP54

0,390 Kg / 0,0018 m³
LED 8,5W / 950/1050 lm

€ 135

269139	Bianco	3000K
221502	Bianco	4000K
322650	Grigio	3000K
322643	Grigio	4000K
246857	Antracite	3000K

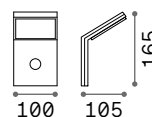

 IP54 

0,400 Kg / 0,0018 m³
LED 9W / 950/1050 lm

€ 165

269146	Bianco	3000K
209852	Bianco	4000K
246864	Antracite	3000K
221519	Antracite	4000K

209845	Antracite	4000K
322636	Nero	3000K
322629	Nero	4000K
322704	Coffee	3000K
322681	Coffee	4000K





Tronco

Corpo luce in alluminio pressofuso rifinito in vernice di colore antracite, bianco, coffee, grigio o nero. Diffusore in vetro pirex con elementi interni in alluminio.

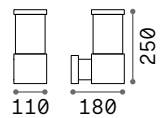

■ IP44

1,110 Kg / 0,0070 m³
E27 max 1x 42W

€ 65

118659 Bianco
026978 Grigio
027005 Antracite
004716 Nero
326962 Coffee

4000 K
490 lm
153957 € 2,00



Etere

Corpo luce in alluminio pressofuso verniciato a polveri. Diffusore in policarbonato opale satinato. Colori: antracite, coffee o nero.

LED Sorgente luminosa LED
3000/4000 K, 25.000 h di durata.

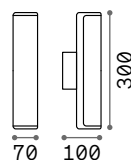

IP44

0,590 Kg / 0,0027 m³
LED 9,5W / 1000/1100 lm

€ 95

246925	■ Antracite	3000K
172408	■ Antracite	4000K
322193	■ Nero	3000K
322209	■ Nero	4000K
269153	■ Coffee	3000K
246949	■ Coffee	4000K



Snif Round

Corpo luce in alluminio pressofuso verniciato. Doppio diffusore, superiore e inferiore, in vetro pirex trasparente. Disponibile nelle finiture antracite, bianco, grigio o nero.

061467



144283



061474



061450

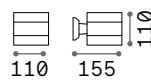

IP54

0,750 Kg / 0,0032 m³
G9 max 1x40W

€ 50

144283 ■ Bianco
061474 ■ Grigio
061467 ■ Antracite
061450 ■ Nero

4000 K
530 lm
307879 € 6,00



Snif Square

Corpo luce in alluminio pressofuso verniciato. Doppio diffusore, superiore e inferiore, in vetro pirex trasparente. Disponibile nelle finiture antracite, bianco, grigio o nero.

121963



144276



118666



123080

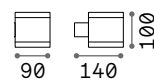

IP44

0,600 Kg / 0,0027 m³
G9 max 1x 40W

€ 50

144276 **Bianco**
118666 **Grigio**
121963 **Antracite**
123080 **Nero**

4000 K
530 lm
307879 € 6,00

Keope

Corpo luce e diffusore in resina ad alte prestazioni: inattaccabile dalla corrosione di agenti atmosferici; colori stabilizzati da trattamento U.V.. Resistente a sbalzi termici da -60° C a + 90° C. Diffusori in materiale acrilico trasparente satinato.

LED Lampadine LED GU10 3,5W incluse.
CCT regolabile: 2700 K, 4000 K.

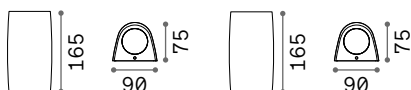

0,450 Kg / 0,0033 m³
GU10 max 2x6W

€ 63

147772 ■ Bianco
147796 ■ Grigio
147819 ■ Nero

0,350 Kg / 0,0033 m³
GU10 max 1x6W

€ 42

147765 ■ Bianco

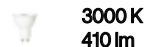

108292 € 3,00

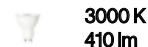

108292 € 3,00



Apollo

Corpo luce in alluminio pressofuso rifinito con vernice opaca a polveri in colore nero. Emissione luce sopra e sotto.

LED Sorgente luminosa LED 4000 K,
30.000 h di durata.



0,540 Kg / 0,0008 m³
LED 6W / 800 lm

€ 90

137391 ■ Nero





Base

Corpo luce in alluminio pressofuso verniciato a polveri. Diffusori in vetro temperato trasparente.
Colori: bianco o nero.



129457

129433

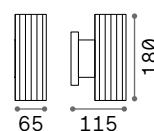

■  IP44

0,610 Kg / 0,0016 m³
GU10 max 2 x 28W

€ 40

129457 ■ Bianco
129433 ■ Nero

 4000 K
430 lm

253497 € 3,00



Gun

Corpo luce in alluminio con finitura naturale spazzolata o in vernice con varie finiture. Diffusore in vetro pirex trasparente. Emissione luce sopra e sotto.



100388

033013

163628



236841

100395

163635

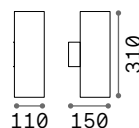

110

150

310



1,350 Kg / 0,0071 m³
E27 max 2 x 60W

€ 72

092300 ■ Bianco
033020 ■ Alluminio
163604 ■ Grigio
236858 ■ Antracite
092317 ■ Nero
163611 ■ Coffee

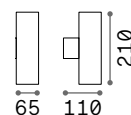

65

110

210



0,720 Kg / 0,0024 m³
GU10 max 2 x 35W

€ 65

100388 ■ Bianco
033013 ■ Alluminio
163628 ■ Grigio
236841 ■ Antracite
100395 ■ Nero
163635 ■ Coffee

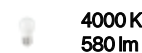

151960 4000 K
580 lm € 2,00

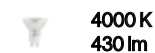

253497 4000 K
430 lm € 3,00



P. 810



Punto

Base e corpo luce in alluminio verniciato a polveri. Diffusori in vetro. Emissione luce indiretta. Finiture: antracite, bianco, coffee, nero.



Sorgente luminosa LED 3000 K, 30.000 h di durata.



313528

313511

313542

313535

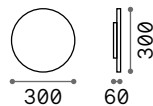

2,090 Kg / 0,0135 m³
LED 16W / 1750 lm

€ 150

328553 Bianco
313566 Antracite
328577 Nero
328560 Coffee

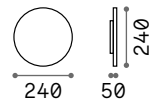

1,280 Kg / 0,0083 m³
LED 12W / 1250 lm

€ 125

328522 Bianco
313559 Antracite
328546 Nero
328539 Coffee

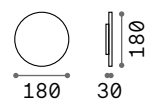

0,820 Kg / 0,0018 m³
LED 9W / 950 lm

€ 65

313528 Bianco
313511 Antracite
313542 Nero
313535 Coffee



Toffee ^{new}

Base e corpo luce in alluminio verniciato a polveri. Diffusore in vetro temperato trasparente. Emissione indiretta. Colori: antracite, bianco, coffe o nero.

LED Sorgente luminosa LED 3000 K, 50.000 h di durata.

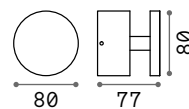

IP65

0,400 Kg / 0,0011 m³
LED 8W / 800 lm

€ 75

347738 **Bianco** ^{new}
321189 **Antracite** ^{new}
321196 **Nero** ^{new}
321202 **Coffee** ^{new}



347738

321189

321196

321202



P. 866



P. 866



Linea

Base e corpo luce in alluminio verniciato a polveri. Diffusori in vetro. Emissione luce indiretta. Finiture: antracite, bianco, coffee, nero.

LED Sorgente luminosa LED 3000 K, 30.000 h di durata.



IP54	IP54
1,750 Kg / 0,0049 m³ LED 23W / 2400 lm	1,430 Kg / 0,0036 m³ LED 20W / 1950 lm
€ 185	€ 145
328584 Bianco 313504 Antracite 328607 Nero 328591 Coffee	313474 Bianco 313467 Antracite 313498 Nero 313481 Coffee



Iko

Corpo luce in alluminio pressofuso verniciato a polveri. Doppio diffusore, superiore e inferiore, in vetro temperato trasparente e sabbato. Disponibile nelle finiture antracite, bianco o grigio.

018515



092218



018522

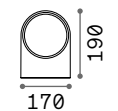
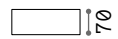

IP54

0,600 Kg / 0,0040 m³
E27 max 1x60W

€ 50

018522 ■ Bianco
092218 ■ Grigio
018515 ■ Antracite

 4000 K
580 lm

151960 € 2,00



Sirio new

Corpo luce in alluminio pressofuso verniciato a polveri. Diffusore in vetro temperato trasparente. Sorgente GX53. Colori: antracite, bianco, coffee, grigio o nero.

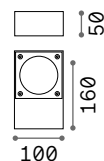

IP65

0,820 Kg / 0,0018 m³
GX53 max 1x9W

€ 90

318226 ■ Bianco new
345611 ■ Grigio new
318202 ■ Antracite new
318219 ■ Nero new
318196 ■ Coffee new



318226

318196

345611

318219

318202



P. 886



P. 924



4000 K
1000 lm

154008

€ 5,00



Rubik

Corpo luce in fusione di alluminio verniciato a polveri. Struttura interna che riflette il fascio luminoso sia sopra sia sotto. Disponibile nelle finiture antracite, bianco, coffee, grigio o nero.

LED Sorgente luminosa LED 3000/4000 K, 30.000 h di durata.



■ IP54

0,660 Kg / 0,0022 m³
LED 8,5W / 660/720 lm

€ 142

269313	■ Bianco	3000K
149745	■ Bianco	4000K
326849	■ Grigio	3000K
326856	■ Grigio	4000K
247083	■ Antracite	3000K

149738	■ Antracite	4000K
269320	■ Nero	3000K
142302	■ Nero	4000K
326627	■ Coffee	3000K
326634	■ Coffee	4000K



Atom

Corpo luce in alluminio verniciato a polveri. Diffusori in vetro. Doppio fascio luminoso, sopra e sotto, ad ampiezza regolabile con alette mobili.

LED Sorgente luminosa LED 3000 K, 30.000 h di durata.

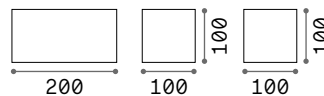

■ \oplus IP54

1,160 Kg / 0,0025 m³
LED 25W / 2100 lm

€ 135

328652 ■ Bianco
313412 ■ Antracite
328676 ■ Nero
328669 ■ Coffee

■ \oplus IP54

0,660 Kg / 0,0013 m³
LED 12W / 1050 lm

€ 70

313436 ■ Bianco
313429 ■ Antracite
313450 ■ Nero
313443 ■ Coffee

Up

Corpo luce in fusione di alluminio verniciato a polveri. Diffusori in vetro pirex trasparente. Disponibile nelle finiture antracite, bianco, coffee, grigio o nero.



0,520 Kg / 0,0019 m³
G9 max 2 x 15W

0,320 Kg / 0,0012 m³
G9 max 1 x 15W

€ 40

€ 25

115320 ■ Bianco
326993 ■ Grigio
115337 ■ Antracite
115344 ■ Nero
213354 ■ Coffee

115290 ■ Bianco
326986 ■ Grigio
115306 ■ Antracite
115313 ■ Nero
213347 ■ Coffee

4000 K
530 lm

4000 K
530 lm

307879 € 6,00

307879 € 6,00



Tetris-1

Corpo luce in alluminio rifinito con vernice opaca a polveri. Diffusore in vetro temperato trasparente. Disponibile nelle finiture antracite, bianco, coffee, grigio o nero.

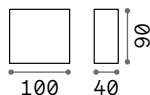

0,390 Kg / 0,0017 m³
G9 max 1 x 15W

€ 82

114293 ■ Bianco
113760 ■ Grigio
113753 ■ Antracite
326955 ■ Nero
213323 ■ Coffee

4000 K
530 lm

307879 € 6,00



Tetris-2

Corpo luce in alluminio rifinito con vernice opaca a polveri di colore antracite o bianco. Diffusore in vetro temperato trasparente. Emissione luce sopra e sotto.

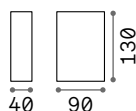

IP44

0,520 Kg / 0,0018 m³

G9 max 2 x 15W

€ 91

269221 Bianco

113791 Antracite

4000 K
530 lm

307879 € 6,00



Argo

Corpo luce in alluminio pressofuso verniciato a polveri. Diffusore in vetro temperato trasparente con riflettore interno bianco. Disponibile nelle finiture antracite o bianco.

LED Sorgente luminosa LED
3000/4000 K, 30.000 h di durata.

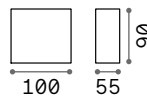

IP65

0,600 Kg / 0,0013 m³

LED 11W / 1000/1150 lm

€ 80

268309 Bianco 3000K

268316 Bianco 4000K

250946 Antracite 3000K

268293 Antracite 4000K

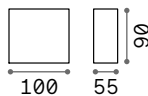

IP65

0,600 Kg / 0,0011 m³

LED 6W / 550/570 lm

€ 70

317564 Bianco 3000K

321691 Bianco 4000K

321646 Antracite 3000K

317571 Antracite 4000K





Twin



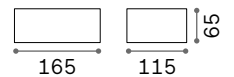

Corpo luce in alluminio pressofuso verniciato a polveri di colore antracite, bianco, coffee, grigio o nero. Doppio diffusore, superiore e inferiore, in vetro pirex trasparente satinato.



■  IP44

0,510 Kg / 0,0026 m³
G9 max 1x28W

€ 55

- 115351  Bianco
- 326979  Grigio
- 115368  Antracite
- 115375  Nero
- 213330  Coffee

 4000 K
530 lm
307879 € 6,00



Andromeda

Corpo luce in alluminio pressofuso verniciato. Doppio diffusore, superiore e inferiore, in vetro pirex satinato. Disponibile nelle finiture antracite, bianco, coffee, grigio o nero.

100364



163543



092355



100371



163550

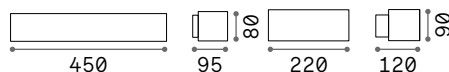

IP55

1,630 Kg / 0,0052 m³
E27 max 2x60W

€ 85

100364 Bianco
163543 Grigio
092355 Antracite
100371 Nero
163550 Coffee

4000 K
580 lm

151960 € 2,00

IP55

1,000 Kg / 0,0039 m³
E27 max 1x60W

€ 55

066868 Bianco
158822 Grigio
061580 Antracite
061597 Nero
163536 Coffee

4000 K
580 lm

151960 € 2,00



Giove

Corpo luce in alluminio pressofuso verniciato a polveri. Doppio diffusore, superiore e inferiore, in vetro temperato trasparente sabbato. Disponibile nelle finiture antracite, bianco, coffee, grigio o nero.

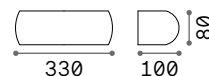

IP54

0,900 Kg / 0,0041 m³
E27 max 1x 60W

€ 70

092195 ■ Bianco
322605 ■ Grigio
092188 ■ Antracite
092201 ■ Nero
163598 ■ Coffee

4000 K
580 lm

151960 € 2,00











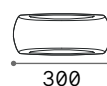

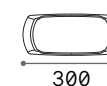



Felix

Corpo luce e diffusore in resina ad alte prestazioni: inattaccabile dalla corrosione sia di agenti atmosferici che di fertilizzanti chimici, colori stabilizzati da trattamento U.V., resistente a sbalzi termici da -60°C a $+90^{\circ}\text{C}$.

LED

Lampadine LED E27 8W Goccia incluse nel modello **123745**. CCT regolabile: 2700 K, 4000 K, 6500 K.

	123776				
		300	85	130	
					
					
		0,520 Kg / 0,0050 m³	E27 max 1x23W	0,610 Kg / 0,0050 m³	E27 max 1x23W
		€ 52		€ 35	
		123745	Bianco	123776	Bianco
				123769	Grigio
				123783	Nero
			4000 K		4000 K
		580 lm		580 lm	
		151960	€ 2,00	151960	€ 2,00



Rex-1

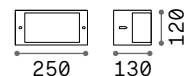

Corpo luce in alluminio pressofuso verniciato a polveri di colore antracite, bianco, coffee, grigio o nero. Diffusore bianco in materiale acrilico.



■  IP44

0,600 Kg / 0,0065 m³
E27 max 1x 60W

€ 42

092393  Bianco
322735  Grigio
092409  Antracite
322728  Nero
213217  Coffee

 4000 K
1020 lm

151991 € 2,00

Rex-2

Corpo luce in alluminio pressofuso verniciato a polveri di colore antracite o bianco. Diffusore bianco in materiale acrilico.

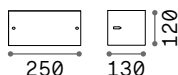

IP44

0,600 Kg / 0,0065 m³
E27 max 1x60W

€ 42

092416 **Bianco**
092423 **Antracite**

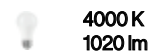

151991 € 2,00



Rex-3

Corpo luce in alluminio pressofuso verniciato a polveri di colore antracite o bianco. Diffusore bianco in materiale acrilico.

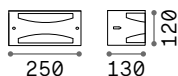

IP44

0,600 Kg / 0,0065 m³
E27 max 1x60W

€ 42

092430 **Bianco**
092447 **Antracite**

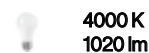

151991 € 2,00





Cometa

Corpo luce in alluminio pressofuso verniciato a polveri. Diffusore in PVC bianco. È sconsigliato esporre l'articolo a contatto diretto con i raggi solari. Colore: antracite.

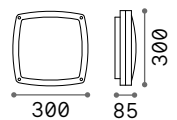

1,500 Kg / 0,0124 m³
E14 max 3x28W

€ 100

082240 ■ Antracite

 3000 K
420 lm

101217 € 2,00

Polar

Corpo luce e diffusore in resina ad alte prestazioni: inattaccabile dalla corrosione sia di agenti atmosferici che di fertilizzanti chimici, colori stabilizzati da trattamento U.V., resistente a sbalzi termici da -60°C a $+90^{\circ}\text{C}$.

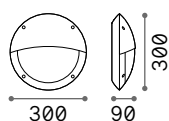
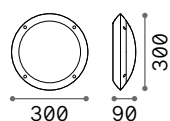

0,800 Kg / 0,0106 m³
E27 max 1x23W

0,800 Kg / 0,0106 m³
E27 max 1x23W

€ 35

€ 35

096667 Bianco
096674 Nero

096681 Bianco
096698 Nero

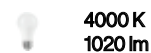
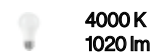

151991 € 2,00

151991 € 2,00



Medea

Corpo luce e diffusore in resina ad alte prestazioni: inattaccabile dalla corrosione sia di agenti atmosferici che di fertilizzanti chimici, colori stabilizzati da trattamento U.V., resistente a sbalzi termici da -60°C a $+90^{\circ}\text{C}$.

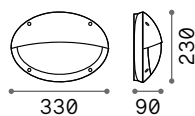
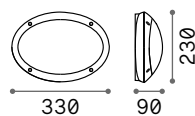

0,800 Kg / 0,0109 m³
E27 max 1x23W

0,800 Kg / 0,0109 m³
E27 max 1x23W

€ 25

€ 25

096711 Bianco
096704 Nero

096735 Bianco
096728 Nero

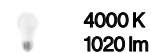
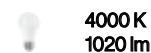

151991 € 2,00

151991 € 2,00





Bubble

Montatura in alluminio pressofuso e tornito rifinito con vernici a polveri. Diffusore in materiale plastico bianco opaco.

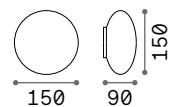

0,480 Kg / 0,0031 m³
G9 max 2x15W

€ 72

158907 Bianco

4000 K
530 lm

307879 € 6,00



P. 812



Snow new

Base e diffusore in policarbonato bianco. Fissaggio a incastro, senza viti a vista. Colore: bianco.

LED Sorgente luminosa LED 3000 K / 4000 K, 50.000 h di durata.

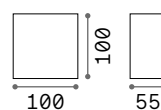

0,170 Kg / 0,0013 m³
LED 6W / 550/600 lm

€ 25

326214 Bianco 3000K^{new}
326221 Bianco 4000K^{new}



P. 805



Clio

Articolo componibile con montatura in alluminio estruso e tornito, rifinito con vernici a polveri di colore antracite, bianco, grigio, nero e coffee. Diffusore in materiale plastico bianco opaco.

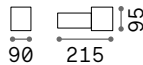

IP44

0,680 Kg / 0,0039 m³
E27 max 1x42W

€ 80

- 146775 Bianco
- 146782 Grigio
- 145228 Antracite
- 146799 Nero
- 326788 Coffee

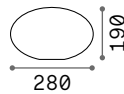

0,540 Kg / 0,0171 m³

€ 40

145068 Bianco

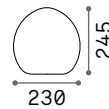

0,520 Kg / 0,0144 m³

€ 40

116716 Bianco

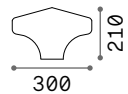

0,610 Kg / 0,0231 m³

€ 40

145020 Bianco



P. 806 P. 806 P. 908

4000 K
580 lm
151960 € 2,00

Cima

Corpo luce interamente in alluminio pressofuso. Con finitura antracite, coffee o nero e oro. Diffusore in acrilico trasparente.

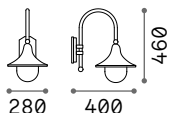

■ IP43

1,840 Kg / 0,0504 m³
E27 max 1x52W

€ 61

246819 ■ Antracite
024134 ■ Nero
246826 ■ Coffee

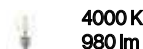

153964 € 3,50



P. 910



Dafne

Corpo luce in resina ad alte prestazioni: inattaccabile dalla corrosione, colori stabilizzati da trattamento U.V., resistente a sbalzi termici da -60° C a +90° C. Diffusore in metacrilato antingiallimento.

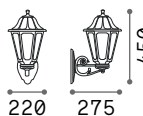

■ IP55

1,000 Kg / 0,0101 m³
E27 max 1x23W

€ 33

120423 ■ Bianco
101491 ■ Nero



153964 € 3,50

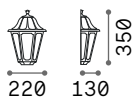

■ IP55

0,600 Kg / 0,0117 m³
E27 max 1x23W

€ 28

120430 ■ Bianco
101552 ■ Nero

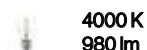

153964 € 3,50



P. 911



Down

Montatura in alluminio pressofuso verniciato a polveri con finitura antracite o bianca. Diffusore in acrilico.

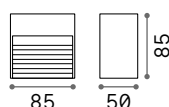

■ IP44

0,270 Kg / 0,0010 m³
G9 max 1x28W

€ 30

115382 ■ Bianco
122045 ■ Antracite

4000 K
530 lm

307879 € 6,00



Febe

Apparecchio da installazione su superficie con corpo luce in alluminio pressofuso verniciato a polveri. Diffusore in vetro temperato trasparente. Colore: antracite.

LED Sorgente luminosa LED 3000/4000 K, 30.000 h di durata.



■ IP65

0,760 Kg / 0,0020 m³
LED 6W / 600/630 lm

€ 75

250854 ■ Antracite 3000K
322285 ■ Antracite 4000K

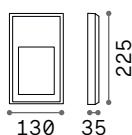

■ IP65

0,760 Kg / 0,0020 m³
LED 6W / 500/520 lm

€ 75

268354 ■ Antracite 3000K
322308 ■ Antracite 4000K





Dedra

Corpo luce in alluminio pressofuso verniciato a polveri. Diffusore in acrilico trasparente. Emissione luce indiretta. Finiture: bianco, antracite, coffee.

LED Sorgente luminosa LED 3000 K, 20.000 h di durata.

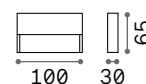
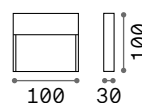

■ □ IP65

■ □ IP65

0,200 Kg / 0,0007 m³
LED 1,5W / 160 lm

0,170 Kg / 0,0007 m³
LED 1,5W / 160 lm

€ 47

€ 43

328638 ■ Bianco
316871 ■ Antracite
328621 ■ Coffee

316901 ■ Bianco
328645 ■ Antracite
316895 ■ Coffee



Bollard e lampade da tavolo

Esterni

Indice alfabetico

Acqua	903	Tifone	892
Agos	882	Titano	888
Arcadia	881	Toffee	866
Atena	900	Torre	906
Boeing	896	Tronco	898
Cima	910	Twiggy	874
Clio	908	Vega	893
Cosmo	907		
Cute	868		
Dafne	911		
Doris	876		
Edo Outdoor	901		
Enya	872		
Etere	904		
Gas	891		
Hub	891		
Ipotesi	873		
Itaca	880		
Jedi	894		
Kurt	889		
Lolita	870		
Luna	878		
Marte	902		
Mercurio	902		
Pulsar	903		
Pure	864		
Sasso	879		
Sirio	886		
Sole	877		
Style	884		
Tesla	890		

Enya

Pag 872



Pure 864

Toffee 866

Cute 868

Lolita 870



Itaca 880

Arcadia 881

Agos 882

Style 884



Vega 893

Jedi 894

Boeing 896

Tronco 898

Esterni

Indice icone



Enya 872

Ipotesi 873

Twigg 874

Doris 876

Sole 877

Luna 878

Sasso 879



Sirio 886



Titano 888



Kurt 889



Tesla 890



Gas 891



Hub 891



Tifone 892



Atena 900



Edo Outdoor 901



Marte 902



Mercurio 902



Pulsar 903



Acqua 903



Etere 904



Torre 906



Cosmo 907



Clio 908



Clio 908



Clio 908



Cima 910







Dafne 911



Pure

Base, stelo e paralume in metallo verniciato opaco. Diffusore in acrilico. Batteria ricaricabile e interruttore touch integrato. Finiture: bianco, coffee, nero. Tempo di ricarica della batteria 6 ore.

-  Sorgente luminosa LED 3000 K, 30.000 h di durata.
-  Lampada con interruttore integrato.
-  Lampada con dimmer.
-  Lampada con dimmer tattile.
-  Lampada con batteria ricaricabile inclusa. Durata 7 ore.



 IP54

1,580 Kg / 0,0058 m³
LED 1,5W / 230 lm

€ 115

311708  Bianco
328515  Nero
328508  Coffee

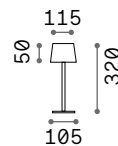

 IP54

0,840 Kg / 0,0052 m³
LED 1,5W / 230 lm





€ 85

311685  Bianco
311678  Nero
311661  Coffee







Toffee new

Lampada da tavolo a batteria
 Ricaricabile. Corpolute in alluminio
 verniciato a polveri. Diffusore in
 acrilico. Colori: bianco, coffee o nero.

-  Sorgente luminosa LED 3000 K, 20.000 h di durata.
-  Lampada con interruttore integrato. Cod. **328614, 311715, 347868**
-  Lampada con interruttore tattile. Cod. **328614, 311715, 347868**
-  Lampada con batteria ricaricabile inclusa. Durata 8 ore. Cod. **328614, 311715, 347868**



 IP65	 IP65	 IP65	 IP65	 IP54
1,400 Kg / 0,0200 m³ LED 11W / 1200 lm	1,220 Kg / 0,0200 m³ LED 11W / 1200 lm	0,950 Kg / 0,0200 m³ LED 8W / 800 lm	0,830 Kg / 0,0200 m³ LED 8W / 800 lm	0,460 Kg / 0,0050 m³ LED 2W / 230 lm
€ 130	€ 125	€ 105	€ 100	€ 90
347837 ■ Antracite <small>new</small>	347806 ■ Antracite <small>new</small>	347776 ■ Antracite <small>new</small>	347745 ■ Antracite <small>new</small>	311715 ■ Bianco
347851 ■ Nero <small>new</small>	347820 ■ Nero <small>new</small>	347790 ■ Nero <small>new</small>	347769 ■ Nero <small>new</small>	328614 ■ Nero
347844 ■ Coffee <small>new</small>	347813 ■ Coffee <small>new</small>	347783 ■ Coffee <small>new</small>	347752 ■ Coffee <small>new</small>	347868 ■ Coffee <small>new</small>







Cute new

Lampada a batteria con base di ricarica. Montatura in metallo verniciato a polveri. Diffusore acrilico con emissione luce in basso. Colori: bianco, nero, coffee, cromo, oro.

LED Sorgente luminosa LED 2200 K / 2700 K, 50.000 h di durata.

ON OFF Lampada con interruttore integrato.

 Lampada con dimmer.

 Lampada con dimmer tattile.

 Lampada con batteria ricaricabile inclusa.

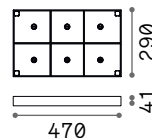
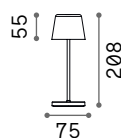

 IP65







 IP20

0,440 Kg / 0,0026 m³
LED 2,5W / 190 lm

1,920 Kg / 0,0092 m³

€ 85

€ 180

- | | | | | | |
|--------|--|--------------------|--------|--|--------------------|
| 346892 |  Bianco | <small>new</small> | 348377 |  Nero | <small>new</small> |
| 346922 |  Cromo | <small>new</small> | | | |
| 346908 |  Nero | <small>new</small> | | | |
| 346915 |  Coffee | <small>new</small> | | | |
| 346939 |  Oro | <small>new</small> | | | |

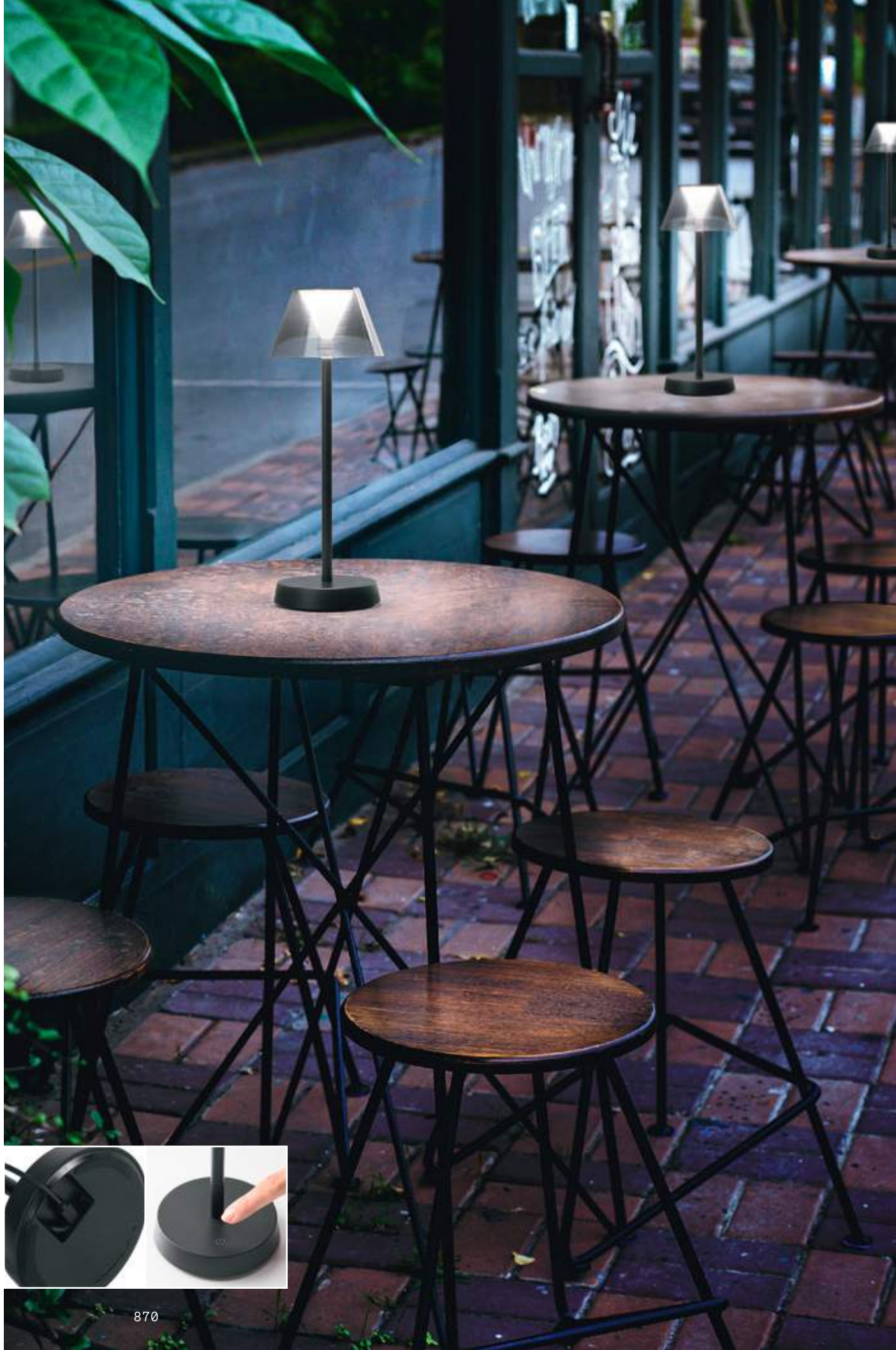



Lolita

Lampada da tavolo a batteria ricaricabile con finitura bianca, grigia, nera o coffee. Base in plastica. Montatura in metallo. Diffusore in materiale plastico. Autonomia di 14 ore. Tempo di ricarica della batteria 7 ore.

LED Sorgente luminosa LED 3000 K, 25.000 h di durata.

ON OFF Lampada con interruttore integrato.

 Lampada con dimmer.

 Lampada con dimmer tattile.



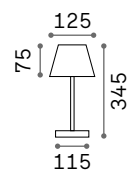

 Lampada con batteria ricaricabile inclusa. Durata 14 ore.



 IP54

0,550 Kg / 0,0078 m³
LED 1,8W / 150 lm

€ 55

286723  Bianco
286730  Grigio
286716  Nero
286747  Coffee



Enya ^{new}

Lampada portatile a batteria, ricaricabile. Corpuluce in alluminio verniciato a polveri. Maniglia in gomma nera. Diffusore in vetro temperato. Emissione luce in basso. Interruttore con dimmer. Colori: bianco, nero, coffee.

LED Sorgente luminosa LED
3000 K, 35.000 h di durata.

ON OFF Lampada con interruttore integrato.

Hand icon Lampada con dimmer tattile.

Battery icon Lampada con batteria ricaricabile inclusa.



IP54

1,490 Kg / 0,0086 m³
LED 5W / 250 Lm

€ 115

323251 **Bianco** ^{new}

323237 **Nero** ^{new}

323244 **Coffee** ^{new}



Ipotesi

Montatura interamente in alluminio verniciato a polveri. Diffusore in policarbonato opale. Cavo nero in gomma con interruttore, driver esterno incorporato e spina. Colore: bianco o nero.

LED Sorgente luminosa LED
3000 K, 30.000 h di durata.

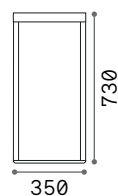

350

730

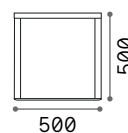

500

500

IP44

IP44

5,100 Kg / 0,1041 m³
LED 16W / 1700 Lm

4,940 Kg / 0,1379 m³
LED 16W / 1700 Lm

€ 335

€ 435

282244 ■ Bianco
282251 ■ Nero

300641 ■ Bianco
300658 ■ Nero



282244



282251



Twiggy new

Montatura in alluminio verniciato a polveri. Diffusore in acrilico satinato. Fornito con picchetto. Colori: nero e coffee.

LED Sorgente luminosa LED 3000 K, 30.000 h di durata.



347905

347875

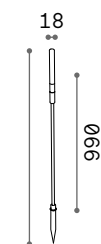

IP65

0,290 Kg / 0,0031 m³
LED 1,5W / 130 lm

€ 50

348346 ■ Nero
348339 ■ Coffee

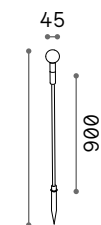

IP65

0,031 Kg / 0,0028 m³
LED 1,5W / 130 lm

€ 60

new 348360 ■ Nero
new 348353 ■ Coffee

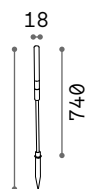

IP65

0,210 Kg / 0,0023 m³
LED 1,5W / 130 lm

€ 45

new 347882 ■ Nero
new 347875 ■ Coffee

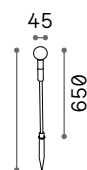

IP65

0,230 Kg / 0,0020 m³
LED 1,5W / 130 lm

€ 55

new 347905 ■ Nero
new 347899 ■ Coffee

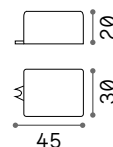

Driver
Non incluso
Necessario

€ 12

new 276205



Doris

Diffusore in materiale plastico grigio melange effetto granito. Fornito con spina e picchetto per fissaggio nel terreno.

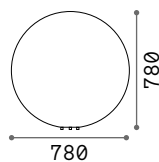

7,600 Kg / 0,5581 m³
E27 max 1x60W

€ 545

195506 Bianco

4000 K
1020 lm

151991 € 2,00

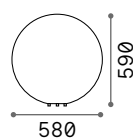

4,050 Kg / 0,2306 m³
E27 max 1x60W

€ 325

195490 Bianco

4000 K
1020 lm

151991 € 2,00

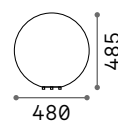

3,000 Kg / 0,1366 m³
E27 max 1x60W

€ 215

195483 Bianco

4000 K
1020 lm

151991 € 2,00

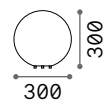

1,210 Kg / 0,0318 m³
E27 max 1x60W

€ 127

214009 Bianco

4000 K
1020 lm

151991 € 2,00



Sole

Diffusore in materiale plastico opale. Fornito con spina e picchetto per terreno.

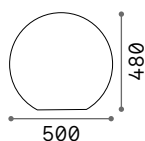

4,500 Kg / 0,1460 m³
E27 max 1x 60W

€ 225

191614 Bianco

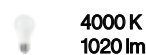

151991 € 2,00

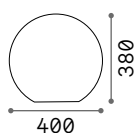

3,900 Kg / 0,0741 m³
E27 max 1x 60W

€ 150

191621 Bianco

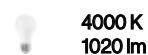

151991 € 2,00

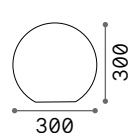

2,700 Kg / 0,0322 m³
E27 max 1x 60W

€ 120

191638 Bianco

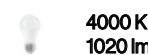

151991 € 2,00

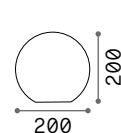

1,200 Kg / 0,0139 m³
E27 max 1x 60W

€ 110

318820 Bianco

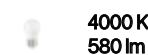

151960 € 2,00



P. 802



Luna

Corpo luce diffusore in materiale plastico opale. Fornito con spina e picchetto per terreno.

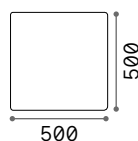

IP44

6,700 Kg / 0,1743 m³
E27 max 1x60W

€ 290

191607 Bianco

4000 K
1020 lm

151991 € 2,00

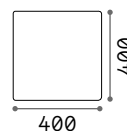

IP44

4,700 Kg / 0,1005 m³
E27 max 1x60W

€ 210

191584 Bianco

4000 K
1020 lm

151991 € 2,00

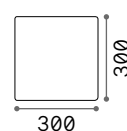

IP44

2,700 Kg / 0,0356 m³
E27 max 1x60W

€ 150

191577 Bianco

4000 K
1020 lm

151991 € 2,00



P. 804



Sasso

Diffusore in materiale plastico opale. Fornito di cavo con spina e picchetto per fissaggio a terra.

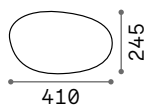

1,500 Kg / 0,0444 m³
E27 max 1x 40W

€ 205

161778 Bianco

4000 K
1020 lm
151991 € 2,00

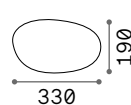

0,900 Kg / 0,0209 m³
E27 max 1x 40W

€ 145

161761 Bianco

4000 K
1020 lm
151991 € 2,00

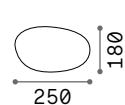

0,710 Kg / 0,0123 m³
G9 max 1x 15W

€ 105

161754 Bianco

4000 K
530 lm
307879 € 6,00



Itaca

Base e stelo in metallo verniciato a polveri di colore bianco. Diffusore conico in materiale plastico color opale. Fornito con spina.

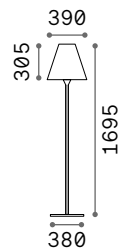

IP44

8,840 Kg / 0,1405 m³
E27 max 1x60W

€ 310

180953 Bianco

4000 K
1020 lm

151991 € 2,00



Arcadia

Base e stelo in metallo verniciato a polveri. Diffusore in PMMA bianco. Cavo in neoprene con spina. Finiture: antracite.

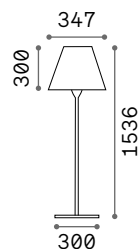

6,500 Kg / 0,0525 m³
E27 max 1x42W

€ 115

298610 ■ Antracite

4000 K
1020 lm

151991 € 2,00

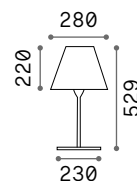

2,940 Kg / 0,0247 m³
E27 max 1x42W

€ 150

298597 ■ Antracite

4000 K
1020 lm

151991 € 2,00



Agos

Corpo luce in alluminio pressofuso verniciato a polveri. Diffusore in acrilico trasparente satinato. Colore antracite, coffee e nero.

LED Sorgente luminosa LED
3000/4000 K, 25.000 h di durata.



254388

326696

326689

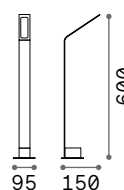
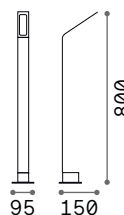

1,100 Kg / 0,0127 m³
LED 6,5W / 670/730 lm

0,950 Kg / 0,0096 m³
LED 6,5W / 670/730 lm

€ 100

€ 80

254319 ■ Antracite 3000K
268422 ■ Antracite 4000K
326733 ■ Nero 3000K
326757 ■ Nero 4000K
326726 ■ Coffee 3000K
326740 ■ Coffee 4000K

254388 ■ Antracite 3000K
268439 ■ Antracite 4000K
326696 ■ Nero 3000K
326719 ■ Nero 4000K
326689 ■ Coffee 3000K
326702 ■ Coffee 4000K



Style

Corpo luce in alluminio verniciato a polveri. Diffusore in materiale plastico opale. Sorgente luminosa a led integrato. Disponibile nelle finiture antracite, bianco, coffee, grigio o nero.

LED Sorgente luminosa LED
3000/4000 K, 30.000 h di durata.

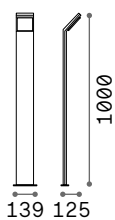

IP54

1,680 Kg / 0,0239 m³
LED 8,5W / 950/1050 lm

€ 190

318707	Bianco	3000K
322483	Bianco	4000K
322384	Grigio	3000K
322353	Grigio	4000K
246871	Antracite	3000K

209906	Antracite	4000K
322230	Nero	3000K
322216	Nero	4000K
322452	Coffee	3000K
322438	Coffee	4000K

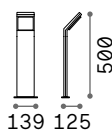

IP54

1,200 Kg / 0,0122 m³
LED 8,5W / 950/1050 lm

€ 145

318691	Bianco	3000K
322582	Bianco	4000K
322551	Grigio	3000K
322544	Grigio	4000K
322612	Antracite	3000K

322599	Antracite	4000K
322537	Nero	3000K
322506	Nero	4000K
322575	Coffee	3000K
322568	Coffee	4000K



Sirio

Corpo luce in alluminio verniciato a polveri. Diffusore in vetro pirex trasparente. Disponibile nelle finiture antracite, bianco, coffee, grigio o nero.



115085

246963

115061

115108

213262

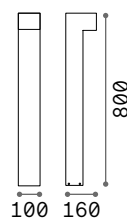

IP44

1,880 Kg / 0,0181 m³
G9 max 2x15W

€ 180

115085 Bianco
246963 Grigio
115061 Antracite
115108 Nero
213262 Coffee

307879 4000 K
530 lm
€ 6,00

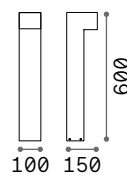

IP44

1,550 Kg / 0,0136 m³
G9 max 2x15W

€ 145

115092 Bianco
246970 Grigio
115078 Antracite
115115 Nero
213279 Coffee

307879 4000 K
530 lm
€ 6,00



Titano

Corpo luce in resina porosa. Base e dettaglio diffusore in metallo verniciato nero opaco. Emissione luce verso il basso. LED integrato.



LED Sorgente luminosa LED
3000/4000 K, 50.000 h di durata.

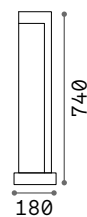

IP55

9,220 Kg / 0,0540 m³
LED 8,5W / 560/580 lm

€ 350

246987 ■ Granito 3000K
187327 ■ Granito 4000K

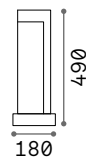

IP55

6,800 Kg / 0,0377 m³
LED 8,5W / 560/580 lm

€ 275

246994 ■ Granito 3000K
157856 ■ Granito 4000K



Kurt

Base e corpo luce in alluminio verniciato a polveri. Diffusore in vetro temperato trasparente. Emissione luce verso il basso. Colori: antracite, bianco, coffee o nero.

LED

Sorgente luminosa LED
3000/4000 K, 30.000 h di durata.

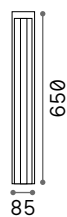

IP54

1,930 Kg / 0,0060 m³
LED 11W / 1150/1200 lm

€ 125



306841

306834

306872

306858

306841	Bianco	3000K	306872	Nero	3000K
294049	Bianco	4000K	293172	Nero	4000K
306834	Antracite	3000K	306858	Coffee	3000K
294025	Antracite	4000K	294001	Coffee	4000K



Tesla

Corpo luce in alluminio verniciato a polveri. Diffusore con schermo in materiale plastico bianco. Emissione luce verso il basso. Disponibile nelle finiture antracite, bianco, coffee, nero.

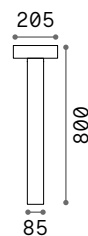

IP44

3,000 Kg / 0,0379 m³
G9 max 4 x 15W

€ 155

153179 **Bianco**
153162 **Antracite**
316055 **Nero**
326924 **Coffee**

4000 K
530 lm
307879 € 6,00

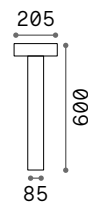

IP44

2,560 Kg / 0,0273 m³
G9 max 4 x 15W

€ 145

153209 **Bianco**
153193 **Antracite**
326917 **Nero**
316048 **Coffee**

4000 K
530 lm
307879 € 6,00

Gas

Corpo luce in alluminio pressofuso verniciato a polveri. Diffusore in vetro temperato trasparente sabbiato. Disponibile nelle finiture antracite, bianco, coffee, grigio o nero.

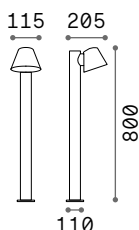

IP43

1,790 Kg / 0,0216 m³
GU10 max 1x35W

€ 116

139470 ■ Antracite
322421 ■ Nero
213101 ■ Coffee

4000 K
430 lm

253497

€ 3,00

P. 823



Hub

Base, asta e corpo luce in alluminio verniciato a polveri. Diffusore orientabile con schermo in vetro temperato trasparente. Fornito di picchetto per fissaggio a terra. Disponibile nella finitura antracite.

LED Sorgente luminosa LED
3000 K, 30.000 h di durata.

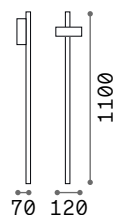

IP54

0,850 Kg / 0,0057 m³
LED 4,5W / 390 lm

€ 132

251257 ■ Antracite

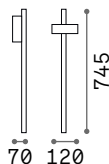

IP54

0,720 Kg / 0,0083 m³
LED 4,5W / 390 lm

€ 132

251226 ■ Antracite



Base
Non incluso
Optional

€ 32

251295 ■ Antracite





Tifone

Base e montatura in alluminio pressofuso verniciato a polveri con finitura antracite. Diffusore in vetro temperato trasparente. Emissione luce in basso.

LED Sorgente luminosa LED
3000 K, 20.000 h di durata.

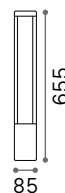

IP65

1,250 Kg / 0,0054 m³
LED 8,5W / 710 Lm

€ 122

250953 ■ Antracite

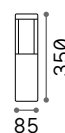

IP65

1,010 Kg / 0,0029 m³
LED 8,5W / 710 Lm

€ 105

250977 ■ Antracite



Vega

Corpo luce in alluminio con finitura in vernice opaca a polveri. Diffusore in vetro temperato trasparente. Disponibile nelle finiture antracite, bianco, coffee, grigio o nero.



136035 136042 136028 136059 213361

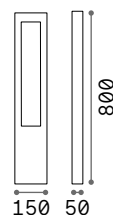

IP44

1,150 Kg / 0,0092 m³
G9 max 1x 15W

€ 180

- 136035 Bianco
- 136042 Grigio
- 136028 Antracite
- 136059 Nero
- 213361 Coffee

4000 K
530 lm
307879 € 6,00



Jedi

Base e corpo luce in alluminio verniciato a polveri. Diffusore in policarbonato opale lucido. Fornito con picchetto per installazione su terreno. Finiture: antracite oppure nero.

LED Sorgente luminosa LED
3000 K, 30.000 h di durata.



306803



293202

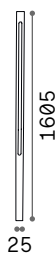

1,280 Kg / 0,0065 m³
LED 25W / 2600 Lm

€ 155

306803 ■ Antracite
293202 ■ Nero

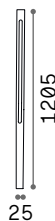

1,030 Kg / 0,0150 m³
LED 19W / 2050 Lm

€ 125

306797 ■ Antracite
293196 ■ Nero

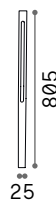

0,760 Kg / 0,0036 m³
LED 12W / 1250 Lm

€ 90

306780 ■ Antracite
293189 ■ Nero



Base
Non incluso
Optional

€ 13

308227 ■ Antracite
308234 ■ Nero



Boeing new

Corpo luce in alluminio pressofuso verniciato a polveri. Diffusore composto da protezione esterna in policarbonato trasparente fumè ed elemento interno in acrilico opale satinato che orienta la luce in basso. Colori: antracite, coffee, nero.

LED Sorgente luminosa LED 3000 K, 50.000 h di durata.



4,000 Kg / 0,0232 m³
LED 14W / 1200 lm

€ 210



3,100 Kg / 0,0164 m³
LED 14W / 1200 lm

€ 180

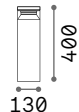

2,200 Kg / 0,0097 m³
LED 14W / 1200 lm

€ 160



1,350 Kg / 0,0041 m³
LED 14W / 1200 lm

€ 140

- | | | | |
|---------------------------------------|---------------------------------------|---------------------------------------|---------------------------------------|
| 327266 ■ Antracite <small>new</small> | 327259 ■ Antracite <small>new</small> | 327242 ■ Antracite <small>new</small> | 346656 ■ Antracite <small>new</small> |
| 346731 ■ Nero <small>new</small> | 346717 ■ Nero <small>new</small> | 346694 ■ Nero <small>new</small> | 346670 ■ Nero <small>new</small> |
| 346724 ■ Coffee <small>new</small> | 346700 ■ Coffee <small>new</small> | 346687 ■ Coffee <small>new</small> | 346663 ■ Coffee <small>new</small> |



Tronco

Corpo luce in alluminio pressofuso rifinito in vernice di colore antracite, bianco, coffee, grigio o nero. Diffusore in vetro pirex con elementi interni in alluminio.

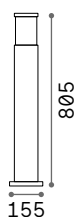

IP65

2,490 Kg / 0,0254 m³
E27 max 1x42W

€ 160

109138 Bianco
026961 Grigio
026992 Antracite
004723 Nero
163741 Coffee



4000 K
490 lm

153957 € 2,00

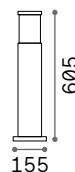

IP65

1,970 Kg / 0,0193 m³
E27 max 1x42W

€ 138

109145 Bianco
026954 Grigio
026985 Antracite
004730 Nero
163758 Coffee



4000 K
490 lm

153957 € 2,00

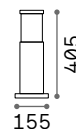

IP65

0,590 Kg / 0,0135 m³
E27 max 1x42W

€ 125

248264 Bianco
248288 Grigio
248257 Antracite
248295 Nero
248271 Coffee



4000 K
490 lm

153957 € 2,00





Atena

Corpo luce e diffusore in resina ad alte prestazioni: anti corrosione, colori stabilizzati da trattamento U.V., resistente da -60° C a + 90° C.

LED

Lampadine LED E27 8W Goccia incluse. CCT regolabile: 2700 K, 4000 K, 6500 K.

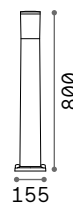

IP55

1,070 Kg / 0,0220 m³
E27 max 1x23W

€ 83

198644 Bianco
198637 Grigio
198620 Nero

 4000 K
1020 lm

151991 € 2,00



Edo Outdoor

Montatura in fusione d'alluminio verniciato a polveri di colore antracite, bianco o coffee. Diffusore in policarbonato bianco.



142999



135762



213071

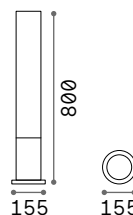

IP44

1,600 Kg / 0,0240 m³
GX53 max 1x15W

€ 132

135755 Bianco
138510 Antracite
213071 Coffee

4000 K
1000 lm
154008 € 5,00

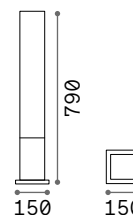

IP44

2,670 Kg / 0,0269 m³
GX53 max 1x15W

€ 132

142999 Bianco
135762 Antracite
213088 Coffee

4000 K
1000 lm
154008 € 5,00

Marte

Corpo luce in alluminio verniciato a polveri con finitura antracite. Diffusore bianco in materiale acrilico.

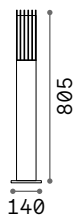

IP44

2,500 Kg / 0,0193 m³

E27 max 1x 25W

€ 160

092225 ■ Antracite

4000 K
580 lm

151960 € 2,00



Mercurio

Corpo luce in alluminio verniciato a polveri con finitura antracite. Diffusore in vetro pirex trasparente.

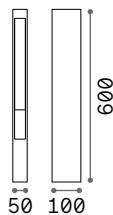

IP44

1,540 Kg / 0,0057 m³

G9 max 1x 15W

€ 160

114347 ■ Antracite

4000 K
530 lm

307879 € 6,00



Pulsar

Corpoluce in alluminio pressofuso verniciato a polveri. Diffusore in policarbonato opale satinato. Colori: antracite o coffee.

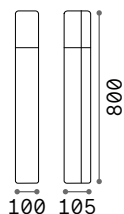

1,900 Kg / 0,0120 m³
E27 max 1x 42W

€ 200

135908 ■ Antracite
246888 ■ Coffee

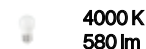

151960 € 2,00



Acqua

Corpo luce in alluminio tornito rifinito in vernice opaca con finitura antracite o coffee. Diffusore in vetro temperato.

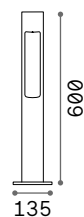

1,500 Kg / 0,0164 m³
G9 max 1x 15W

€ 160

135205 ■ Antracite
246918 ■ Coffee

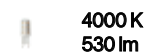

307879 € 6,00





Etere

Corpo luce in alluminio pressofuso verniciato a polveri. Diffusore in policarbonato opale satinato.
Colori: antracite, coffee o nero.

LED Sorgente luminosa LED
3000/4000 K, 25.000 h di durata.

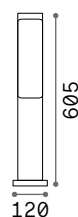

IP44

1,100 Kg / 0,0103 m³
LED 9,5W / 1000/1100 lm

€ 127

246932	■	Antracite	3000K
172439	■	Antracite	4000K
322261	■	Nero	3000K
322278	■	Nero	4000K
269160	■	Coffee	3000K
246956	■	Coffee	4000K



Torre

Corpo luce in alluminio tornito verniciato a polveri con finitura antracite, bianco, coffee, grigio o nero. Diffusore in materiale plastico opale.

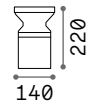
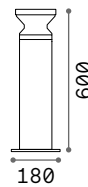

2,600 Kg / 0,0307 m³
E27 max 1x 15W

2,100 Kg / 0,0224 m³
E27 max 1x 15W

0,870 Kg / 0,0054 m³
E27 max 1x 15W

€ 180

€ 168

€ 144

321851 ■ Grigio
321882 ■ Antracite
321639 ■ Nero
321868 ■ Coffee

321905 ■ Grigio
162492 ■ Antracite
186955 ■ Nero
321929 ■ Coffee

321950 ■ Grigio
158891 ■ Antracite
186979 ■ Nero
321981 ■ Coffee

4000 K
580 lm

4000 K
580 lm

4000 K
580 lm

151960 € 2,00

151960 € 2,00

151960 € 2,00



321950

158891

186979

321981



Cosmo

Corpo luce in resina resistente a corrosione, UV, a temperature da -60° a +90° C. Diffusore trasparente anti ingiallimento.

LED

Lampadine LED GX53 10W incluse.
CCT regolabile: 3000 K, 4000 K, 6500 K.



187877

187884

187891

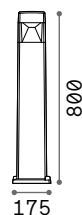

IP55

2,150 Kg / 0,0220 m³
GX53 max 1x10W

€ 115

187877 Bianco
187884 Grigio
187891 Nero

154008 4000 K
1000 lm
€ 5,00



P. 806 P. 806 P. 856

Clio

Articolo componibile con montatura in alluminio estruso e tornito, rifinito con vernici a polveri di colore antracite, bianco, grigio, nero e coffee. Diffusore in materiale plastico bianco opaco.



IP44

1,360 Kg / 0,0087 m³
E27 max 1x 42W

€ 95

- 249469 Bianco
- 249476 Grigio
- 249452 Antracite
- 249483 Nero
- 328829 Coffee

4000 K
580 lm
151960 € 2,00

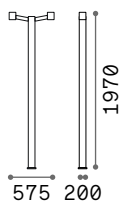

IP44

7,250 Kg / 0,0384 m³
E27 max 2x 42W

€ 285

- 249506 Bianco
- 249513 Grigio
- 249490 Antracite
- 249520 Nero
- 328836 Coffee

4000 K
580 lm
151960 € 2,00

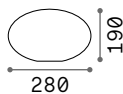

0,540 Kg / 0,0171 m³

€ 40

145068 Bianco

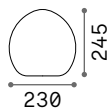

0,520 Kg / 0,0144 m³

€ 40

116716 Bianco

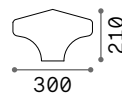

0,610 Kg / 0,0231 m³

€ 40

145020 Bianco



Cima

Corpo luce interamente in alluminio pressofuso. Con finitura antracite, coffee o nero e oro. Diffusore in acrilico trasparente.



246833

024097

246840

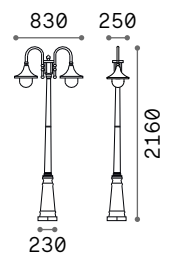

IP43

3,340 Kg / 0,1467 m³
E27 max 2 x 52W

€ 330

246833 ■ Antracite
024097 ■ Nero
246840 ■ Coffee

4000 K
980 lm

153964 € 3,50



P. 857



Dafne

Corpo luce in resina ad alte prestazioni: inattaccabile dalla corrosione, colori stabilizzati da trattamento U.V., resistente a sbalzi termici da -60° C a +90° C. Diffusore in metacrilato antingiallimento.

LED Lampadine LED E27 8W Goccia incluse. CCT regolabile: 2700 K, 4000 K, 6500 K.



120454



101514



2,500 Kg / 0,0446 m³
E27 max 1x 23W

€ 85

120454 ■ Bianco
101514 ■ Nero

 4000 K
980 lm

153964 € 3,50



P. 857













Proiettori

Esterni

Indice alfabetico

Elio	926
Inside	927
Koala	920
Litio	926
O-Zone	916
Sirio	924
Starlight	918
Terra	925
Thor	914
Ulex	922

Indice icone

<small>new</small>	<small>new</small>	<small>new</small>
		
Thor 914	O-zone 916	Starlight 918
<small>new</small>		
		
Koala 920	Ulex 922	Sirio 924
		
Terra 925	Elio 926	Litio 926
		
Inside 927		

Thor

Proiettore lineare orientabile per installazione in superficie con effetto di luce radente. Corpo in alluminio pressofuso, diffusore in vetro, alimentazione 24 VDC, indice di protezione IP65, resistenza all'urto IK06. Tecnologia LED SMD; CCT 3000 K, CRI ≥ 90 , SDCM ≤ 3 ; durata utile LED 50.000 h L70B50. Disponibile in opzione con visiera anti-abbagliamento.

Sorgente	LED SMD	Durata LED	50.000 h
Potenza	20W / 40W	Classe	III
Driver incluso	No	isolamento	
Driver disponibili	On/Off	IP	65
MacAdam	SDCM 3	Materiale	Alluminio
CCT	3000 K		
CRI	≥ 90		

PRO

Prodotto ad alto contenuto tecnologico, elevata qualità dei materiali, destinato ad uso professionale.

LED SMD OSRAM Driver non incluso

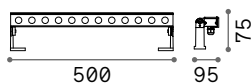

Potenza	Angolo	Lumen	CCT	Finitura	Codice	€
20 W	28°	1600 lm	3000 K	Antracite	261331	215

1,490 Kg/0,0057 m³
Lunghezza cavo 500 mm

LED SMD OSRAM Driver non incluso

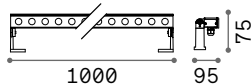

Potenza	Angolo	Lumen	CCT	Finitura	Codice	€
40 W	28°	2300 lm	3000 K	Antracite	261355	325

2,460 Kg/0,0108 m³
Lunghezza cavo 500 mm

OPTIONAL Non incluso



		Finitura	Codice	€
Visiera	18W	Antracite	261362	18
	40W	Antracite	261379	29

ON/OFF DRIVER Non incluso/Necessario

Potenza	Output	Misura	Codice	€
40 W	24 Vdc	171 x 37 x 61 mm	272108	100
100 W	24 Vdc	220 x 39 x 68 mm	226200	190
185 W	24 Vdc	220 x 39 x 68 mm	226217	210



P. 932





O-zone new

Corpo luce in alluminio pressofuso verniciato a polveri. Diffusore orientabile con vetro temperato trasparente. Colori: nero.

LED Sorgente luminosa LED 3000 K, 50.000 h di durata.



325019

<p>1,250 Kg / 0,0060 m³ LED 19W / 1700 lm</p>	<p>0,800 Kg / 0,0060 m³ LED 13W / 1150 lm</p>	<p>0,090 Kg / 0,0012 m³</p>
<p>€ 200</p>	<p>€ 135</p>	<p>€ 10</p>
<p>337531 ■ Nero</p>	<p><small>new</small> 325019 ■ Nero</p>	<p><small>new</small> 345673 ■ Nero <small>new</small></p>

Starlight

Proiettore orientabile in alluminio con fissaggio a plafone o con picchetto; superficie anodizzata e verniciata a polveri in grigio scuro; LED integrato ad efficienza energetica con elevata resa cromatica; disponibile in temperatura di colore 3000K e 4000K; durata utile LED 50.000 h. Visiera antiabbagliamento in opzione.

Sorgente	LED COB	Durata LED	50.000 h
Potenza	5,5W / 10W	Classe	III
Driver incluso	No	isolamento	
Driver disponibili	On/Off	IP	68
MacAdam	SDCM 3	Materiale	Alluminio
CCT	3000 K/ 4000 K		
CRI	≥90		

PRO

Prodotto ad alto contenuto tecnologico, elevata qualità dei materiali, destinato ad uso professionale.

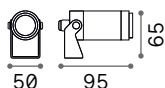

0,280 Kg/0,0005 m³

LED COB BRIDGELUX Driver non incluso

Potenza	Angolo	Lumen	CCT	Finitura	Codice	€
5,5 W	30°	500 lm	3000 K	Grigio Scuro	248394	120
		600 lm	4000 K	Grigio Scuro	245041	120

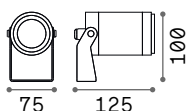

0,950 Kg/0,0014 m³

LED COB BRIDGELUX Driver non incluso

Potenza	Angolo	Lumen	CCT	Finitura	Codice	€
10 W	30°	930 lm	3000 K	Grigio Scuro	248387	250
		1000 lm	4000 K	Grigio Scuro	245072	250

OPTIONAL Non incluso



		Potenza	Finitura	Codice	€
Visiera		5,5W	Grigio Scuro	245096	34
		10W	Grigio Scuro	245102	34
Picchetto			Grigio Scuro	245089	17

ON/OFF DRIVER Non incluso/Necessario

Potenza	Output	Misura	Codice	€
20 W	24 Vdc	118 x 26 x 35 mm	226187	75
40 W	24 Vdc	148 x 30 x 40 mm	226194	80
100 W	24 Vdc	220 x 39 x 68 mm	226200	190
185 W	24 Vdc	220 x 39 x 68 mm	226217	210



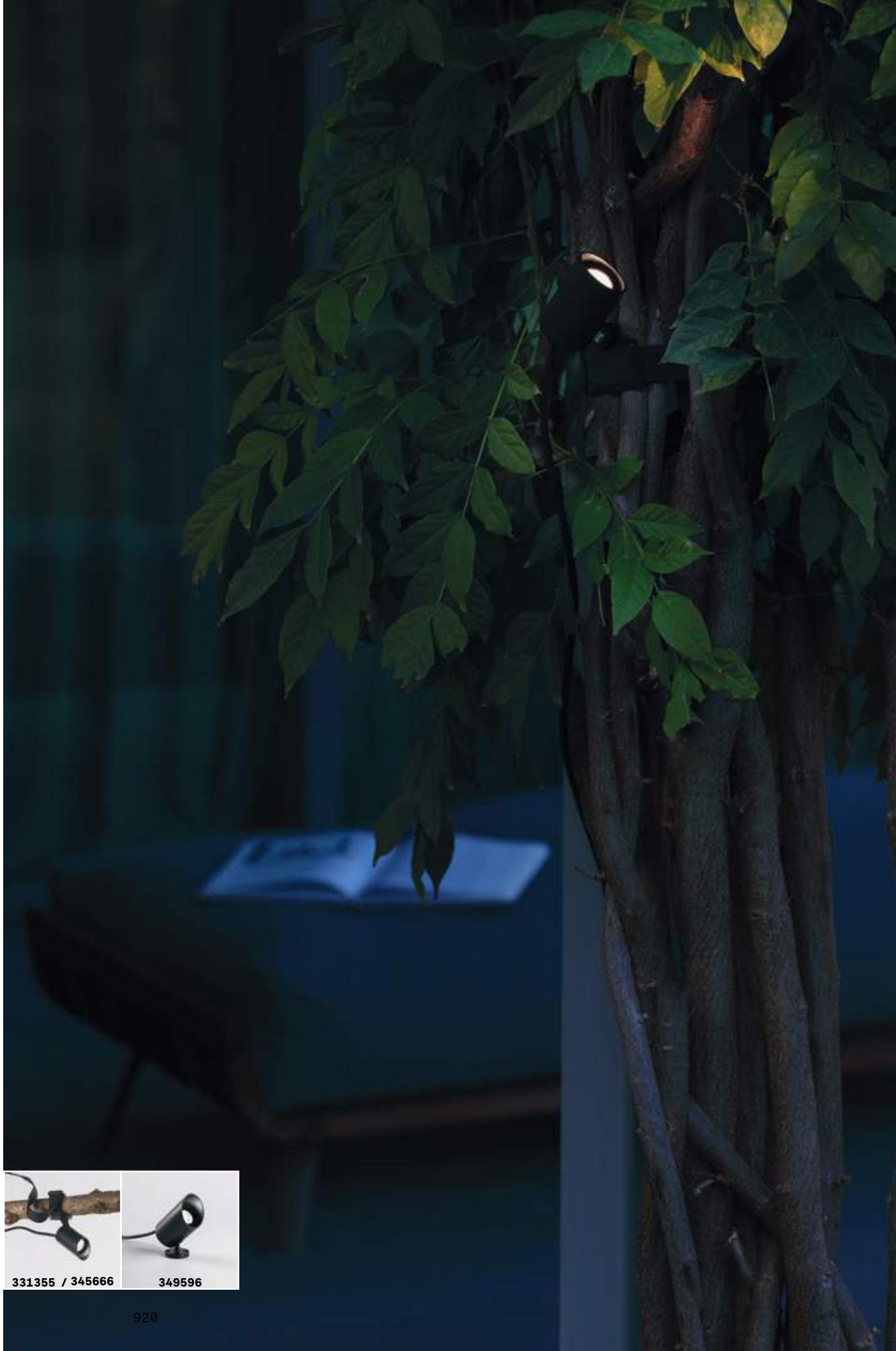

331355 / 345666

349596

Koala **new**

Corpo luce orientabile in alluminio pressofuso verniciato a polveri.
Diffusore in vetro temperato trasparente. Disponibile con base per fissaggio a parete e pavimento oppure con cinghia per fissaggio ad alberi o pali. Colori: nero.

LED Sorgente luminosa LED
3000 K, 35.000 h di durata.

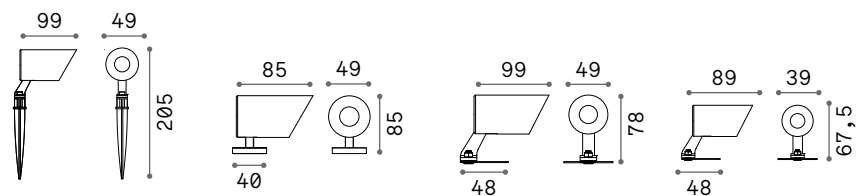

■ IP65

0,600 Kg / 0,0014 m³
LED 7W / 570 lm

€ 75

331386 ■ Nero

■ IP65

0,600 Kg / 0,0014 m³
LED 7W / 570 lm

€ 75

new 349596 ■ Nero

■ IP65

0,640 Kg / 0,0014 m³
LED 7W / 570 lm

€ 80

new 345666 ■ Nero

■ IP65

0,520 Kg / 0,0014 m³
LED 3W / 300 lm

€ 65

new 331355 ■ Nero

new

Ulex

Proiettore orientabile per installazione a superficie, adatto per illuminazione generale o d'accento in esterni. Corpo in alluminio pressofuso, diffusore in vetro trasparente. Sorgente luminosa a led integrato, disponibile in due potenze. Indice di protezione IP65, resistenza all'urto IK06, temperatura di colore 3000K; durata utile LED 50.000 h. Disponibile in opzione con basetta di cablaggio, picchetto per installazione a terreno o visiera anti-abbagliamento.

Sorgente	LED SMD	Classe	I
Potenza	8,5W / 15W	isolamento	
Driver incluso	On/Off	IP	65
Driver disponibili	No	Materiale	Alluminio
CCT	3000 K		
CRI	≥90		
Durata LED	50.000 h		

PRO Prodotto ad alto contenuto tecnologico, elevata qualità dei materiali, destinato ad uso professionale.

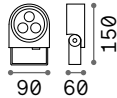

0,660 Kg/0,0025 m³
Lunghezza cavo 2000 mm

LED SMD OSRAM Driver ON/OFF incluso

Potenza	Angolo	Lumen	CCT	Finitura	Codice	€
8,5 W	30°	600 lm	3000 K	Antracite	261287	145

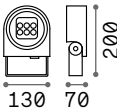

1,190 Kg/0,0042 m³
Lunghezza cavo 2000 mm

LED SMD OSRAM Driver ON/OFF incluso

Potenza	Angolo	Lumen	CCT	Finitura	Codice	€
15 W	30°	1200 lm	3000 K	Antracite	261294	220

OPTIONAL Non incluso



		Finitura	Codice	€
Box	8,5 W	Antracite	268156	32
	15 W	Antracite	268187	49



		Finitura	Codice	€
Picchetto	8,5 W	Antracite	268163	14
	15 W	Antracite	268194	17



		Finitura	Codice	€
Visiera	8,5 W	Antracite	268170	17
	15 W	Antracite	268200	25





Sirio new

Corpo luce orientabile in alluminio pressofuso verniciato a polveri. Diffusore in vetro temperato trasparente. Sorgente GX53. Colori: antracite, bianco, coffee, grigio o nero.

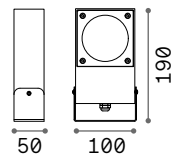

IP65

1,070 Kg / 0,0021 m³
GX53 max 1x9W

€ 110

345628	Bianco	new
345642	Grigio	new
318233	Antracite	new
345659	Nero	new
345635	Coffee	new



345628

345635

345642

345659

318233



P. 841



P. 886

4000 K
1000 lm

154008

€ 5,00



Terra

Montatura in fusione d'alluminio verniciata. Corpo luce posizionabile. Diffusore in vetro pirex trasparente.



106205



033037



163727



046211

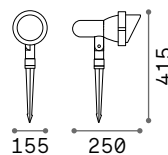

IP65

1,230 Kg / 0,0086 m³
E27 max 1x42W

€ 90

033044 ■ Antracite
321622 ■ Coffee

4000 K
580 lm

151960 € 2,00

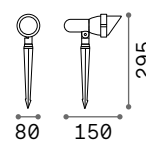

IP65

0,520 Kg / 0,0038 m³
GU10 max 1x28W

€ 52

106205 ■ Bianco
033037 ■ Antracite
046211 ■ Nero
163727 ■ Coffee

4000 K
430 lm

253497 € 3,00



P. 822

Elio

Corpo luce e diffusore in resina ad alte prestazioni: inattaccabile dalla corrosione sia di agenti atmosferici che di fertilizzanti chimici, colori stabilizzati da trattamento U.V., resistente a sbalzi termici da -60° C a + 90° C. Diffusore direzionabile.

LED Lampadine LED GU10 3,5W incluse.
CCT regolabile: 2700 K, 4000 K.

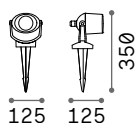

0,360 Kg / 0,0027 m³
GU10 max 1x6W

€ 82

120218 ■ Bianco
120201 ■ Nero

4000 K
430 lm

253497 € 3,00



P. 820



120218

120201

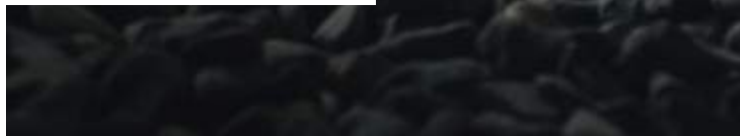

Litio

Corpo luce e diffusore in resina ad alte prestazioni: inattaccabile dalla corrosione sia di agenti atmosferici che di fertilizzanti chimici, colori stabilizzati da trattamento U.V., resistente a sbalzi termici da -60° C a + 90° C. Diffusore direzionabile.

LED Lampadine LED GX53 10W incluse.
CCT regolabile: 3000 K, 4000 K, 6500 K.

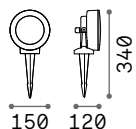

0,730 Kg / 0,0044 m³
GX53 max 1x10W

€ 90

145310 ■ Bianco
145334 ■ Grigio
145358 ■ Nero

4000 K
1000 lm

154008 € 5,00



P. 821



145310

145334

145358



Inside

Montatura in fusione d'alluminio verniciato a polveri con finitura antracite, coffee o grigio. Corpo luce posizionabile. Diffusore in vetro pirex trasparente. Dotato di lancia da interrare.

115412



115429



247045

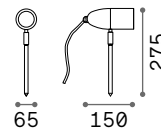

IP54

0,370 Kg / 0,0015 m³
G9 max 1x 15W

€ 36

115412 ■ Antracite

115429 ■ Nero

247045 ■ Coffee

4000 K
530 lm

307879

€ 6,00



Incassi

Esterni

Indice alfabetico

Bit	930
Floor	933
Gravity	937
Indio	931
Landing	938
Park	936
Rocket	941
Rocket-Mini	940
Rocket-Ultramini	941
Taurus	934
Thor	932
Way	939
Wire	930

Indice icone

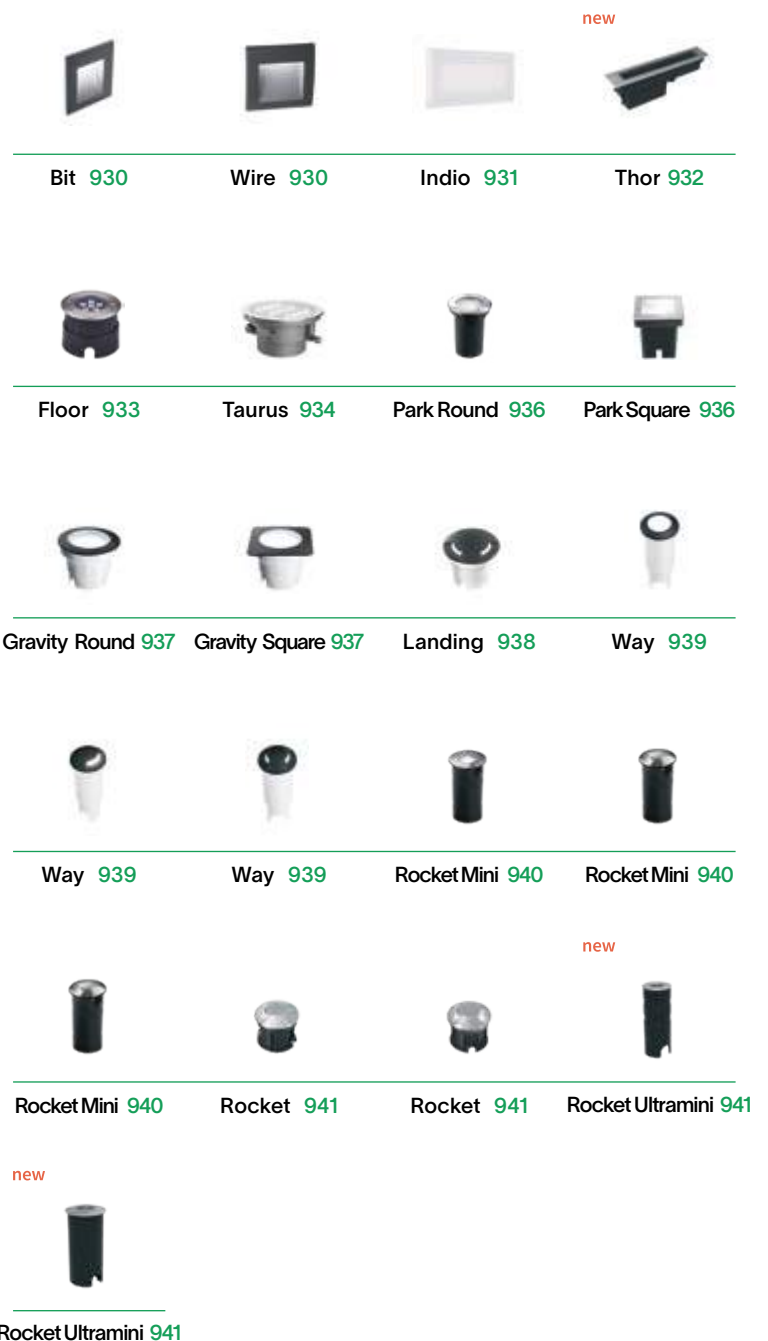

Bit

Corpo luce da incasso in alluminio pressofuso verniciato a polveri. Diffusore in vetro temperato trasparente. Disponibile nelle finiture antracite o bianco.

LED Sorgente luminosa LED 3000 K, 35.000 h di durata.

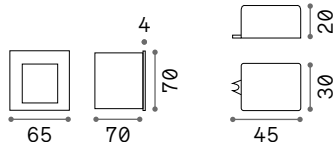

IP65

0,300 Kg / 0,0006 m³
LED 3W / 450 lm

€ 55

269023 **Bianco**
269009 **Antracite**

Driver
Non incluso
Necessario

€ 12

276205

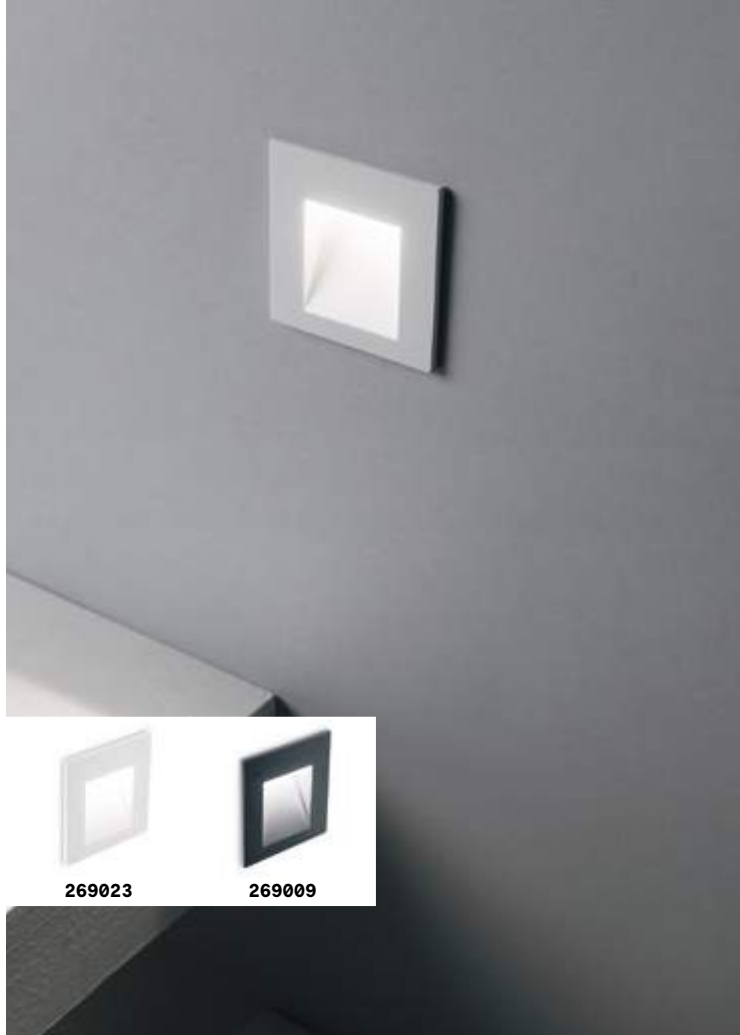

Wire

Corpo luce da incasso in alluminio pressofuso verniciato a polveri. Diffusore in vetro temperato trasparente. Disponibile nelle finiture antracite o bianco.

LED Sorgente luminosa LED 3000 K, 20.000 h di durata.

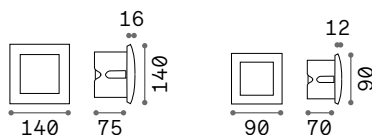

IP65

0,460 Kg / 0,0018 m³
LED 4W / 180 lm

€ 56

268989 **Bianco**
255514 **Antracite**

IP65

0,220 Kg / 0,0009 m³
LED 1,5W / 90 lm

€ 38

268996 **Bianco**
255521 **Antracite**





Indio

Corpo luce a incasso in alluminio pressofuso verniciato a polveri. Diffusore in vetro temperato serigrafato in bianco.

LED Sorgente luminosa LED 3000 K, 35.000 h di durata.

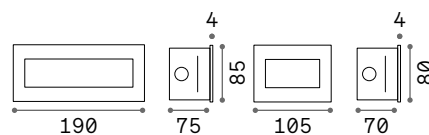

IP65

IP65

1,090 Kg / 0,0023 m³
LED 8W / 920 lm

0,540 Kg / 0,0011 m³
LED 5W / 420 lm

€ 144

€ 95

255804 Bianco

255781 Bianco



Thor **new**

Proiettore lineare per installazione a incasso nel pavimento. Corpo in alluminio pressofuso, ghiera in acciaio inox 316L, diffusore in vetro, indice di protezione IP67, resistenza all'urto IK08, cassaforma inclusa. Blocco ottico orientabile di +/- 20° per effetto di luce asimmetrica. Tecnologia LED SMD; CCT 3000 K, CRI ≥ 90, SDCM ≤ 3; durata utile LED 50.000 h L70B50.

LED Sorgente luminosa LED 3000 K, 50.000 h di durata.

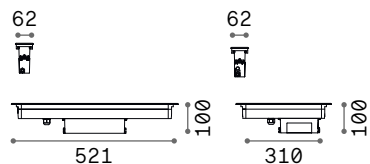

IP67

3,100 Kg / 0,0115 m³
LED 19W / 1800 lm

€ 415

351285 **Acciaio** **new** 351278 **Acciaio** **new**

IP67

2,000 Kg / 0,0075 m³
LED 10W / 900 lm

€ 250









P. 914

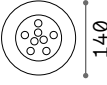
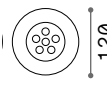

Floor

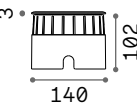
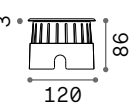
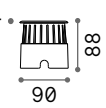
Incasso fisso da esterni in alluminio pressofuso con ghiera rotonda disponibile in tre dimensioni, adatto per installazione a terra e a pavimento. Finitura in alluminio anodizzato con diffusore in vetro temprato extrachiaro. LED integrati raffreddati passivamente con ottica di 30°; disponibile in temperatura di colore 3000 K e CRI \geq 80; grado di protezione IP 67; IK 10.

LED Sorgente luminosa LED 3000 K, 25.000 h di durata.

		
		
 IP67	 IP67	 IP67
0,960 Kg / 0,0049 m³ LED 12W / 1340 Lm	0,640 Kg / 0,0015 m³ LED 6W / 670 Lm	0,390 Kg / 0,0010 m³ LED 3,5W / 330 Lm
€ 106	€ 73	€ 55
255682 ■ Acciaio	255668 ■ Acciaio	255651 ■ Acciaio

Taurus

Proiettore da incasso per installazione a pavimento, parete o soffitto. Corpo in alluminio pressofuso, ghiera in acciaio inox 316L, diffusore in vetro, calpestabile (IP67, IK10), cassaforma inclusa. Moduli luminosi singolarmente orientabili di +/- 30° mediante perno esterno per restringere o direzionare il fascio luminoso. Tecnologia LED SMD; CCT 3000 K, CRI ≥ 90, SDCM ≤ 3; durata utile LED 50.000 h L70B50.

Sorgente	LED SMD	Classe	I
Potenza	6W / 21W	isolamento	
Driver incluso	On/Off	IP	67
Driver disponibili	No	Materiale	Alluminio
CCT	3000 K		
CRI	≥90		
Durata LED	50.000 h		

S316 Articolo in acciaio inox 316.

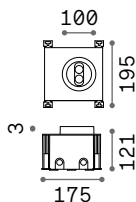

1,460 Kg/0,0129 m³

LED SMD OSRAM Driver ON/OFF incluso

Potenza	Lumen	CCT	Finitura	Codice	€
6W	400 lm	3000 K	Acciaio	277004	210

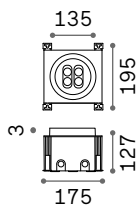

1,980 Kg/0,0071 m³

LED SMD OSRAM Driver ON/OFF incluso

Potenza	Lumen	CCT	Finitura	Codice	€
11W	790 lm	3000 K	Acciaio	277011	320

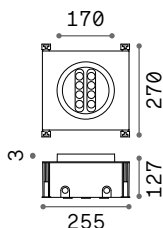

3,250 Kg/0,0133 m³

LED SMD OSRAM Driver ON/OFF incluso

Potenza	Lumen	CCT	Finitura	Codice	€
12W	1200 lm	3000 K	Acciaio	277028	405

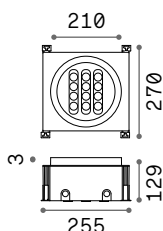

3,500 Kg/0,0242 m³

LED SMD OSRAM Driver ON/OFF incluso

Potenza	Lumen	CCT	Finitura	Codice	€
20W	1800 lm	3000 K	Acciaio	277035	530





Park

Spot da incasso. Corpo luce esterno in PVC. Parabola riflettente in alluminio. Cornice blocca vetro in acciaio satinato. Vetro trasparente.

IP67	IP67	IP54
1,210 Kg / 0,0066 m³ E27 max 1x28W	0,580 Kg / 0,0032 m³ GU10 max 1x20W	0,900 Kg / 0,0032 m³ G9 max 1x15W
€ 80	€ 57	€ 80
032825 ■ Acciaio	032832 ■ Acciaio	117881 ■ Acciaio
4000 K 980 lm	4000 K 430 lm	4000 K 530 lm
153964 € 3,50	253497 € 3,00	307879 € 6,00



Gravity

Corpo luce e diffusore in resina ad alte prestazioni: inattaccabile dalla corrosione sia di agenti atmosferici che di fertilizzanti chimici, colori stabilizzati da trattamento U.V., resistente a sbalzi termici da -60° C a + 90° C. Carrabile fino a 5000 Kg.

LED Lampadine LED GU10 3,5W e LED GX53 10W incluse. CCT regolabile.

IP67 <small>INCLUSA</small>	IP67 <small>INCLUSA</small>	IP67 <small>INCLUSA</small>	IP67 <small>INCLUSA</small>
0,670 Kg / 0,0043 m³ GX53 max 1x 10W	0,270 Kg / 0,0019 m³ GU10 max 1x 6W	0,700 Kg / 0,0043 m³ GX53 max 1x 10W	0,270 Kg / 0,0019 m³ GU10 max 1x 6W
€ 85	€ 58	€ 85	€ 58
120324 ■ Nero	120249 ■ Nero	120386 ■ Nero	120317 ■ Nero
4000 K 1000 lm	4000 K 430 lm	4000 K 1000 lm	4000 K 430 lm
154008 € 5,00	253497 € 3,00	154008 € 5,00	253497 € 3,00



Landing

Corpo luce e diffusore in resina ad alte prestazioni: inattaccabile dalla corrosione sia di agenti atmosferici che di fertilizzanti chimici, colori stabilizzati da trattamento U.V., resistente a sbalzi termici da -60° C a + 90° C. Carrabile fino a 5000 Kg.

LED

Lampadine LED GU10 3,5W e LED GX53 10W incluse. CCT regolabile.



120362



120287

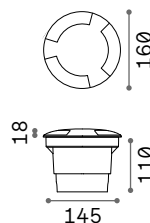

0,740 Kg / 0,0043 m³
GX53 max 1x 10W

€ 125

120362 ■ Nero

4000 K
1000 lm

154008 € 5,00

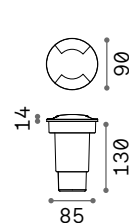

0,260 Kg / 0,0020 m³
GU10 max 1x 6W

€ 85

120287 ■ Nero

4000 K
430 lm

253497 € 3,00

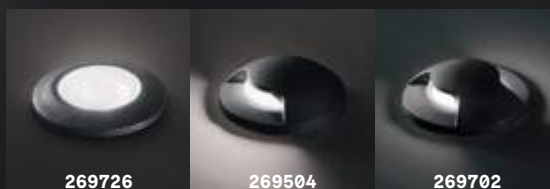

Way

Apparecchio da incasso calpestabile. Corpo luce e diffusore in resina ad alte prestazioni: anti corrosione, anti U.V., da -60°a +90° C. Colore: nero.

LED Lampadine LED G9 2W 3000/4000 K incluse. Cod. **270104/270111**

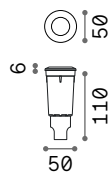

0,100 Kg / 0,0007 m³
G9 max 1x1,7W

€ 31

269726 ■ N 3000K
269733 ■ N 4000K

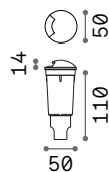

0,080 Kg / 0,0007 m³
G9 max 1x1,7W

€ 31

269504 ■ N 3000K
269696 ■ N 4000K

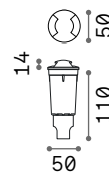

0,080 Kg / 0,0007 m³
G9 max 1x1,7W

€ 31

269702 ■ N 3000K
269719 ■ N 4000K

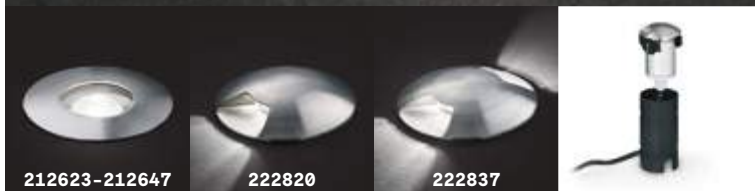

Rocket Mini

Diffusore in vetro temperato trasparente. Calpestabile. Sorgente luminosa a led integrato. Assenza di viti a vista. Disponibile nelle versioni a 1, 2 luci in radenza pavimento oppure con unica luce centrale d'accento.

LED

Sorgente luminosa LED 4000 K, 50.000 h di durata.

IP68

Grado di protezione IP68.

S316

Articolo in acciaio inox 316.

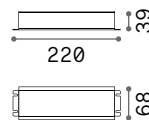
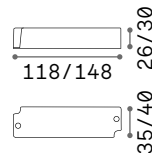
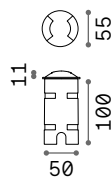
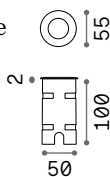

IP68

0,280 Kg / 0,0008 m³
LED 2W / 200 lm

€ 100

212623 ■ Acciaio 15°
212647 ■ Acciaio 40°

IP68

0,330 Kg / 0,0008 m³
LED 2W / 200 lm

€ 130 / 150

222820 ■ Acciaio
222837 ■ Acciaio

Driver
Non incluso
Necessario

€ 75 / 80

226187 20W
226194 40W

Driver
Non incluso
Necessario

€ 190 / 210

226200 100W
226217 185W

Rocket

Apparecchio da incasso calpestabile. Corpo luce in acciaio spazzolato. Diffusore in vetro temperato.

LED Sorgente luminosa LED 3000/4000 K, 30.000 h di durata.

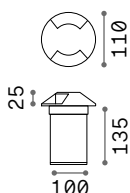
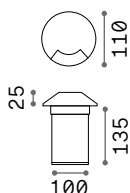

IP65

IP65

0,560 Kg / 0,0034 m³
LED 3W / 260/280 lm

0,560 Kg / 0,0034 m³
LED 3W / 260/280 lm

€ 135

€ 135

247144 Acciaio 3000K 247151 Acciaio 3000K
122014 Acciaio 4000K 122021 Acciaio 4000K



Rocket Ultramini new

Corpo luce in alluminio. Diffusore in vetro temperato trasparente.
Colore: acciaio spazzolato.

LED Sorgente luminosa LED 3000 K, 35.000 h di durata.

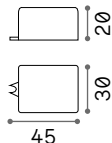
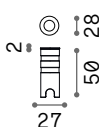
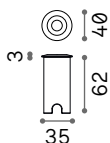

IP67

IP67

0,210 Kg / 0,0006 m³
LED 2,5W / 150 lm

0,210 Kg / 0,0006 m³
LED 1,3W / 80 lm

Driver
Non incluso
Necessario

€ 65

€ 45

€ 10/12

325156 Acciaio new 325132 Acciaio new 276205 1W
325163 2.4W new













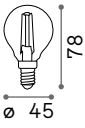

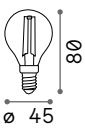

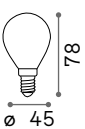

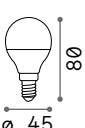

Lampadine* e accessori

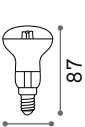

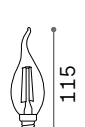
* Per le lampadine al prezzo indicato non sono applicabili ulteriori promozioni.

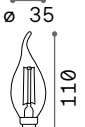
Lampadine E14

		Lamp socket	Power	Flux	CCT	CRI	Dimmable	Life	Min Qty.	Code	€
		E14	4 W	480 lm	3000 K	80		25.000 h	10	101200	2,00
		E14	4 W	380 lm	3000 K	80	TRIAC	15.000 h	10	188935	2,50
		E14	4 W	520 lm	4000 K	80		25.000 h	10	153926	2,00
		E14	4 W	420 lm	3000 K	90		25.000 h	10	271620	2,00
		E14	4 W	300 lm	2200 K	80		15.000 h	10	151656	2,00
		E14	4 W	420 lm	3000 K	80		25.000 h	10	101217	2,00
		E14	3,7 W	340 lm	3000 K	80	TRIAC	25.000 h	10	289229	2,50
		E14	4 W	470 lm	4000 K	80		25.000 h	10	253411	2,00
		E14	4 W	340 lm	3000 K	90		25.000 h	10	289212	2,00
		E14	6 W	550 lm	3000 K	80		25.000 h	10	151731	2,00
		E14	6 W	580 lm	4000 K	80		25.000 h	10	151946	2,00
		E14	3,5 W	370 lm	3000 K	80		25.000 h	10	101262	2,00
		E14	4 W	300 lm	3000 K	80		25.000 h	10	101255	2,50
		Lamp socket	Power	Flux	CCT	CRI	Dimmable	Life	Min Qty.	Code	€
		E14	4 W	430 lm	3000 K	80		25.000 h	10	101248	2,00
		E14	4 W	420 lm	3000 K	80	TRIAC	15.000 h	10	188911	2,50
		E14	4 W	460 lm	4000 K	80		25.000 h	10	153940	2,00
		E14	4 W	400 lm	2200 K	80		15.000 h	10	151663	2,00
		E14	4 W	380 lm	3000 K	80		25.000 h	10	151793	2,00

Lampadine E14

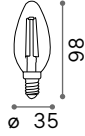

Lamp socket	Power	Flux	CCT	CRI	Dimmable	Life	Min Qty.	Code	€
E14	4W	450 lm	2700 K	80		25.000 h	10	270944	2,00
E14	4W	470 lm	3000 K	80		25.000 h	10	101224	2,00
E14	4W	430 lm	3000 K	90		25.000 h	10	271644	2,00
E14	3,7W	320 lm	3000 K	80	TRIAC	15.000 h	10	188928	2,50
E14	4W	490 lm	4000 K	80		25.000 h	10	153933	2,00

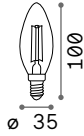

E14	4W	370 lm	2200 K	80		15.000 h	10	151649	2,00
-----	----	--------	--------	----	--	----------	----	--------	------

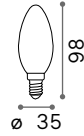

E14	4W	370 lm	3000 K	80		25.000 h	10	101231	2,00
-----	----	--------	--------	----	--	----------	----	--------	------

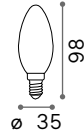

E14	4W	430 lm	3000 K	80		15.000 h	10	326610	2,00
-----	----	--------	--------	----	--	----------	----	--------	------

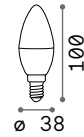

E14	6W	540 lm	3000 K	80		25.000 h	10	151748	2,00
E14	6W	560 lm	4000 K	80		25.000 h	10	151953	2,00



Plastic 151731



Glass 101217



Glass 151793











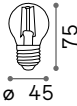



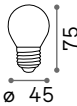

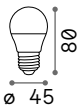
Plastic 151748



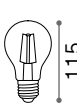

Glass satin 326610

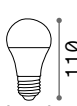
Lampadine E27

		Lamp socket	Power	Flux	CCT	CRI	Dimmable	Life	Min Qty.	Code	€
		E27	4 W	490 lm	2700 K	80		25.000 h	10	271637	2,00
		E27	4 W	430 lm	3000 K	80		25.000 h	10	101279	2,00
		E27	3,9 W	340 lm	3000 K	80	TRIAC	15.000 h	10	188942	2,50
		E27	4 W	490 lm	4000 K	80		25.000 h	10	153957	2,00
		E27	4 W	380 lm	2200 K	80		15.000 h	10	151861	2,50
		E27	4 W	340 lm	3000 K	80		25.000 h	10	101286	2,00
		E27	6 W	550 lm	3000 K	80		25.000 h	10	151755	2,00
		E27	6 W	580 lm	4000 K	80		25.000 h	10	151960	2,00
		E27	4 W	480 lm	3000 K	80		25.000 h	10	101293	2,00
		E27	4,3 W	520 lm	4000 K	80		25.000 h	10	253428	2,00
		E27	8 W	930 lm	2700 K	80		25.000 h	10	270951	3,50
		E27	8 W	910 lm	3000 K	80		25.000 h	10	119571	3,50
		E27	8 W	680 lm	3000 K	80	TRIAC	15.000 h	10	188973	5,00
		E27	8,3 W	980 lm	4000 K	80		25.000 h	10	153964	3,50
		E27	8 W	880 lm	3000 K	90		25.000 h	10	271613	3,50
		E27	10 W	1300 lm	3000 K	80		25.000 h	10	256528	4,50
		E27	10 W	1380 lm	4000 K	80		25.000 h	10	270920	4,50
		E27	10 W	1150 lm	2700 K	90		25.000 h	10	342870	4,50 new
		E27	4 W	530 lm	3000 K	80		25.000 h	10	335261	2,50 new
		E27	4 W	370 lm	2200 K	80		15.000 h	10	151687	2,50
		E27	8 W	900 lm	3000 K	80		25.000 h	10	123899	3,50
		E27	7,8 W	860 lm	3000 K	80	TRIAC	25.000 h	10	252209	5,00
		E27	8 W	1030 lm	4000 K	80		25.000 h	10	253459	3,50
		E27	9 W	970 lm	3000 K	80		25.000 h	10	151762	2,00
		E27	9 W	1020 lm	4000 K	80		25.000 h	10	151991	2,00

Lampadine E27

	Lamp socket	Power	Flux	CCT	CRI	Dimmable	Life	Min Qty.	Code	€
	E27	8 W	900 lm	3000 K	80		25.000 h	10	305622	5,00
	E27	10 W	1150 lm	3000 K	80		25.000 h	10	305639	4,50
	E27	8 W	770 lm	3000 K	80		25.000 h	10	123882	3,50
	E27	14 W	1250 lm	2700 K	90		25.000 h		345857	15,50 <i>new</i>
	E27	14 W	1500 lm	3000 K	90		25.000 h		337135	15,50 <i>new</i>
	E27	14 W	1550 lm	4000 K	90		25.000 h		345864	15,50 <i>new</i>



Glass 101286

Plastic 151755











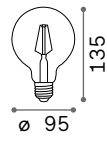

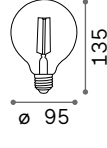

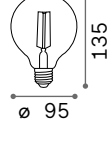
Glass 123899

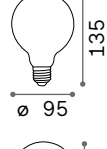
Plastic 151762

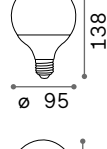
Glass 335261

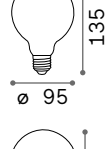
Satin 305622

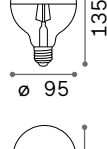
Lampadine E27

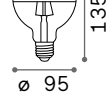
		Lamp socket	Power	Flux	CCT	CRI	Dimmable	Life	Min Qty.	Code	€
		E27	8 W	1050 lm	3000 K	80		25.000 h	10	101323	4,50
		E27	8 W	860 lm	3000 K	90		25.000 h	10	271606	4,50
		E27	8 W	680 lm	3000 K	80	TRIAC	15.000 h	10	188966	7,00
		E27	8 W	1120 lm	4000 K	80		25.000 h	10	153971	4,50
		E27	4 W	550 lm	3000 K	80		25.000 h	10	345840	6,00 <i>new</i>
		E27	4 W	500 lm	2200 K	80		15.000 h	10	151717	8,00
		E27	3,8 W	330 lm	2200 K	80	TRIAC	15.000 h	10	223933	8,00
		E27	8 W	950 lm	3000 K	80		25.000 h	10	101330	4,50
		E27	7,8 W	860 lm	3000 K	80	TRIAC	25.000 h	10	252186	7,00
		E27	8 W	1050 lm	4000 K	80		25.000 h	10	253442	4,50
		E27	14 W	1630 lm	3000 K	80		25.000 h	10	151779	4,00
		E27	14 W	1820 lm	4000 K	80		25.000 h	10	151977	4,00
		E27	8 W	900 lm	3000 K	80	TRIAC	15.000 h	10	277790	7,00
		E27	7,9 W	1050 lm	3000 K	80		25.000 h	10	157597	7,00
		E27	8 W	900 lm	3000 K	80		25.000 h	10	135526	4,50



Glass 101323



Glass 345840



Plastic 101330



Plastic 151779



Glass satin 77790



Glass satin 135526

Lampadine E27



Lamp socket	Power	Flux	CCT	CRI	Dimmable	Life	Min Qty.	Code	€
E27	8 W	1050lm	3000 K	80		25.000 h	10	101347	6,00
E27	8,2 W	860 lm	3000 K	90		25.000 h	10	271590	6,00
E27	8,2 W	680 lm	3000 K	80	TRIAC	15.000 h	10	188959	7,00
E27	8 W	1070 lm	4000 K	80		25.000 h	10	153988	6,00
E27	4 W	480 lm	2200 K	80		15.000 h	10	151724	6,00
E27	3,8 W	330 lm	2200 K	80	TRIAC	15.000 h	10	223926	7,00
E27	8 W	900 lm	2700 K	90		25.000 h	10	342863	6,00 new
E27	8 W	950 lm	3000 K	80		25.000 h	10	101354	6,00
E27	8 W	1030 lm	4000 K	80		25.000 h	10	253435	6,00
E27	18 W	2210 lm	3000 K	80		25.000 h	10	151786	6,00
E27	18 W	2300 lm	4000 K	80		25.000 h	10	152004	6,00
E27	8 W	900 lm	3000 K	80	TRIAC	15.000 h	10	277813	9,50
E27	7,8 W	1050 lm	3000 K	80		25.000 h	10	157580	9,50



Glass 101347



Glass 101354



Plastic 151786











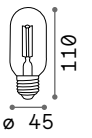

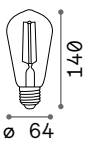

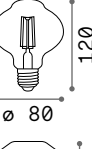
Glass satin 277813

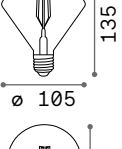

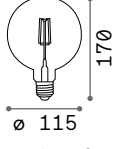
Glass satin 157580

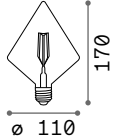
Lampadine E27

	Lamp socket	Power	Flux	CCT	CRI	Dimmable	Life	Min Qty.	Code	€
		E27	4 W	330 lm	2200 K	80	15.000 h	10	151700	4,00
		E27	4 W	440 lm	2200 K	80	15.000 h	10	151694	4,00
		E27	3,8 W	330 lm	2200 K	80	TRIAC 15.000 h	10	223919	5,00
		E27	5,1 W	360 lm	1800 K	80	15.000 h	10	201283	5,00
		E27	5,5 W	360 lm	1800 K	80	15.000 h	10	201269	9,50
		E27	4 W	360 lm	1800 K	80	15.000 h	10	201290	10,00
		E27	5,4 W	360 lm	1800 K	80	15.000 h	10	201276	10,00



151700

151694







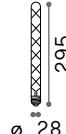
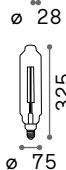

201283

201269

201290

201276

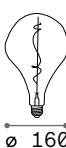
Lampadine E27

	Lamp socket	Power	Flux	CCT	CRI	Dimmable	Life	Min Qty.	Code	€
										
	E27	7,5 W	600 lm	1800 K	80		15.000 h	10	201252	11,00
	E27	6 W	320 lm	1800 K	80		15.000 h	1	130170	33,00
	E27	4 W	320 lm	1800 K	80		15.000 h	1	129877	33,00
	E27	3,8 W	330 lm	2200 K	80	TRIAC	15.000 h	1	223940	33,00
	E27	4,1 W	400 lm	2200 K	80		25.000 h	1	130187	25,00
	E27	3,9 W	330 lm	2200 K	80	TRIAC	15.000 h	1	223834	30,00
	E27	4,1 W	360 lm	2200 K	80		25.000 h	1	237251	22,50
	E27	8 W	700 lm	2200 K	80		25.000 h	1	130163	25,00
										



201252

130170

129877

130187

237251

130163



Nikita new

Lampadina con ampolla in vetro trasparente, sfumato opale sulla parte superiore. Unico filamento lineare centrale. Colore vetro: bianco, fumé.

LED Lampadine LED E27.
CCT: 2200 K, CRI: ≥ 90



345826



345819



0,237 Kg / 0,0099 m³
LED 3W / 230lm / 100lm
€ 30

345802 Bianco new 345826 Bianco new
333915 Fumè new 345819 Fumè new



0,160 Kg / 0,0028 m³
LED 3W / 180lm / 80lm
€ 30

345826 Bianco new 345819 Fumè new



0,280 Kg / 0,0091 m³
LED 3W / 180lm / 80lm
€ 30

333922 Bianco new
345833 Fumè new

Lampadine G4

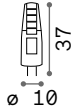
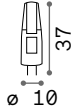

Lamp socket	Power	Flux	CCT	CRI	Dimmable	Life	Min Qty.	Code	€
G4	1,5 W	160 lm	3000 K	80		15.000 h	20	188980	4,50
G4	2 W	200 lm	3000 K	80		20.000 h	20	222257	4,00
G4	2 W	200 lm	3000 K	80	Phase-cut	20.000 h	20	266282	5,00

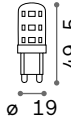
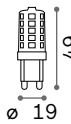
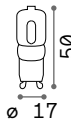
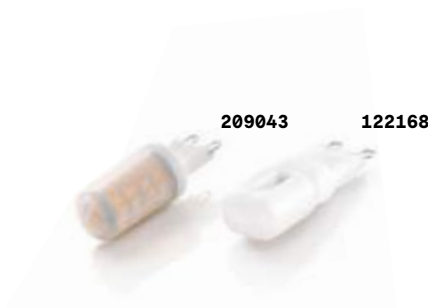

Lampadine G9



Lamp socket	Power	Flux	CCT	CRI	Dimmable	Life	Min Qty.	Code	€
G9	2,5 W	170 lm	3000 K	80		25.000 h	20	122168	3,50
G9	2,5 W	180 lm	4000 K	80		25.000 h	20	253381	3,50
G9	3 W	350 lm	2700 K	80		15.000 h	20	270968	3,50
G9	3 W	370 lm	3000 K	80		15.000 h	20	209043	3,50
G9	3 W	350 lm	3000 K	80	TRIAC	25.000 h	20	288215	5,00
G9	3 W	390 lm	4000 K	80		15.000 h	20	209036	3,50
G9	3,5 W	310 lm	3000 K	90		15.000 h	20	288208	3,50
G9	4 W	470 lm	2700 K	90		15.000 h	20	342887	6,00 new
G9	4 W	510 lm	3000 K	80		15.000 h	20	305486	6,00
G9	3,5 W	420 lm	3000 K	80	TRIAC	15.000 h	20	305431	8,50
G9	4 W	530 lm	4000 K	80		15.000 h	20	307879	6,00
G9	3,5 W	440 lm	4000 K	80	TRIAC	15.000 h	20	307886	8,50



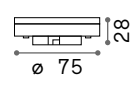

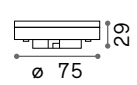
Lampadine GX53





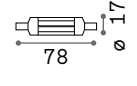

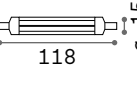

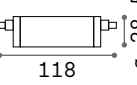

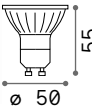

		Lamp socket	Power	Flux	CCT	CRI	Dimmable	Life	Min Qty.	Code	€
		GX53	7W	730 lm	3000 K	80		25.000 h	10	101385	5,00
		GX53	7W	760 lm	4000 K	80		25.000 h	10	253404	5,00
		GX53	9W	910 lm	3000 K	80		25.000 h	10	123936	5,00
		GX53	9W	890 lm	3000 K	80	TRIAC	25.000 h	10	252551	9,00
		GX53	9W	1000 lm	4000 K	80		25.000 h	10	154008	5,00
		GX53	9W	900 lm	4000 K	80	TRIAC	25.000 h	10	252568	9,00
		GX53	9W	880 lm	2700 K	90		25.000 h	10	342900	5,00 new
		GX53	9W	940 lm	3000 K	90		25.000 h	10	288383	5,00

Lampadine R7s

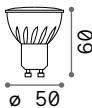

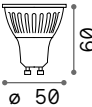
		Lamp socket	Power	Flux	CCT	CRI	Dimmable	Life	Min Qty.	Code	€
		R7s	6,9W	560 lm	3000 K	80		20.000 h	10	189109	13,00
		R7s	5,9W	450 lm	3000 K	80	TRIAC	20.000 h	10	266770	15,00
		R7s	6,9W	580 lm	4000 K	80		20.000 h	10	272375	13,00
		R7s	5,9W	480 lm	4000 K	80	TRIAC	20.000 h	10	272382	15,00
		R7s	12,9W	760 lm	3000 K	80		20.000 h	10	189093	17,00
		R7s	7,9W	580 lm	3000 K	80	TRIAC	20.000 h	10	266763	18,00
		R7s	12,9W	830 lm	4000 K	80		20.000 h	10	253480	17,00
		R7s	7,9W	640 lm	4000 K	80	TRIAC	20.000 h	10	266756	18,00
		R7s	13,5W	1700 lm	3000 K	80		15.000 h	10	307862	12,50
		R7s	14 W	1600 lm	3000 K	80	TRIAC	15.000 h	10	307855	13,50
		R7s	13,5W	1700 lm	4000 K	80		15.000 h	10	296869	12,50
		R7s	14 W	1650 lm	4000 K	80	TRIAC	15.000 h	10	296876	13,50

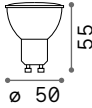
Lampadine GU10

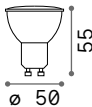
	Lamp socket	Power	Flux	CCT	CRI	Beam	Dimm.	Life	Min Qty.	Code	€
		GU10	4 W	340 lm	3000 K	90	62°	25.000 h	10	339771	3,00 new
		GU10	5 W	430 lm	3000 K	90	50°	25.000 h	10	266251	4,50
		GU10	5 W	430 lm	4000 K	90	50°	25.000 h	10	253497	3,00
		GU10	5 W	450 lm	4000 K	90	50°	25.000 h	10	285566	4,50
		GU10	7 W	540 lm	3000 K	90	50°	25.000 h	10	123943	3,50
		GU10	7 W	460 lm	3000 K	90	50°	25.000 h	10	288239	5,00
		GU10	7 W	620 lm	3000 K	90	108°	25.000 h	10	101378	3,50
		GU10	7 W	650 lm	4000 K	90	108°	25.000 h	10	117652	3,50
		GU10	8 W	580 lm	3000 K	90	56°	25.000 h	10	189062	3,50
		GU10	8 W	620 lm	4000 K	90	56°	25.000 h	10	270975	3,50
		GU10	5 W	380 lm	2700 K	95	50°	25.000 h	10	307619	3,00
		GU10	5 W	410 lm	3000 K	90	50°	25.000 h	10	108292	3,00
		GU10	7 W	540 lm	4000 K	90	50°	25.000 h	10	224367	3,50
		GU10	7 W	600 lm	2700 K	95	108°	25.000 h	10	307626	3,50



Lampadine GU10

	Lamp socket	Power	Flux	CCT	CRI	Beam	Dimm.	Life	Min Qty.	Code	€
	GU10	12 W	930 lm	3000 K	90	20°		25.000 h	10	327037	13,50 new
	GU10	12 W	900 lm	3000 K	90	22°	TRIAC	25.000 h	10	326290	15,00 new
	GU10	12 W	1190 lm	4000 K	90	20°		25.000 h	10	327051	14,00 new
	GU10	12 W	980 lm	2700 K	90	38°		25.000 h	10	342894	14,00 new
	GU10	12 W	1120 lm	3000 K	90	40°		25.000 h	10	327044	13,50 new
	GU10	12 W	1000 lm	3000 K	90	40°	TRIAC	25.000 h	10	327075	18,00 new
	GU10	12 W	1120 lm	4000 K	90	40°		25.000 h	10	327068	14,00 new
	GU10	10 W	750 lm	3000 K	80	22°		15.000 h	10	189031	15,00
	GU10	10 W	720 lm	3000 K	80	22°	TRIAC	15.000 h	10	288543	18,00
	GU10	10 W	780 lm	4000 K	80	22°		15.000 h	10	253398	15,00



242040



183794



189031

Kit emergency

Kit luce d'emergenza per moduli LED. Include inverter e batteria. Autonomia da due a tre ore con un tempo di ricarica rispettivamente di 12 e 24 ore. Funzionamento in sola emergenza o in luce continua (luce continua in abbinamento con alimentatori elettronici e alimentatori elettronici dimmerabili). Protetto in classe II.

€ 135

221595 Bianco



INVERTER

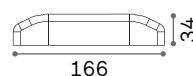

IP20

0,185 Kg / 0,0009 m³

⌀ 52 mm

GROUP BATTERY

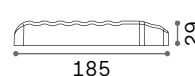

0,305 Kg / 0,0010 m³

⌀ 65 mm

Per ulteriori informazioni, si prega di contattare l'ufficio tecnico.

Rosoni

Rosoni magnetici

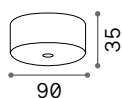

1 cavo

244235 € 13,00	244259 € 13,00	249315 € 15,00	249308 € 15,00	244242 € 13,00

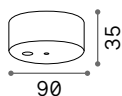

1 cavo

311265 € 14,00	328683 € 14,00	328706 € 16,00	328690 € 16,00	311272 € 14,00

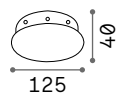

6 cavi

303390 € 14,50	303406 € 14,50	307091 € 21,00	307084 € 21,00	307077 € 14,50

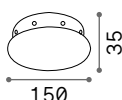

8 cavi

272429 € 16,50	272436 € 16,50	272443 € 23,50	272450 € 23,50	272467 € 16,50

Rosoni standard

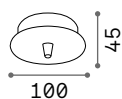

1 cavo

122823 € 10,00	122830 € 10,00	249278 € 11,00	249261 € 11,00	123295 € 10,00

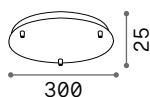

3 cavi

285580 € 33,00	285597 € 33,00	285627 € 50,00	285610 € 50,00	285603 € 33,00

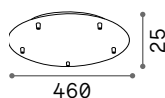

5 cavi

285634 € 60,00	285641 € 60,00	285672 € 80,00	285665 € 80,00	285658 € 60,00

Rosoni

Rosoni incasso

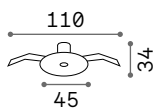

1 cavo

				
301594 € 5,00	307107 € 5,00	307138 € 5,00	307121 € 5,00	307114 € 5,00

Rosoni lineari all in

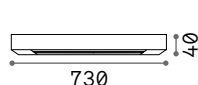

4 cavi

				
304038 € 60,00	328713 € 60,00	328744 € 70,00	328737 € 70,00	328720 € 60,00

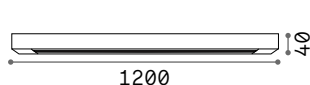

6 cavi

				
328751 € 90,00	304045 € 90,00	328782 € 110,00	328775 € 110,00	328768 € 90,00

Rosoni lineari standard

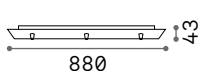

3 cavi

				
122854 € 33,00	122861 € 33,00	249292 € 55,00	249285 € 55,00	123301 € 33,00

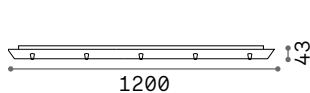

5 cavi

				
285689 € 60,00	285696 € 60,00	285726 € 75,00	285719 € 75,00	285702 € 60,00

Accessori

Portalampada

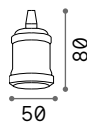

				
249186 € 13,00	249193 € 13,00	249223 € 13,00	249216 € 13,00	249209 € 13,00

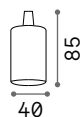

				
242569 € 5,00	249230 € 5,00	249254 € 5,00	249247 € 5,00	242576 € 5,00

Cavi

2x0,75 mm²
FEP T180°
PVC T90°
*only PVC

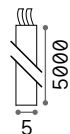

				
301624 € 11,00	301662* € 15,00	301655 € 12,00	301648 € 12,00	301631 € 11,00

2x0,75 mm²
FEP T180°
PVC T90°
*only PVC

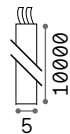

				
301679 € 22,00	301716* € 30,00	301709 € 24,00	301693 € 24,00	301686 € 22,00

2x0,75 mm²
FEP T180°
PVC T90°
*only PVC

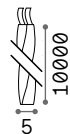

				
303062 € 30,00	306421 € 30,00	303093 € 32,00	303086 € 32,00	303079 € 30,00

Supporti



				
143200 € 5,00	143224 € 5,00	249339 € 5,00	249322 € 5,00	143217 € 5,00



				
285887 € 5,00	285894 € 5,00	285924 € 5,00	285917 € 5,00	285900 € 5,00













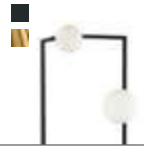



















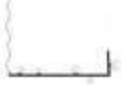









Topico

Pag 534























































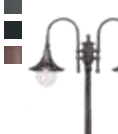























Indice famiglie

						
Angolo	 334	 476	 500			
						
Arizona	 156	 156	 278	 278	 278	
						
Axel	 478	 526	Binomio	 337	 337	 429
						
Birds	 105	 327	 421	 473	 497	
						
Bubble	 812	 854				
						
Candy	 158	 158	 280	 469		
						
Cantina	 137	 426				

Indice famiglie

Interno, esterno

						
Carlton	 203	 203	 355	 355	 439	
						
Carta	 170	 170	 170	 170	 282	 282
						
	 385	 385	 468	 468	 519	 519
						
Chalet	 234	 234	 234	 444	 484	
						
Cima	 857	 910				
						
Clio	 806	 806	 856	 908	 908	
						
Corte	 215	 215	 215	 441		
						
Cotton	 159	 159	 159	 281	 281	 281



Craft 091 374 510



Cylinder 190 532



Dafne 857 857 911



Desk 090 090 090 374



Diamond 102 102 102 466

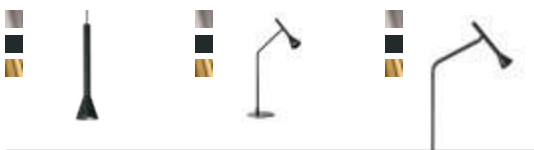

Diesis 126 459 511





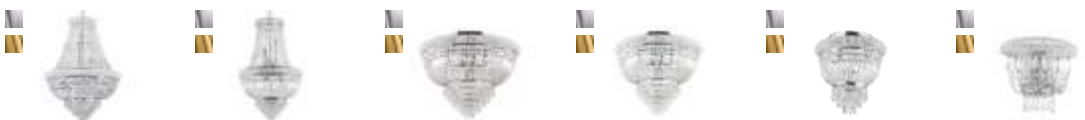























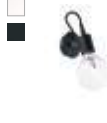





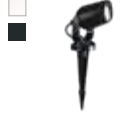

































































Driftwood 235 235 484 526 526



Dubai 208 208 353 353 353 439

Indice famiglie

Interno, esterno

Dynamite				Easy		
						
						
	096	096	312		458	511
Edison						
						
						
	120	416				
Elio						
						
						
	820	926				
Equinoxe						
						
						
	108	108	108	108	108	108
						
						
						
	425	499				
Essence						
						
						
	088	390	390			
Etere						
						
						
	826	904				
Filo						
						
						
	084	084	392	392	456	502
Firenze						
						
						
	230	230	444	485	535	



Florian

220 220 220 442



Frame

076 076 076 247 247 247

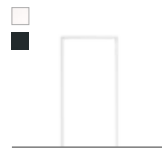

501



Frida

120 419



Futura

460 514



Gas

823 891



Gemini

060 060 060 060 272 272



272



Gioconda

224 224 224 443



Glory

155 155 155 276 276 276

Indice famiglie

Interno, esterno



Gun

810

834

834



Harem

233

233

446



Igor

101

420



Kepler

111

111

422



King

200

200

346

346

346



Koala

920

920

920

920



Lana

153

298

298



Linus

375

624

Litio

821

926



Lika

311 784 784 784 784 784



784 784 792



Lingotto

100 100 100 335 335 335



477 477



London

479 479 529



Look

078 078 300 300 300 300



































































381 506 698 Lumiere 178































































178 178 341 341 465 496

Indice famiglie





















Interno, esterno

						
Luna	 804	 804	 878	 878	 878	
						
Mapa	 168	 168	 168	 168	 168	 168
						
	 282	 384	 384	 384	 384	 470
						
	 470	 470	 470			
						
Maracas	 330	 330	 424			
						
Martinez	 202	 354				
						
Mix Up	 130	 290	 508			
						
Mouse	 316	 412	 412	 694		

						
Negresco	 218	 218	 442	Newton	 426	 516
						
Ninfea	 339	 339	 431	 431	 471	
						
Nodi	 175	 175	 322			
						
Nordik	 189	 189	 436	 480	 532	
						
Oak	 082	 310				
						
Oby	 317	 317	 415	 415		
						
Opera	 198	 198	 198	 440		
						
	 486	 534				

Indice famiglie

Interno, esterno

						
						
Oracle Slim	 068	 068	 068	 068	 074	 074
						
						
	 074	 242	 242	 242		
						
Ovalino	 157	 157	 284	 284	 382	
						
						
Oz	 064	 064	 244	 362	 452	
						
O-Zone	 818	 916		Pan	 191	 430
						
						
Pashà	 205	 205	 205			
						
						
	 438	 345	 345	 345		
						
						
Pegaso	 212	 212	 212	 441	 489	 489



Penta 340 340 431



Perlage 106 106 106 106 106 324

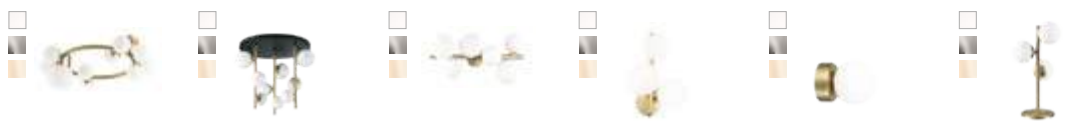

324 324 324 423 423 473



473 498



Ping Pong 336 336 428 428 472 505



Pure 864 864



Queen 488 488 488 534



Rain 201 352 352

Indice famiglie

Interno, esterno



Roma

438

486

344

344

344

344



Rudy

318

318

413

413



Set Up

192 - 194 - 196

192 - 194 - 196

192 - 194 - 196



292 - 294 - 296

292 - 294 - 296

292 - 294 - 296



434

434

482

482

530



192

292

434

482

530



Set Up Slim

194

294

Set Up Ultra Slim

196

296



Sirio

841

886

886

924



Sky

083

301

301

301

381



Smarties

154

154

154

277

277

277



277

385

469

469

469



Snow

805

855



Sole

802

802

802

802

877

877



877

877

Spike

308

697



Spot

316

412

412

694



Strauss

225

225

225

443

Indice famiglie

Interno, esterno



Style ■ 826 ■ 826 ■ 884



Swan ■ 199 ■ 199 ■ 440



Terra ■ 822 ■ 822 ■ 925 ■ 925

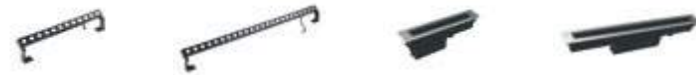

Thor ■ 914 ■ 914 ■ 932 ■ 932



Toffee ■ 837 ■ 866 ■ 866 ■ 866 ■ 866 ■ 866



Topico ■ 148 ■ 283 ■ 283



Triumph ■ 098 ■ 326 ■ 424 ■ 424



Tronco ■ 828 ■ 898 ■ 898 ■ 898



Wally

463

517



Winery

315

416



Yoko

089

457

503



Indice per codice

deal lux



Indice per codice

SKU	Pag	020846	444	035666	143	059259	489	081526	216	092447	851
		020853	485	035680	143	059266	489	082059	175	092836	420
000206	470	020877	535	035697	143	059679	152	082073	175	092911	206
000657	344	022222	350	035710	143	059808	384	082158	205	092942	101
002880	535	022239	350	035727	153	059815	384	082172	205	093086	438
003528	516	023021	139	035826	199	059822	384	082196	205	093093	344
004716	828	023038	139	035840	199	059839	282	082240	852	093659	134
004723	898	024097	910	035864	440	060491	443	082257	205	093697	134
004730	898	024134	857	035949	437	060507	224	082264	438	093963	284
005386	396	025438	190	035956	437	060514	224	082288	438	093994	231
005881	215	026473	386	038025	382	060620	382	082783	351	094007	231
005898	215	026480	386	041742	522	061115	518	082790	351	094014	284
005911	232	026558	387	041827	209	061122	518	083070	794	094137	172
007021	396	026787	140	043562	168	061139	518	083087	794	094182	381
007045	396	026954	898	044255	226	061160	463	083117	794	094229	172
007960	298	026961	898	044279	270	061191	463	083124	794	094236	172
007977	298	026978	828	044286	270	061450	830	083131	794	094649	351
007984	298	026985	898	044293	270	061467	830	083148	794	094663	351
007991	298	026992	898	044422	227	061474	830	083179	794	094786	232
008363	201	027005	828	044453	227	061580	847	083186	794	095226	156
008370	352	027081	388	044491	487	061597	847	083193	794	095998	381
008455	352	027098	388	044590	475	066448	212	083223	794	096018	381
008608	299	027104	388	044606	475	066868	847	083230	794	096476	820
008615	299	027852	426	044767	207	068138	298	083247	794	096483	820
008622	299	027876	426	044774	207	068145	298	083254	796	096667	853
009087	168	028460	441	044910	443	068169	153	086736	158	096674	853
009131	470	030326	140	044927	224	068268	440	086743	158	096681	853
009148	168	030784	350	044934	224	068275	534	086781	280	096698	853
009155	470	031361	369	045030	464	068299	198	086804	469	096704	853
009223	277	031460	401	045047	464	068305	486	087368	447	096711	853
009537	367	031477	401	045115	161	073187	346	087375	447	096728	853
009933	368	031743	187	045122	161	073255	346	087757	442	096735	853
009940	368	031750	187	045191	418	073262	346	087764	218	097183	398
009957	368	031996	154	045214	418	073521	412	087771	218	097190	398
010861	275	032009	154	045627	389	073545	412	087818	180	097206	398
012865	230	032016	154	045634	389	073569	412	087863	344	097664	215
012872	230	032023	277	046167	822	073583	316	087870	344	097671	215
012889	485	032030	277	046181	822	073712	322	087979	200	098616	156
012902	444	032047	277	046211	925	074139	157	088013	200	100364	847
013046	447	032078	469	046471	522	074245	141	088020	200	100371	847
013060	447	032122	168	046723	522	074313	141	088266	369	100388	834
013657	464	032139	168	049229	369	074337	141	088273	369	100395	834
014166	369	032368	479	049236	369	074702	474	089805	527	100746	345
014609	528	032375	479	051406	487	074726	474	090481	157	100784	345
014814	385	032382	529	051444	370	075150	220	091006	270	100791	345
015286	516	032825	936	051741	525	075181	220	091013	270	100807	345
016399	426	032832	936	051765	525	075211	445	091129	369	100937	160
016863	186	033013	834	051840	387	075389	346	091136	369	100944	160
017297	396	033020	834	051857	387	075402	346	091518	823	100951	160
017303	396	033037	925	051864	387	075419	346	091525	823	101125	155
017310	396	033044	925	051963	368	077734	488	092188	848	101132	276
017327	397	033532	209	051970	368	077741	488	092195	848	101200	944
017334	397	033662	161	051987	368	077758	488	092201	848	101217	944
017518	370	033679	161	052786	153	077765	534	092218	840	101224	944
018508	275	033952	139	052809	172	077796	351	092225	902	101231	944
018515	840	034546	366	052816	172	077802	351	092300	834	101248	944
018522	840	035574	214	052991	352	077819	351	092317	834	101255	944
019734	155	035581	214	053004	352	080338	347	092324	810	101262	944
019741	155	035604	220	057187	215	080345	347	092355	847	101279	946
019758	276	035611	220	057194	215	080352	347	092393	850	101286	946
019765	276	035628	220	057200	441	080932	351	092409	850	101293	946
020228	823	035635	220	059211	441	081434	270	092416	851	101323	946
020822	230	035642	442	059235	212	081441	270	092423	851	101330	946
020839	230	035659	442	059242	212	081519	216	092430	851	101347	946

101354	946	114170	216	120898	184	129877	946	140933	307	150130	792
101378	956	114187	216	120904	184	129921	210	141794	78	150284	798
101385	955	114279	209	121130	396	130163	946	141800	78	150291	792
101491	857	114293	844	121147	396	130170	946	141817	78	150307	792
101514	911	114347	902	121154	396	130187	946	141855	78	150420	310
101552	857	114620	486	121161	396	131924	162	142241	403	150437	310
101606	113	114729	209	121178	396	132365	150	142258	403	150635	82
101613	113	114736	209	121338	396	132389	150	142265	395	151649	944
102047	134	114743	209	121352	401	133393	323	142272	395	151656	944
103174	185	115061	886	121406	527	134826	235	142289	395	151663	944
103204	437	115078	886	121437	527	134833	235	142296	395	151687	946
103983	186	115085	886	121963	831	134840	235	142302	842	151694	946
104928	78	115092	886	122014	941	134871	136	142579	403	151700	946
104935	78	115108	886	122021	941	135205	903	142586	403	151717	946
104942	78	115115	886	122045	858	135250	812	142692	400	151724	946
105710	383	115290	844	122083	120	135526	946	142708	400	151731	944
105727	383	115306	844	122106	120	135755	901	142906	86	151748	944
106205	925	115313	844	122168	954	135762	901	142913	86	151755	946
108094	462	115320	844	122557	185	135908	903	142999	901	151762	946
108117	462	115337	844	122564	185	135991	802	143200	960	151779	946
108292	956	115344	844	122663	810	136004	802	143217	960	151786	946
109138	898	115351	846	122687	810	136011	802	143224	960	151793	944
109145	898	115368	846	122823	958	136028	893	144238	806	151861	946
110233	529	115375	846	122830	958	136035	893	144245	806	151946	944
110240	529	115382	858	122854	958	136042	893	144252	806	151953	944
110356	524	115412	927	122861	958	136059	893	144276	831	151960	946
110363	524	115429	927	123080	831	136073	806	144283	830	151977	946
110417	122	115481	412	123295	958	136318	177	144917	397	151991	946
110424	122	115498	234	123301	958	136325	177	145020	908	152004	946
110431	122	115504	234	123745	849	137391	832	145068	908	153162	890
110448	479	115511	444	123769	849	137681	133	145228	856	153179	890
110455	479	115580	797	123776	849	137827	527	145303	821	153193	890
110462	122	115597	797	123783	849	138237	90	145310	926	153209	890
110530	479	115610	797	123882	946	138251	374	145327	821	153926	944
110554	479	115962	446	123899	946	138305	172	145334	926	153933	944
110745	142	115979	233	123936	955	138374	416	145341	821	153940	944
110752	142	116006	233	123943	956	138510	901	145358	926	153957	946
111452	532	116112	275	123974	776	138596	264	146775	856	153964	946
111841	180	116228	206	123981	776	138602	264	146782	856	153971	946
111858	180	116235	206	123998	776	138619	264	146799	856	153988	946
111865	180	116457	121	124001	776	138633	266	147642	454	154008	955
111872	214	116464	121	124018	776	138640	266	147659	454	155142	315
111896	214	116716	908	124025	776	138657	266	147666	776	155227	315
111902	172	117652	956	124070	644	138978	794	147673	776	155722	798
111919	172	117737	203	124087	644	139012	792	147680	776	155791	310
111957	112	117867	366	124117	644	139029	792	147765	832	155869	310
112268	112	117881	936	125503	343	139098	133	147772	832	155968	115
112305	184	118659	828	125510	343	139425	120	147796	832	156026	115
112312	184	118666	831	125831	136	139432	120	147819	832	156033	115
112336	184	119427	417	126883	381	139470	891	148151	116	156682	86
112343	184	119465	417	126890	381	140179	299	148175	116	156699	86
112626	426	119502	417	126906	83	140186	299	148502	116	156705	412
112695	426	119571	946	126913	83	140193	299	148847	806	156712	316
112701	137	120201	926	128207	484	140230	162	148854	806	156729	412
112732	137	120218	926	129082	122	140599	443	148861	806	156736	412
113302	120	120249	937	129099	122	140605	225	148878	806	156743	412
113319	120	120287	938	129433	833	140612	225	148908	416	156774	316
113753	844	120317	937	129457	833	140629	225	148939	526	156781	316
113760	844	120324	937	129464	824	140711	166	149585	172	157580	946
113791	845	120362	938	129471	824	140728	166	149592	172	157597	946
113975	234	120386	937	129488	824	140759	166	149622	323	157856	888
113982	796	120423	857	129570	484	140841	307	149738	842	158242	436
113999	796	120430	857	129600	235	140872	307	149745	842	158723	78
114019	796	120454	911	129709	210	140902	307	150116	792	158815	95

Indice per codice

SKU	Pag	165004	345	179308	378	189727	670	192505	626	198149	335
		165011	198	179315	378	189734	670	192550	626	198156	335
158822	847	166247	203	179322	378	189741	670	192567	626	198620	900
158860	95	166285	354	179643	427	189758	670	192604	626	198637	900
158891	906	166360	202	179681	389	189765	670	192628	626	198644	900
158907	854	166889	217	179858	176	189772	670	192642	626	199375	229
159010	328	167121	414	180298	416	189789	670	192666	626	199382	229
159256	190	167152	414	180304	416	189796	670	192673	626	199405	229
159423	389	167244	222	180922	235	189802	670	192697	626	199412	229
159508	389	167251	222	180946	526	189819	670	192703	626	200118	108
159522	389	167268	222	180953	880	189826	670	192710	626	200125	108
159812	190	167398	222	182179	198	189833	670	192741	626	200132	425
159836	813	167404	222	186955	906	189840	670	192758	626	200149	425
159843	119	167411	222	186979	906	189857	670	193458	770	200194	321
159850	119	167497	116	187006	422	189864	670	193465	770	200200	321
159867	119	168036	811	187327	888	189871	670	193472	770	200217	321
159942	228	168050	811	187365	369	189888	670	193519	770	200231	321
159973	228	168111	811	187662	86	189895	670	193526	770	200248	321
159997	415	168135	811	187877	907	189901	670	193533	770	200255	321
160214	424	168753	219	187884	907	189918	670	193946	463	200330	424
160245	424	168777	219	187891	907	189925	670	193991	463	200354	330
160269	98	168906	227	187976	708	189932	670	194172	86	200361	330
160313	326	168913	439	187983	708	189949	670	194189	86	200484	322
160856	171	168920	355	187990	708	189956	670	194196	86	200491	175
160863	171	168937	355	188003	708	189963	670	194202	86	200996	353
161327	166	169576	708	188010	708	189970	670	194257	708	201016	353
161334	166	169583	708	188027	708	189987	670	194301	708	201023	439
161648	189	169590	708	188058	708	189994	670	194677	129	201252	946
161662	189	169606	708	188065	708	190006	670	194684	129	201269	946
161686	480	169613	708	188072	708	190013	670	194806	78	201276	946
161716	532	169620	708	188089	708	190020	670	195483	876	201283	946
161754	879	169637	708	188096	708	190037	670	195490	876	201290	946
161761	879	169644	708	188102	708	190044	670	195506	876	202396	742
161778	879	169705	708	188119	708	190051	670	195704	364	202921	812
161785	370	169712	708	188126	708	190068	670	195711	364	202945	812
161792	370	169729	708	188195	708	190075	670	195728	364	203072	652
162201	111	169736	708	188911	944	190082	670	195735	364	203089	652
162478	111	169972	708	188928	944	190099	670	195742	364	203102	652
162492	906	169989	708	188935	944	190105	670	195759	364	203126	652
162737	211	170145	708	188942	946	190181	670	195766	364	203171	398
162751	211	170152	708	188959	946	191171	626	195773	364	203188	398
163321	419	170589	78	188966	946	191188	626	196190	274	203195	398
163338	419	170923	369	188973	946	191508	626	196206	274	204581	652
163536	847	172408	829	188980	954	191577	878	196220	274	204598	652
163543	847	172439	904	189031	956	191584	878	196688	415	204611	652
163550	847	172804	343	189062	956	191607	878	196695	415	204635	652
163598	848	172828	343	189093	955	191614	877	196701	317	204888	460
163604	834	173245	90	189109	955	191621	877	196718	317	204895	460
163611	834	173252	374	189536	670	191638	877	196770	124	204949	514
163628	834	174204	151	189574	670	191997	626	196787	124	204956	514
163635	834	174211	151	189581	670	192277	742	197319	110	205281	117
163642	810	174228	151	189598	670	192284	742	197333	110	205298	117
163666	810	174235	151	189604	670	192291	742	197500	231	205304	117
163727	925	174396	188	189611	670	192307	742	197524	231	205311	117
163741	898	174402	188	189628	670	192314	742	197654	187	205977	302
163758	898	174792	411	189635	670	192321	742	197661	187	205984	302
164823	381	174808	411	189642	670	192338	742	197708	441	205991	302
164847	381	174822	411	189659	670	192345	742	197715	212	206004	302
164878	86	174846	411	189666	670	192352	742	197722	212	206011	302
164953	224	174921	329	189673	670	192376	742	197739	212	206028	302
164960	224	174976	329	189680	670	192383	742	197753	489	206035	302
164977	205	177199	533	189697	670	192406	742	198095	144	206042	302
164984	205	177205	533	189703	670	192437	626	198125	100	206196	784
164991	345	179292	378	189710	670	192482	626	198132	335	206202	784

206219	784	213361	893	222769	612	229041	413	235547	97	243924	307
206226	784	213491	439	222820	940	229058	318	236841	834	243931	307
206233	784	213507	355	222837	940	229065	318	236858	834	243948	307
206240	784	213521	203	222882	612	229072	318	236865	810	243986	780
206387	92	213569	354	222899	612	229089	318	236957	93	243993	780
206394	92	213583	202	222912	612	229461	68	236964	93	244013	780
206622	232	214009	876	222929	612	229478	68	237251	946	244181	782
206639	232	214474	156	222936	612	229485	68	237398	182	244198	782
206806	119	214481	156	222943	612	229492	68	237428	182	244204	782
206820	119	214498	278	222950	612	229508	68	237442	182	244235	958
206875	119	214504	278	222967	612	229515	68	237497	182	244242	958
207155	439	214511	278	222974	612	229676	695	237510	182	244259	958
207162	353	214672	380	223001	612	229683	695	237664	118	244549	644
207186	353	214689	380	223018	612	229706	694	237671	118	244556	644
207216	208	214696	380	223025	612	229720	694	237794	204	244563	644
207834	99	215693	437	223032	612	229768	694	237800	204	244570	644
207841	99	215709	437	223049	612	229782	694	237930	410	244587	644
207858	99	215761	268	223056	612	229997	792	238104	135	244594	644
208398	174	215778	268	223124	612	230580	792	238135	135	244624	96
208541	734	215785	268	223148	612	230702	247	238173	135	244648	96
208558	734	215969	208	223155	612	230726	247	238210	135	244662	312
208565	734	216027	734	223162	612	231228	121	238746	183	244808	758
208572	734	216263	734	223179	612	231259	121	238838	183	244822	758
208589	734	216270	626	223186	258	231273	121	238920	183	244846	758
208596	734	216287	626	223193	258	231297	121	238944	432	244853	758
208640	734	216317	734	223209	258	231341	96	238951	432	244884	311
208657	734	216324	734	223216	258	231372	96	238975	432	245041	918
208695	734	216416	626	223223	258	231396	96	239521	436	245072	918
208701	734	216423	626	223230	258	231433	96	239545	436	245089	918
208725	734	217253	742	223247	258	231471	312	239576	436	245096	918
208732	734	219875	188	223742	652	231495	312	239590	436	245102	918
208794	430	220826	626	223759	652	231556	128	239606	436	245331	481
208817	191	221489	129	223766	652	231563	128	240367	264	245348	481
209036	954	221496	129	223834	946	231570	128	240374	266	245393	481
209043	954	221502	826	223919	946	231587	128	241012	175	246390	782
209845	826	221519	826	223926	946	231594	128	241036	175	246451	708
209852	826	221595	957	223933	946	231600	128	241050	322	246468	708
209906	884	222097	74	223940	946	231631	698	241296	353	246499	708
211381	74	222103	74	224275	612	231662	698	241517	146	246505	708
211398	74	222110	74	224367	956	232041	133	241524	146	246512	708
211404	74	222257	954	224541	145	232690	125	241968	624	246529	708
211459	82	222509	662	224930	394	232713	125	241975	624	246536	708
211466	82	222523	662	224954	394	232720	125	241982	624	246543	708
211701	82	222530	662	224985	394	232744	125	241999	624	246550	708
211718	82	222547	662	224992	394	232966	314	242002	624	246567	708
211787	734	222554	662	225005	394	232980	314	242019	375	246574	708
211794	734	222561	662	225029	394	233031	314	242569	960	246581	708
211817	734	222578	662	225364	662	233062	300	242576	960	246598	708
211824	734	222585	662	226026	170	233079	300	242705	708	246604	708
212623	940	222592	662	226033	170	233192	300	243160	410	246611	708
212647	940	222608	662	226040	170	233215	300	243238	708	246628	708
213071	901	222615	662	226187	940	233321	300	243245	708	246796	813
213088	901	222622	662	226194	940	233352	300	243252	708	246819	857
213095	823	222639	662	226200	940	233666	375	243269	708	246826	857
213101	891	222646	662	226217	940	233765	301	243283	708	246833	910
213194	804	222653	662	227580	708	233772	301	243450	307	246840	910
213200	804	222660	662	227597	708	233826	301	243498	353	246857	826
213217	850	222677	662	227672	708	233833	301	243528	208	246864	826
213262	886	222684	662	227689	708	233840	375	243566	353	246871	884
213279	886	222691	662	227825	246	233970	301	243597	208	246888	903
213323	844	222707	662	227832	246	234007	301	243665	626	246895	708
213330	846	222714	662	229010	413	235455	97	243818	794	246901	708
213347	844	222745	612	229027	413	235486	97	243825	794	246918	903
213354	844	222752	612	229034	413	235516	97	243849	794	246925	829

Indice per codice

SKU	Pag	249230	960	252568	955	257792	558	260136	192	266282	954
		249247	960	252971	734	257839	558	260235	192	266497	764
246932	904	249254	960	252988	734	257846	558	260242	192	266503	764
246949	829	249261	958	252995	734	257877	558	260327	434	266510	764
246956	904	249278	958	253008	734	257990	558	260334	434	266527	764
246963	886	249285	958	253015	734	258027	558	260341	434	266534	764
246970	886	249292	958	253381	954	258140	558	260358	434	266541	764
246987	888	249308	958	253398	956	258171	558	260433	482	266558	764
246994	888	249315	958	253404	955	258232	558	260440	482	266565	764
247007	708	249322	960	253411	944	258256	558	260457	192	266572	764
247045	927	249339	960	253428	946	258270	778	260464	192	266589	764
247083	842	249452	908	253435	946	258287	313	260471	192	266596	764
247144	941	249469	908	253442	946	258300	648	260488	192	266602	764
247151	941	249476	908	253459	946	258751	74	260600	402	266657	764
247229	60	249483	908	253480	955	258768	74	260617	402	266671	764
247236	60	249490	908	253497	956	258775	74	260624	402	266688	764
247243	60	249506	908	253558	662	258874	503	260631	402	266701	764
247250	60	249513	908	253589	76	258881	457	260648	402	266725	764
247267	60	249520	908	253596	76	258898	89	260655	402	266732	764
247274	60	249629	708	253664	64	258904	503	260662	402	266756	955
247281	60	249711	782	253671	64	258911	457	260679	402	266763	955
247618	708	249728	782	253688	244	258928	89	260853	558	266770	955
247625	708	249827	799	253695	362	259048	433	260860	558	267128	634
247779	342	249834	799	253886	644	259062	433	261164	276	267135	634
247847	782	250106	405	253893	644	259154	68	261188	276	267142	634
247854	782	250113	405	254272	248	259161	68	261195	176	267159	634
247939	662	250120	405	254289	248	259178	68	261287	922	267203	558
247946	662	250304	172	254319	882	259185	68	261294	922	267210	558
247953	662	250311	172	254388	882	259192	68	261331	914	267227	558
247960	662	250328	172	254944	612	259208	68	261355	914	267234	558
247977	662	250335	172	255019	247	259222	477	261362	914	267241	558
247984	662	250342	172	255514	930	259239	78	261379	914	267258	558
247991	662	250359	172	255521	930	259260	300	263434	84	267692	782
248165	780	250403	678	255651	933	259277	300	263441	84	267777	678
248172	780	250410	678	255668	933	259345	365	263519	284	267784	678
248189	780	250427	678	255682	933	259352	365	263632	146	267791	678
248196	780	250434	678	255781	931	259376	558	263649	146	267807	678
248257	898	250441	678	255804	931	259765	434	263656	146	267869	784
248264	898	250458	678	255934	268	259772	434	263663	84	267876	784
248271	898	250854	858	255941	268	259796	434	263670	84	267883	784
248288	898	250946	845	255996	708	259802	434	263687	84	267890	784
248295	898	250953	892	256030	708	259819	434	263700	84	267906	784
248370	780	250977	892	256047	708	259826	434	264523	152	267913	784
248387	918	251103	100	256061	708	259833	434	264547	152	267920	780
248394	918	251110	100	256078	708	259857	434	265278	463	267937	780
248530	311	251127	477	256085	708	259864	482	265285	463	267944	780
248554	182	251226	891	256092	708	259871	482	265292	517	267951	780
248592	780	251257	891	256115	708	259895	482	265575	390	267968	742
248608	780	251295	891	256122	708	259901	482	265643	390	267975	742
248783	768	251516	808	256146	708	259918	482	265803	279	267982	784
248790	768	251523	808	256528	946	259925	482	265827	279	268002	784
249018	768	251530	808	257235	365	259949	482	265841	279	268071	375
249025	768	251547	808	257242	365	259956	482	265896	558	268088	778
249032	768	251554	808	257617	558	259963	530	265957	68	268095	375
249049	768	251561	808	257624	558	259970	530	265971	242	268101	313
249056	135	251578	808	257631	558	259994	530	265988	242	268118	624
249063	135	251592	808	257648	558	260006	530	265995	242	268149	624
249070	135	252025	795	257655	558	260013	192	266008	242	268156	922
249087	135	252032	795	257662	558	260020	192	266015	242	268163	922
249186	960	252049	795	257686	558	260044	192	266022	242	268170	922
249193	960	252056	795	257709	558	260051	192	266121	558	268187	922
249209	960	252186	946	257716	558	260068	482	266145	558	268194	922
249216	960	252209	946	257730	558	260075	482	266183	558	268200	922
249223	960	252551	955	257747	558	260082	482	266251	956	268217	624

268231	624	270296	248	272375	955	277790	946	283036	558	285184	152
268293	845	270302	248	272382	955	277813	946	283043	558	285191	152
268309	845	270319	248	272429	958	277912	626	283050	700	285207	284
268316	845	270326	248	272436	958	277929	626	283067	700	285214	300
268354	858	270333	248	272443	958	277967	498	283104	558	285238	308
268422	882	270340	248	272450	958	278704	308	283111	558	285283	376
268439	882	270357	248	272467	958	279596	728	283258	700	285290	376
268989	930	270364	248	272474	644	279602	728	283333	459	285306	376
268996	930	270371	248	272481	644	279626	728	283524	700	285313	376
269009	930	270388	248	272498	644	279633	728	283531	700	285320	399
269023	930	270395	248	272504	644	279640	728	283548	700	285337	511
269115	812	270401	248	272511	644	279671	728	283555	700	285344	511
269122	812	270449	652	272528	644	279688	728	283562	700	285351	678
269139	826	270463	652	272535	644	279695	728	283579	700	285368	678
269146	826	270517	652	272542	644	279718	728	283586	700	285375	678
269153	829	270524	652	273167	742	279725	728	283593	700	285382	678
269160	904	270531	652	273174	742	279770	126	283609	700	285399	678
269221	845	270548	652	273631	327	279794	126	283616	700	285405	678
269313	842	270586	248	273648	105	279800	511	283623	700	285412	742
269320	842	270593	248	273655	421	280233	728	283630	700	285429	742
269337	76	270661	247	273662	497	280240	728	283647	700	285436	742
269351	76	270678	247	273679	473	280998	404	283654	700	285443	742
269375	76	270692	626	273693	333	281001	404	283661	700	285450	819
269382	76	270715	248	273709	333	281568	132	283678	700	285467	819
269399	362	270876	626	273914	376	281582	132	283685	700	285474	819
269405	362	270883	626	273945	376	282084	526	283692	700	285481	819
269412	244	270920	946	274508	696	282091	478	283708	700	285498	819
269429	244	270937	626	274515	696	282107	105	283715	700	285504	819
269436	64	270944	944	274768	756	282114	105	283722	700	285511	819
269443	64	270951	946	274775	756	282121	378	283739	700	285528	819
269450	64	270968	954	274782	756	282138	378	283746	700	285535	819
269467	64	270975	956	275178	108	282244	873	283753	700	285566	956
269474	452	271002	248	275215	108	282251	873	283760	700	285580	958
269481	452	271187	640	275369	89	282633	558	283777	700	285597	958
269498	452	271194	640	275376	89	282640	558	283784	423	285603	958
269504	939	271200	640	275543	181	282657	558	283791	106	285610	958
269696	939	271217	640	275567	181	282664	558	283807	106	285627	958
269702	939	271293	147	275581	181	282671	558	283814	106	285634	958
269719	939	271309	147	276182	686	282688	558	283821	106	285641	958
269726	939	271316	147	276205	930	282695	558	283920	678	285658	958
269733	939	271385	106	276243	686	282701	558	283937	678	285665	958
269825	247	271392	106	276267	700	282718	558	283944	678	285672	958
269832	60	271408	106	276274	700	282725	558	284002	94	285689	958
269849	60	271422	106	276281	700	282749	558	284019	94	285696	958
269856	68	271439	423	276304	634	282756	558	284286	334	285702	958
269863	68	271446	678	276311	634	282770	558	284309	500	285719	958
269870	68	271453	678	276328	558	282787	558	284316	476	285726	958
269986	434	271538	313	276335	626	282824	558	284330	334	285887	960
270005	482	271545	313	276342	626	282848	558	284354	500	285894	960
270012	192	271590	946	276366	612	282862	558	284361	476	285900	960
270029	192	271606	946	277004	934	282879	558	284460	91	285917	960
270036	434	271613	946	277011	934	282886	558	284477	374	285924	960
270043	192	271620	944	277028	934	282893	558	284484	510	285993	558
270050	192	271637	946	277035	934	282909	558	285061	68	286006	558
270173	634	271644	944	277219	378	282916	558	285078	68	286051	558
270180	634	271712	634	277226	378	282923	558	285085	88	286068	558
270197	634	271750	634	277233	378	282930	558	285092	88	286075	558
270203	634	272030	399	277240	378	282947	558	285108	390	286082	558
270210	634	272078	460	277257	378	282954	558	285115	390	286099	558
270241	248	272085	514	277288	292	282961	558	285122	126	286105	558
270258	248	272108	914	277370	108	282978	558	285139	132	286112	558
270265	248	272139	170	277387	108	282985	558	285146	132	286129	558
270272	248	272238	478	277394	108	282992	558	285153	132	286167	558
270289	248	272245	526	277417	308	283029	558	285160	132	286204	558

Indice per codice

SKU	Pag	287874	728	292953	644	301631	960	303697	558	305813	784
		287881	728	293004	434	301648	960	303703	558	305837	784
286211	558	287898	728	293172	889	301655	960	303710	558	305844	760
286228	558	287904	728	293189	894	301662	960	303727	558	305851	760
286259	558	287911	728	293196	894	301679	960	303741	558	306421	960
286266	558	287928	728	293202	894	301686	960	303789	558	306452	512
286297	558	287935	728	293646	431	301693	960	303796	558	306469	512
286303	558	287942	728	293653	339	301709	960	303802	558	306537	108
286310	558	287959	644	293660	339	301716	960	303819	558	306544	108
286327	558	287966	644	293769	286	302225	395	303826	558	306551	108
286334	558	288147	728	293776	286	302232	395	303833	558	306575	248
286341	558	288208	954	293783	286	302256	648	303895	60	306582	248
286358	558	288215	954	293790	286	302263	648	304038	958	306599	248
286365	558	288239	956	294001	889	302270	648	304045	958	306605	248
286372	558	288260	338	294025	889	302287	648	304113	482	306612	248
286389	558	288277	338	294049	889	302294	648	304120	192	306629	248
286396	558	288338	558	294766	413	302348	612	304137	335	306636	248
286402	558	288383	955	294803	413	302355	612	304144	100	306643	248
286419	558	288390	130	294810	318	302362	612	304151	477	306650	248
286426	558	288406	130	294827	318	302379	612	304168	520	306667	248
286433	558	288420	130	295213	504	302539	678	304366	68	306674	248
286440	558	288437	130	295473	511	302546	678	304373	68	306681	248
286495	558	288444	130	295497	511	302553	678	304380	68	306698	248
286501	558	288451	130	295503	511	302560	678	304397	68	306780	894
286518	558	288475	130	295510	458	302577	678	304403	68	306797	894
286525	558	288543	956	295534	458	302584	678	304410	68	306803	894
286532	558	289151	455	295541	458	302591	678	304427	68	306810	408
286549	558	289168	455	296302	558	302607	678	304434	68	306827	408
286594	686	289212	944	296333	692	302614	678	304441	68	306834	889
286600	686	289229	944	296340	692	302621	678	304458	68	306841	889
286662	522	289281	558	296357	692	302744	678	304465	68	306858	889
286679	522	289298	558	296364	692	302751	678	304472	68	306872	889
286686	522	289304	558	296678	512	302768	678	304489	362	306940	431
286716	870	289489	331	296685	512	302942	686	304496	362	306957	339
286723	870	289496	331	296746	106	302959	686	304502	362	306964	339
286730	870	289786	164	296753	106	302966	686	304519	244	306988	498
286747	870	289861	164	296869	955	302973	686	304526	244	306995	105
287072	378	289878	164	296876	955	302980	686	304533	244	307008	105
287300	409	289908	164	297101	285	302997	686	304540	64	307015	372
287317	409	289915	164	297149	285	303000	686	304557	64	307022	372
287560	371	289939	164	297743	281	303017	686	304564	64	307039	372
287577	371	290614	558	297750	281	303062	960	304571	64	307046	372
287584	371	290959	499	297767	159	303079	960	304588	64	307053	372
287591	372	290966	499	297781	159	303086	960	304595	64	307060	372
287607	372	291093	459	298597	881	303093	960	304601	434	307077	958
287614	372	291109	459	298610	881	303314	306	304618	482	307084	958
287621	372	291345	75	299402	302	303321	306	304625	192	307091	958
287638	372	291376	75	299419	302	303390	958	304632	192	307107	958
287645	372	291406	75	299617	501	303406	958	304649	520	307114	958
287652	395	291789	408	299624	501	303499	558	304694	60	307121	958
287669	395	291796	408	300504	558	303505	558	304700	60	307138	958
287676	395	292205	248	300528	558	303512	558	304717	60	307145	652
287683	825	292236	248	300535	558	303529	558	304724	60	307152	652
287690	825	292250	248	300641	873	303574	558	304731	60	307169	825
287706	825	292403	423	300658	873	303598	558	304748	60	307176	825
287713	825	292410	423	300764	558	303604	558	304915	506	307206	286
287720	825	292441	473	300801	84	303611	558	304922	506	307213	286
287737	825	292458	473	300818	84	303628	558	305431	954	307244	248
287768	388	292465	473	300825	84	303635	558	305486	954	307404	130
287775	388	292472	473	301051	502	303642	558	305592	514	307411	130
287782	388	292830	290	301068	502	303659	558	305608	558	307428	130
287843	728	292847	290	301075	502	303666	558	305615	558	307510	558
287850	728	292922	558	301594	958	303673	558	305622	946	307527	558
287867	728	292939	644	301624	960	303680	558	305639	946	307534	558

307541	558	313252	428	317243	108	320618	558	322322	678	323657	720
307558	558	313283	336	317250	108	320625	558	322339	678	323671	720
307565	558	313290	336	317267	114	320717	558	322346	678	323688	720
307572	558	313313	505	317274	114	320724	558	322353	884	323718	720
307589	558	313320	472	317281	114	320731	558	322360	678	323725	720
307596	558	313412	843	317489	308	320748	558	322377	678	323732	720
307602	558	313429	843	317496	308	321042	80	322384	884	323763	720
307619	956	313436	843	317502	308	321059	80	322391	678	323770	720
307626	956	313443	843	317564	845	321172	104	322421	891	323794	720
307695	60	313450	843	317571	845	321189	837	322438	884	323800	720
307701	60	313467	838	317793	106	321196	837	322452	884	323817	720
307756	760	313474	838	317809	423	321202	837	322476	558	323831	720
307855	955	313481	838	317816	498	321462	138	322483	884	323961	720
307862	955	313498	838	317823	473	321479	138	322490	558	323985	720
307879	954	313504	838	317908	286	321509	413	322506	884	324005	720
307886	954	313511	836	317953	558	321516	318	322513	558	324807	720
308227	894	313528	836	317960	558	321523	318	322537	884	324814	720
308234	894	313535	836	317977	558	321530	413	322544	884	324821	720
309262	324	313542	836	317984	558	321547	371	322551	884	324838	720
309279	324	313559	836	317991	558	321554	371	322568	884	324845	720
309286	324	313566	836	318103	808	321561	371	322575	884	324852	720
309798	179	313771	114	318110	808	321585	514	322582	884	324869	720
309804	179	313788	114	318127	808	321615	286	322599	884	324876	720
309811	179	314099	414	318134	808	321622	925	322605	848	324883	720
310107	456	314105	414	318141	808	321639	906	322612	884	324890	720
310114	456	314129	414	318196	841	321646	845	322629	826	324906	720
310121	456	314136	414	318202	841	321653	558	322636	826	324913	720
310138	392	314143	178	318219	841	321660	266	322643	826	324920	720
310145	392	314167	178	318226	841	321684	264	322650	826	324937	720
310152	392	314174	178	318233	924	321691	845	322667	338	325019	916
310589	127	314198	496	318264	260	321707	266	322674	338	325132	941
310596	127	314204	465	318325	471	321714	558	322681	826	325156	941
310602	127	314228	341	318691	884	321738	264	322698	338	325163	941
310664	429	314235	341	318707	884	321745	266	322704	826	325750	558
310671	337	314334	431	318820	877	321752	264	322711	302	325767	558
310688	337	314716	320	318837	802	321769	266	322728	850	325804	67
310787	384	314723	320	319568	302	321776	264	322735	850	325828	67
310800	168	314815	340	319575	302	321783	86	322742	423	325835	67
310817	470	314822	340	319582	302	321806	558	322759	473	325934	644
310886	308	314921	66	319650	742	321813	86	322766	106	325941	644
310893	308	314938	66	319667	742	321844	558	322773	106	325958	644
311265	958	314945	145	319674	742	321851	906	322780	106	325965	644
311272	958	314952	145	319681	742	321868	906	322797	106	325972	644
311319	429	314969	145	319797	302	321882	906	322803	138	325989	644
311340	332	315805	348	319803	302	321905	906	322810	558	326214	855
311357	332	315812	348	320373	296	321929	906	322841	558	326221	855
311364	332	316048	890	320434	558	321950	906	322858	558	326238	805
311661	864	316055	890	320441	558	321967	558	322889	760	326245	805
311678	864	316307	558	320458	558	321967	558	322899	760	326290	956
311685	864	316680	338	320465	558	321981	906	322919	760	326290	956
311708	864	316697	338	320472	558	321998	558	322971	760	326351	108
311715	866	316789	372	320489	558	322056	558	323008	760	326368	108
311760	393	316871	859	320496	558	322070	558	323237	872	326610	944
311777	393	316895	859	320502	558	322087	686	323244	872	326627	842
311784	393	316901	859	320519	558	322094	686	323251	872	326634	842
312323	288	317007	338	320526	558	322100	686	323527	720	326658	515
312330	288	317090	385	320533	558	322124	686	323534	720	326665	515
312347	288	317106	385	320540	558	322193	829	323541	720	326672	515
312354	288	317113	282	320557	558	322209	829	323558	720	326689	882
312361	288	317120	282	320564	558	322216	884	323589	720	326696	882
312378	288	317137	519	320571	558	322230	884	323596	558	326702	882
312491	269	317144	519	320588	558	322261	904	323602	720	326719	882
313191	742	317151	468	320595	558	322278	904	323619	720	326726	882
313207	742	317168	468	320601	558	322285	858	323633	720	326733	882
						322308	858	323640	720	326740	882

Indice per codice

SKU	Pag	327914	469	328614	866	332406	271	336787	406	340609	558
		327921	414	328621	859	332413	271	336794	406	340623	558
326757	882	327938	414	328638	859	332420	271	336800	406	340647	558
326788	856	327945	393	328645	859	332451	558	336817	406	340791	686
326795	806	328010	272	328652	843	332468	538	337135	946	340807	686
326801	806	328027	272	328669	843	332475	538	337142	742	340814	686
326849	842	328034	272	328676	843	332482	538	337371	714	340821	686
326856	842	328041	272	328683	958	332499	538	337388	714	340838	678
326863	825	328058	272	328690	958	332505	538	337395	714	340845	678
326870	825	328065	272	328706	958	332512	538	337401	714	340852	678
326887	808	328072	272	328713	958	332529	538	337418	714	340869	678
326894	808	328089	272	328720	958	332536	538	337425	714	340876	678
326917	890	328096	272	328737	958	332543	538	337517	694	340883	678
326924	890	328102	114	328744	958	332581	538	337524	696	340890	678
326955	844	328119	114	328751	958	332628	538	337531	916	340906	678
326962	828	328126	114	328768	958	332635	538	337548	818	340913	678
326979	846	328133	114	328775	958	332659	538	337579	686	340920	678
326986	844	328140	288	328782	958	332703	538	339047	172	340937	678
326993	844	328157	288	328799	308	332710	538	339054	172	340944	678
327037	956	328164	508	328812	308	332734	538	339061	172	340951	678
327044	956	328171	508	328829	908	332758	538	339252	192	340968	678
327051	956	328188	320	328836	908	332765	538	339269	192	340975	678
327068	956	328195	320	328942	272	332772	538	339276	192	340982	678
327075	956	328201	332	328959	272	332789	538	339283	194	340999	390
327242	896	328218	332	328966	272	332796	538	339290	194	341002	390
327259	896	328225	332	328973	272	332802	538	339306	194	341019	390
327266	896	328232	336	328980	272	332819	538	339313	196	341026	390
327402	164	328249	336	329260	272	332826	538	339320	196	341033	88
327419	164	328256	336	329444	598	332833	538	339337	196	341040	88
327426	164	328263	336	329451	598	332840	538	339368	538	341057	84
327433	164	328270	428	329468	598	332857	538	339375	538	341064	84
327440	164	328287	428	329475	598	332864	538	339382	538	341071	84
327457	164	328294	472	329505	598	332871	538	339399	538	341088	84
327471	760	328300	472	329512	598	332888	538	339405	538	341095	84
327488	760	328317	505	329529	598	332895	538	339412	538	341101	84
327495	760	328324	505	329536	598	332901	538	339429	538	341118	502
327501	784	328331	127	329574	598	332918	538	339726	86	341125	502
327518	784	328348	127	329581	598	332925	538	339733	86	341132	502
327525	558	328355	127	329598	598	332932	538	339740	86	341149	248
327532	558	328362	269	329604	598	332949	538	339757	86	341156	248
327549	558	328379	324	329635	598	333007	283	339771	956	341163	248
327556	558	328386	324	329642	598	333014	283	339788	652	341170	248
327563	260	328393	324	329666	598	333045	148	339795	652	341187	248
327570	260	328409	324	329673	598	333915	946	339863	558	341194	248
327600	260	328416	324	329703	598	333922	946	339887	700	341200	248
327686	260	328423	324	329710	598	334974	467	339894	700	341217	248
327693	260	328430	337	330358	598	334981	467	340005	700	341224	248
327716	431	328447	337	330365	598	334998	467	340012	700	341231	248
327754	742	328454	337	330730	558	335001	467	340029	700	341248	248
327761	742	328461	337	330754	558	335018	467	340036	700	341255	248
327778	392	328478	429	331225	798	335025	467	340043	558	341309	247
327785	392	328485	333	331256	754	335261	946	340067	558	341316	247
327792	392	328492	348	331263	754	336008	308	340081	558	341323	247
327808	324	328508	864	331355	920	336176	90	340104	558	341330	742
327815	324	328515	864	331386	920	336183	90	340180	558	341347	742
327822	324	328522	836	331690	395	336190	90	340197	558	341354	742
327839	100	328539	836	332062	558	336206	90	340241	558	341361	742
327846	100	328546	836	332079	558	336220	512	340265	558	341378	742
327853	335	328553	836	332086	558	336510	372	340364	558	341385	742
327860	335	328560	836	332093	558	336534	428	340388	558	341392	742
327877	477	328577	836	332109	558	336626	697	340401	558	341408	742
327884	159	328584	838	332116	558	336664	428	340425	558	341415	742
327891	281	328591	838	332239	644	336671	428	340562	558	341422	742
327907	469	328607	838	332246	644	336770	406	340586	558	341439	272

341446	272	342184	68	343310	78	345307	512	346137	196	346892	868
341453	272	342191	68	343457	102	345314	515	346144	196	346908	868
341460	272	342221	362	343464	102	345321	425	346151	196	346915	868
341477	272	342238	362	343471	102	345338	425	346168	196	346922	868
341484	272	342245	362	343488	466	345345	108	346175	196	346939	868
341491	272	342252	362	343501	598	345352	108	346182	196	347738	837
341507	272	342269	362	343518	598	345369	108	346199	196	347745	866
341514	272	342276	362	343525	598	345376	108	346205	196	347752	866
341521	60	342283	244	343532	598	345383	108	346212	652	347769	866
341538	60	342290	244	343617	164	345390	108	346229	652	347776	866
341545	60	342306	244	343624	164	345406	108	346236	652	347783	866
341552	60	342313	244	343631	164	345413	108	346243	652	347790	866
341569	60	342320	244	343648	164	345420	108	346250	652	347806	866
341576	60	342337	244	344751	558	345437	108	346267	652	347813	866
341583	60	342344	64	344768	558	345468	308	346274	652	347820	866
341590	60	342351	64	344775	494	345475	308	346281	652	347837	866
341606	60	342368	64	344782	558	345482	406	346298	652	347844	866
341613	60	342375	64	344799	558	345499	406	346304	652	347851	866
341620	60	342382	64	344805	760	345505	406	346328	644	347868	866
341637	60	342399	64	344812	760	345512	80	346335	644	347875	874
341644	784	342405	64	344829	760	345611	841	346342	644	347882	874
341668	784	342412	64	344836	760	345628	924	346359	644	347899	874
341675	784	342429	64	344843	754	345635	924	346366	644	347905	874
341682	784	342436	64	344850	754	345642	924	346373	644	348193	192
341705	784	342443	64	344867	754	345659	924	346380	644	348209	192
341712	784	342450	64	344874	754	345666	920	346397	644	348216	192
341729	784	342467	452	344881	648	345673	916	346403	644	348223	192
341736	784	342474	452	344898	648	345765	644	346410	644	348230	192
341743	784	342481	452	344904	648	345772	644	346427	644	348247	192
341750	784	342498	452	344911	648	345789	644	346434	644	348254	192
341767	784	342504	452	344928	648	345796	644	346441	644	348261	192
341774	784	342511	452	344935	648	345802	946	346458	644	348278	294
341781	302	342566	264	344942	697	345819	946	346465	644	348285	499
341798	302	342573	266	344966	714	345826	946	346472	644	348292	499
341842	780	342580	264	344973	714	345833	946	346489	644	348308	678
341859	780	342597	266	344980	598	345840	946	346496	644	348315	678
341866	780	342603	264	344997	598	345857	946	346502	644	348322	678
341873	780	342610	266	345000	598	345864	946	346519	644	348339	874
341880	242	342627	264	345017	598	345871	434	346526	471	348346	874
341897	242	342634	266	345024	598	345888	482	346533	431	348353	874
341903	242	342641	378	345031	598	345895	192	346540	166	348360	874
341910	242	342658	378	345048	598	345901	192	346557	166	348377	868
341927	242	342665	378	345055	598	345918	192	346564	166	348384	634
341934	242	342689	808	345062	598	345925	192	346571	166	348391	634
341941	242	342696	808	345079	598	345932	192	346588	166	348407	634
341958	242	342702	808	345086	598	345949	434	346595	166	348414	634
341965	242	342719	808	345093	598	345956	482	346601	166	348674	164
341972	242	342726	808	345130	395	345963	192	346618	166	348681	164
341989	242	342740	686	345147	395	345970	194	346625	166	348698	164
341996	242	342757	558	345154	372	345987	194	346632	166	349060	742
342009	68	342788	302	345161	372	345994	194	346656	896	349077	742
342016	68	342795	302	345178	372	346007	194	346663	896	349084	742
342023	68	342801	714	345185	372	346014	194	346670	896	349121	678
342030	68	342818	714	345192	372	346021	194	346687	896	349138	678
342047	68	342825	714	345208	372	346038	194	346694	896	349145	678
342054	68	342832	714	345215	58	346045	194	346700	896	349596	920
342061	68	342849	714	345222	58	346052	194	346717	896	351278	932
342078	68	342856	714	345239	58	346069	194	346724	896	351285	932
342108	68	342863	946	345246	58	346076	194	346731	896	351346	558
342115	68	342870	946	345253	58	346083	194	346762	652		
342122	68	342887	954	345260	58	346090	196	346779	652		
342139	68	342894	956	345277	58	346106	196	346847	192		
342160	68	342900	955	345284	58	346113	196	346854	78		
342177	68	342993	104	345291	58	346120	196	346861	78		

Elenco finiture



Trasparente



Bianco

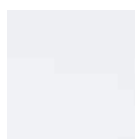

Opale



Iride



Cromo Sfumato



Acciaio



Argento

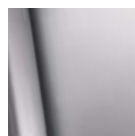

Cromo



Cemento

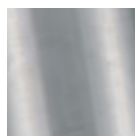

Alluminio

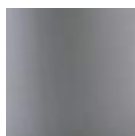

Grigio

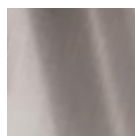

Nickel

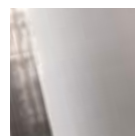

Fumè



Fumè Sfumato



Granito

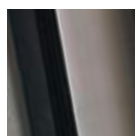

Piombo



Antracite



Nero



Avorio



Ambra



Ambra Sfumato



Alabastro



Beige



Canvas

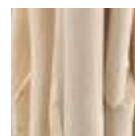

Legno



Tortora

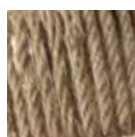

Corda



Oro

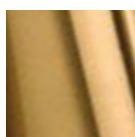

Ottone

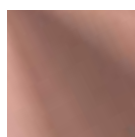

Rame



Coffee

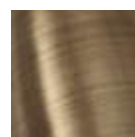

Brunito



Ruggine

Note

Le finiture rappresentate hanno scopo illustrativo. Le tonalità sono soggette a variazioni dettate dal tipo di materiale impiegato e dalla sua lavorazione che possono alterarne la resa, di conseguenza articoli catalogati con medesima finitura potranno presentare delle differenze nella percezione del colore.

Icone tecniche



Classe I Sicurezza elettrica garantita dall'isolamento principale e da un conduttore di protezione (messa a terra) collegato alla struttura metallica della lampada. Messa a terra obbligatoria.



Classe II Sicurezza elettrica garantita dall'isolamento principale e da un doppio isolamento o da un isolamento rinforzato. Non deve avere messa a terra.



Classe III Sicurezza elettrica garantita dall'alimentazione a bassissima tensione (inferiore a 50 Volt). Non deve avere messa a terra.



Apparecchio non idoneo al montaggio diretto o incasso su superfici normalmente infiammabili.



Marchio di conformità alle direttive comunitarie europee di sicurezza.

Simboli



Lampadina inclusa.



Articoli con lampade a LED: consumo estremamente ridotto, luce chiara e concentrata, robustezza e lunga durata.



Interruttore integrato nel corpo luce.



Apparecchio dotato di interruttore touch: si accende e si regola l'intensità col tocco di un dito sul corpo luce.



Apparecchio fornito con variatore di potenza.



Lampada con presa USB integrata.



Luce indiretta inclusa.



Prodotto ad alto contenuto tecnologico, elevata qualità dei materiali, destinato ad uso professionale.



Articolo con UGR.



Articolo adatto alla pittura e verniciatura.



Grado di protezione.



Articolo in acciaio inox 316.



Lampada con rilevazione di presenza inclusa PIR (Passive InfraRed).



Lampada con batteria ricaricabile inclusa.

Note

-I prezzi indicati sono riferiti al pubblico IVA esclusa.

-Ideal lux s.r.l. si riserva il diritto di apportare, in qualunque momento e senza preavviso, tutte le modifiche necessarie a migliorare la qualità degli articoli illustrati nel presente catalogo. Per verificare le caratteristiche più aggiornate, consultare la documentazione nel sito web (www.ideal-lux.com).

-I nostri prodotti in classe I e II si alimentano con tensione nominale di 220-240 vac 50/60 hz. Tutti i nostri prodotti sono conformi alle direttive CE.

-Qualora acquistato separatamente come "optional", il driver dimmerabile sarà già incluso nel prodotto in sostituzione del driver standard on-off: verrà fornito un solo driver.

-I Watt indicati a catalogo esprimono la potenza NOMINALE dell'articolo comprensivo di sorgente e driver, quando inclusi. I valori riferiti ai lm relativi alle lampade con sorgenti integrate a LED, sono da considerarsi NOMINALI,

riferiti cioè alla sorgente. Per i lm effettivi dei singoli apparecchi illuminanti si prega gentilmente di consultare le fotometrie.

-Il valore UGR non è una caratteristica dell'apparecchio, ma dell'installazione. Gli UGR riportati in questo catalogo sono stati calcolati tenendo conto di un'installazione ideale e sono raggruppati nei blocchi <10 <13 <16 <19 <22. Si consiglia di calcolare l'UGR specifico secondo la propria installazione.

-La durata di vita utile delle sorgenti LED di tutti gli articoli presenti a catalogo è riferita al valore L70B50, quando non dichiarato altrimenti.

Ideal Lux s.r.l.

Headquarter

Via Taglio Destro, 32
30035 Mirano – Venezia
P.I. / C.F. 02420040277
8.00 - 12.00 / 13.30 - 17.30

Warehouse

Via delle Industrie, 8/D
30036 Santa Maria di Sala – Venezia
8.00 - 12.00 / 13.00 - 17.00

E info@ideal-lux.com
T +39 041 5790500
F +39 041 8872349

🌐 [ideal.lux](https://www.ideal-lux.com)
📘 Ideal Lux

www.ideal-lux.com

Community Design Pending Nr. 001996372 002194993 002621862 002943449 003734342 004558609 006083655

Copyright 2025 © IDEAL LUX S.r.l. – All rights reserved – Tutti i diritti sono riservati



