

Sospensioni, Lampade da soffitto, Lampade da parete,
Lampade da tavolo, Lampade da terra, Sistemi, Proiettori
e Binari, Lampade da incasso, Lampade da esterno.
Selezione per designer e architetti.

Light is about moments.

ideal lux. selection

Ideal Lux s.r.l.

Headquarter

Via Taglio Destro, 32
30035 Mirano — Venezia
P.I. / C.F. 02420040277
8.00 - 12.00 / 13.30 - 17.30

Warehouse

Via delle Industrie, 8/D
30036 Santa Maria di Sala — Venezia
8.00 - 12.00 / 13.00 - 17.00

E info@ideal-lux.com

T +39 041 5790500

F +39 041 8872349

Ig: [ideal.lux](#)

Fb: [Ideal Lux](#)

www.ideal-lux.com

Copyright 2024 © IDEAL LUX S.r.l.

All rights reserved

Tutti i diritti sono riservati

Questo catalogo è una selezione dei nostri prodotti pensata per designer, architetti e professionisti dell'illuminazione.

È stata ideata come risorsa per guidarvi nel percorso creativo, offrendo ispirazione e strumenti per individuare rapidamente le opzioni più adatte alle vostre visioni.

La nostra esperienza nel bilanciare forma e funzione si riflette su ogni prodotto proponendo soluzioni di illuminazione che parlano sia all'estetica contemporanea che alla funzionalità senza tempo.

Il team di Ideal Lux è pronto ad accompagnarvi in questo viaggio.

Raffaele Strano, CEO

A handwritten signature in black ink, appearing to read 'Raffaele Strano', written in a cursive style.

La luce offre accoglienza, riparo, calore, raccoglimento, intimità. Viene celebrata da Ideal Lux attraverso i suoi prodotti, lampade d'arredo essenziali. La sfida che ogni giorno si impegna a vincere è quella di unire il design dei prodotti e l'immaterialità della luce per creare spazi personalizzati e unici, in grado di raccontare la storia di chi li anima.

Chiunque lavori nell'ideazione degli spazi da vivere può trovare in Ideal Lux il partner ideale per definire aree capaci di raccontare le vite dei propri clienti, creando contesti in cui ognuno diventa il protagonista della propria storia. Ambienti che rappresentano al meglio la personalità e il gusto di chi li abita.

La luce è una forma di energia pura che crea gioia e che non solo ci permette di vedere, ma influenza il nostro umore e benessere.

L'attenzione per le persone è centrale, ed è per questo motivo che ogni sistema di illuminazione è pensato per valorizzare ogni istante e ogni luogo, al fine di dare l'opportunità di esprimere al meglio ciò che è importante per ognuno di noi.

Adesso la luce non è più solo funzionale a illuminare un ambiente, ma lo nobilita, esprimendo appieno l'essenza che il progettista ha voluto imprimere attraverso geometrie e materiali.

Ogni spazio, se illuminato con la luce giusta, assume un significato più profondo, autentico e vitale, raccontando i diversi momenti del nostro quotidiano.



LIGHT IS

ABOUT MOMENTS

Dal 1974, Ideal Lux si dedica con passione alla realizzazione di complementi d'arredo illuminotecnici in grado di soddisfare ogni tipo di necessità. La collezione *Selection* raccoglie alcuni tra i più di 3700 prodotti offerti dall'azienda, pensata per abbracciare un gusto moderno e orientato al design.

LIGHT TALES

SIA LA LUCE
CHE I MOMENTI
POSSONO ESSERE
FUGACI.
LA LUCE
CHE SCOMPARE
SPEGNENDO
L'INTERRUTTORE,
I MOMENTI
CHE PASSANO
IN UN BATTER
D'OCCHIO.
TUTTO QUESTO
LI RENDE
INDIMENTICABILI.

L'attenzione e la dedizione al cliente sono il fondamento stesso di Ideal Lux. Il nostro Customer Care costituisce un pilastro fondamentale all'interno dell'azienda, con un'enfasi sull'affidabilità come nostro valore cardine. Poniamo le esigenze delle persone al vertice delle nostre priorità.

Per noi la qualità non può esistere senza garanzia. Abbiamo ampliato la copertura a 5 anni su tutti i nostri complementi illuminotecnici, per assicurare sempre gli standard più elevati nei prodotti e nei servizi offerti.





LAMPADE DA PARETE
P. 150

INDICE SEZIONI

SCHEDA TECNICHE
P. 481



LAMPADE DA TAVOLO
P. 196

LAMPADE DA SOFFITTO
P. 120



SOSPENSIONI
P. 14



LAMPADE DA TERRA
P. 236



INDICE SEZIONI

SCHEDE TECNICHE
P. 481



LAMPADE DA INCASSO
P 350



PROIETTORI E BINARI
P 286



SISTEMI
P 286



LAMPADE DA ESTERNO
P 378

INDICE ALFABETICO

INTERNI → IN
ESTERNI → OUT

AGOS OUT
→ Da terra 380

ANDROMEDA OUT
→ Da parete 388

BEAN IN
→ Da parete 152

BENTO IN
→ Da incasso 352

BIRDS IN
→ Sospensione 488
→ Da soffitto 122
→ Da parete 489
→ Da tavolo 489
→ Da terra 238

CLIP IN
→ Da parete 156

COVER IN
→ Da parete 160

DELTA IN
→ Da parete 166

DIESIS IN
→ Sospensione 492
→ Da tavolo 492
→ Da terra 244

DISPLAY IN
→ Proiettore 288

DJAMBE OUT
→ Da terra 392

DORSALE IN
→ Da terra 252

DOT IN
→ Da soffitto 126

DYNAMITE IN
→ Sospensione 495
→ Da soffitto 130

EGO IN
→ Sistema 296

EOS IN
→ Proiettore 316

EQUINOXE IN
→ Sospensione 16
→ Da parete 497
→ Da terra 258

ESSENCE IN
→ Sospensione 498
→ Da parete 172

FADE IN
→ Sospensione 20

FILO IN
→ Sospensione 26
→ Da parete 500
→ Da tavolo 501
→ Da terra 264

FLUO IN
→ Sistema 324

FLY IN
→ Da soffitto 136

FOCUS IN
→ Da parete 178

FOX IN
→ Proiettore 330

FRAME IN
→ Sospensione 30
→ Da soffitto 142
→ Da terra 508

FUTURA IN
→ Da tavolo 198
→ Da terra 508

GAME IN
→ Da incasso 358

GEMINI IN
→ Sospensione 38
→ Da soffitto 510

GUN OUT
→ Da soffitto 596
→ Da parete 400

IPOTESI OUT
→ Da terra 408

JEDI OUT
→ Da terra 414

LIKA IN
→ Da incasso 364

LINK IN
→ Binario 580

LINUS IN
→ Sistema 334
→ Da parete 588

LOLITA OUT
→ Da tavolo 420

LOOK IN
→ Sospensione 44
→ Da soffitto 511
→ Da parete 512
→ Da terra 512
→ Per binari 513

MAPA BIANCO	IN	PIVOT	IN	VEGA	OUT
→ Sospensione	52	→ Da tavolo	218	→ Da terra	472
→ Da soffitto	515	QUICK	IN	VIRUS	IN
→ Da parete	515	→ Proiettore	340	→ Da incasso	374
→ Da tavolo	204	SET UP	IN	YOKO	IN
MINT	IN	→ Sospensione	532	→ Sospensione	537
→ Sospensione	58	→ Da soffitto	532	→ Da tavolo	230
MIX UP	IN	→ Da parete	186	→ Da terra	280
→ Sospensione	62	→ Da tavolo	224	ZIG ZAG	IN
→ Da soffitto	518	→ Da terra	276	→ Da parete	190
→ Da terra	518	SIRIO	OUT		
MOBY	IN	→ Da terra	428		
→ Sospensione	74	SOLE	OUT		
NEMO	IN	→ Sospensione	599		
→ Sospensione	80	→ Da terra	436		
NOVA	IN	SPIKE	IN		
→ Da incasso	368	→ Da soffitto	146		
ONION	IN	STARLIGHT	OUT		
→ Sospensione	86	→ Proiettore	442		
ORACLE SLIM	IN	STYLE	OUT		
→ Sospensione	94	→ Da parete	602		
→ Da soffitto	523	→ Da terra	448		
OZ	IN	TAURUS	OUT		
→ Sospensione	102	→ Da incasso	454		
→ Da soffitto	524	TECHO	OUT		
→ Da parete	525	→ Da soffitto	460		
→ Da tavolo	210	TESI	IN		
PERLAGE	IN	→ Sistema	346		
→ Sospensione	108	TESLA	OUT		
→ Da soffitto	528	→ Da terra	466		
→ Da parete	530	ULTRATHIN	IN		
→ Da tavolo	530	→ Sospensione	114		
→ Da terra	270	PIANO	IN		
→ Sospensione	182	→ Da parete	182		

SOSPENSIONI

SGUARDO
AMOREVOLE,
TERRA UMIDA,
MANI SAPIENTI,
ACQUA FRESCA,
FOGLIE
CHE BRILLANO,
LUCE
CHE VIBRA,
LAMPADA
ACCESA,
GOCCE
CHE CADONO,
PIANTE
RIGOGLIOSE.





Indice

↳

16	Equinoxe
20	Fade
26	Filo
30	Frame
38	Gemini
44	Look
52	Mapa Bianco
58	Mint
62	Mix Up
74	Moby
80	Nemo
86	Onion
94	Oracle Slim
102	Oz
108	Perlage
114	Ultrathin

SOLO SCHEDE TECNICHE	488	Birds
	492	Diesis
	495	Dynamite
	498	Essence
	532	Set Up
	537	Yoko



EQUINOXE

Montatura in metallo
con finitura cromo o ottone
antico. Diffusori in vetro
soffiato trasparente.

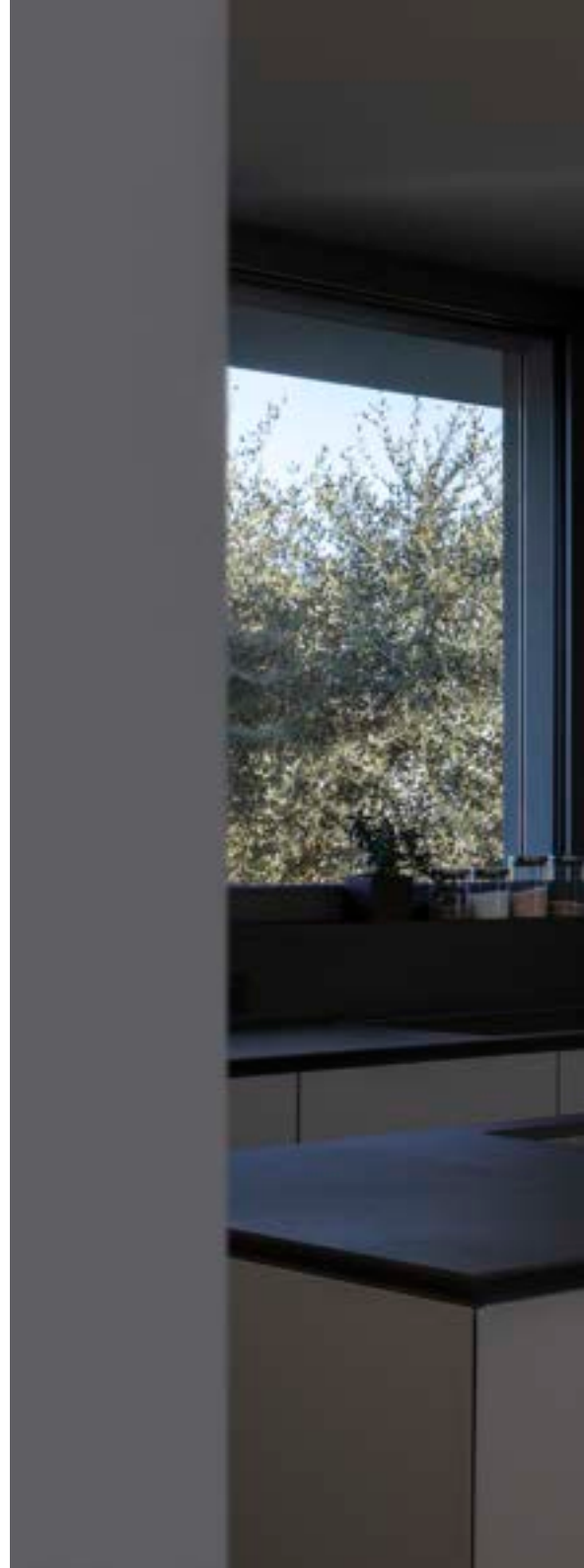









FADE

Rosone e montatura in metallo.
Paralume in vetro soffiato trasparente
con sfumatura galvanica. Diffusore
interno in vetro soffiato bianco
acidato. Cavo in pvc nero. Colori
paralumi: trasparente con sfumatura
ambra, cromo o rame.







IDEAL LUX

INTERNI

SOSPENSIONI

FADE







FILO

Base e corpi luci in metallo
verniciato a polveri o placcato.
Cavi elettrici in pvc nero. Colori:
bianco, nero oppure ottone satinato.
Modelli 300801, 300818 e 300825
disponibile come 4 metri di cavo.











FRAME

Base e montatura in metallo verniciato bianco opaco o nero opaco. Diffusori in materiale plastico colore opale. Cavi regolabili in lunghezza. Emissione luce diretta.



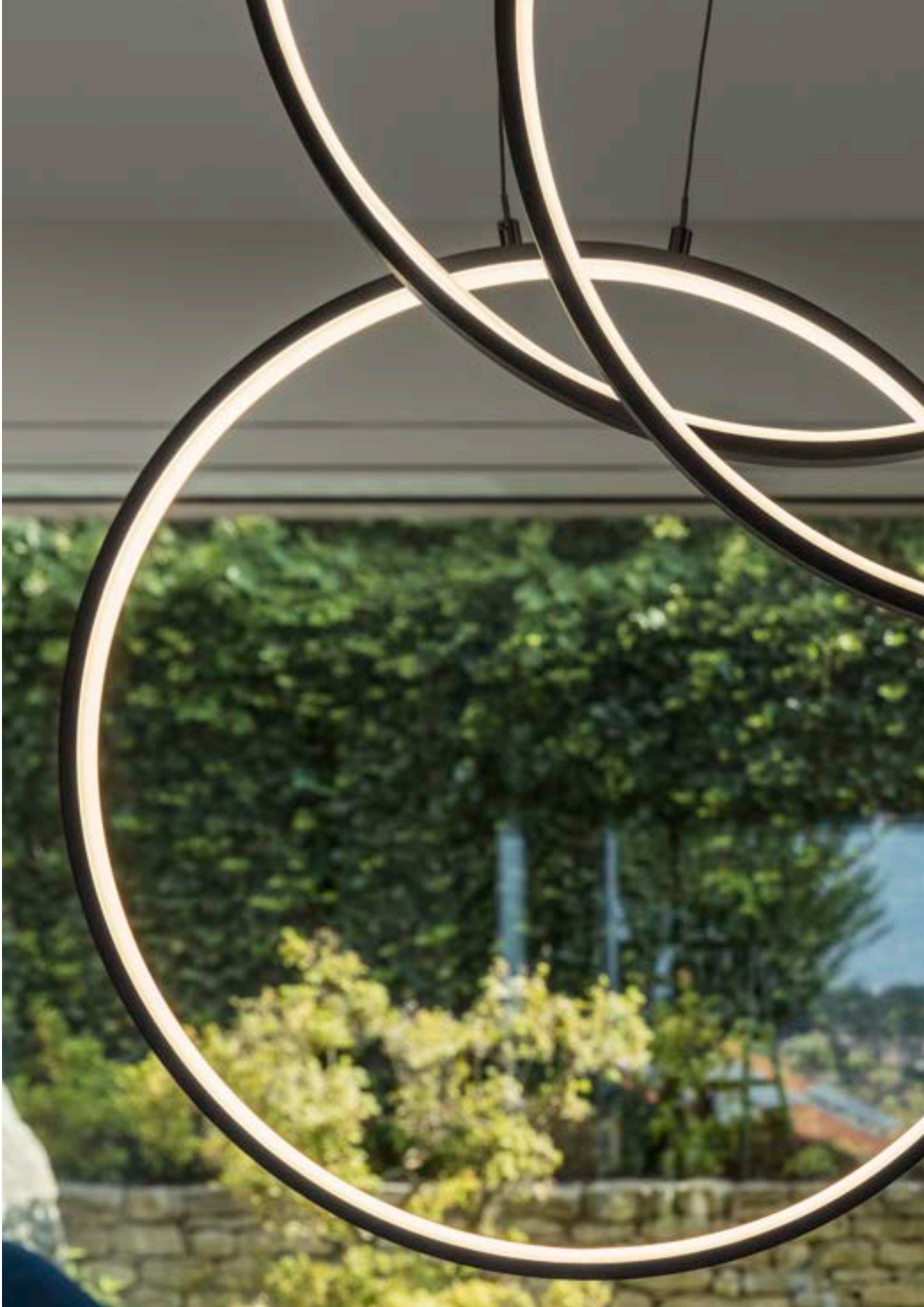

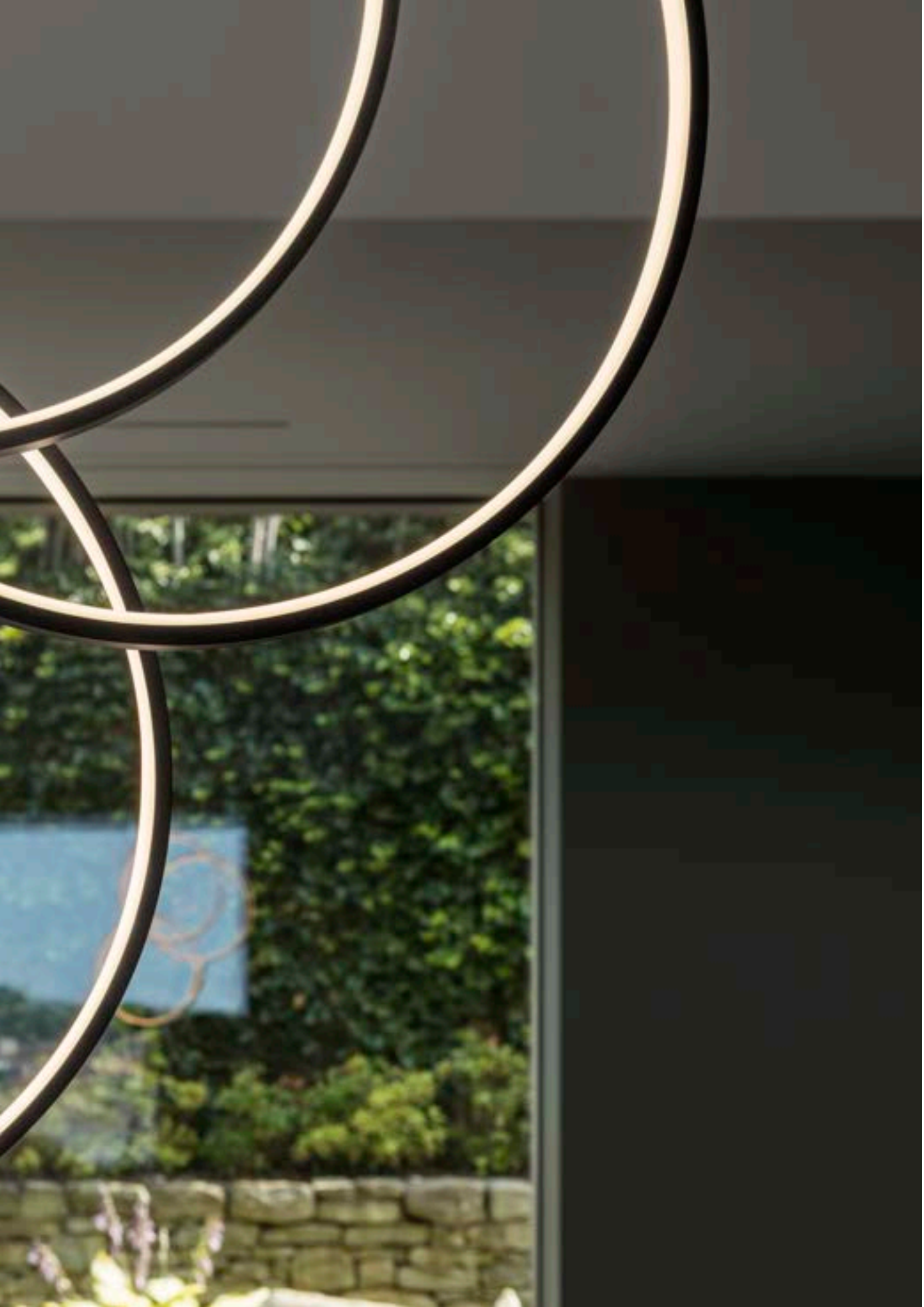











GEMINI

Rosone e paralume in metallo verniciato a polveri o placcato. Diffusore in policarbonato opale. Cavo in pvc trasparente. Disponibile nelle finiture bianco, nero o ottone spazzolato. Modelli con diametro 810 mm e 610 mm disponibili anche in versione dimmerabile DALI/Push.













LOOK

Rosone e diffusore in metallo con varie finiture. Cavo in tessuto regolabile in lunghezza. Monta lampadine sostituibili. Modello con finitura cromo sfumato con diffusore in vetro.



















MAPA BIANCO

Montatura in metallo bianco.
Diffusore a sfera in vetro bianco
soffiato e acidato. Cavi in acciaio
a lunghezza regolabile.





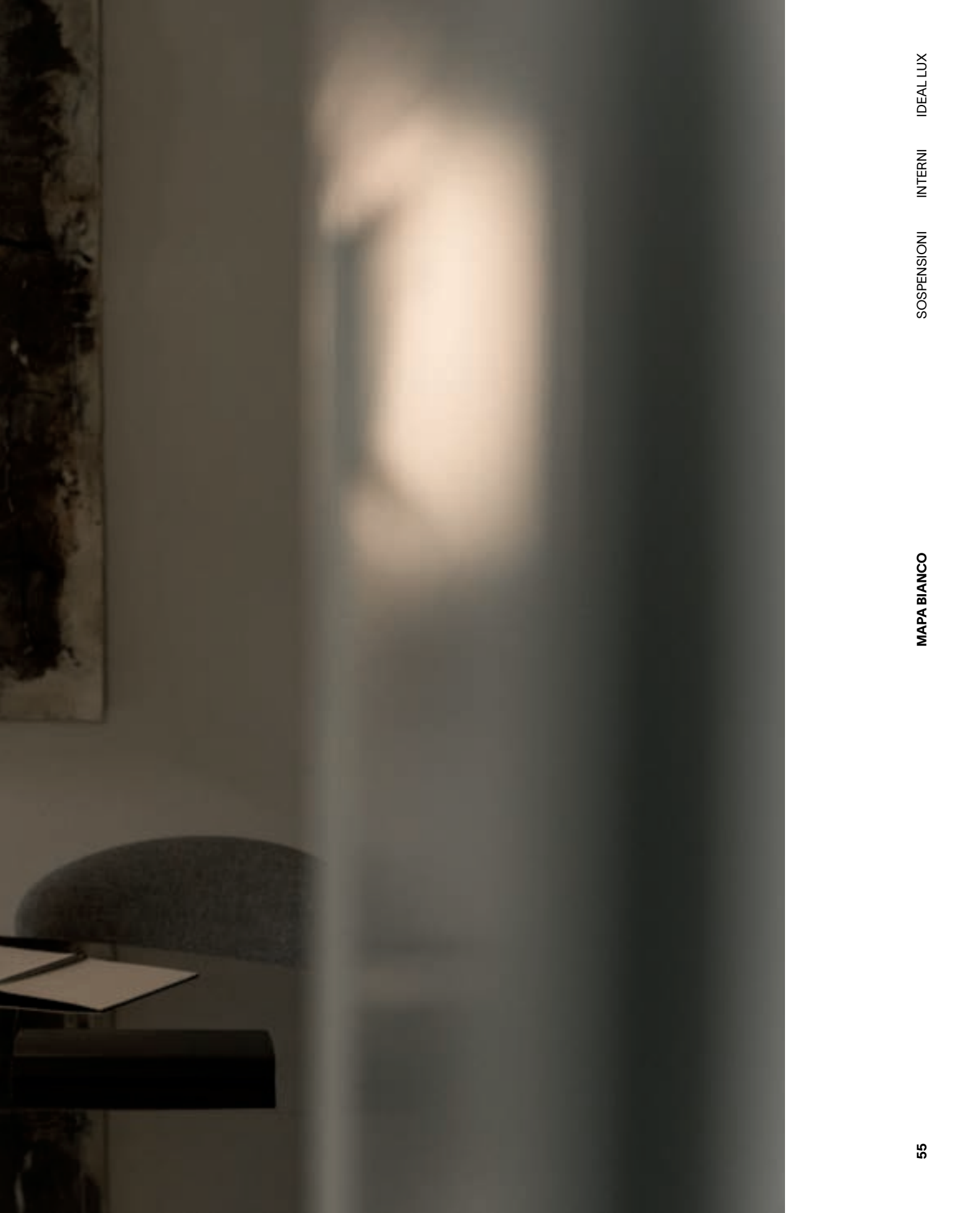



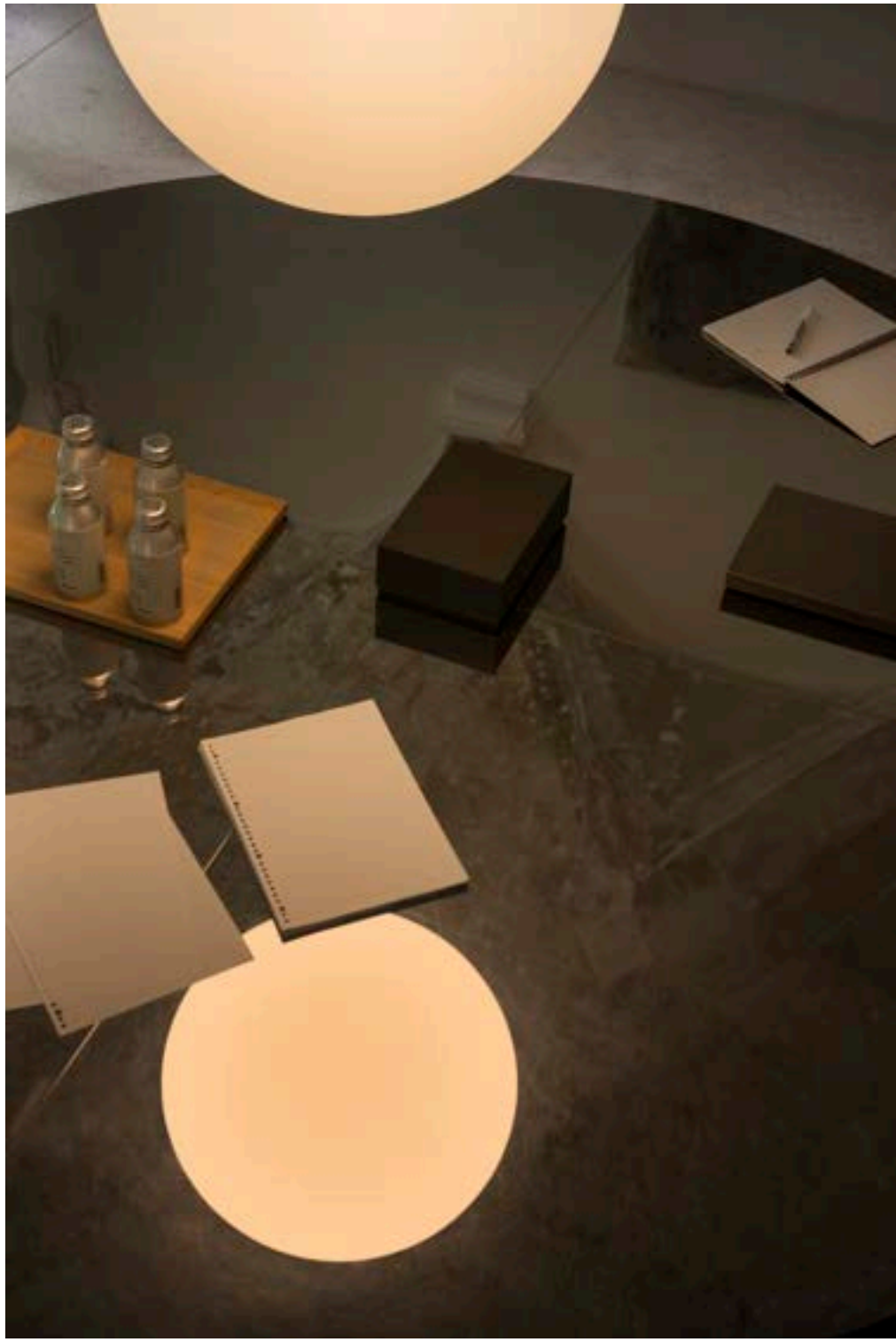



MINT

Montatura in metallo con finitura
ottone satinato e rosone nero
opaco. Cavo rivestito in tessuto.
Diffusore in vetro soffiato con
rigatura in rilievo. Disponibile
nelle finiture fumè o verde.









MIX UP

Rosone e paralumi intercambiabili
in metallo verniciato a polveri.
Cavo in PVC. Finiture: bianco
oppure nero.



IDEAL LUX

INTERNI

SOSPENSIONI

MIX UP























MOBY

Montatura e diffusore in metallo con interno bianco. Disponibile nelle finiture bianco, nero o rame.















NEMO

Diffusore in vetro soffiato. Disponibile in versione fumé, trasparente, rame o cromo sfumato.



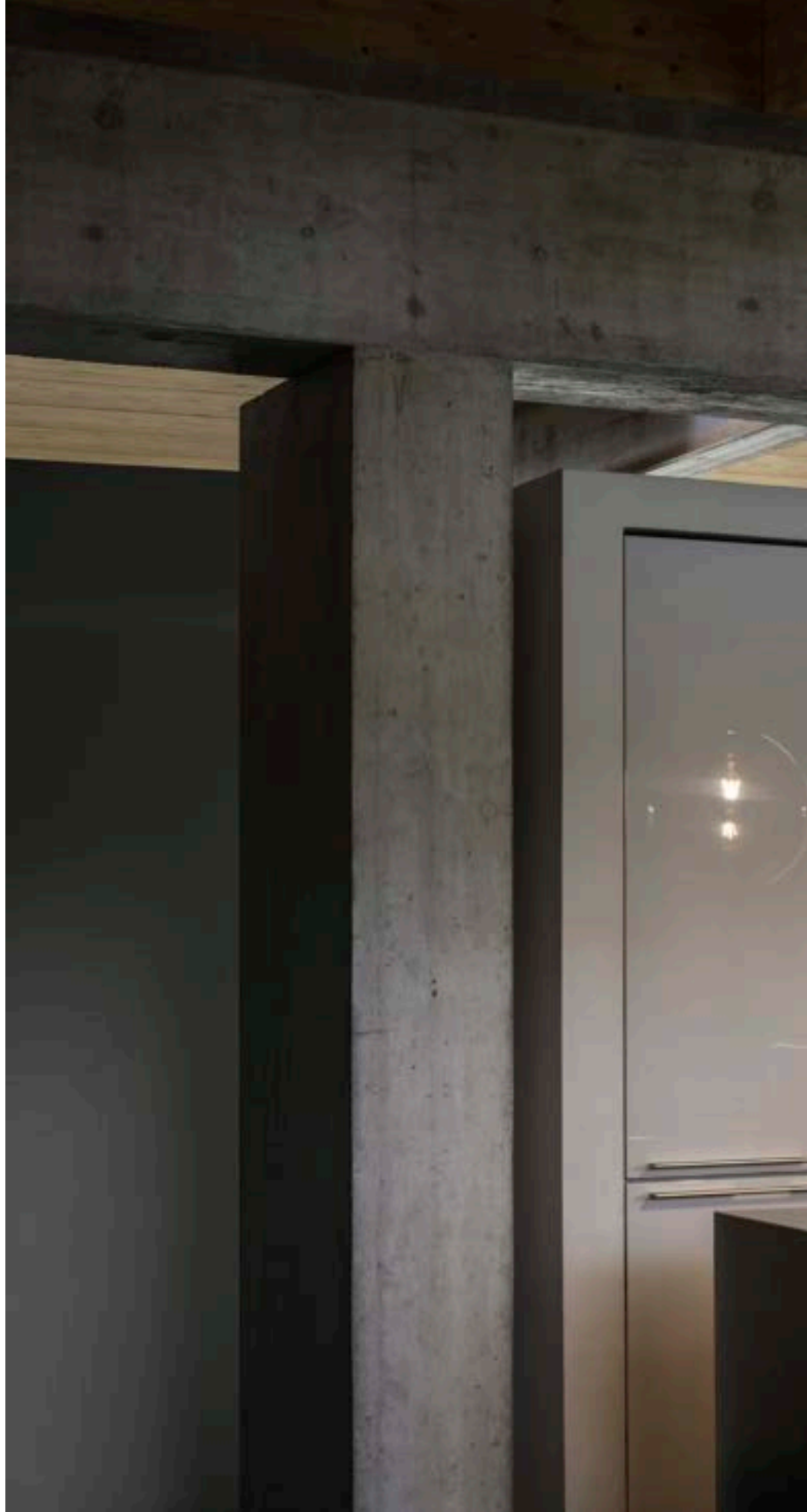









ONION

Struttura in metallo con finitura
in vernice marrone ad effetto
metallico. Cavo in tessuto.



















ORACLE SLIM

Lampada a sospensione costituita da una montatura sottile in alluminio verniciato bianco o nero opaco e diffusore opale in policarbonato. Disponibile in versione round (quattro dimensioni) e versione square (tre dimensioni).





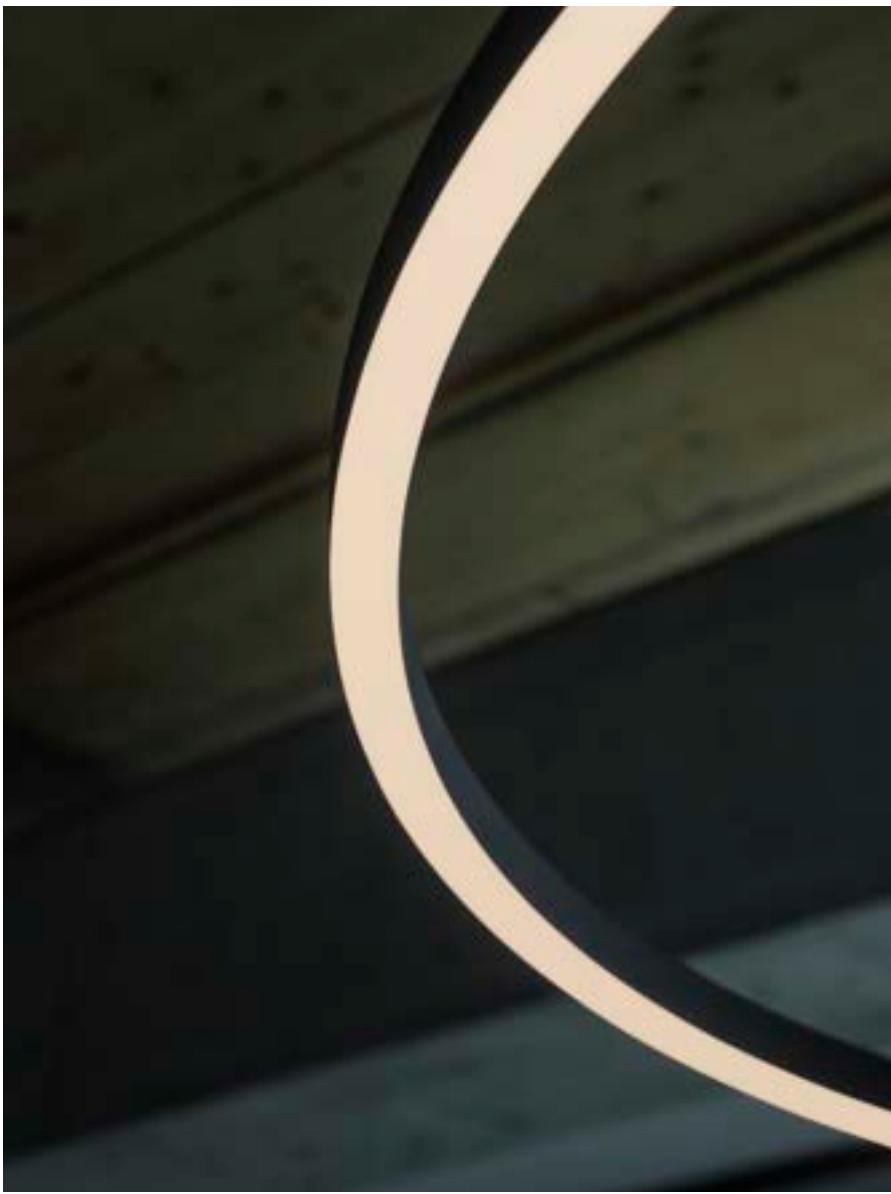





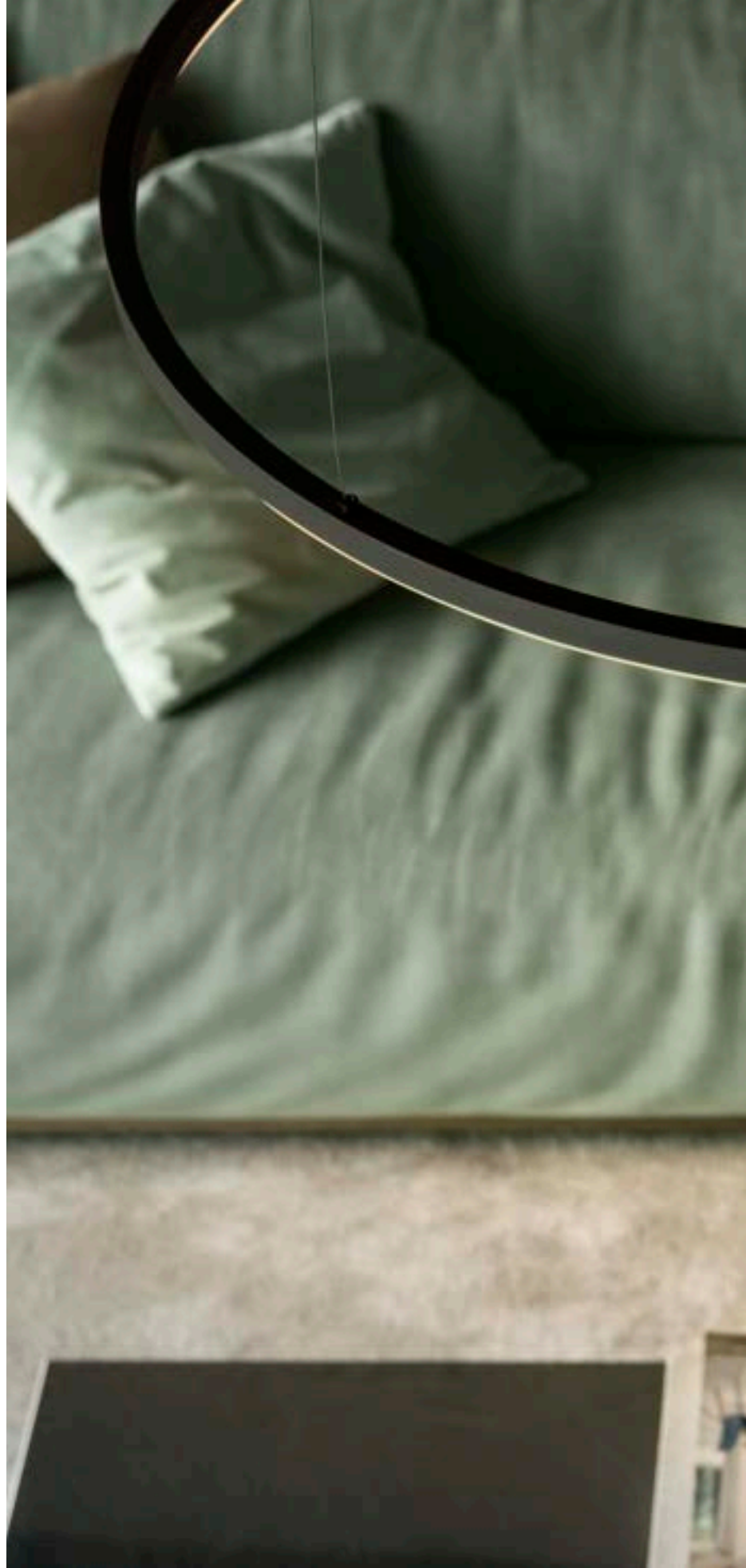



OZ



Base e montatura in metallo verniciato a polveri o placcato. Cavi in pvc. Diffusore in gomma opale. Finiture: bianco, nero o ottone spazzolato. Disponibile anche in versione dimmerabile DALI/Push.







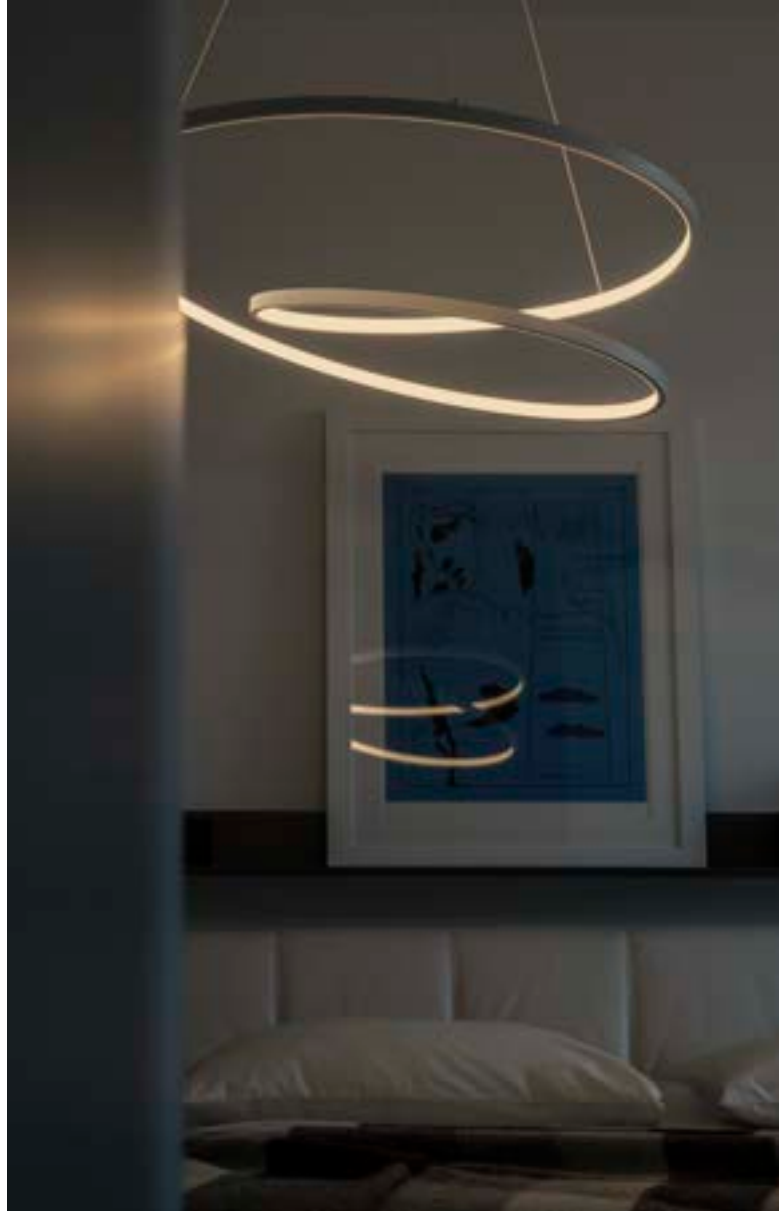





PERLAGE

Montatura in metallo con struttura lineare a sezione tonda o circolare a sezione quadrata. Diffusori in vetro soffiato. Cavi in acciaio gommati. Cavo elettrico in pvc. Finiture: nero opaco e vetri pirex fumé oppure ottone satinato con vetri bianchi acidati o con vetri ambra.













ULTRATHIN

Rosone e diffusore in metallo placcato cromo o rifinito con vernice opaca bianco o nero. Cavo elettrico in tessuto. Modello round nero disponibile anche in versione dimmerabile DALI/Push.





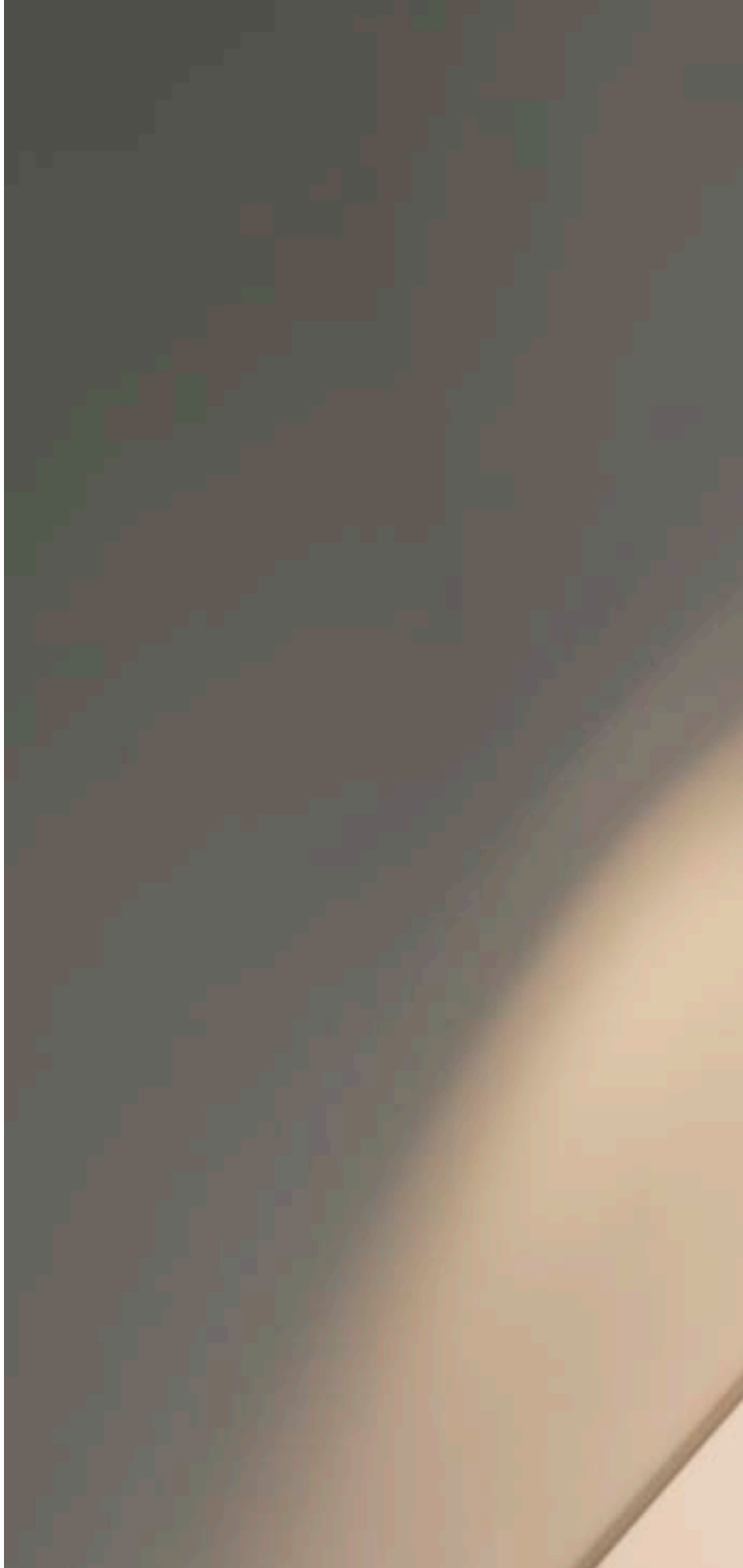



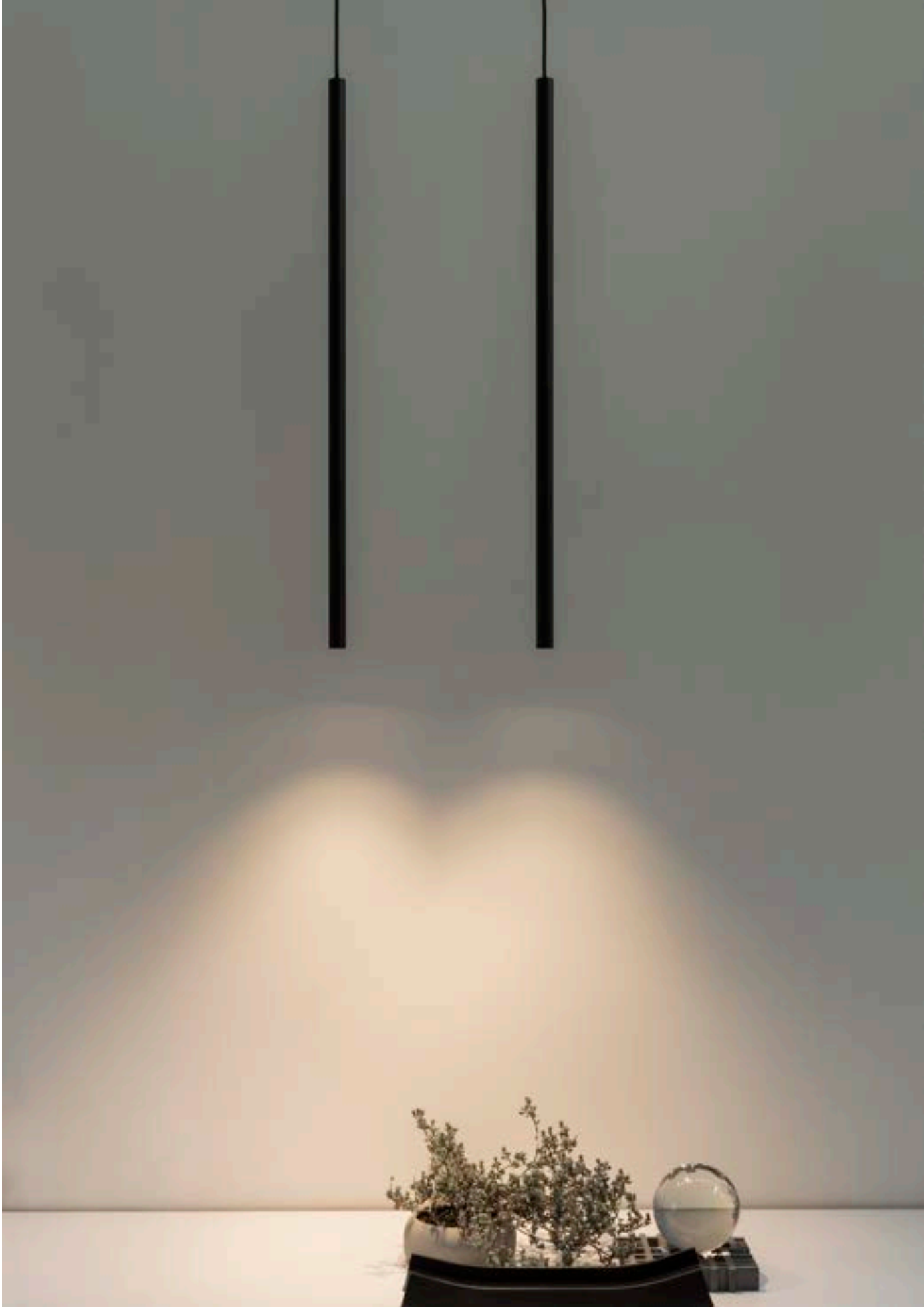





LAMPADE DA SOFFITTO

BAMBINI
CHE RIDONO,
CUCINA
IN SUBBUGLIO,
MANI
IMPASTATE,
SORRISI
SODDISFATTI,
DOLCE
PROFUMATO,
LAMPADE
ACCESE,
OMBRE
CHE BALLANO,
RICORDI
CHE SI FISSANO.



Indice

↳

122 **Birds**
126 **Dot**
130 **Dynamite**
136 **Fly**
142 **Frame**
146 **Spike**

SOLO SCHEDE TECNICHE

510	Gemini
511	Look
515	Mapa Bianco
518	Mix Up
523	Oracle Slim
524	Oz
528	Perlage
532	Set Up



BIRDS

Montatura in metallo verniciato con disco decorativo in ottone satinato. Diffusori in vetro soffiato bianco acidato. Colore: nero opaco con dettaglio ottone satinato.









DOT

Base e corpo luce e ghiera
in alluminio verniciato a polveri.
Diffusore in acrilico trasparente
satinato. Apparecchio per
installazione in superficie.
Finiture: bianco oppure nero.





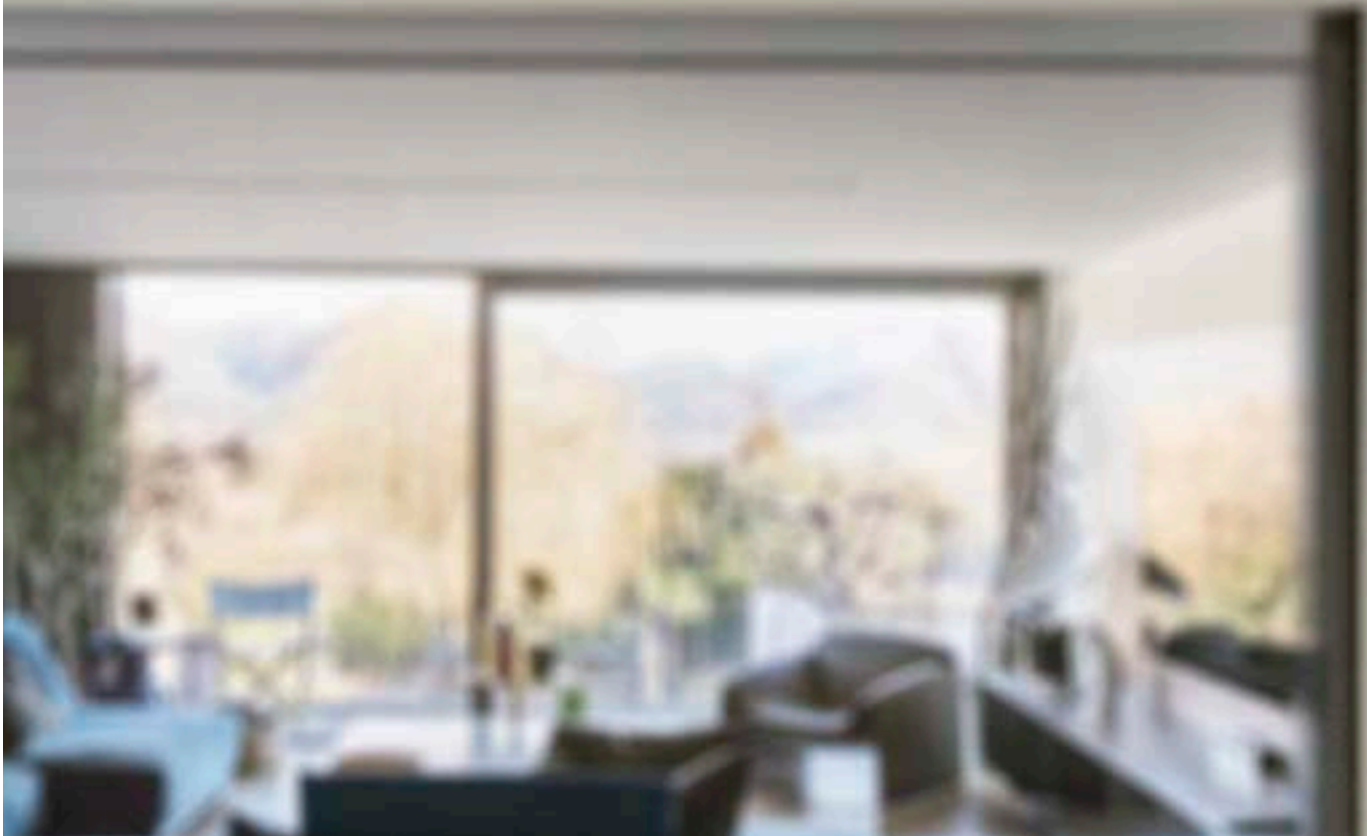



DYNAMITE

Montatura in metallo rifinito
con vernice a polveri o placcato
e spazzolato. Diffusori orientabili.













FLY

Famiglia di lampade a plafone con base circolare, disponibile in quattro diametri diversi (350 mm, 450 mm, 600 mm, 900 mm) oltre che nella variante SLIM dall'altezza più compatta. Corpo luce in alluminio verniciato a polveri in finitura bianco RAL 9016 e nero RAL 9004, ottica arretrata (FLY PL) oppure a filo (FLY SLIM) con diffusore in PMMA microprismatizzato con controllo dell'abbagliamento (UGR < 19). La lampada è predisposta per essere integrata con il modulo accessorio uplight (vedi pag. 141) per la componente di illuminazione indiretta.















FRAME

Base e montatura in metallo verniciato bianco opaco o nero opaco. Diffusori in materiale plastico colore opale. Emissione luce diretta.



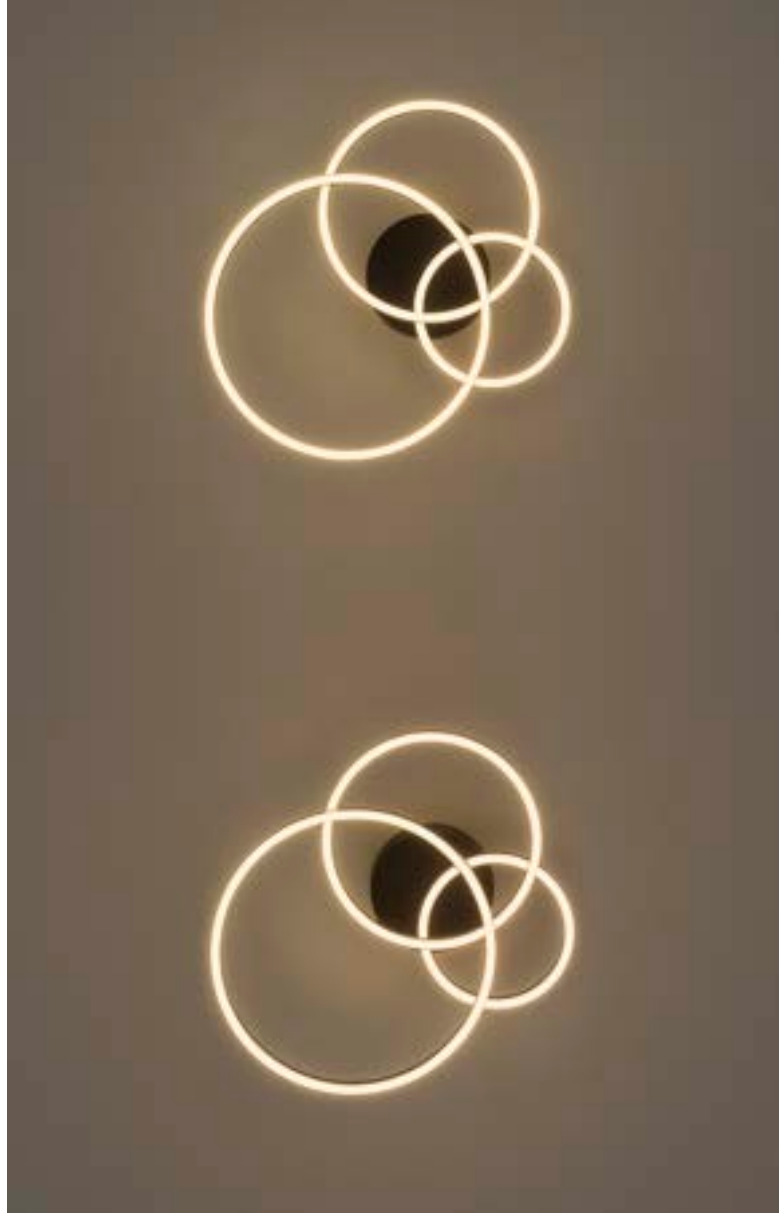





SPIKE

Corpo luce e base in alluminio tornito verniciato a polveri o placcato. Sorgente luminosa a led sostituibile. Colori: bianco, cromo, nickel, nero, ottone satinato oppure rame brunito.







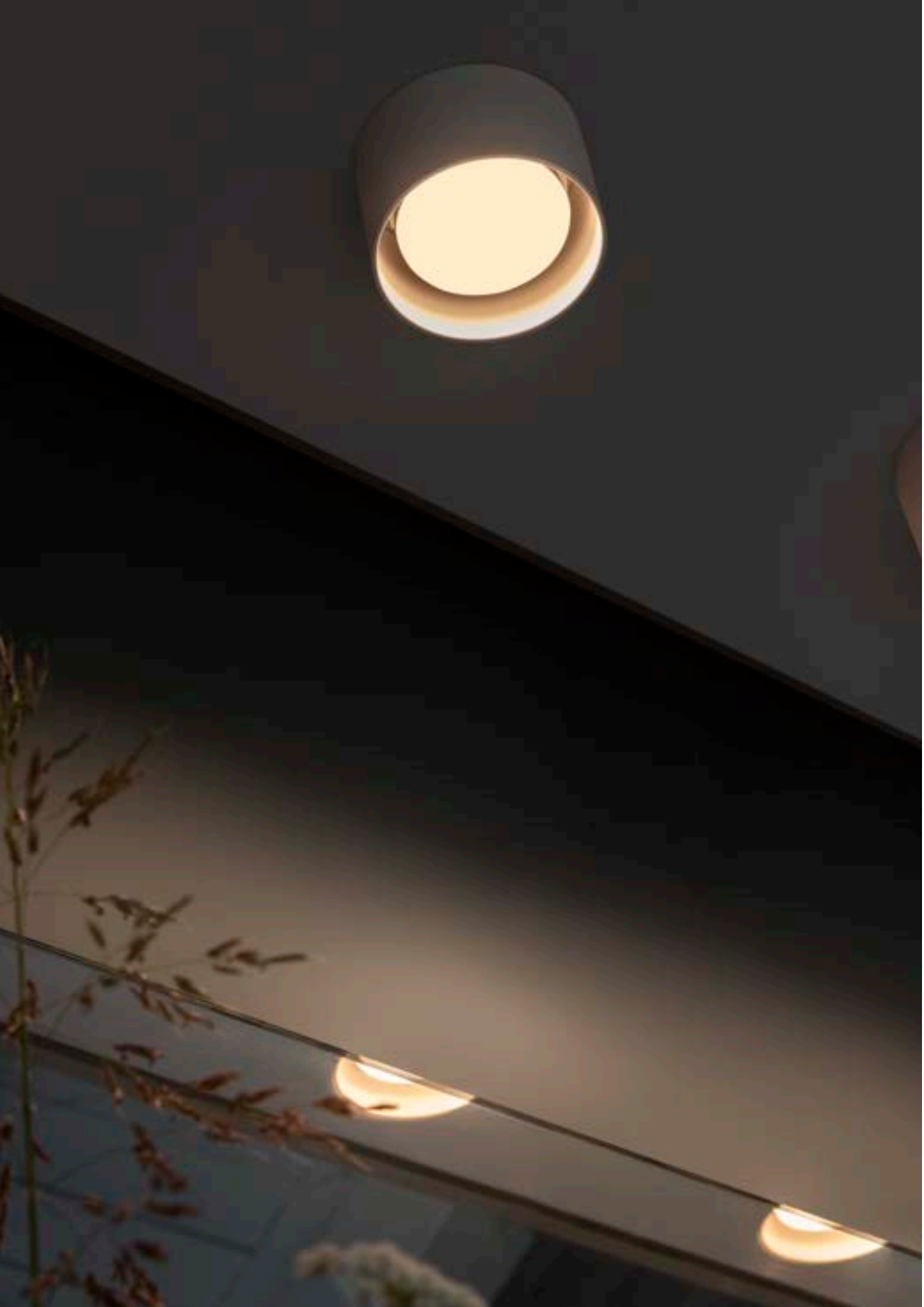



LAMPADE DA PARETE

SOGNI
CHE DANZANO,
PAGINE APERTE,
LUCE
GENTILE,
PAROLE CHE
FLUTTUANO,
ABBRACCI
NOTTURNI,
SILENZIO
CHE CULLA,
NOTTE
CHE ASCOLTA,
STORIE CHE
S'INTRECCIANO,
SOGNI CHE
S'INNALZANO.



Indice

↳

152 **Bean**
156 **Clip**
160 **Cover**
166 **Delta**
172 **Essence**
178 **Focus**
182 **Piano**
186 **Set Up**
190 **Zig Zag**

SOLO SCHEDE TECNICHE 489 **Birds**
497 **Equinoxe**
500 **Filo**
588 **Linus**
512 **Look**
515 **Mapa Bianco**
525 **Oz**
530 **Perlage**



BEAN

Base e diffusore orientabile
in metallo placcato o verniciato
a polveri. Colori bianco, nero
oppure ottone o nickel
con interruttore e snodo neri.











CLIP

Corpo luce interamente in lamina di metallo con varie finiture. Nella versione piccola, diffusori in vetro pirex sabbato.



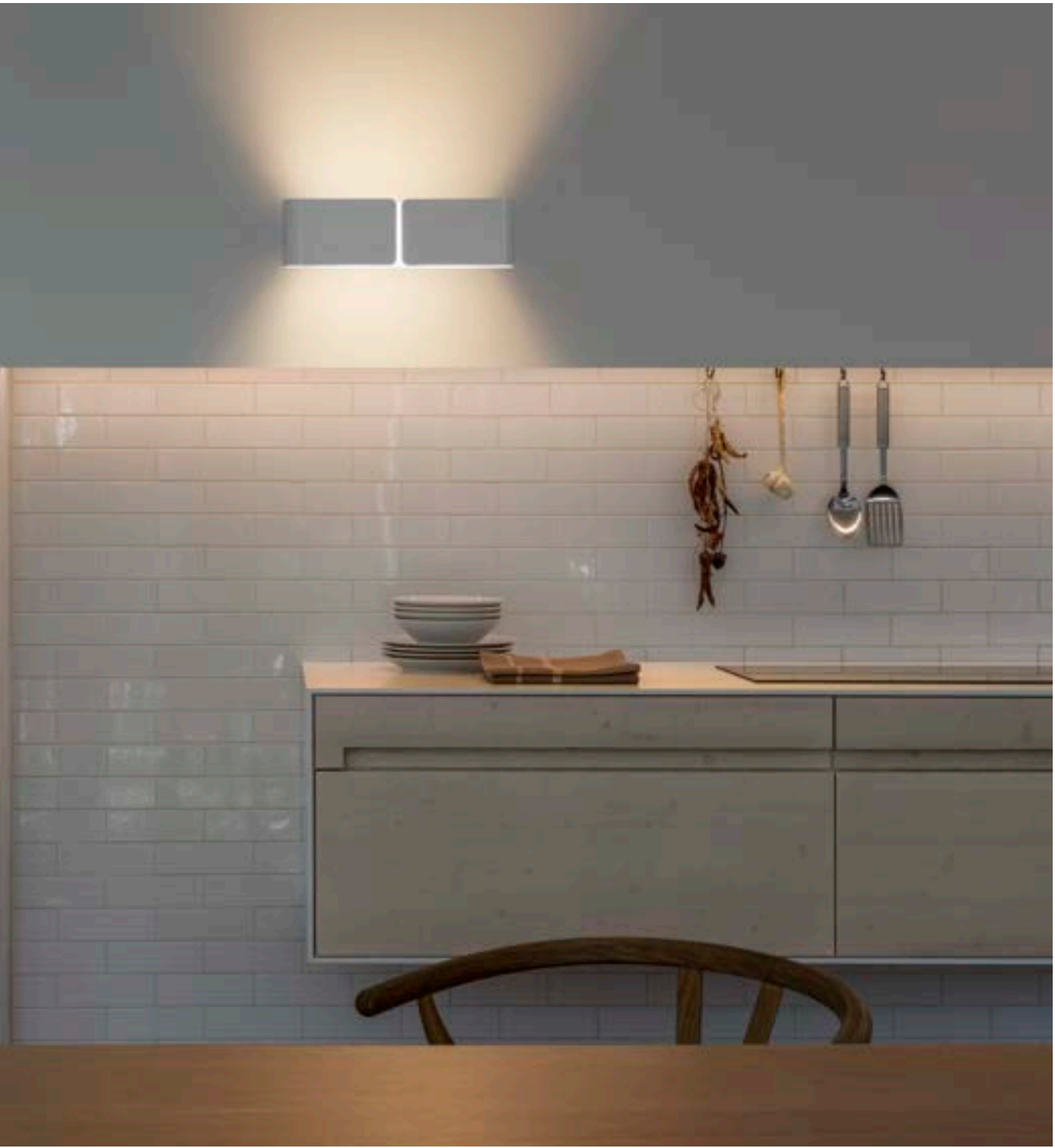







COVER

Corpo luce in alluminio verniciato a polveri di colore bianco o nero. Diffusore in materiale plastico opale. Sorgente luminosa a led integrati con emissione di luce riflessa.

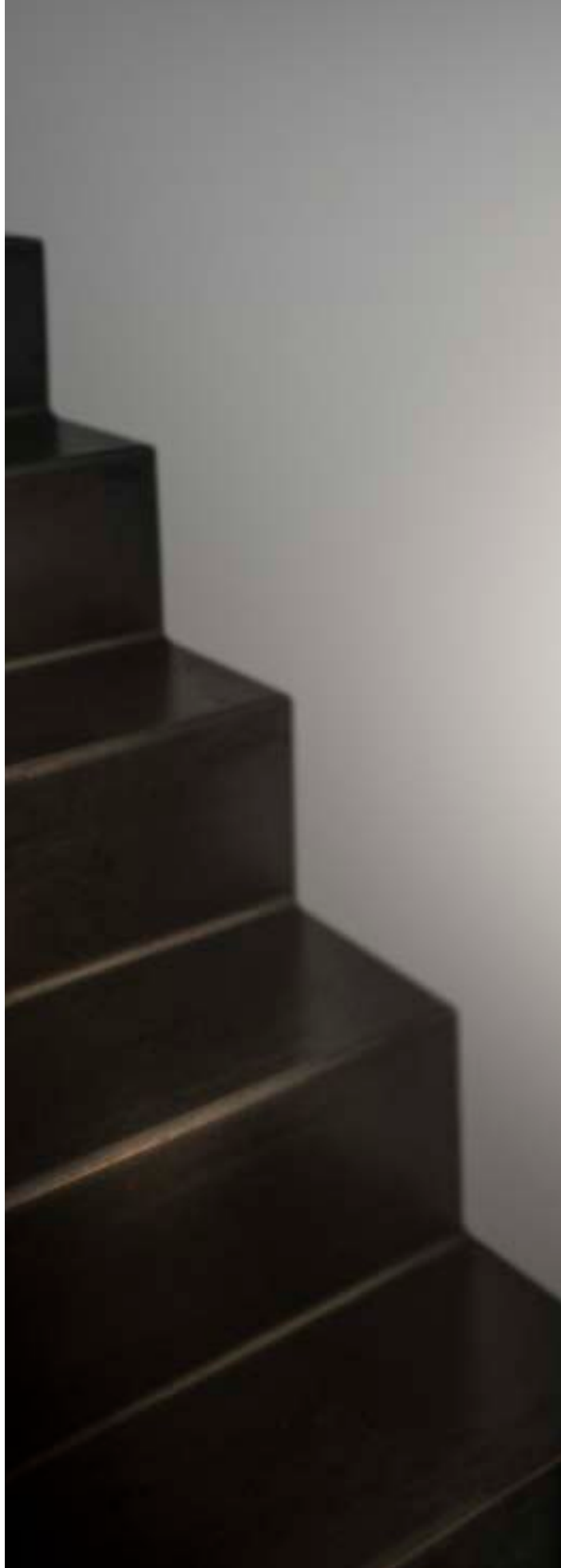













DELTA

Corpo luce in alluminio verniciato a polveri. Diffusori in policarbonato opale lucido. Emissione luce sopra e sotto. Finiture: bianco oppure nero.







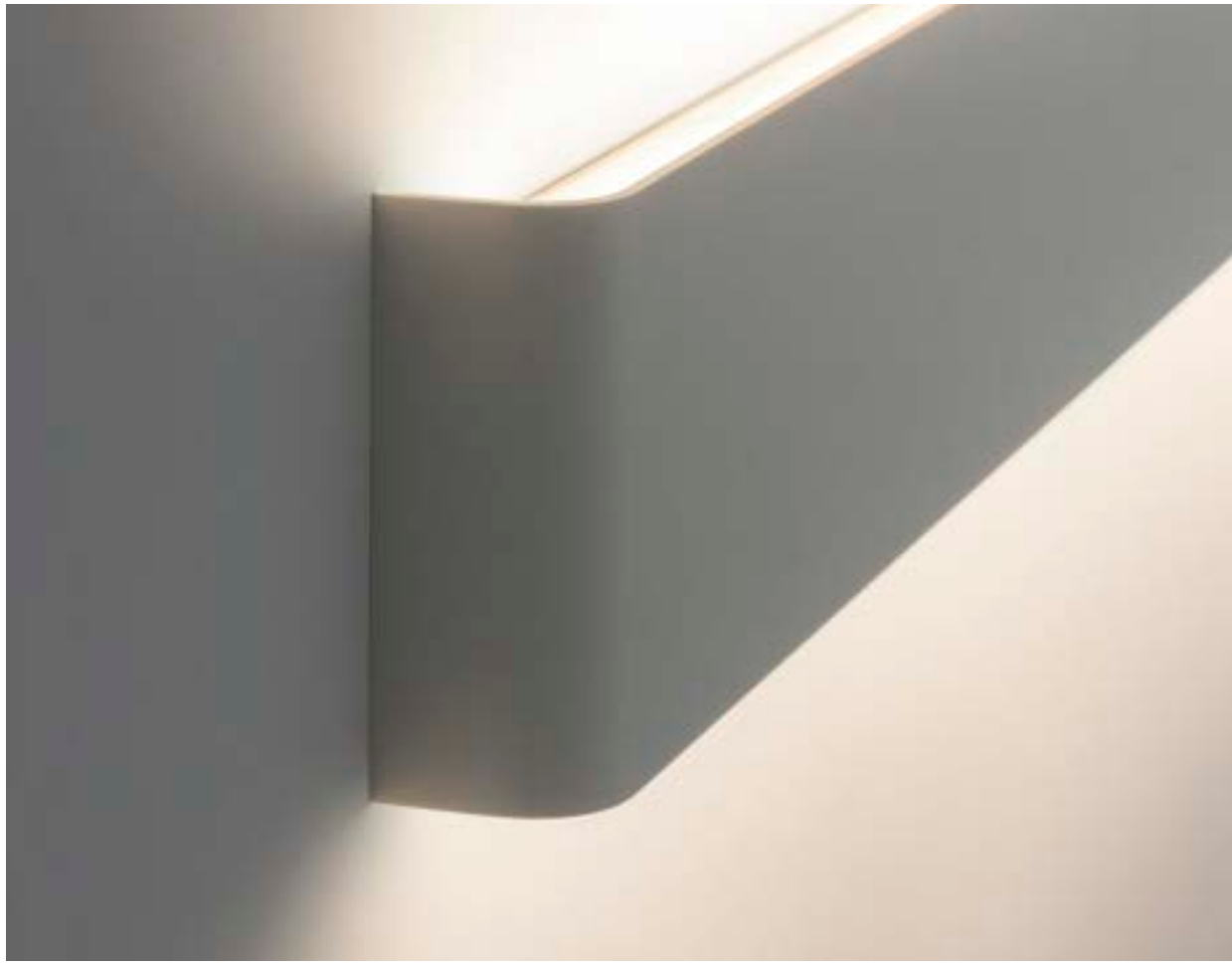

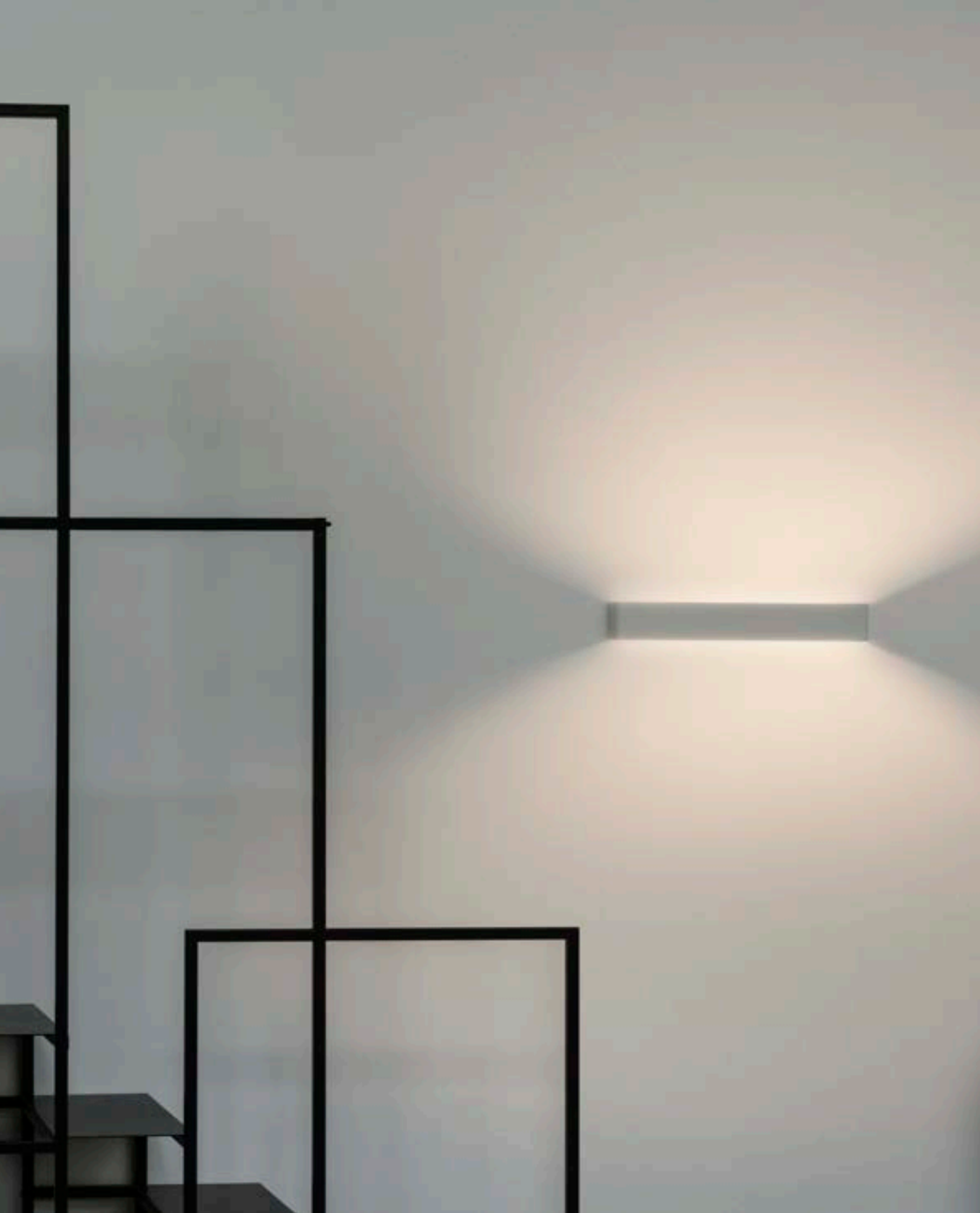





ESSENCE

Base e corpo luce in alluminio verniciato a polveri.
Diffusore in materiale acrilico opale. Emissione luce indiretta.
Colori: bianco o nero.

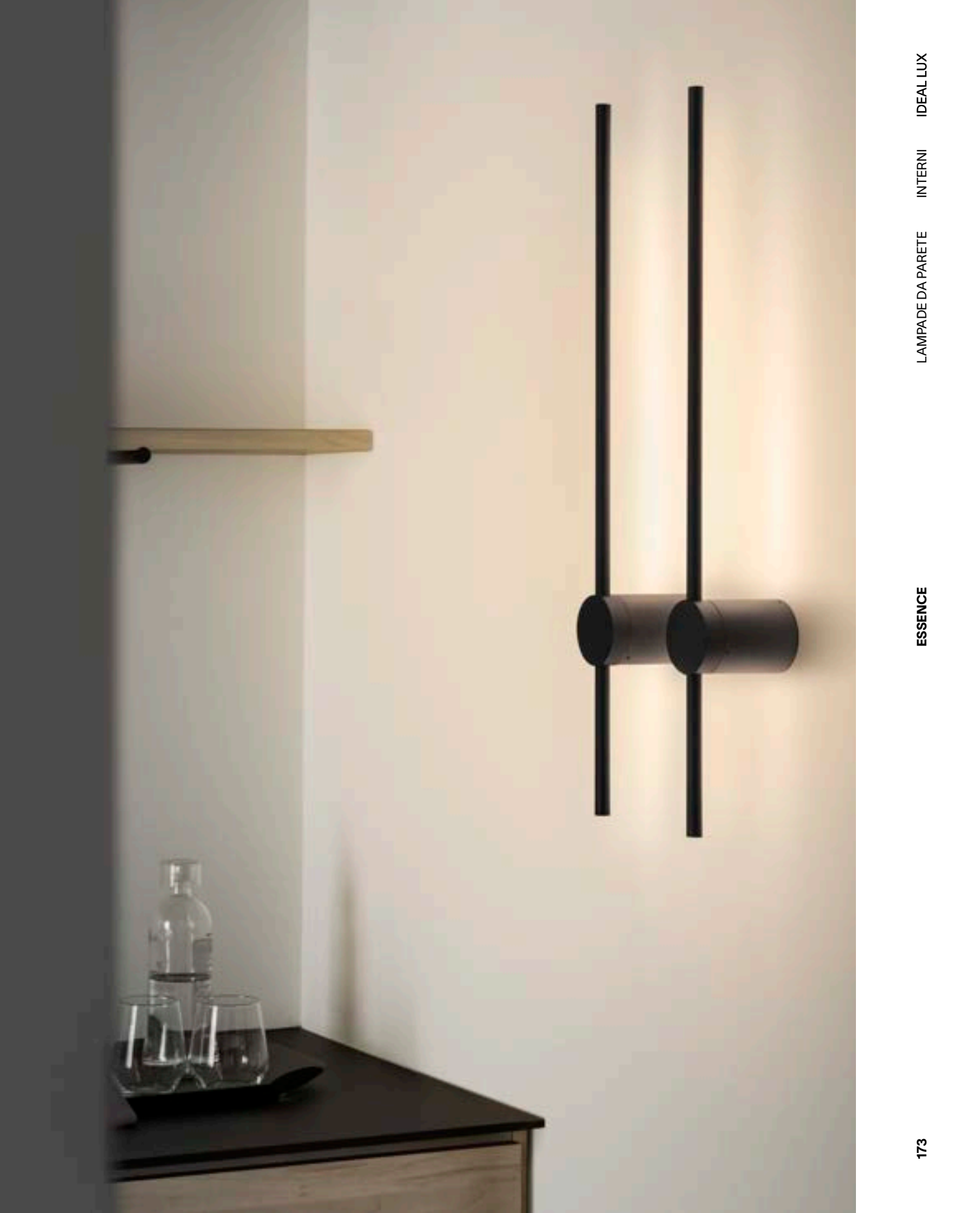











FOCUS

Corpo luce in metallo con braccio flessibile orientabile rivestito in gomma. Rifinito in bianco o in nero opaco oppure in grigio con dettagli in cromo.









PIANO

Montatura interamente in alluminio verniciato a polveri. Diffusore in policarbonato opale con emissione sul retro. Proiettore frontale orientabile. Colore: bianco o nero.





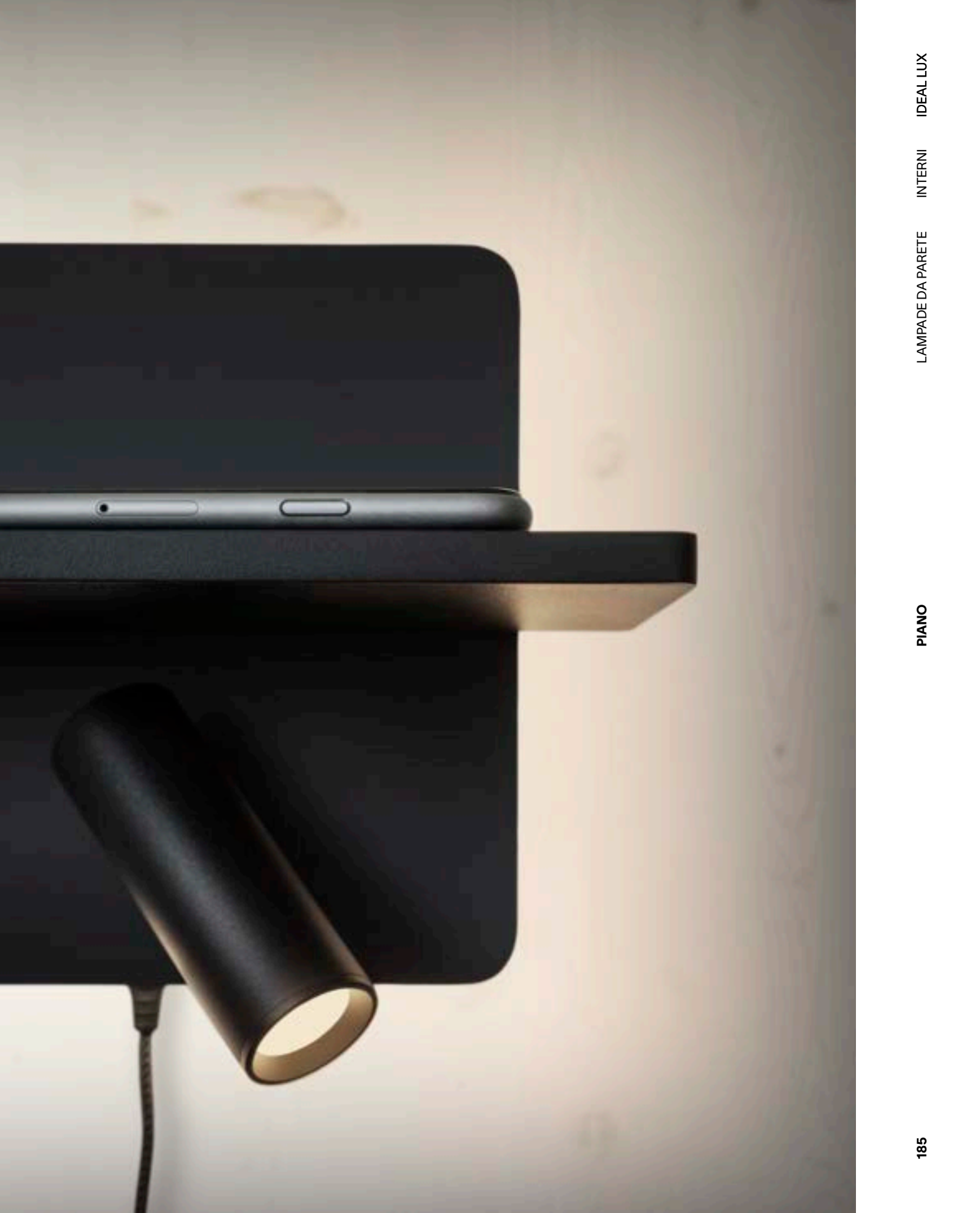



SET UP

Montature in metallo verniciato a polveri o placcato. Applique a due luci con braccio flessibile rivestito in gomma, interruttori indipendenti e presa USB. Paralumi in pvc ignifugo rivestito di tessuto. Colori montature: bianco, nero oppure nichel satinato o ottone spazzolato con dettagli neri. Colori paralumi: beige, tortora, bianco o nero.











ZIG ZAG

Corpo luce dissipatore interamente in lastra d'alluminio da 6 mm di spessore. Rifinito con vernice a polveri di colore bianco, nero o placcato ottone, cromo oppure rame. LED integrati.



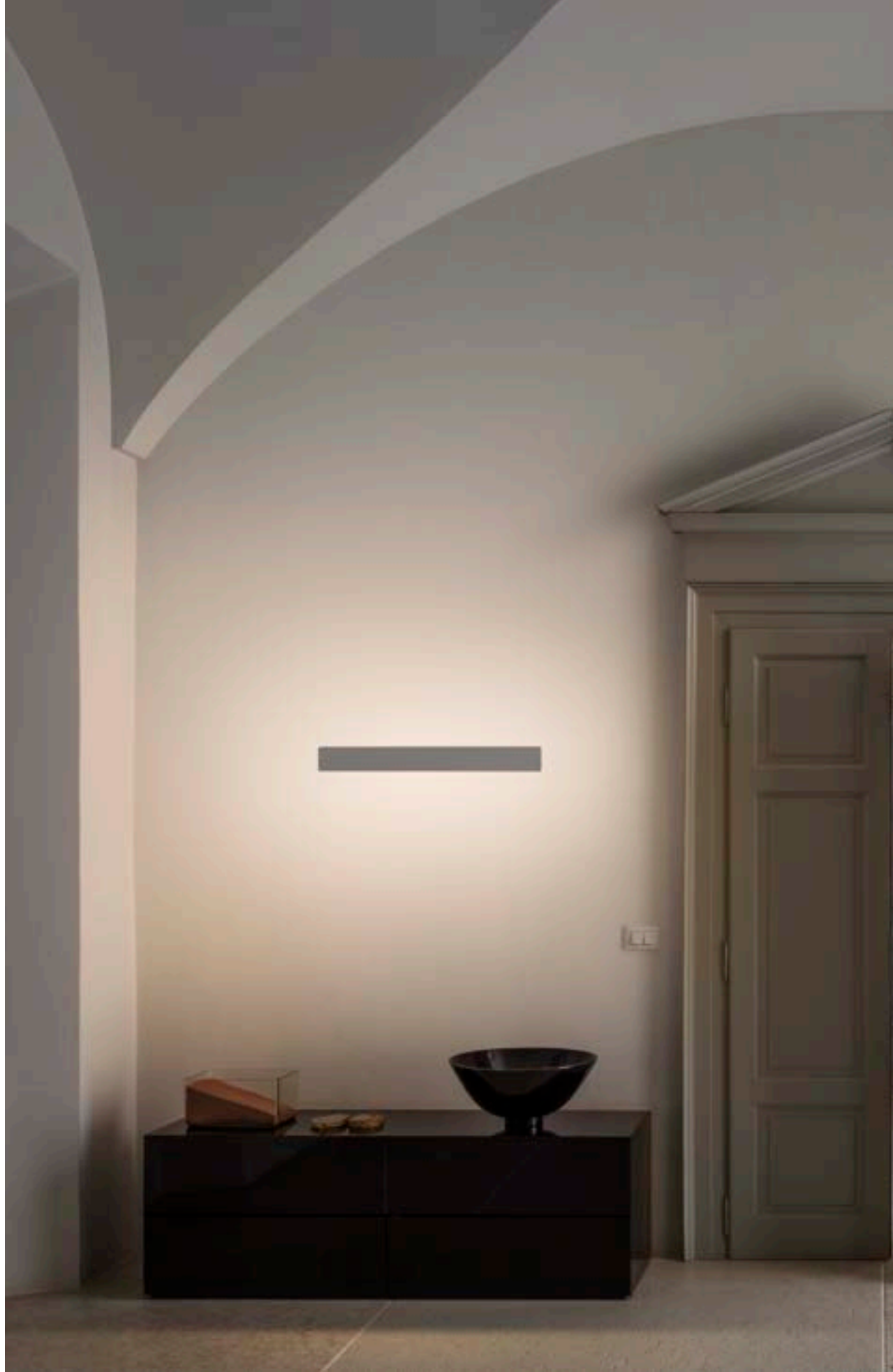







LAMPADE DA TAVOLO

APPUNTI
SCARABOCCHIATI,
IDEE
GERMOGLIATE,
LUCE
ATTENTA,
CHE ISPIRA.
IDEE
ILLUMINATE,
CONCENTRAZIONE
COSTANTE.
PENSIERI
FLUIDI,
CHE DANZANO.





Indice

↳

198 **Futura**
204 **Mapa Bianco**
210 **Oz**
218 **Pivot**
224 **Set Up**
230 **Yoko**

SOLO SCHEDE TECNICHE

489 **Birds**
492 **Diesis**
501 **Filo**
530 **Perlage**



FUTURA

Braccio in alluminio e plastica,
snodato con cavo a vista in pvc.
Diffusore orientabile a led
e interruttore incorporato.
Spina con alimentatore.



IDEAL LUX

INTERNI

LAMPADE DA TAVOLO

FUTURA







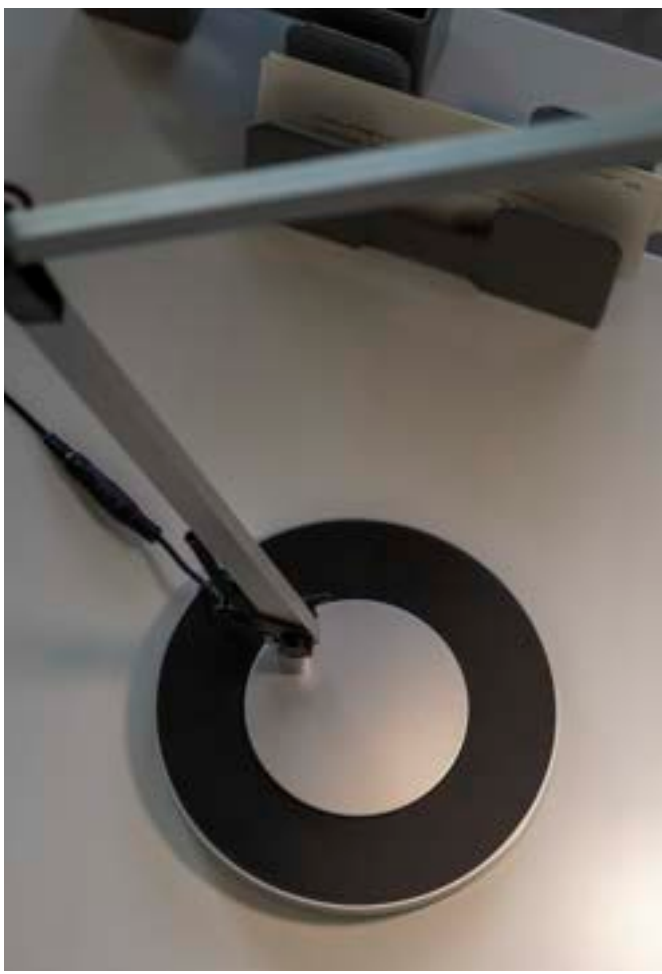

MAPA BIANCO

Base e sistema di fissaggio
in metallo bianco. Diffusore a sfera
in vetro bianco soffiato e acidato.







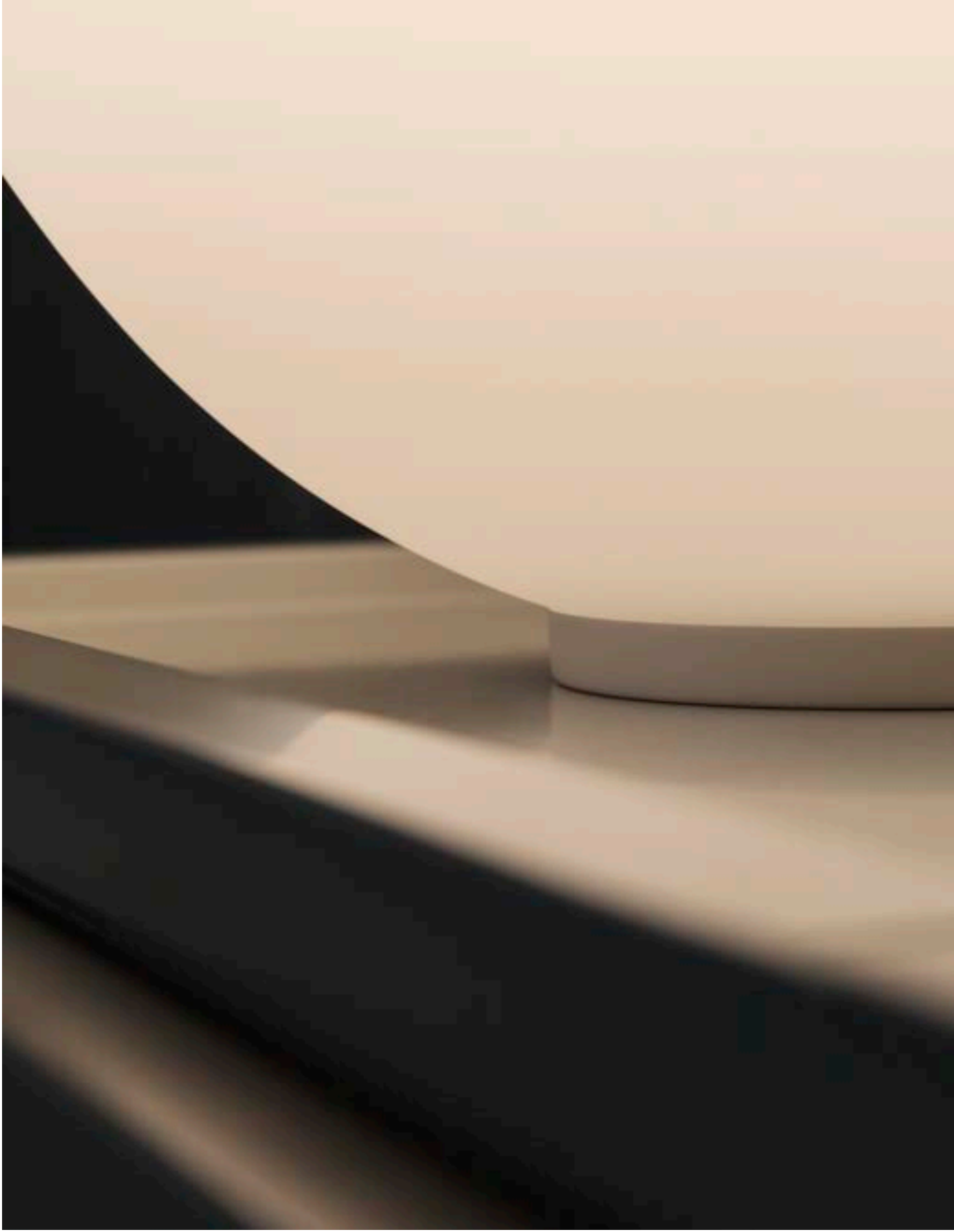

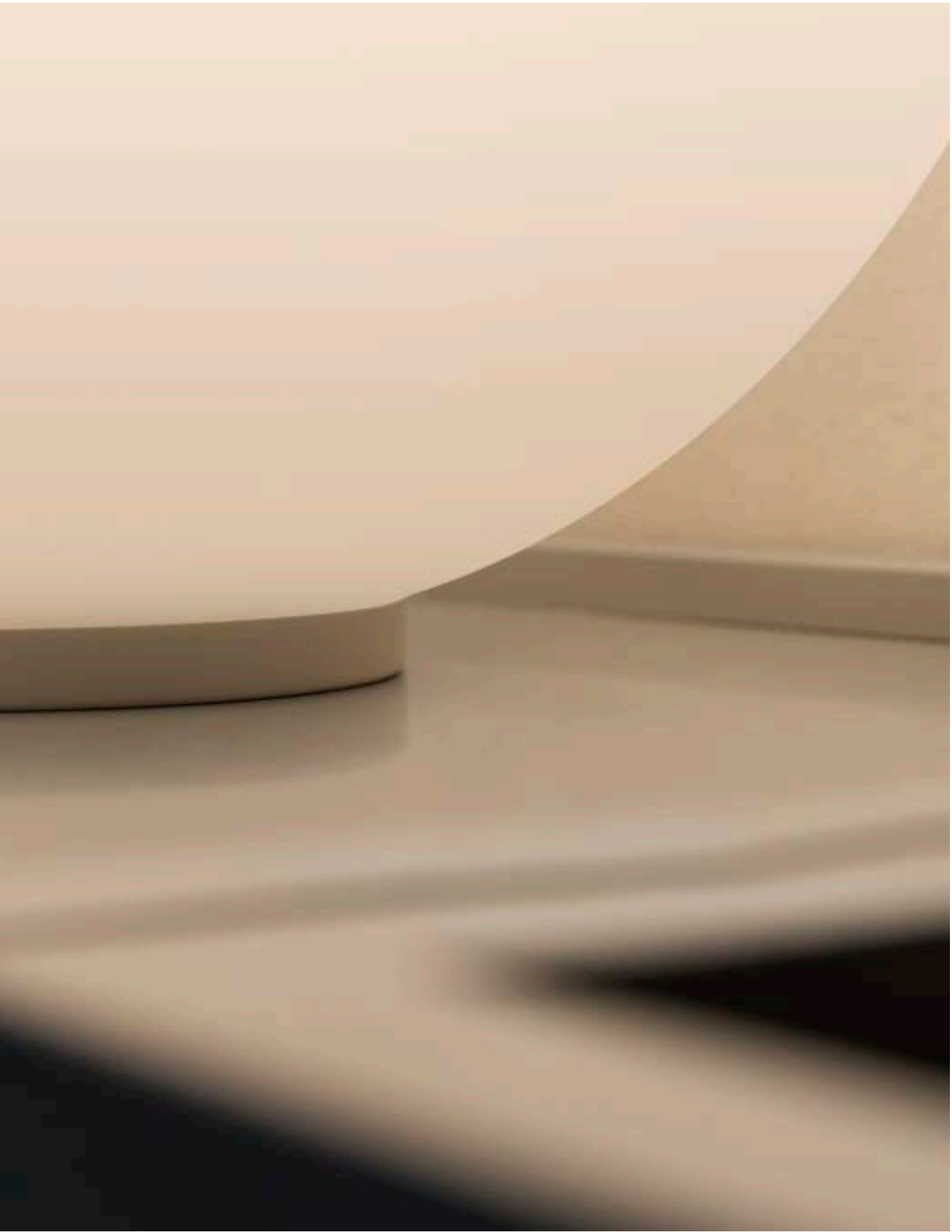

OZ

Base e montatura in metallo verniciato a polveri o placcato. Cavi in pvc. Diffusore in gomma opale. Disponibile nelle finiture bianco, nero o ottone spazzolato.

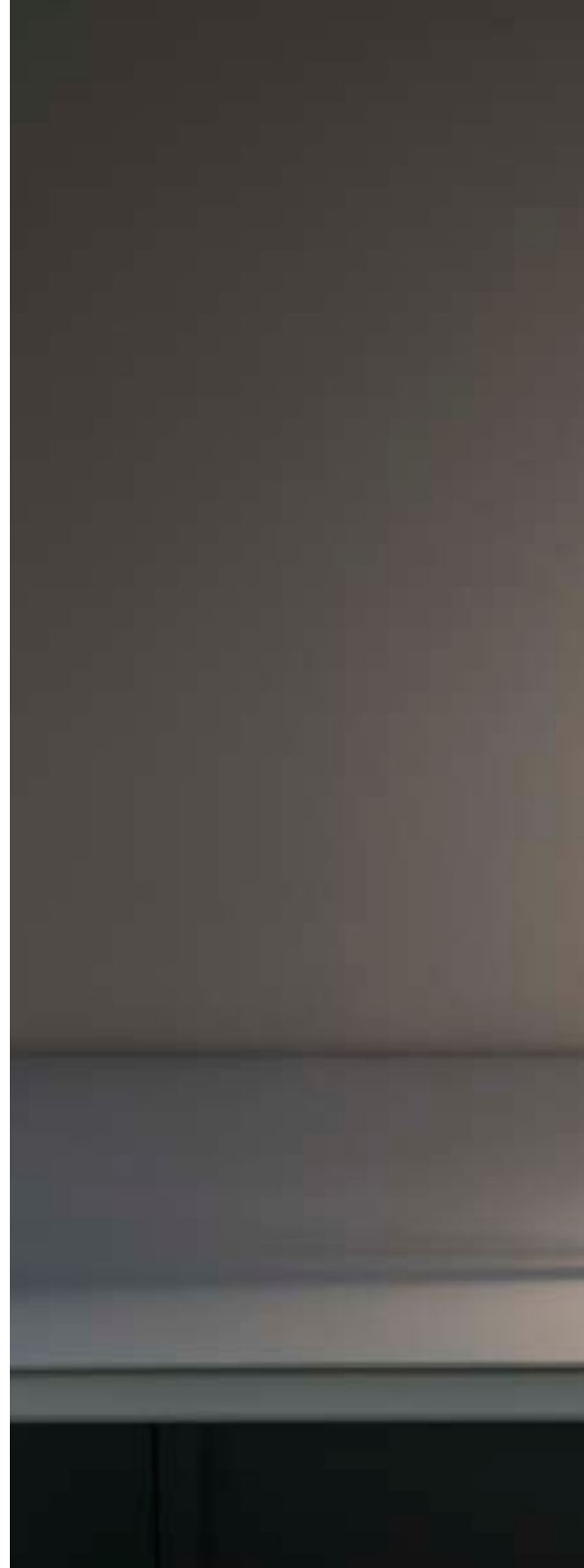









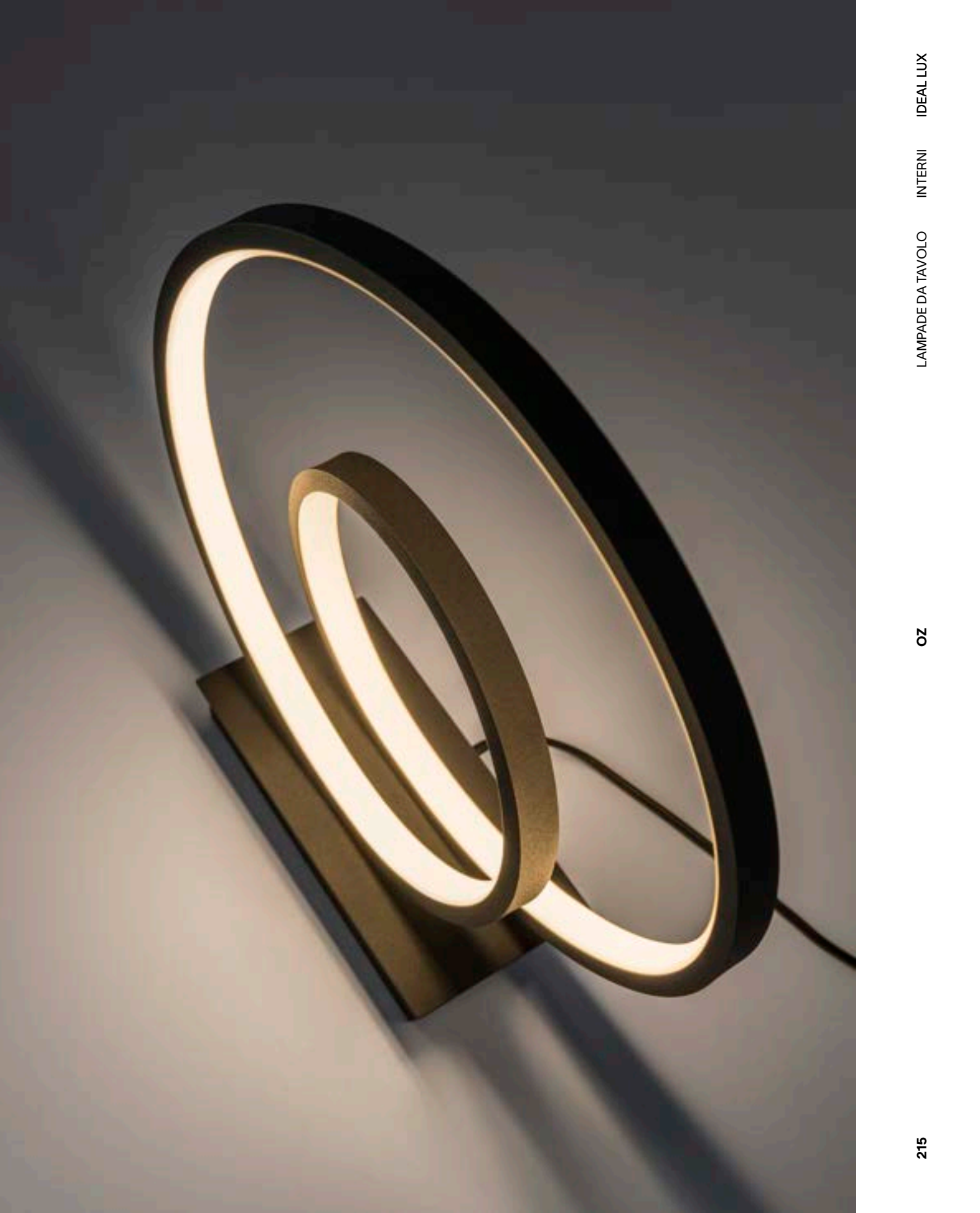







PIVOT

Montatura in alluminio verniciato opaco. Base rivestita in plastica con dimmer. Diffusore orientabile con schermo in PC opale satinato. Cavo in PVC con driver e spina.



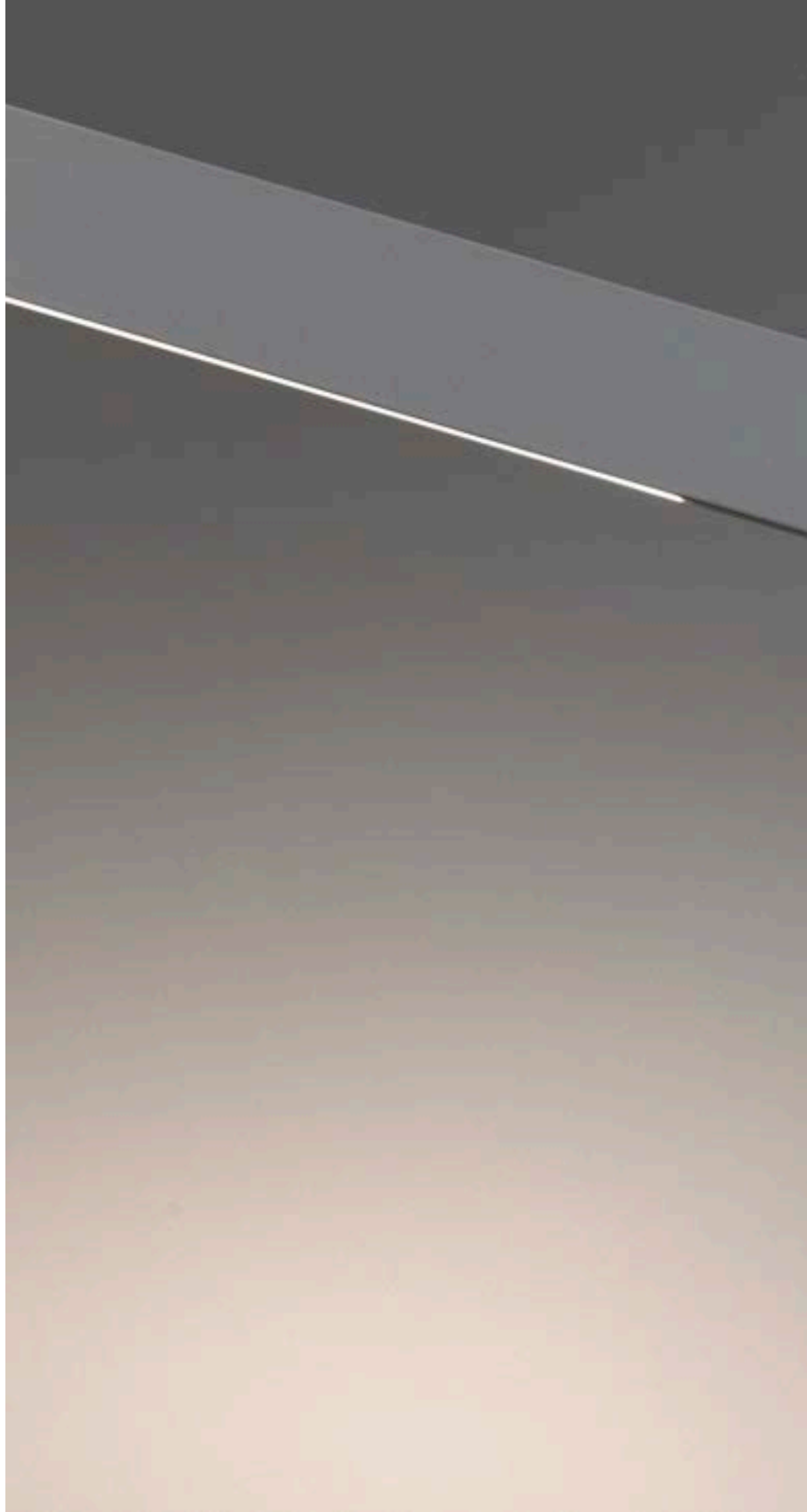

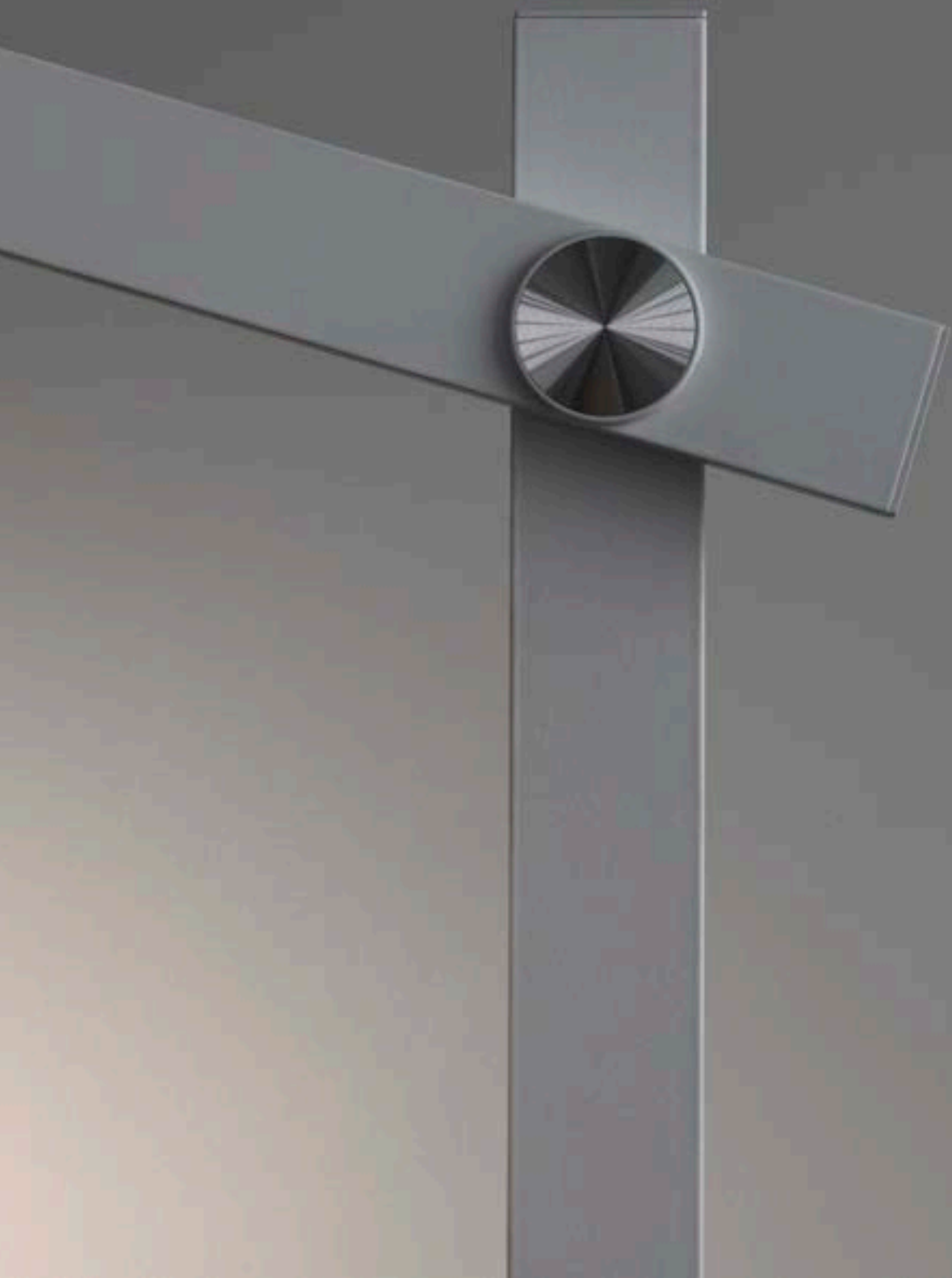







SET UP

Montature in metallo verniciato a polveri o placcato. Paralumi in pvc ignifugo rivestito di tessuto. Colori montature: bianco, nero oppure nickel satinato o ottone spazzolato. Colori paralumi: beige, tortora, bianco o nero.

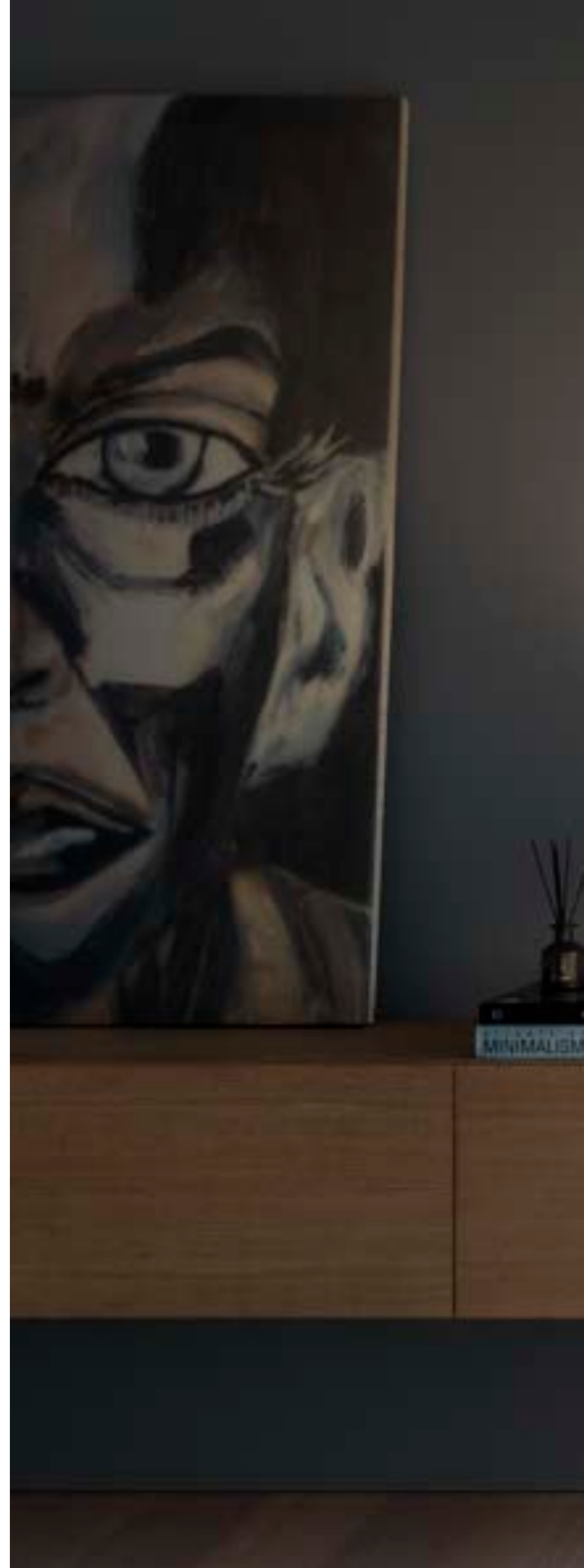



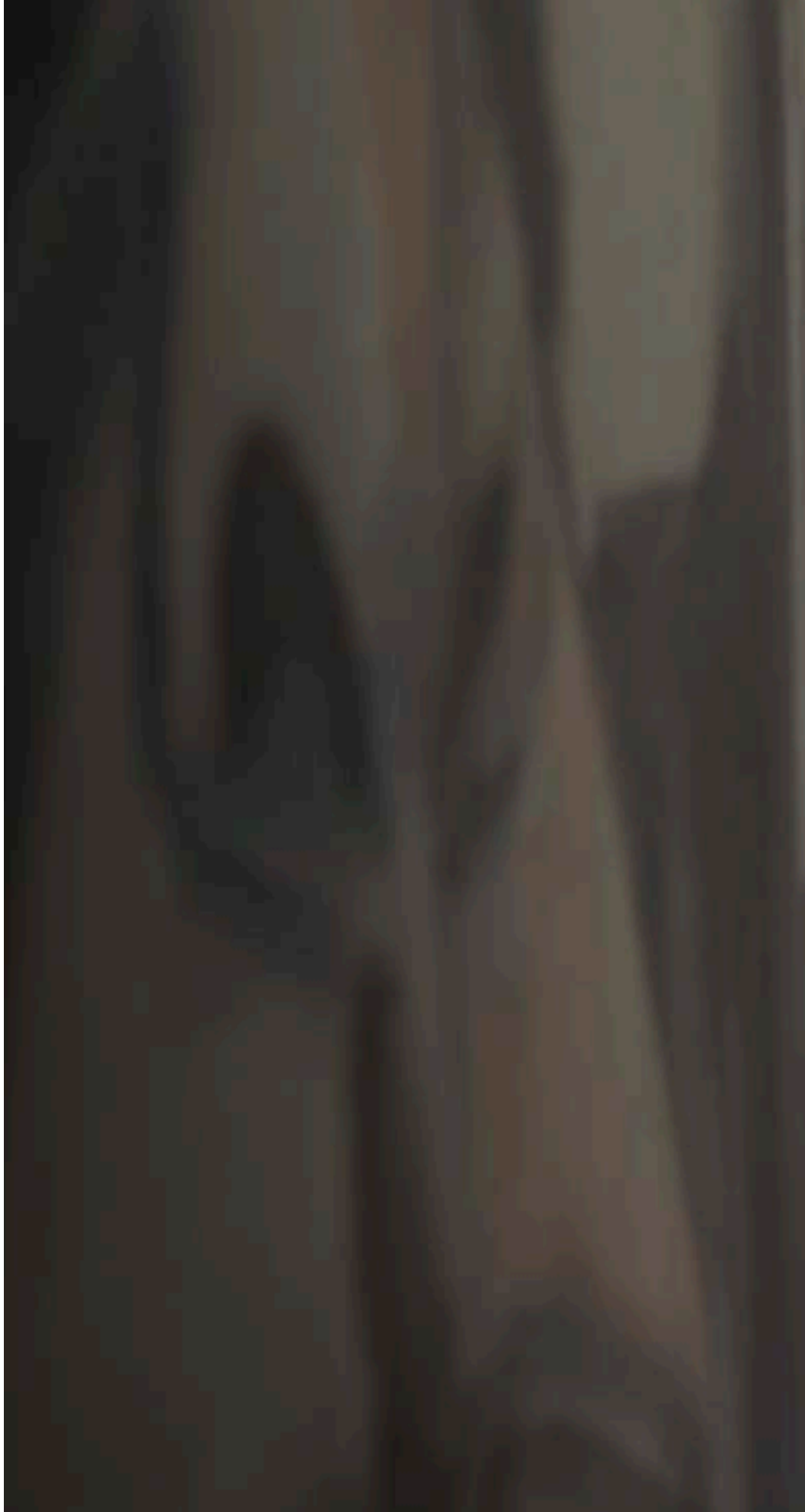







9905



YOKO

Base e montatura in metallo
verniciato opaco.
Diffusore in policarbonato opale.
Cavo in pvc con presa-alimentatore.
Colori: bianco o nero.









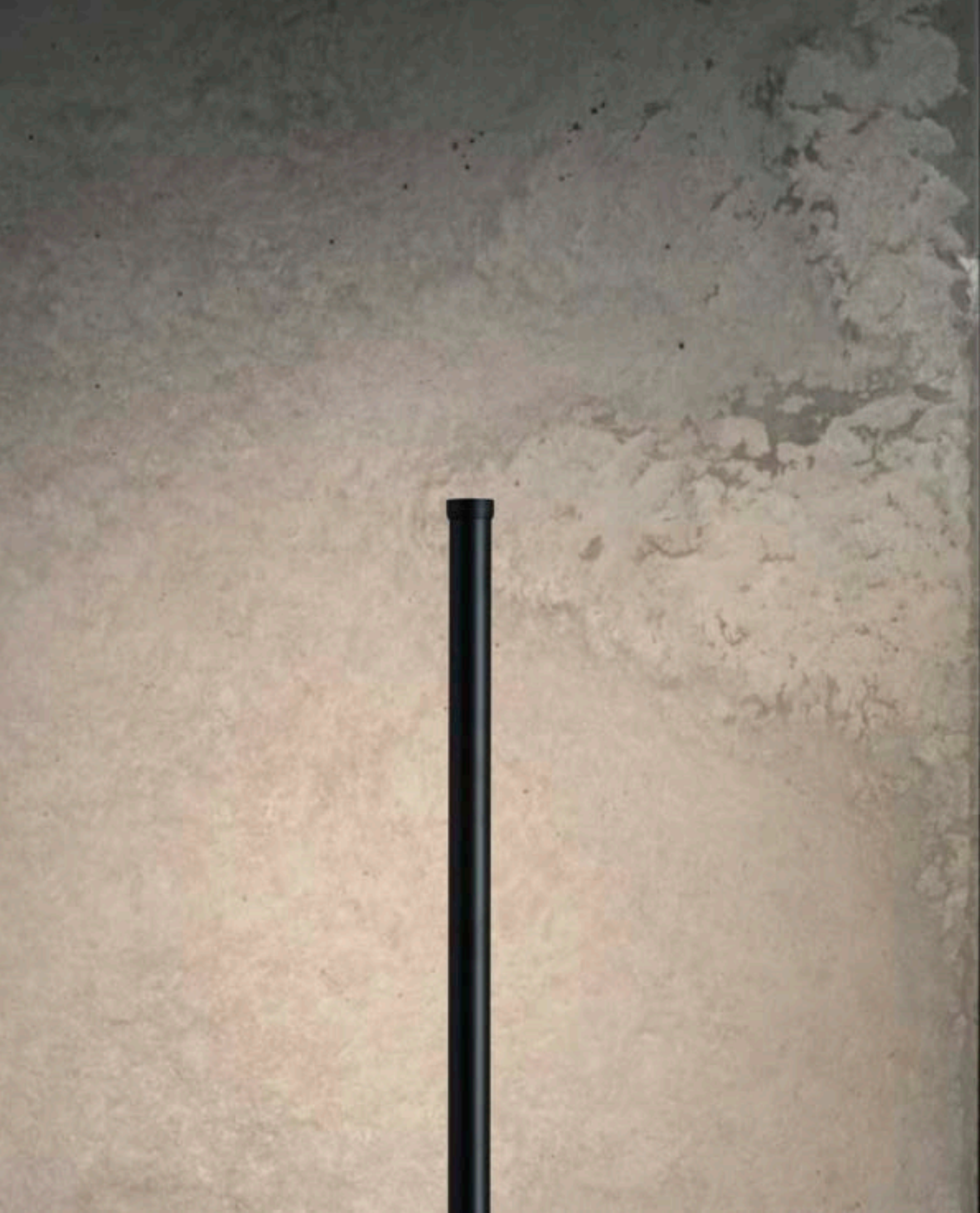



LAMPADE DA TERRA

PASSI
CHE RISUONANO,
CASA
CHE ASPETTA.
LUCE
CHE ABBRACCIA.
LA CALMA
SI DIFFONDE,
IL RIPOSO
SI FA CONFIDENZA,
I RICORDI
DANZANO
NELL'ARIA.





Indice



238 **Birds**
244 **Diesis**
252 **Dorsale**
258 **Equinoxe**
264 **Filo**
270 **Perlage**
276 **Set Up**
280 **Yoko**

SOLO SCHEDE TECNICHE

508	Frame
508	Futura
512	Look
518	Mix Up



BIRDS

Montatura in metallo verniciato con disco decorativo in ottone satinato. Diffusori in vetro soffiato bianco acidato. Cavo in pvc con interruttore e spina. Colore: nero opaco con dettaglio ottone satinato.















DIESIS

Montatura in metallo verniciato a polveri o placcato. Diffusore orientabile in rotazione e inclinazione. Cavo in pvc con interruttore. Colori: nero, nickel satinato oppure ottone satinato.





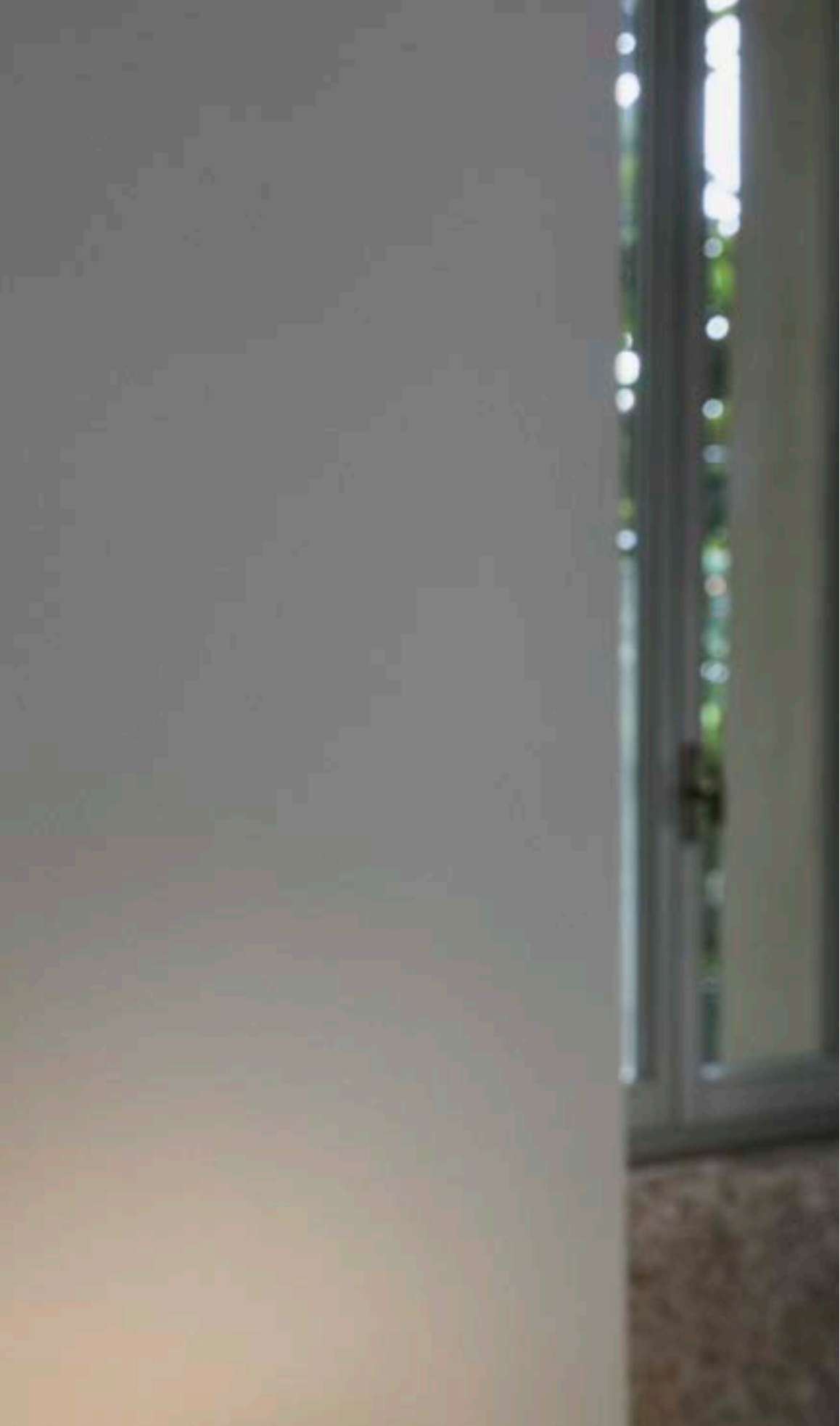











DORSALE

Montatura in metallo rifinito in cromo o con vernice opaca bianca o nera. Braccio a sezione quadrata composto da tre elementi. Paralume in lamina di PVC, disponibile in colore cromo o rivestita in tessuto bianco o nero.















EQUINOXE

Montatura a bracci in metallo con finitura cromo o ottone antico. Diffusori in vetro soffiato trasparente.















FILO

Rosone, corpo luce e base a terra in metallo verniciato a polveri o placcato. Diffusore in PC opale satinato. Cavo di sostegno in PVC nero. Alimentato dalla base a terra da cavo nero in PVC con spina. Finiture: bianco, nero oppure ottone.



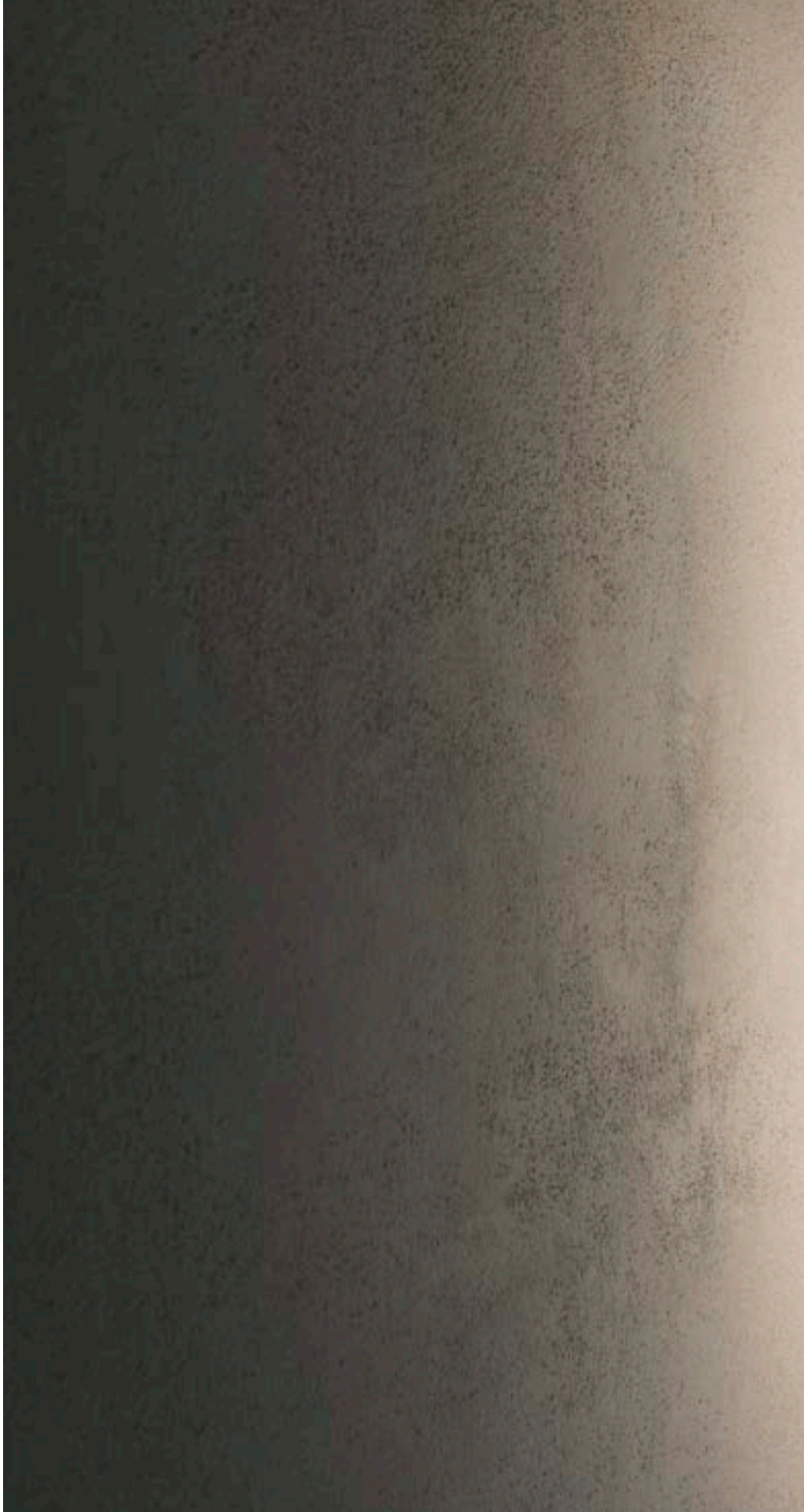









PERLAGE

Montatura in metallo. Diffusori in vetro soffiato. Finiture: nero opaco con vetri ambra o pirex fumé oppure ottone satinato con vetri bianchi acidati.













SET UP

Montature in metallo verniciato a polveri o placcato. Paralumi in pvc ignifugo rivestito di tessuto. Colori montature: bianco, nero oppure nickel satinato o ottone spazzolato. Colori paralumi: beige, tortora, bianco o nero.









YOKO

Base e montatura in metallo verniciato opaco. Diffusore in policarbonato opale. Cavo in pvc con presa-alimentatore. Colori: bianco o nero.



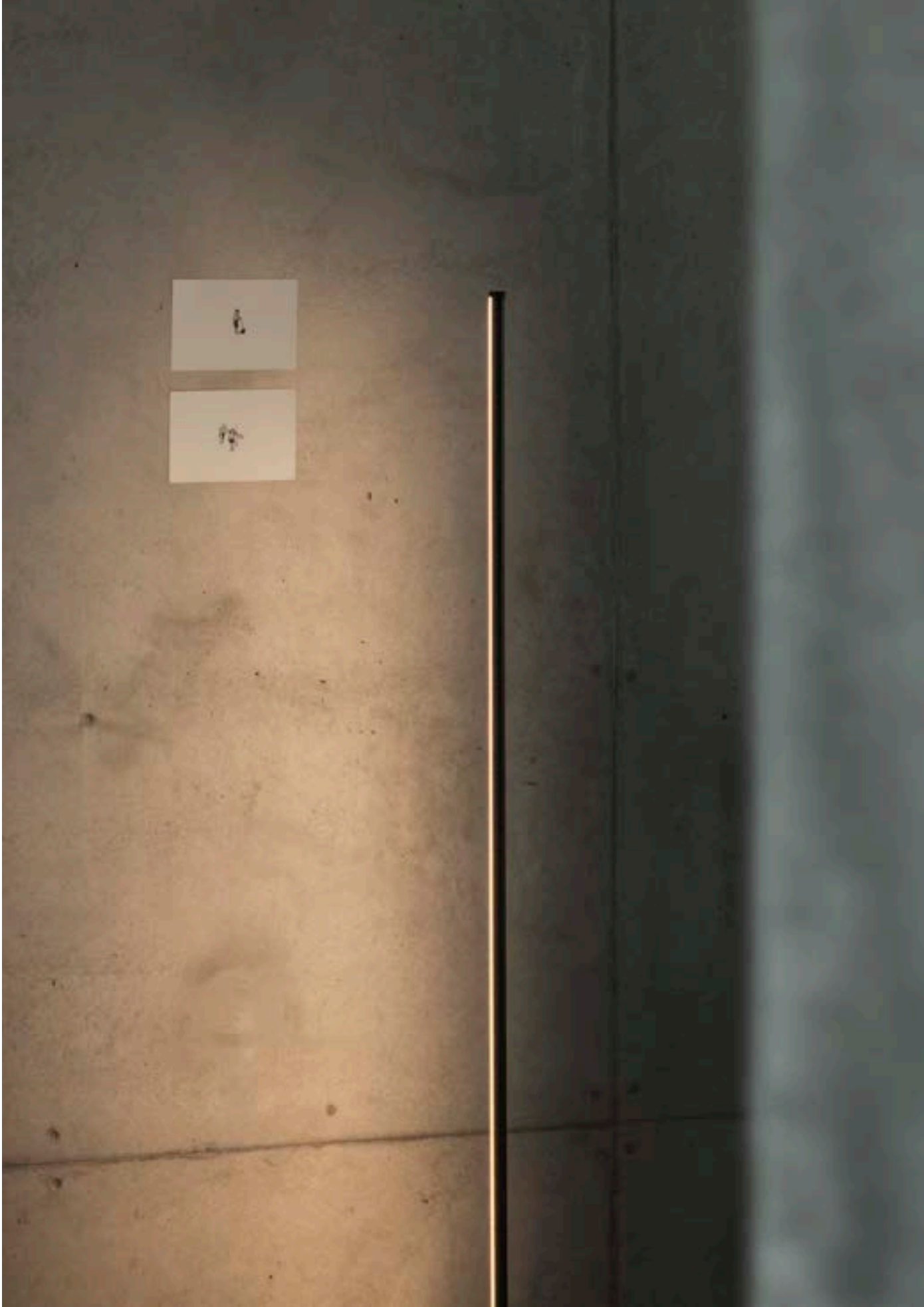



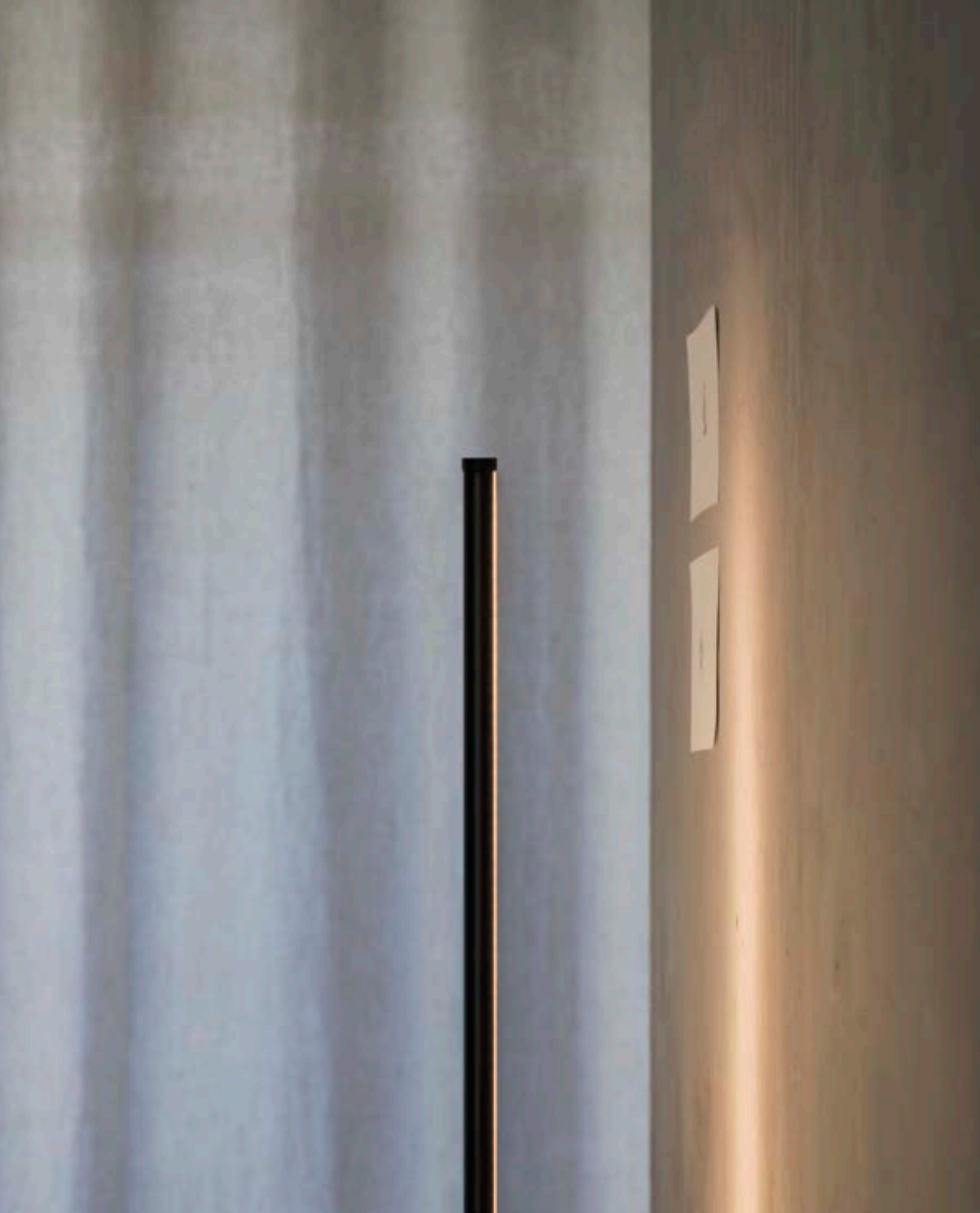



SISTEMI, PROIETTORI E BINARI

LIBRO
APERTO,
LUCE CHE
SI POSIZIONA,
PAGINE
CHE VOLANO,
PAROLE CHE
SI ESPANDONO,
CONTORNI
CHE SI
DELINEANO,
OCCHI CHE
SI POSANO,
MENTE
CHE SI APRE,
ANIMA
CHE SI LIBERA.





Indice



288 **Display**
296 **Ego**
316 **Eos**
324 **Fluo**
330 **Fox**
334 **Linus**
340 **Quick**
346 **Tesi**

SOLO SCHEDE TECNICHE

580	Link
513	Look



DISPLAY

Proiettore lineare in alluminio adatto per installazione su binario trifase (standard Eutrac), disponibile in tre differenti lunghezze e con verniciatura a polveri in finitura bianca o nera. Il driver di alimentazione integrato è alloggiato all'interno del binario per minimizzare l'ingombro del prodotto visibile.



















EGO

Sistema lineare composto da un profilo in alluminio estruso ed elementi di illuminazione a fissaggio magnetico con blocco meccanico di sicurezza. Il sistema è disponibile in colore nero opaco RAL 9005, bianco opaco RAL 9016 oppure ottone satinato anodizzato, nella modalità d'installazione a plafone o sospensione (LOW e HIGH), incasso senza bordo a scomparsa nel cartongesso (RECESSED), incasso rapido nel cartongesso (RECESSED EASY) o incasso con bordo per controsoffitti in cartongesso o a pannelli (RECESSED TRIM).

Possibilità di composizione con diversi moduli luminosi a seconda della disposizione desiderata, modificabile all'occorrenza.

Ideale per l'illuminazione di piccoli e grandi ambienti dove viene richiesta ampia flessibilità ed elevata qualità di illuminazione, ad esempio spazi museali, commerciali, residenziali e retail.





Indice
EGO



549 **Accent**
545 **Track Single**
548 **Track Flat**
550 **Wide**

SOLO SCHEDE TECNICHE

564	Drivers
551	Flexible
556	High
554	Low
553	Pendant
558	Recessed
548	Track Big
547	Track Double



EGO Track Single

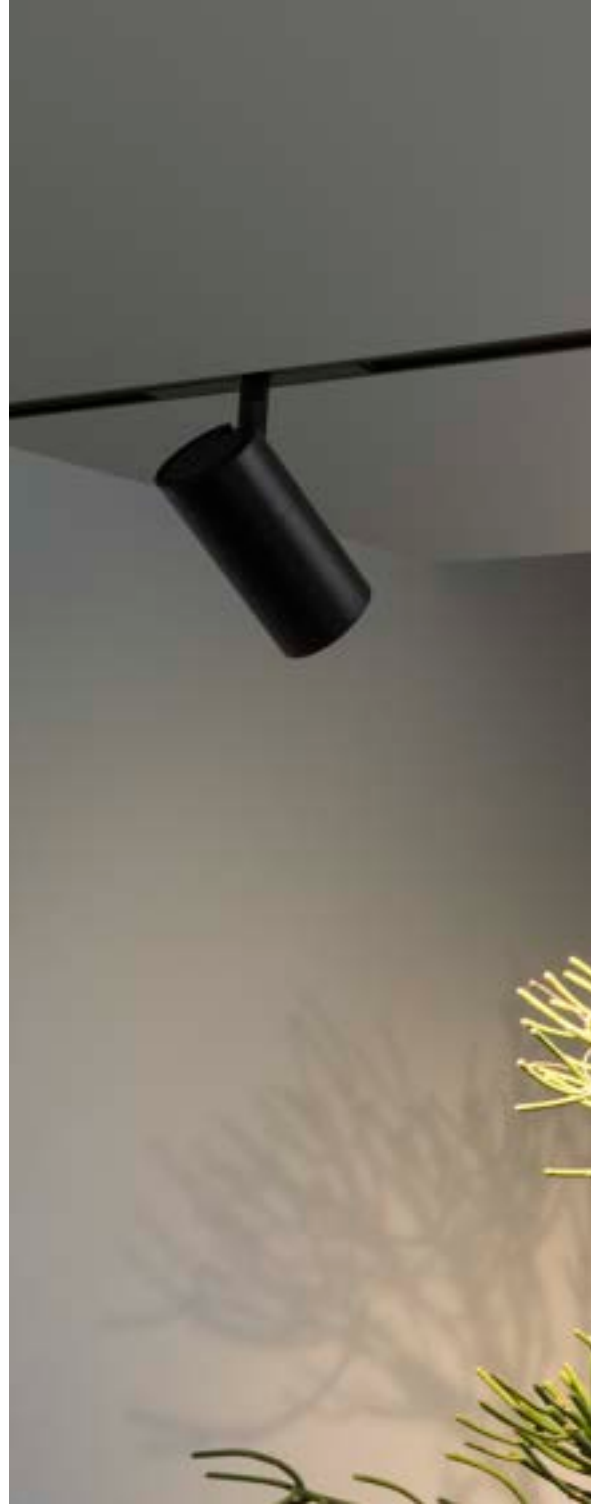









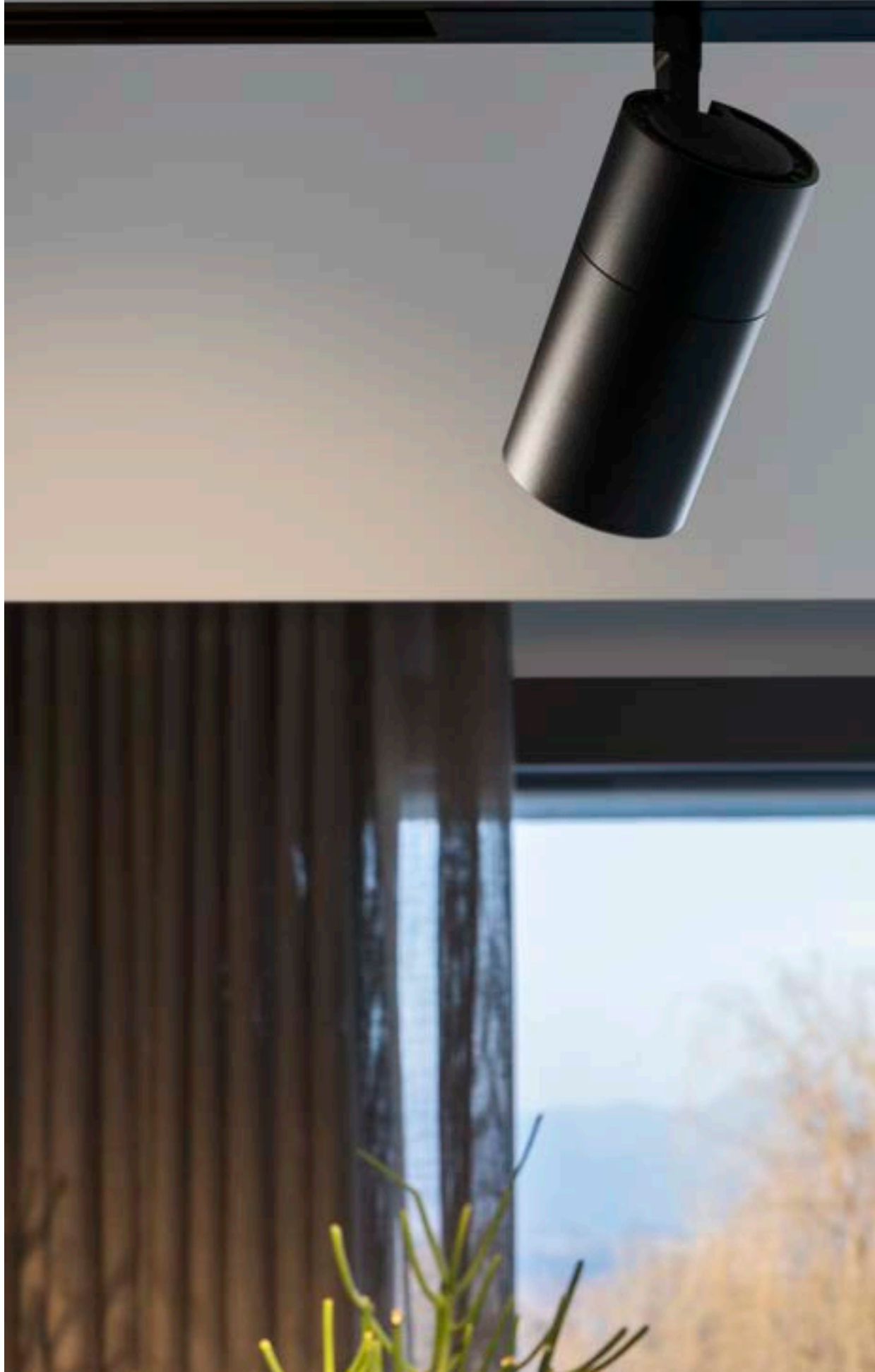

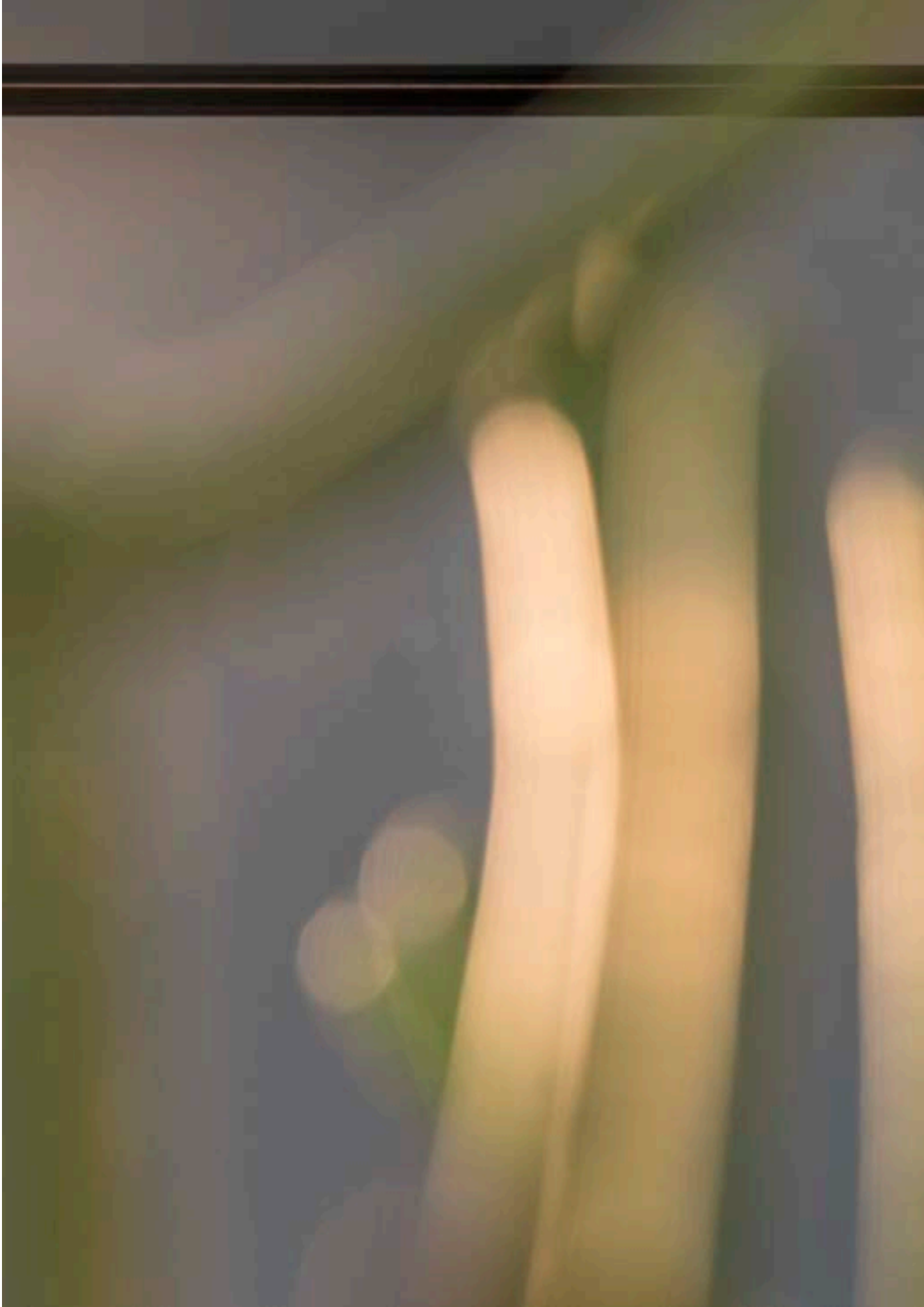





EGO Track Flat





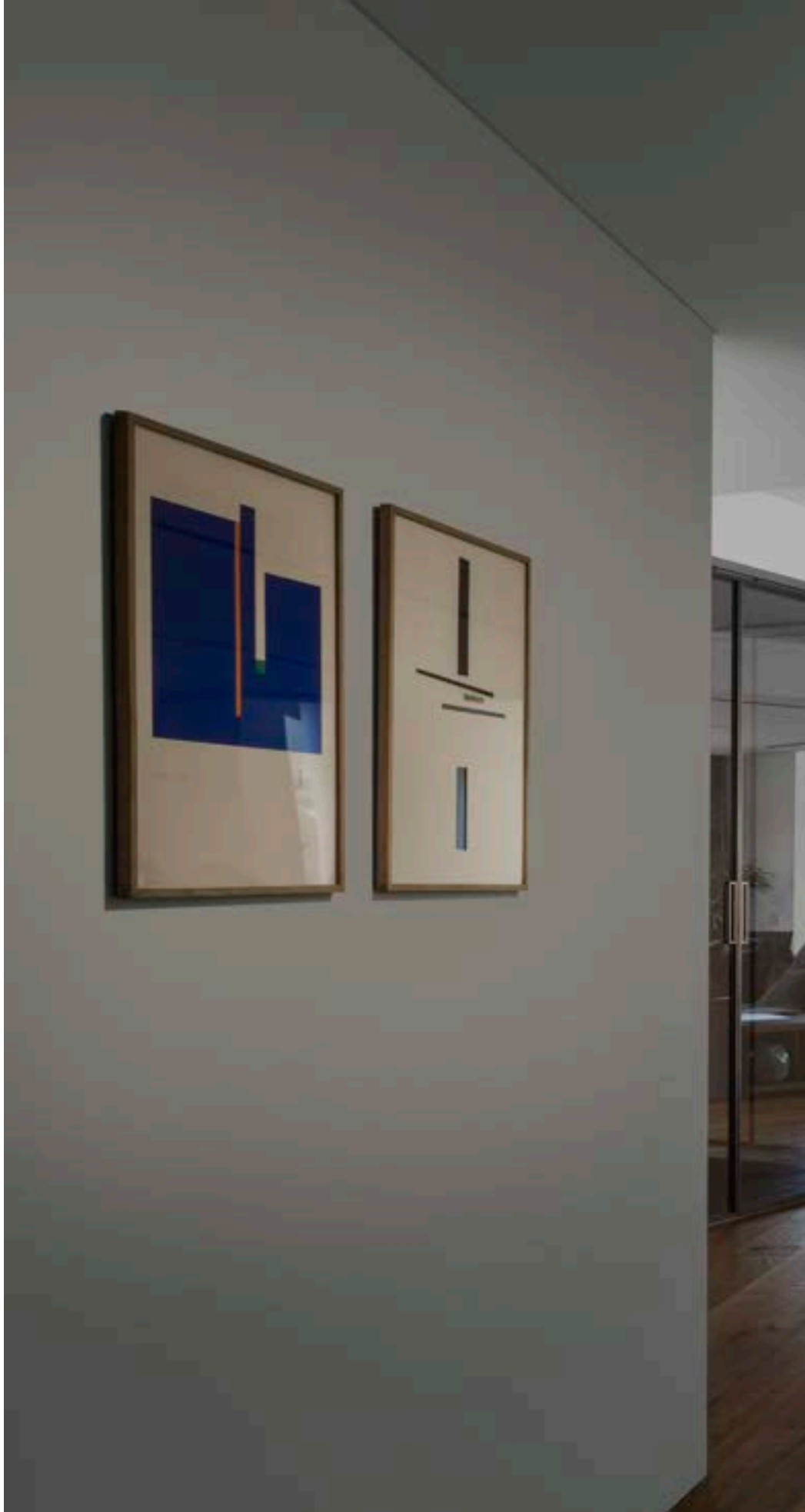





EGO Wide





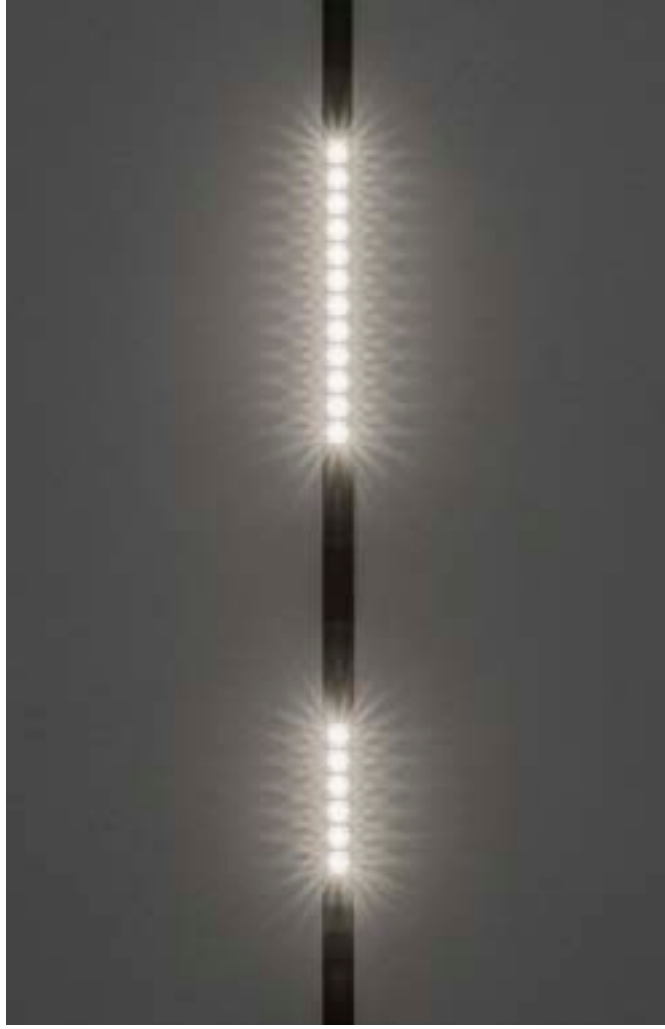







EOS

Proiettore cilindrico in alluminio estruso con ottica simmetrica e fascio di apertura variabile da stretto ad ampio (20°-55°), adatto per installazione su binario trifase. Verniciatura a polveri in bianco o nero, testata girevole 355° e orientabile fino a 90°; il driver di alimentazione è incluso e trova alloggiamento nel corpo cilindrico del proiettore stesso. Ideale per l'illuminazione di grandi ambienti dove viene richiesta ampia flessibilità e alta resa cromatica, ad esempio aree espositive, spazi museali e retail.











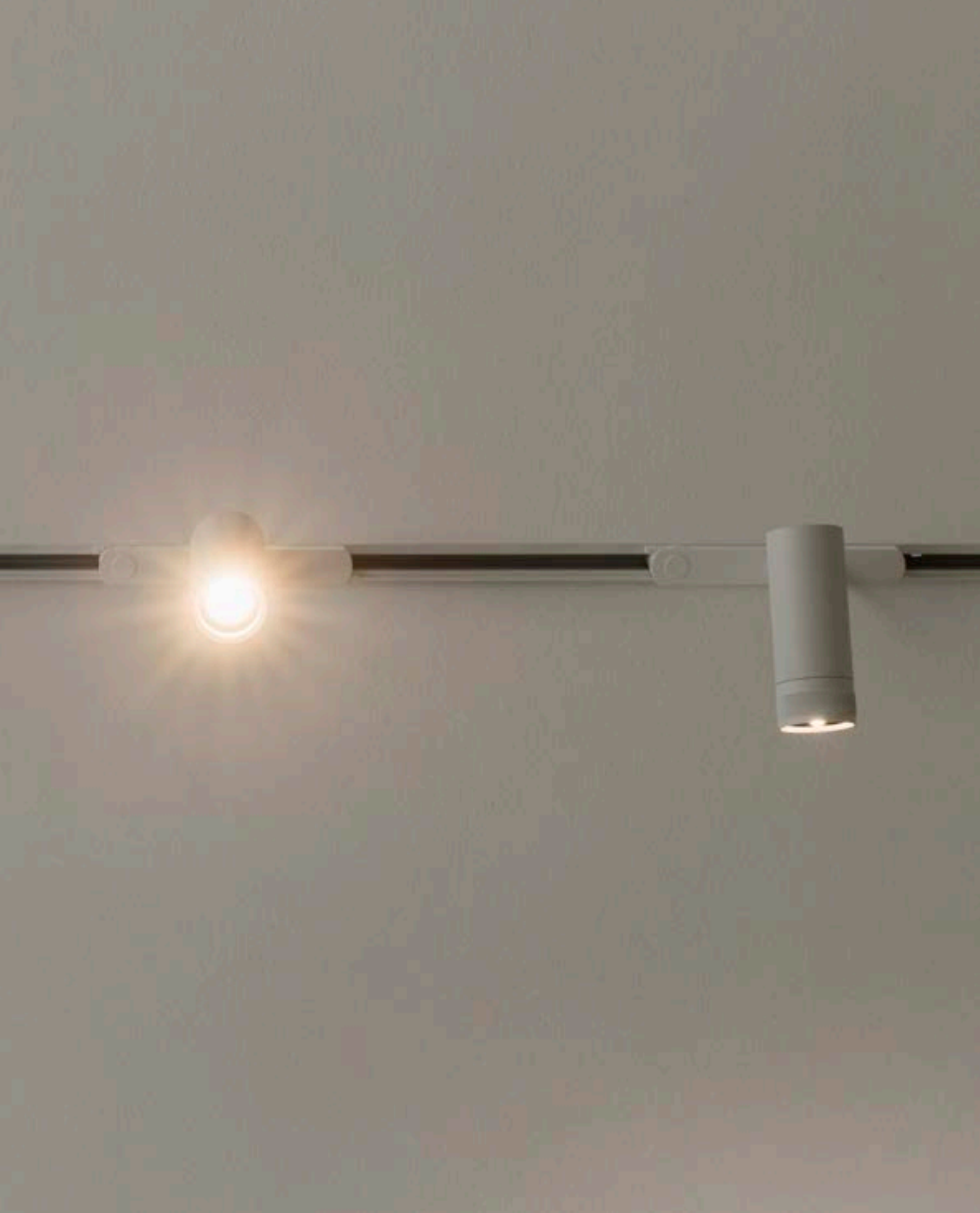







FLUO

Sistema lineare di lampade con scocca in alluminio estruso di sezione larga 50 mm e alta 80 mm. Moduli disponibili in due lunghezze: 1200 mm e 1800 mm, componibili tra loro a seconda della disposizione desiderata. Il sistema è disponibile con tre diversi configurazioni: il modello WIDE diffondente, il modello BI-EMISSION con componente luminosa per l'illuminazione indiretta e il modello ACCENT con controllo dell'abbagliamento.













FOX

Proiettore cilindrico in alluminio estruso, adatto per installazione su binario trifase. Verniciatura a polveri in bianco, nero oppure ottone satinato, testata girevole 350° e orientabile fino a 90°; il driver di alimentazione è incluso e trova alloggiamento nel corpo cilindrico del proiettore stesso. Ideale per l'illuminazione di piccoli e medi ambienti dove vengono richiesti ampia flessibilità di disposizione, ad esempio in spazi commerciali e retail, e un rapporto ottimale tra prestazioni e prezzo.









LINUS

Lampada lineare in alluminio con illuminazione diretta e indiretta per applicazione a parete. La lampada è modulare e può essere proposta singolarmente oppure in linea continua. È disponibile in finitura bianca o nera.















QUICK

Proiettore cilindrico in alluminio estruso adatto per installazione su binario trifase. Verniciatura a polveri bianco o nero, testata girevole 355° e orientabile 90°. Il driver di alimentazione incluso, trova alloggiamento nel corpo cilindrico del proiettore stesso. Ideale per l'illuminazione di grandi ambienti dove viene richiesta ampia flessibilità e resa cromatica, ad esempio spazi museali, commerciali e retail.







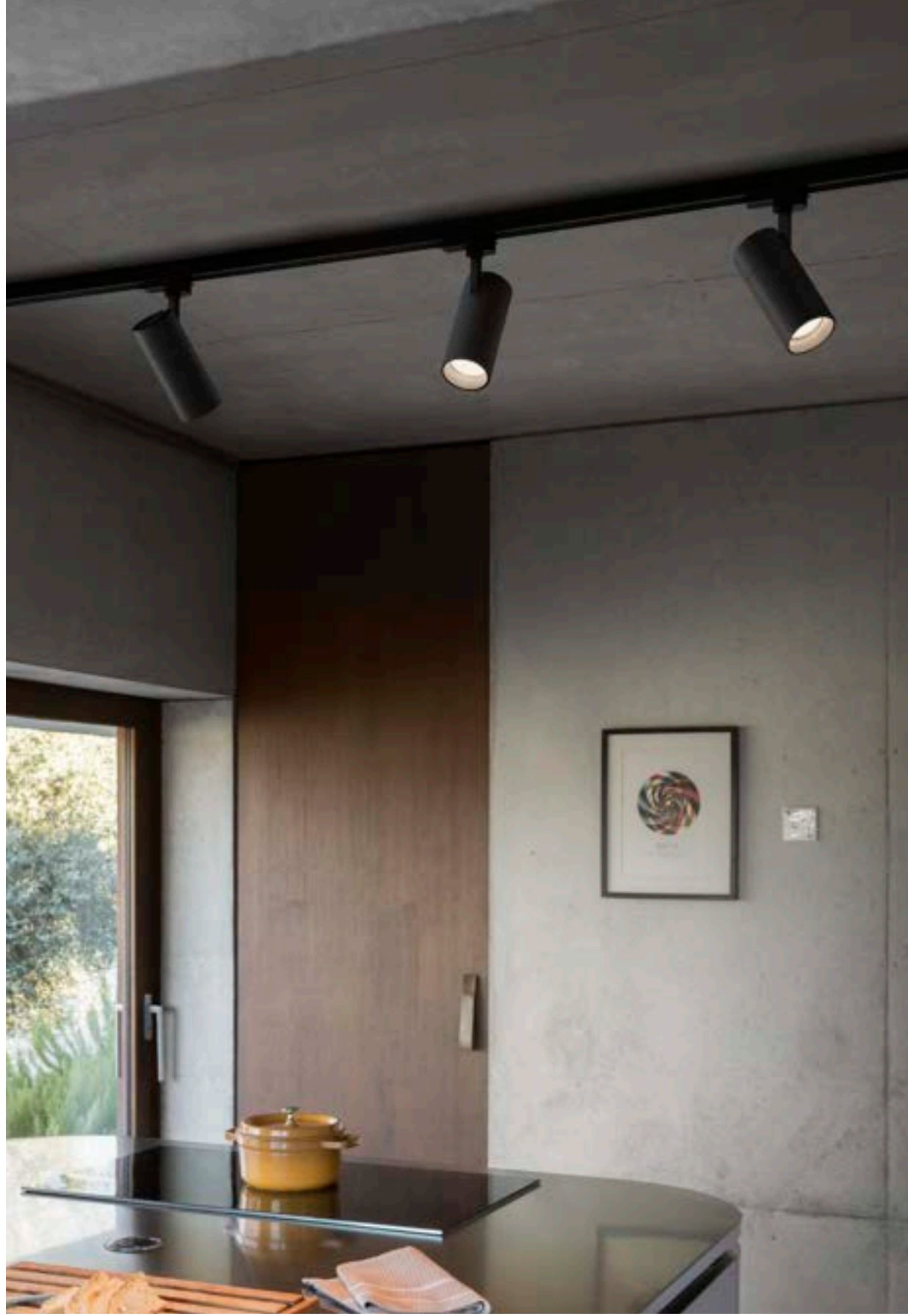





TESI

Nastro flessibile in acciaio per applicazione da parete a parete, utilizzato come supporto per applicazione di strip led, diventa una sorgente luminosa per illuminazione indiretta. Ha una lunghezza massima di 5 o 10 metri e con la sua sezione minimale scompare all'interno dell'ambiente per garantire un risultato di estrema pulizia formale. Disponibile nelle finiture acciaio, bianco oppure nero. Ideale per ambienti dal carattere storico e architettonico già fortemente personalizzati.







TESI

SISTEMI, PROIETTORI E BINARI

INTERNI

IDEAL LUX





LAMPADE DA INCASSO

TENDE TIRATE,
LAMPADE
CHE SI SPENGONO,
MATTINO
CHE VIBRA,
GIARDINO
CHE DÀ PACE.
SVEGLIARSI
IN ARMONIA,
BRINA CHE
SI DISSOLVE,
QUIETE
CHE ABBRACCIA,
NELL'ALBA
CHE SI POSA.





Indice

↳

352 **Bento**
358 **Game**
364 **Lika**
368 **Nova**
374 **Virus**



BENTO

Sistema componibile di elementi ad incasso costituito da sorgente orientabili, riflettore e ghiera, con lenti e accessori schermanti in opzione; finitura bianca e nera; ghiera a incasso disponibile in forma singola rotonda o quadrata, oppure rettangolare in versione doppia o tripla per l'installazione di sorgenti multiple e indipendenti; anello anti-abbagliamento opzionale per arretramento della sorgente in modalità non orientabile; tre diversi angoli di emissione a scelta.









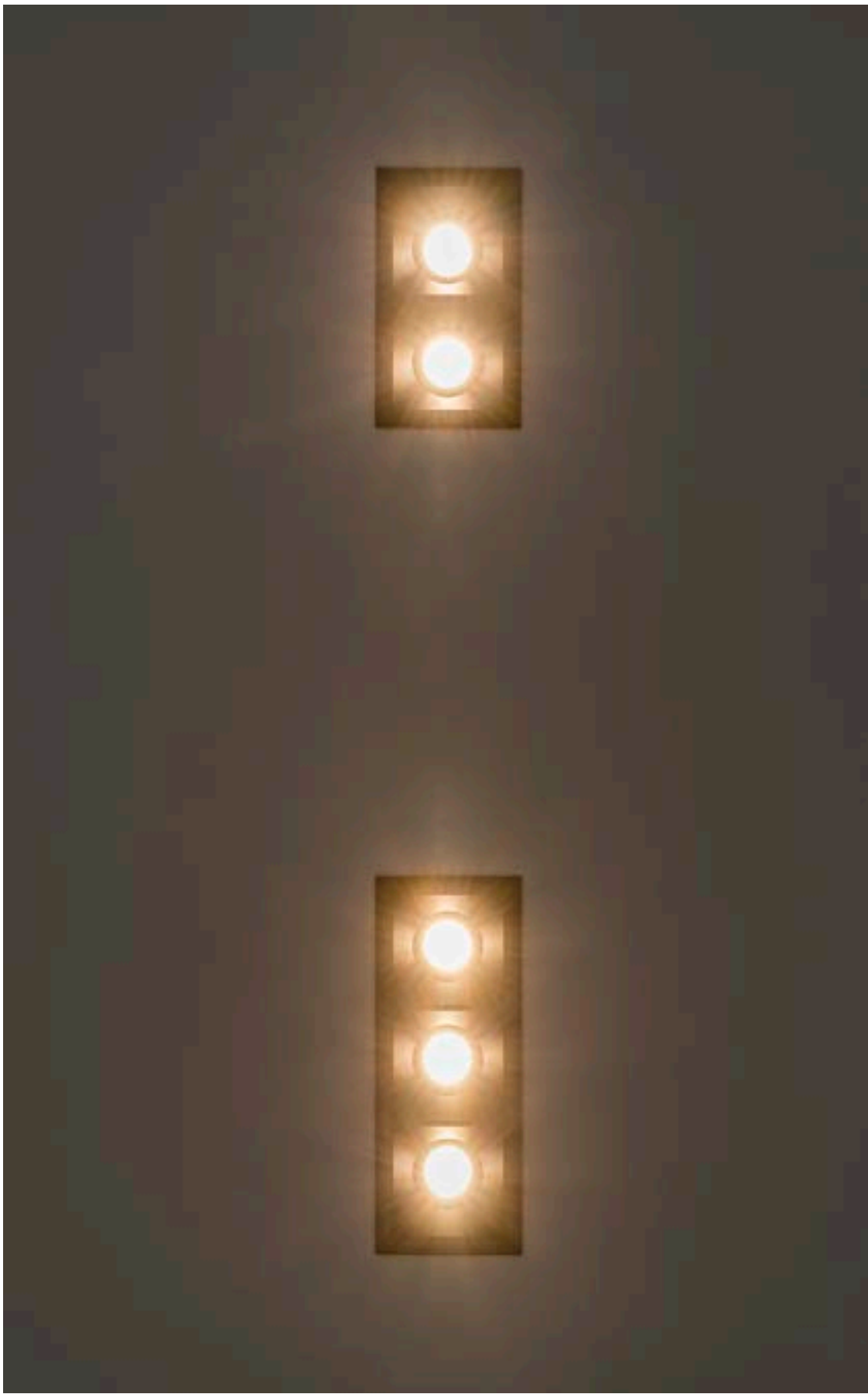



GAME

Faretto ad incasso in alluminio pressofuso con ghiera rotonda o quadrata, adatto per installazione su soffitti in cartongesso o a pannelli. Finitura cromata, bianca opaca RAL 9001, nera opaca RAL 9011, oro opaca RAL 1032. Disponibile in versione con cornice esterna (TRIM), a scomparsa senza cornice per cartongesso (TRIMLESS), oppure con cornice e protezione frontale migliorata (IP65).









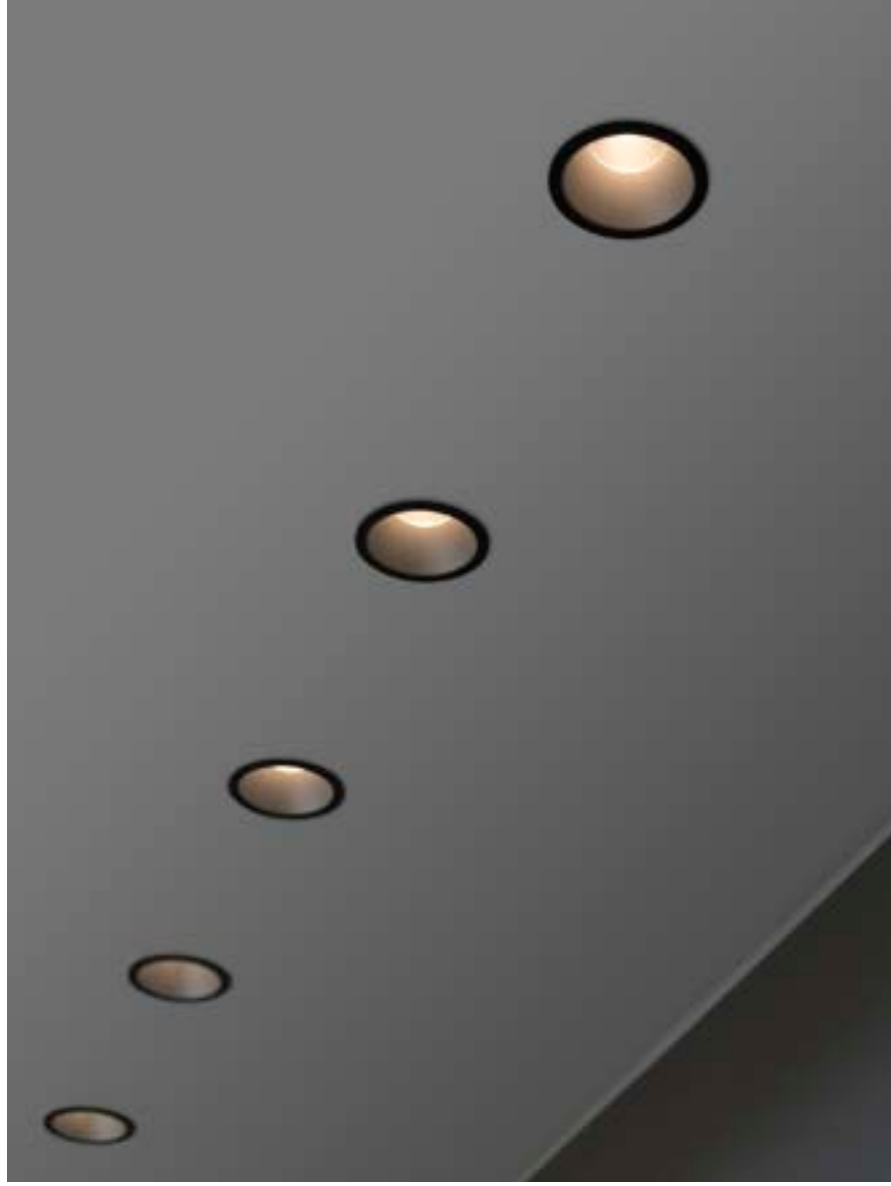





LIKA

Proiettore a incasso LED rettangolare in alluminio pressofuso verniciato nero o bianco, con riflettore in policarbonato nero lucido. Disponibile nelle versioni TRIM e SLIM con cornice per installazione su pannelli o soffitti, oppure TRIMLESS con bordo arretrato a scomparsa per installazione su soffitti in cartongesso.









NOVA

Faretto a incasso in alluminio pressofuso con ghiera rotonda, adatto per installazione su soffitti in cartongesso o a pannelli. Finitura bianca opaca o nera opaca. Sorgente orientabile a 360° ed estraibile fino a 90° rispetto all'asse verticale. L'elevata resa cromatica e la massima flessibilità di orientamento lo rendono ideale per gli spazi espositivi e la valorizzazione della merce in showroom e aree vendita nel settore retail.







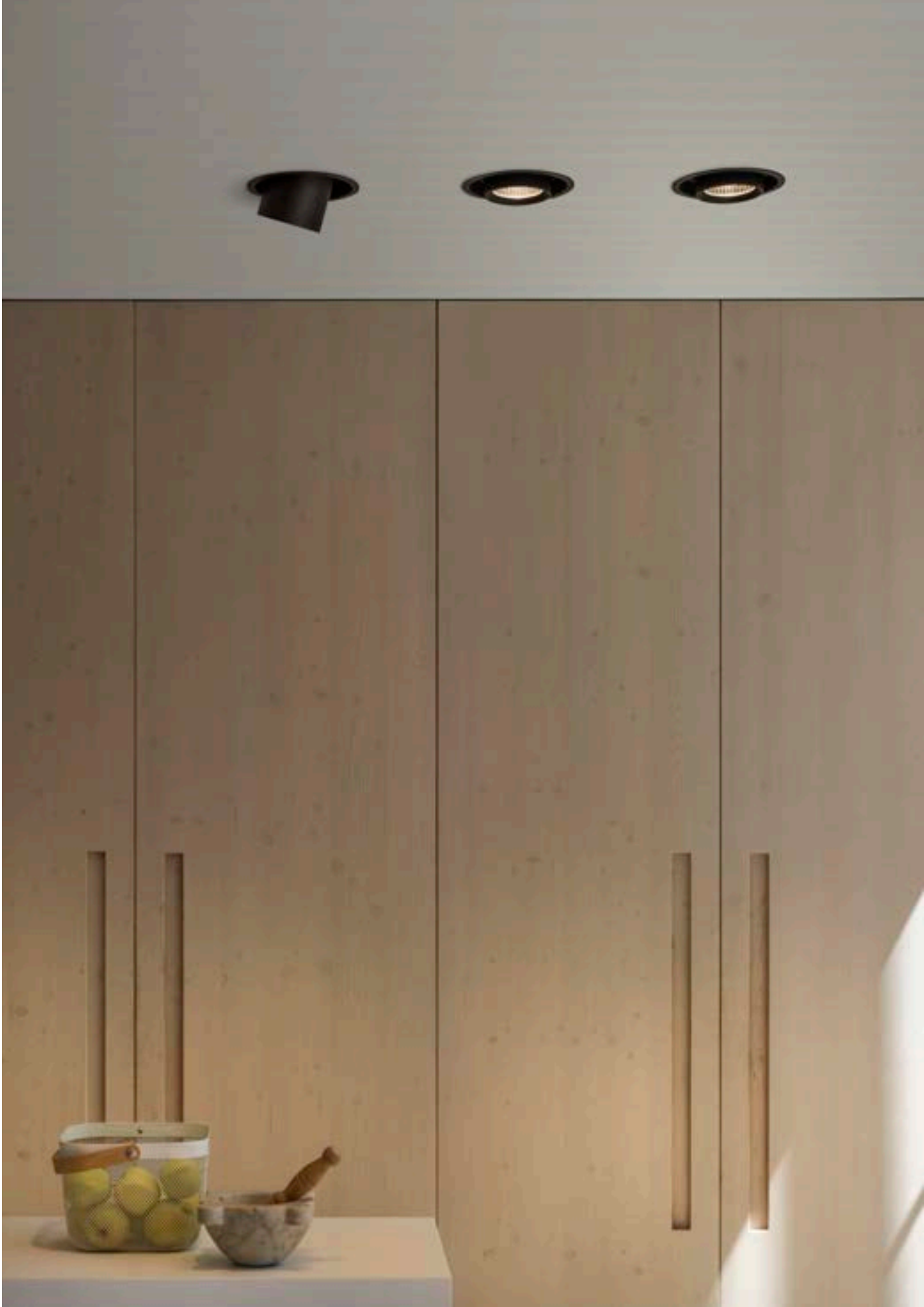





VIRUS

Mini-faretto a incasso in alluminio con ghiera rotonda, adatto per installazione su soffitti in cartongesso o a pannelli. Finitura bianca opaca, nera opaca, oro opaco. Tecnologia LED SMD; disponibile in temperatura di colore 3000 K; CRI \geq 90; protezione IP20; classe isolamento II; durata utile LED 30.000 h L70B50. L'elevata resa cromatica e le dimensioni ridotte lo rendono ideale per l'illuminazione di accento in nicchie e vetrine negli ambienti interni domestici e retail.









LAMPADE DA ESTERNO

PROFUMO
DI FIORI
CHE SI SPECCHIANO
IN PISCINA,
IL SOLE
CHE SI RITIRA,
IL GIARDINO
CHE S'ILLUMINA.
LUCI DANZANTI,
PREPARANO
LA SCENA
DELLA SERA.
BICCHIERI
CHE TINTINNO,
PREPARANDOSI
PER LA CENA.

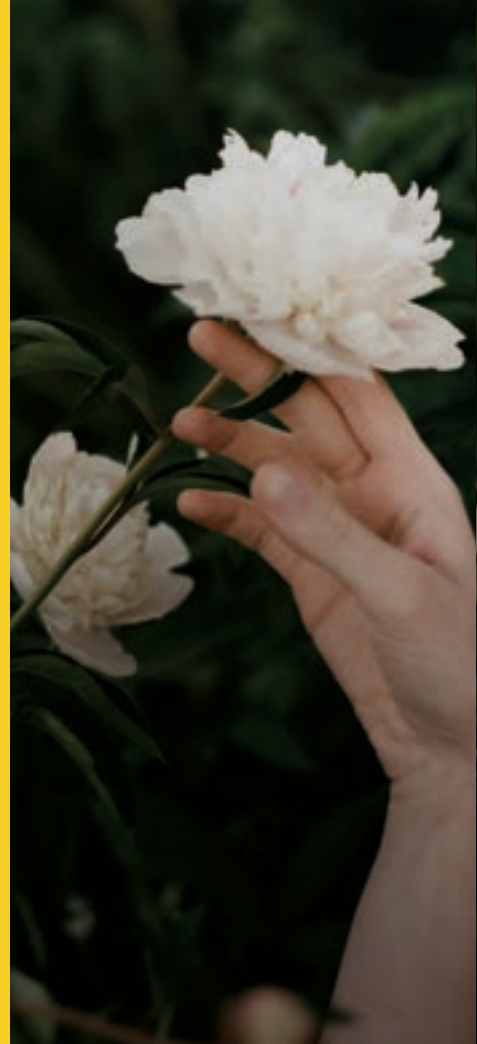



Indice

↳

380	Agos
388	Andromeda
392	Djambe
400	Gun
408	Ipotesi
414	Jedi
420	Lolita
428	Sirio
436	Sole
442	Starlight
448	Style
454	Taurus
460	Techo
466	Tesla
472	Vega



AGOS

Corpo luce in alluminio pressofuso verniciato a polveri. Diffusore in acrilico trasparente satinato. Colore antracite, coffee e nero.





LAMPADE DA TERRA ESTERNI IDEAL LUX















ANDROMEDA

Corpo luce in alluminio pressofuso verniciato. Doppio diffusore, superiore e inferiore, in vetro pirex satinato. Disponibile nelle finiture antracite, bianco, coffee, grigio o nero.









DJAMBE

Corpo luce in metallo verniciato a polveri. Diffusore in materiale plastico opale ruvido. Emissione luce in basso. Cavo in neoprene nero con spina. Finiture: coffee oppure nero.



















GUN

Corpo luce in alluminio con finitura naturale spazzolata o in vernice con varie finiture. Diffusore in vetro pirex trasparente. Emissione luce sopra e sotto.













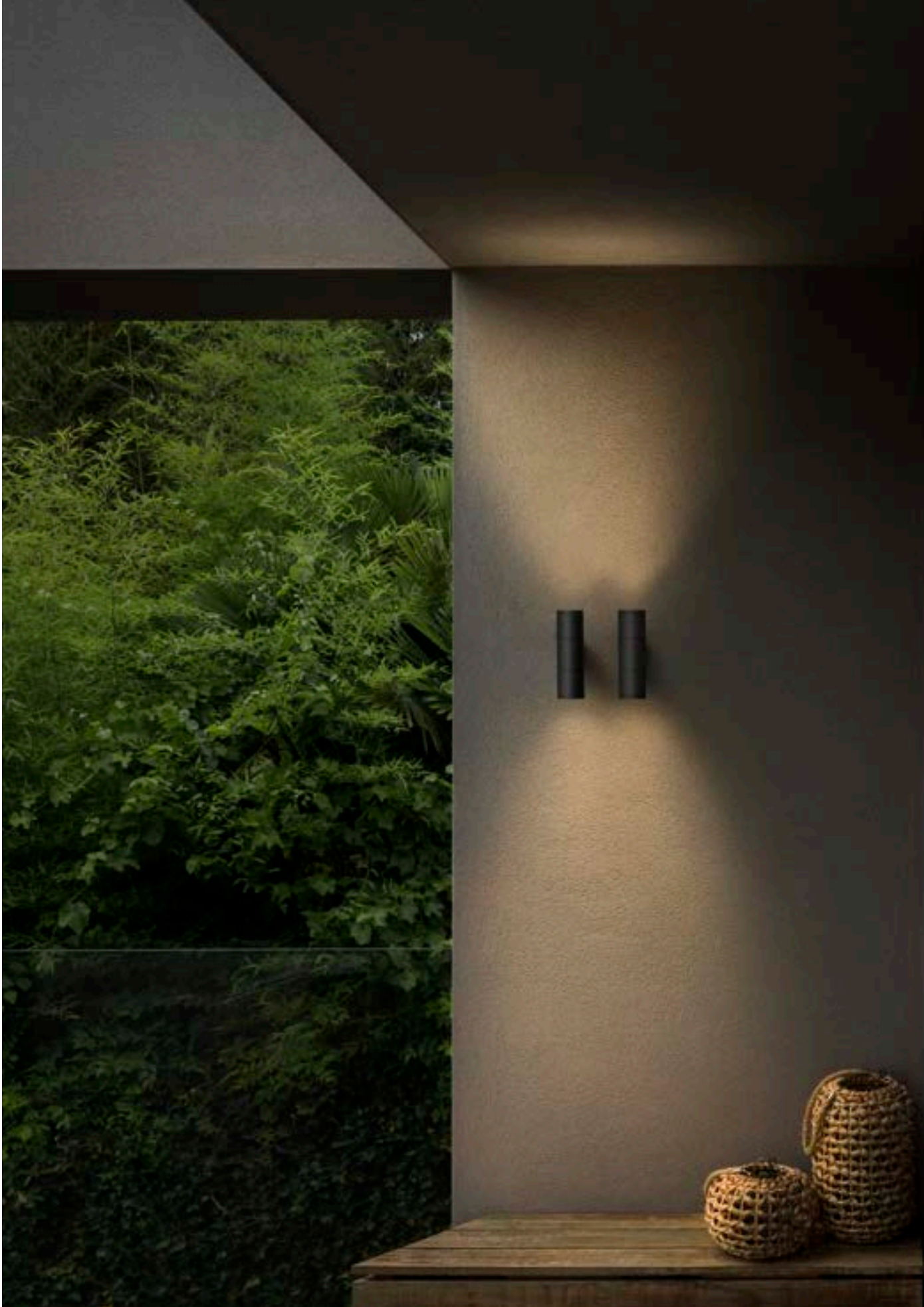





IPOTESI

Montatura interamente in alluminio verniciato a polveri. Diffusore in policarbonato opale. Cavo nero in gomma con interruttore, driver esterno incorporato e spina. Colore: bianco o nero.















JEDI

Base e corpo luce in alluminio verniciato a polveri. Diffusore in policarbonato opale lucido. Fornito con picchetto per installazione su terreno. Finiture: antracite oppure nero.





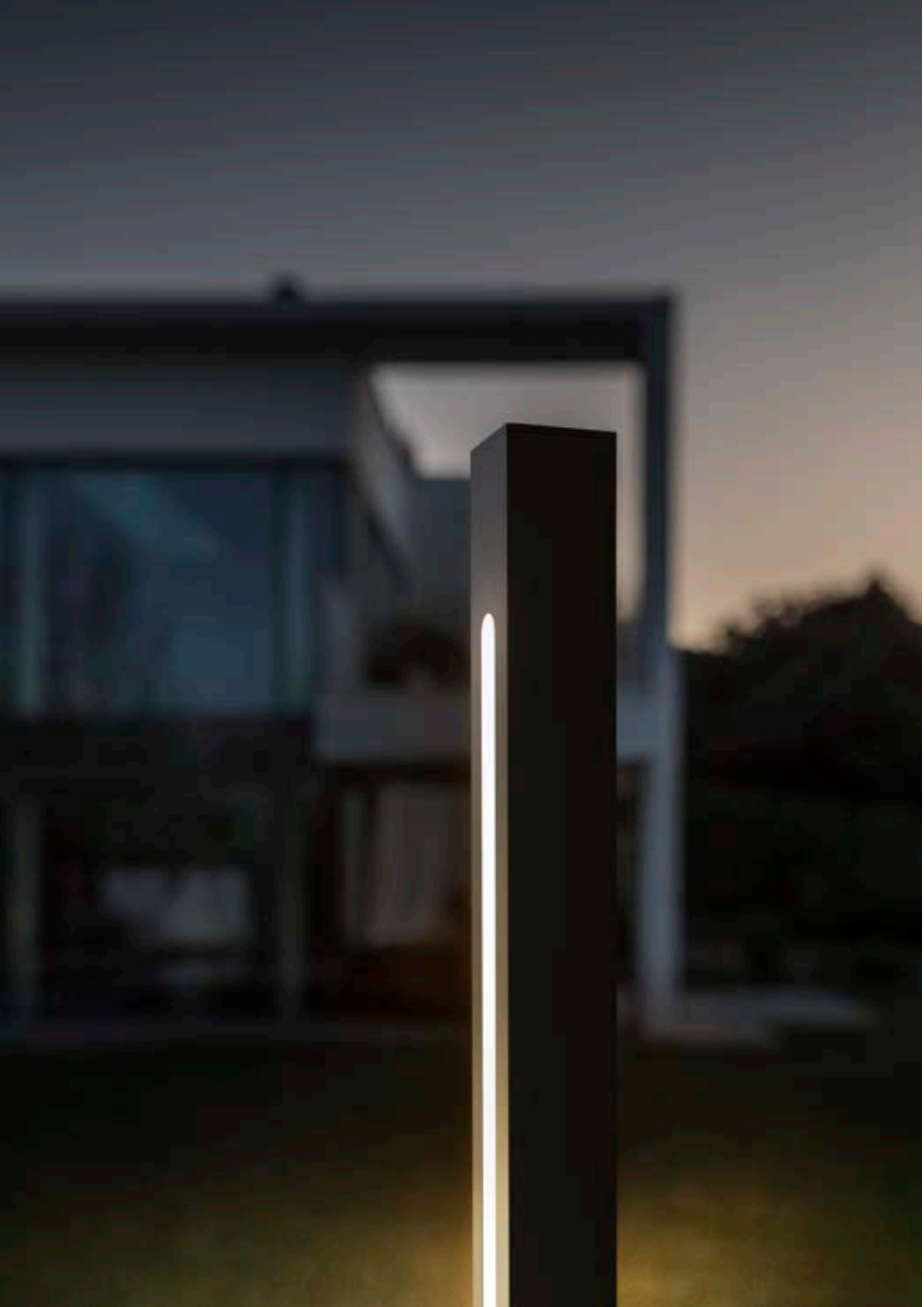

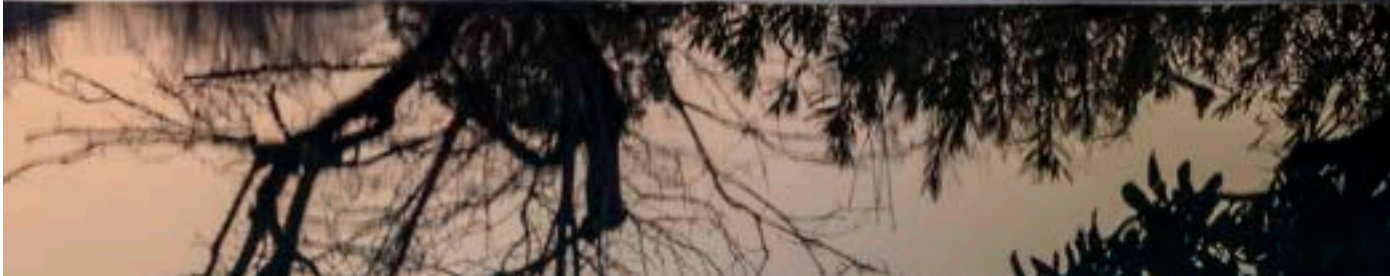





LOLITA

Lampada da tavolo a batteria ricaricabile con finitura bianca, grigia, nera o coffee. Base in plastica. Montatura in metallo. Diffusore in materiale plastico. Autonomia di 14 ore. Tempo di ricarica della batteria 7 ore.





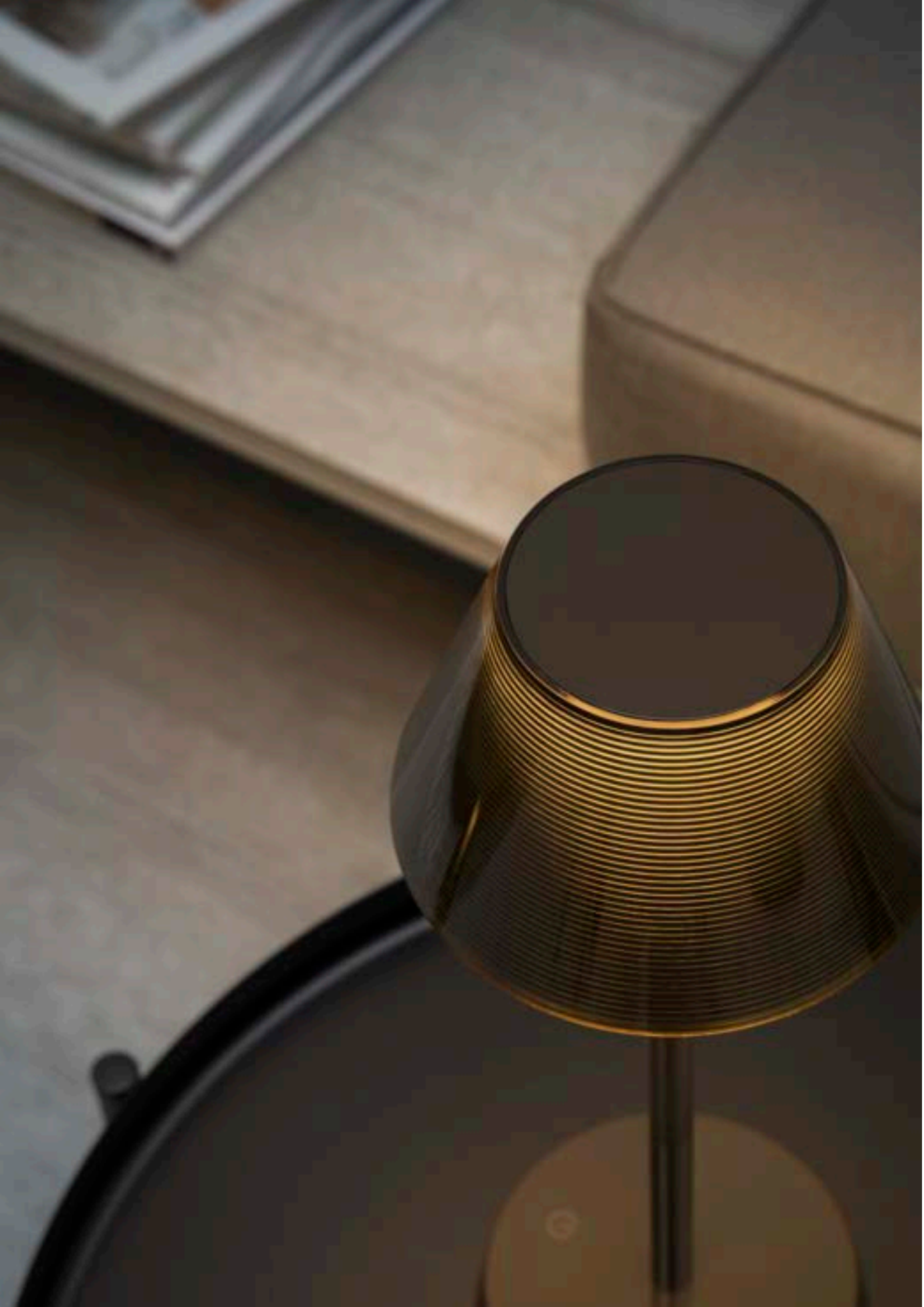

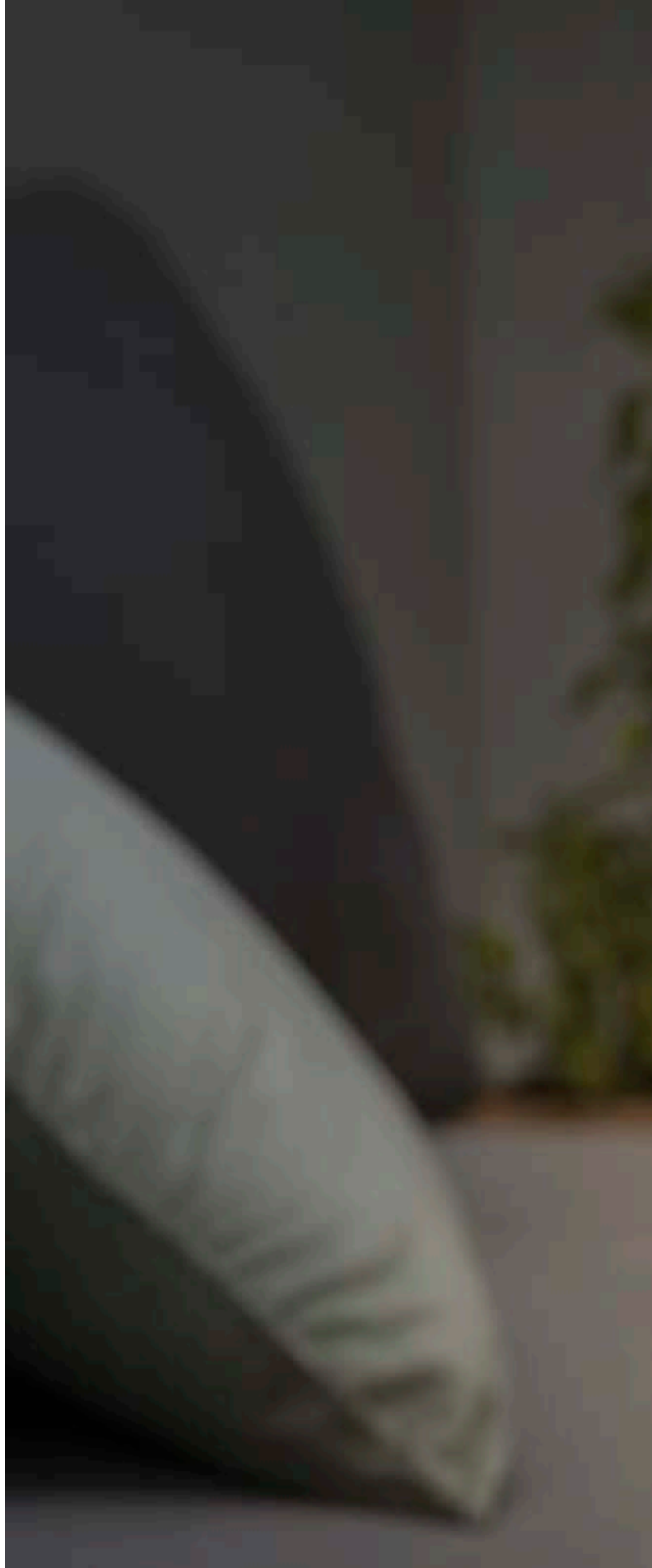

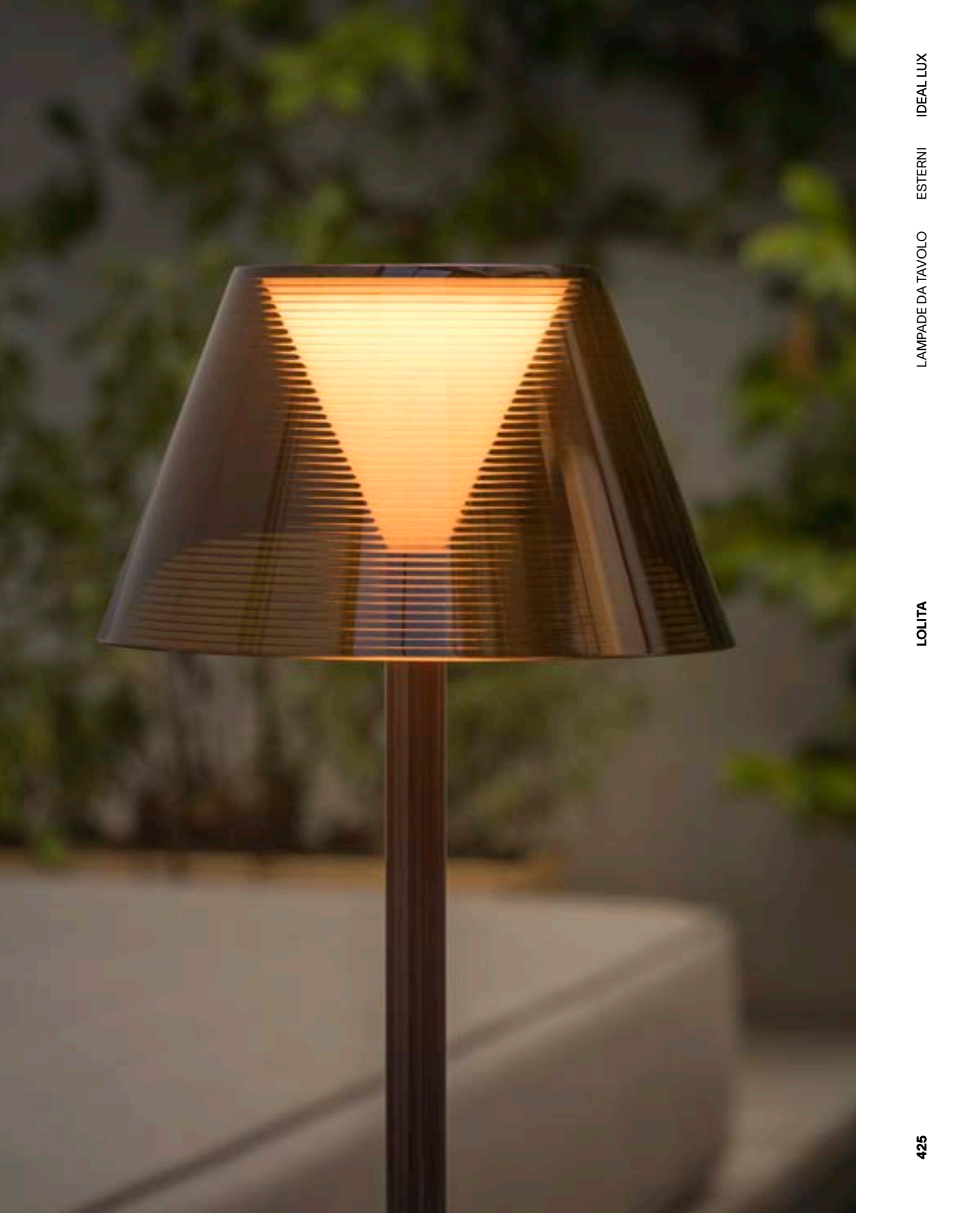

ST







SIRIO

Corpo luce in alluminio verniciato a polveri. Diffusore in vetro pirex trasparente. Disponibile nelle finiture antracite, bianco, coffee, grigio o nero.









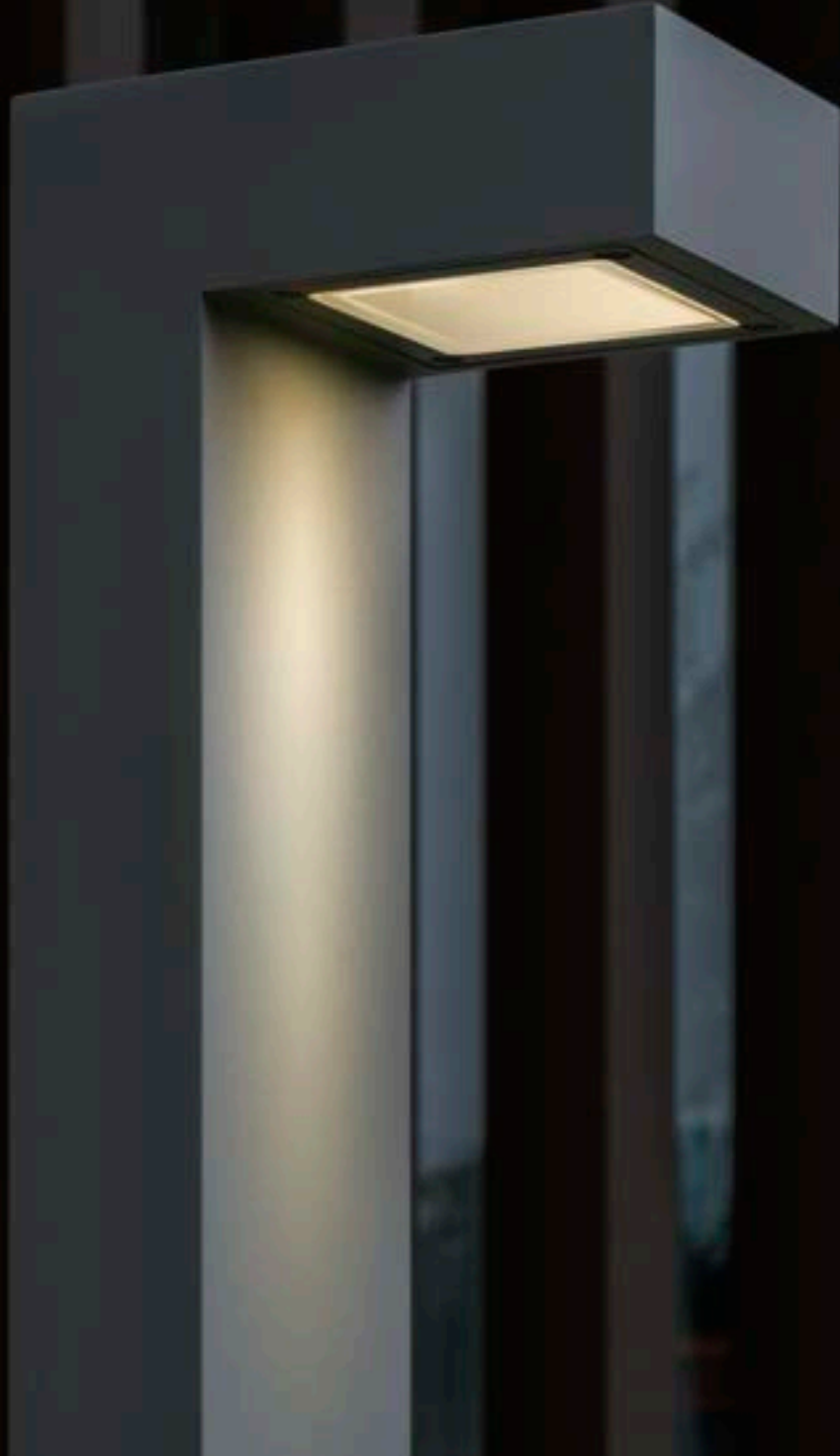









SOLE

Diffusore in materiale plastico opale. Fornito con spina e picchetto per terreno.







LAMPADE DA TERRA

ESTERNI

IDEAL LUX







STARLIGHT

Proiettore orientabile in alluminio con fissaggio a plafone o con picchetto; superficie anodizzata e verniciata a polveri in grigio scuro; LED integrato ad efficienza energetica con elevata resa cromatica; disponibile in temperatura di colore 3000K e 4000K; durata utile LED 50.000 h. Visiera antiabbagliamento in opzione.



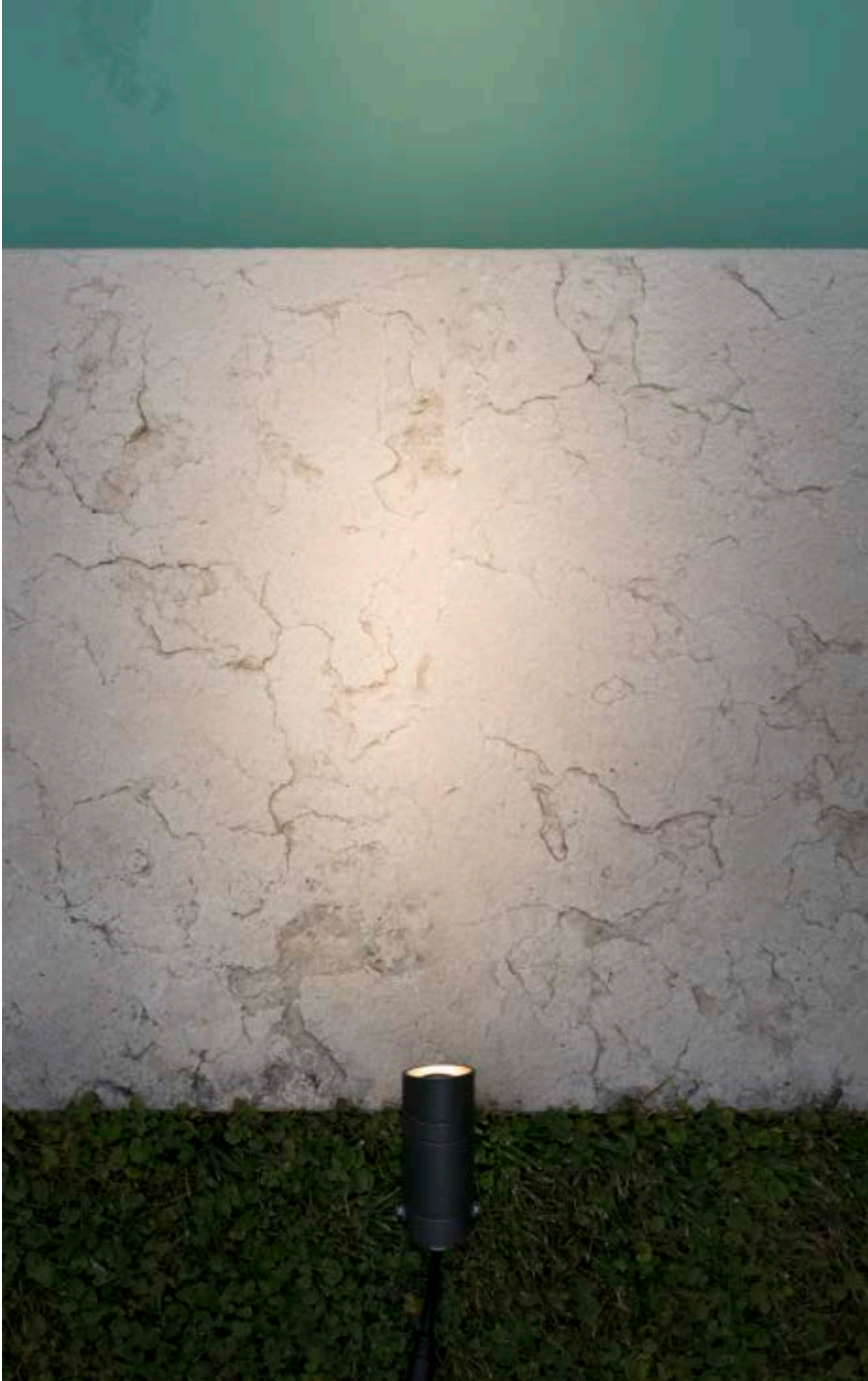









STYLE

Corpo luce in alluminio verniciato a polveri. Diffusore in materiale plastico opale. Sorgente luminosa a led integrato. Disponibile nelle finiture antracite, bianco, coffee, grigio o nero.















TAURUS

Proiettore da incasso calpestabile per installazione a pavimento, parete o soffitto. Corpo in alluminio pressofuso, ghiera rotonda o quadrata in acciaio inox 316L, diffusore in vetro. Sorgente luminosa a LED integrato; disponibile nelle versioni ACCENT con 1, 2 o 3 moduli singolarmente orientabili di +/-30° mediante perno esterno per ampliare, restringere o direzionare il fascio luminoso complessivo; oppure nelle versioni WIDE non orientabili per un'illuminazione diffusa e uniforme.













TECHO

Corpo luce in alluminio pressofuso verniciato a polveri. Diffusore in vetro temperato trasparente smerigliato. Disponibile nelle finiture antracite, bianco, grigio, coffee o nero.















TESLA

Corpo luce in alluminio verniciato a polveri. Diffusore con schermo in materiale plastico bianco. Emissione luce verso il basso. Disponibile nelle finiture antracite, bianco, coffee, grigio o nero.















VEGA

Corpo luce in alluminio con finitura in vernice opaca a polveri. Diffusore in vetro temperato trasparente. Disponibile nelle finiture antracite, bianco, coffee, grigio o nero.













ELENCO FINITURE



TRASPARENTE



BIANCO



CROMO SFUMATO



ACCIAIO



ARGENTO



CROMO



ALLUMINIO



GRIGIO



NICKEL



FUMÈ

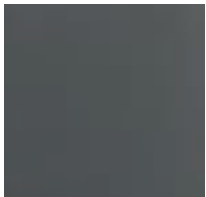

ANTRACITE

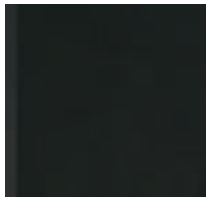

NERO



AMBRA



BEIGE



TORTORA



ORO

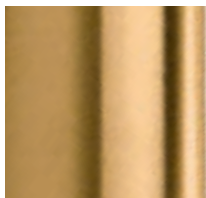

OTTONE

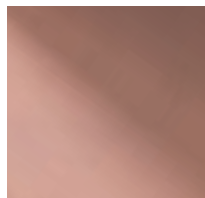

RAME



COFFEE



BRUNITO

NOTE: Le finiture rappresentate hanno scopo illustrativo. Le tonalità sono soggette a variazioni dettate dal tipo di materiale impiegato e dalla sua lavorazione che possono alterarne la resa,

di conseguenza articoli catalogati con medesima finitura potranno presentare delle differenze nella percezione del colore.

SCHEDE TECNICHE

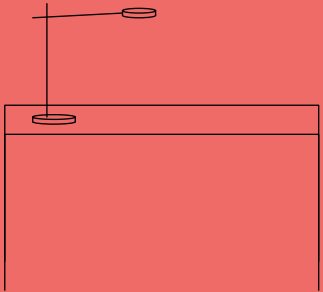
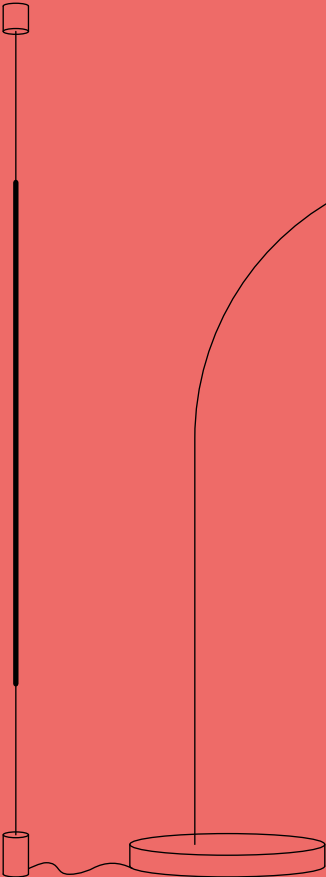
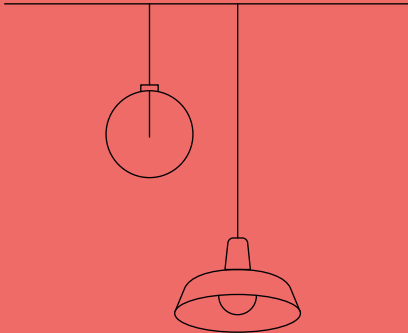
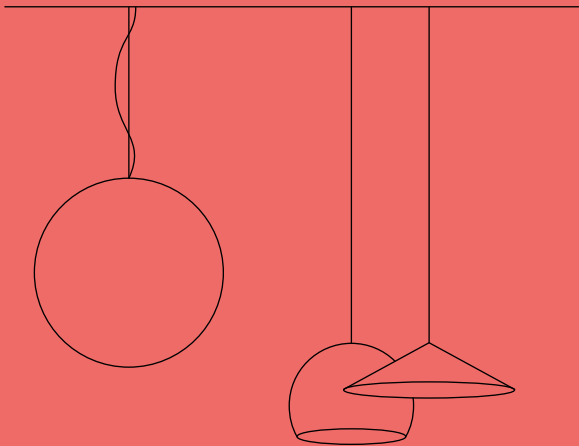

SCHEDE TECNICHE INTERNI

Lampade decorative:
indice alfabetico per icone

↳

BEAN



488

EQUINOXE



495

BIRDS

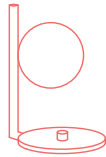

488

ESSENCE



498

CLIP

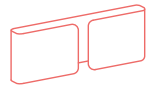

490

FADE



499

COVER



491

FILO



499

DELTA



492

FLY



502

DIESIS



492

FOCUS



506

DORSALE

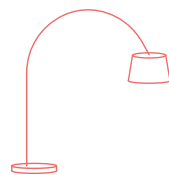

493

FRAME

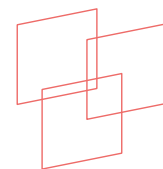

506

DOT



494

FUTURA

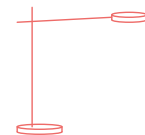

508

DYNAMITE



494

GEMINI

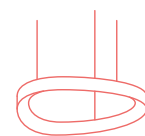

509

LOOK



511

PERLAGE



525

MAPA BIANCO

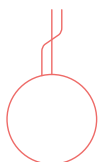

513

PIANO



531

MINT



517

PIVOT

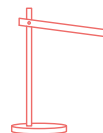

532

MIX UP

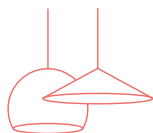

518

SET UP



532

MOBY

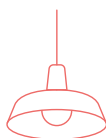

519

SPIKE



536

NEMO



520

ULTRATHIN



536

ONION

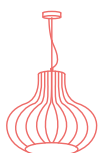

521

YOKO

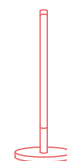

537

ORACLE SLIM

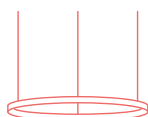

522

ZIG ZAG



538

OZ



524

Lampade tecniche:
indice alfabetico per icone

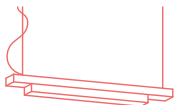

BENTO  540

DISPLAY  542

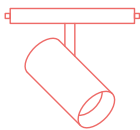
EGO  545

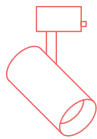
EOS  565

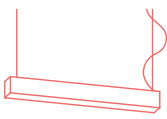
FLUO  566

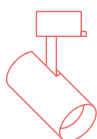
FOX  571

GAME  574

LIKA  577

LINK  580

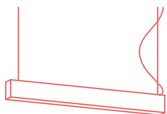
LINUS  588

NOVA  589

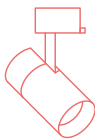
QUICK  590

TESI  593

VIRUS  594

SCHEDE TECNICHE ESTERNI

Lampade per esterni:
indice alfabetico per icone

↳

AGOS



595

STARLIGHT

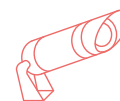

601

ANDROMEDA

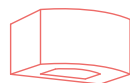

595

STYLE



602

DJAMBE



596

TAURUS



603

GUN

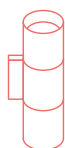

596

TECHO



605

IPOTESI

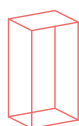

597

TESLA



605

JEDI



597

VEGA



606

LOLITA



598

SIRIO



598

SOLE



599

BEAN

DA PARETE



IP20



FOTO p. 152

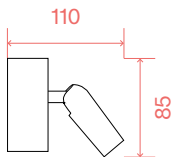

FINITURA	CODICE	€
Bianco	260648	48
Nickel	260679	48
Nero	260655	48
Ottone	260662	48

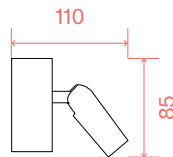

FINITURA	CODICE	€
Bianco	260600	48
Nickel	260631	48
Nero	260617	48
Ottone	260624	48

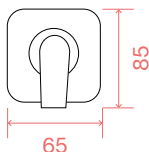

Sorgente luminosa LED
3000 K, 30.000 h di durata.

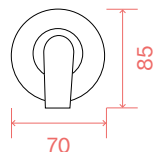

Sorgente luminosa LED
3000 K, 30.000 h di durata.

0,180 Kg
0,0008 m³
LED 3W / 280 lm

0,180 Kg
0,0005 m³
LED 3W / 280 lm

BIRDS

SOSPENSIONE



IP20

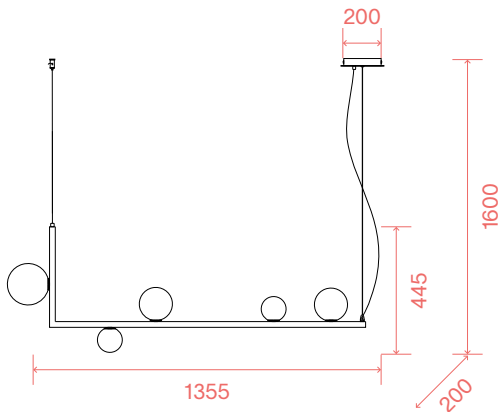

(CONSIGLIATA)

LUMEN	CCT	CODICE	€
510 lm	3000 K	305486	6

FINITURA	CODICE	€
Nero	273648	283

Lampadine LED G9 4W 3000 K
includ. Cod. 209043

2,750 Kg
0,1353 m³
G9 max 5 x 15W

BIRDS

DA SOFFITTO



IP20

↑ FOTO p. 122

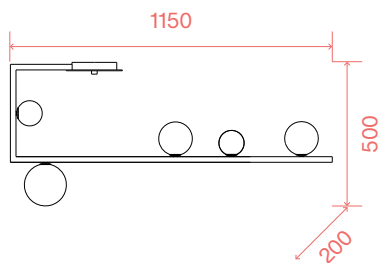

2,800 Kg
0,1535 m³
G9 max 5 x 15W

(CONSIGLIATA)

LUMEN	CCT	CODICE	€
510 lm	3000 K	305486	6

FINITURA	CODICE	€
Nero	273631	278



Lampadine LED G9 4W 3000 K
includ. Cod. 209043

DA PARETE



IP20

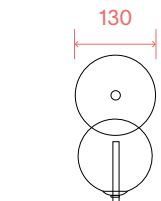
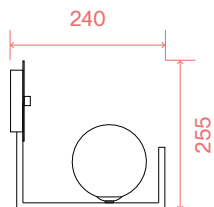

0,670 Kg
0,0192 m³
G9 max 1 x 15W

(CONSIGLIATA)

LUMEN	CCT	CODICE	€
510 lm	3000 K	305486	6

FINITURA	CODICE	€
Nero	273655	73



Lampadine LED G9 4W 3000 K
includ. Cod. 209043

DA TAVOLO



IP20

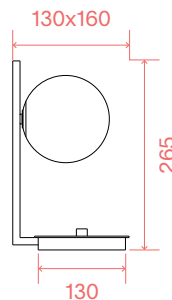

0,900 Kg
0,0163 m³
G9 max 1 x 15W

(CONSIGLIATA)

LUMEN	CCT	CODICE	€
510 lm	3000 K	305486	6

FINITURA	CODICE	€
Nero	273679	86



Lampadine LED G9 4W 3000 K
includ. Cod. 209043



BIRDS

DA TERRA

 IP20  **FOTO** p. 238

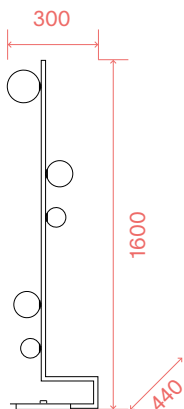

(CONSIGLIATA)

LUMEN	CCT	CODICE	€
510 lm	3000 K	305486	6

FINITURA	CODICE	€
Nero	273662	340



 Lampadine LED G9 4W 3000 K
includ. Cod. 209043



5,640 Kg
0,1536 m³
G9 max 5 x 15W

CLIP

DA PARETE

 IP20  **FOTO** p. 156

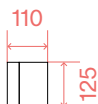

1,210 Kg
0,0161 m³
E27 max 2 x 60W

(CONSIGLIATA)

LUMEN	CCT	CODICE	€
430 lm	3000 K	101279	2,60

FINITURA	CODICE	€
Bianco	014166	107
Argento	088273	107
Cromo	031361	107
Oro	088266	107
Coffee	187365	107

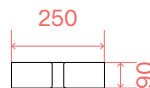

0,680 Kg
0,0035 m³
G9 max 2 x 40W

(CONSIGLIATA)

LUMEN	CCT	CODICE	€
510 lm	3000 K	305486	6

FINITURA	CODICE	€
Bianco	049236	95
Argento	091136	95
Cromo	049229	95
Oro	091129	95
Coffee	170923	95

 Lampadine LED G9 4W 3000 K
includ. Cod. 209043

COVER

DA PARETE / SOFFITTO  IP20  FOTO p. 160

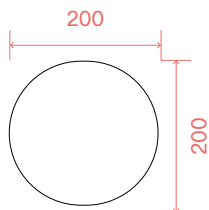

FINITURA	CODICE	€
Bianco	195711	100
Nero	088273	100

 Sorgente luminosa LED
3000 K, 30.000 h di durata.

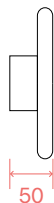

0,690 Kg
0,0028 m³
LED 11W / 1000 lm

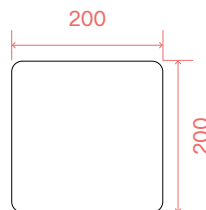

FINITURA	CODICE	€
Bianco	195735	100
Nero	195773	100

 Sorgente luminosa LED
3000 K, 30.000 h di durata.

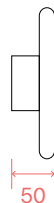

0,860 Kg
0,0028 m³
LED 11W / 1000 lm

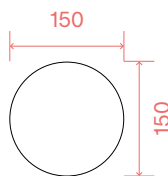

FINITURA	CODICE	€
Bianco	195704	88
Nero	195742	88

 Sorgente luminosa LED
3000 K, 30.000 h di durata.

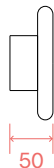

0,390 Kg
0,0018 m³
LED 9,5W / 830 lm

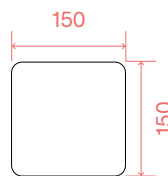

FINITURA	CODICE	€
Bianco	195728	88
Nero	195766	88

 Sorgente luminosa LED
3000 K, 30.000 h di durata.

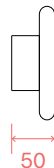

0,510 Kg
0,0018 m³
LED 9,5W / 830 lm

DELTA

DA PARETE



IP20



FOTO p. 166

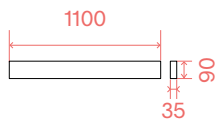

2,400 Kg
0,0102 m³
LED 37W
4550/4800 lm

FINITURA	CCT	CODICE	€
Bianco	3000 K	287607	185
Bianco	4000 K	307053	185
Nero	3000 K	287591	185
Nero	4000 K	307060	185



Sorgente luminosa LED
3000/4000 K, 50.000 h
di durata.

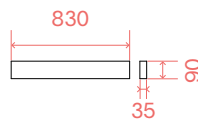

0,900 Kg
0,0078 m³
LED 30W
3600/3800 lm

FINITURA	CCT	CODICE	€
Bianco	3000 K	287621	160
Bianco	4000 K	307039	160
Nero	3000 K	287614	160
Nero	4000 K	307046	160



Sorgente luminosa LED
3000/4000 K, 50.000 h
di durata.

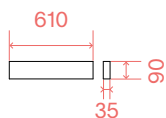

0,950 Kg
0,0058 m³
LED 19,5W
2050/2150 lm

FINITURA	CCT	CODICE	€
Bianco	3000 K	287645	110
Bianco	4000 K	307015	110
Nero	3000 K	287638	110
Nero	4000 K	307022	110



Sorgente luminosa LED
3000/4000 K,
50.000 h di durata.

DIESIS

SOSPENSIONE



IP20

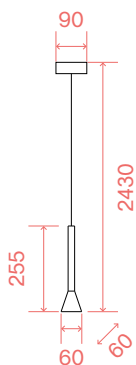

0,450 Kg
0,0054 m³
LED 7W / 580 lm

FINITURA	CODICE	€
Nickel	285122	96
Nero	279770	96
Ottone	279794	96



Sorgente luminosa LED
3000 K, 20.000 h di durata.

DA TAVOLO



IP20

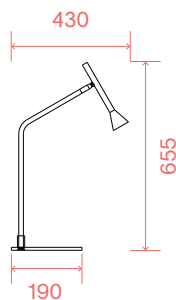

1,700 Kg
0,0637 m³
LED 6,5W / 500 lm

FINITURA	CODICE	€
Nickel	291093	185
Nero	283333	185
Ottone	291109	185



Sorgente luminosa LED
3000 K, 30.000 h di durata.



DIESIS

DA TERRA



IP20



FOTO p. 244

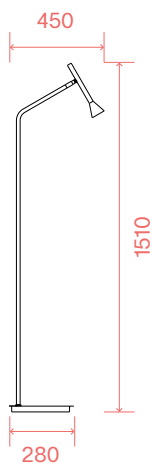

FINITURA	CODICE	€
Nickel	285337	205
Nero	279800	205
Ottone	285344	205



Sorgente luminosa LED
3000 K, 20.000 h di durata.



3,500 Kg
0,0222 m³
LED 4,5W / 300 lm

DORSALE

DA TERRA



IP20



FOTO p. 252

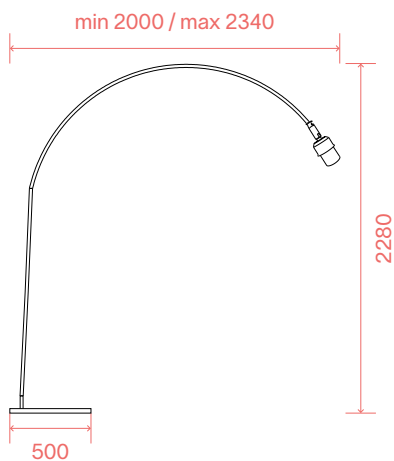

12,000 Kg
0,0856 m³
E27 max 1 x 60W

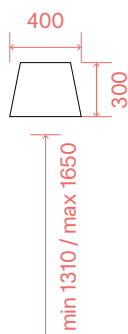

0,430 Kg
0,0709 m³

(CONSIGLIATA)

LUMEN	CCT	CODICE	€
1050 lm	3000 K	101347	8

FINITURA	CODICE	€
Bianco	286686	600
Cromo	286662	600
Nero	286679	600



PARALUME

FINITURA	CODICE	€
Bianco	046723	75
Cromo	041742	75
Nero	046471	75

DOT

DA SOFFITTO



IP20



FOTO p. 126

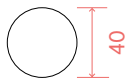
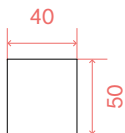

FINITURA	CCT	CODICE	€
Bianco	3000 K	299419	45
Bianco	4000 K	306513	45
Nero	3000 K	299402	45
Nero	4000 K	306520	45



Sorgente luminosa LED
3000/4000 K, 50.000 h di
durata.

0,600 Kg
0,0004 m³
LED 4W / 320/370 lm

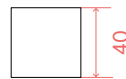
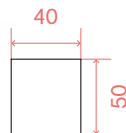

FINITURA	CCT	CODICE	€
Bianco	3000 K	319797	67
Nero	3000 K	319803	67



Sorgente luminosa LED
3000/4000 K, 50.000 h di
durata.

0,100 Kg
0,0004 m³
LED 4W / 320/370 lm

DYNAMITE

DA PARETE / SOFFITTO



IP20



FOTO p. 130

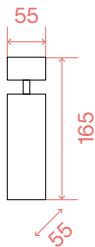

(CONSIGLIATA)

LUMEN	CCT	CODICE	€
540 lm	3000 K	123943	3,50

FINITURA	CODICE	€
Bianco	231495	98
Nero	231471	98
Ottone	244662	98



Lampadine LED GU10 7W
3000 K incluse. Cod. 123943

0,430 Kg
0,0037 m³
GU10 max 1 x 28W

DYNAMITE

SOSPENSIONE



IP20

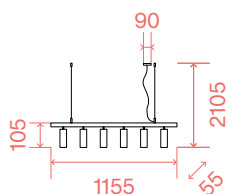

(CONSIGLIATA)

LUMEN	CCT	CODICE	€
540 lm	3000 K	123943	3,50

FINITURA	CODICE	€
Bianco	231433	350
Nero	231396	350
Ottone	244648	350

2,700 Kg
0,0360 m³
GU10 max 6 x 28W

Lampadine LED GU10 7W
3000 K incluse. Cod. 123943

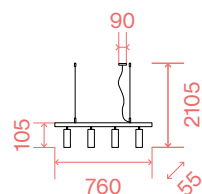

(CONSIGLIATA)

LUMEN	CCT	CODICE	€
540 lm	3000 K	123943	3,50

FINITURA	CODICE	€
Bianco	231372	275
Nero	231341	275
Ottone	244624	275

2,310 Kg
0,0243 m³
GU10 max 4 x 28W

Lampadine LED GU10 7W
3000 K incluse. Cod. 123943

EQUINOXE

SOSPENSIONE



IP20

↑ FOTO p. 16

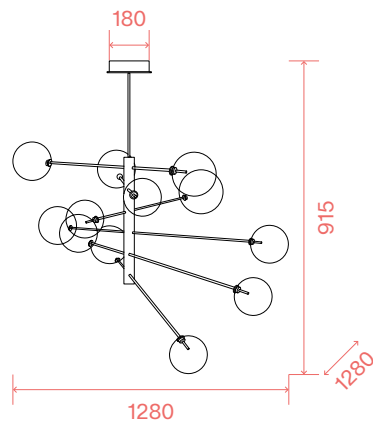

(CONSIGLIATA)

LUMEN	CCT	CODICE	€
200 lm	3000 K	222257	4

FINITURA	CODICE	€
Cromo	200118	950
Ottone	200125	950

Lampadine LED G4 2W 3000 K
includ. Cod. 222257

5,540 Kg
0,1304 m³
G4 max 12 x 2W

EQUINOXE

SOSPENSIONE



IP20

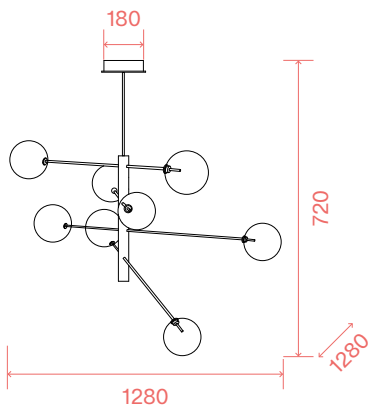

4,460 Kg
0,1427 m³
G4 max 8 x 2W

(CONSIGLIATA)

LUMEN	CCT	CODICE	€
200 lm	3000 K	222257	4

FINITURA	CODICE	€
Cromo	275178	750
Ottone	275215	750

Lampadine LED G4 2W 3000 K
includ. Cod. 222257

SOSPENSIONE



IP20

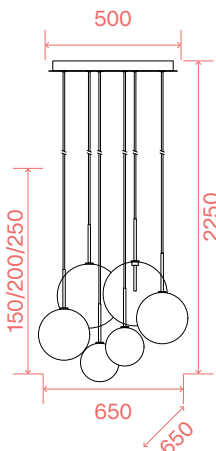

5,200 Kg
0,1274 m³
G4 max 6 x 2W

(CONSIGLIATA)

LUMEN	CCT	CODICE	€
200 lm	3000 K	222257	4

FINITURA	CODICE	€
Cromo	317250	650
Ottone	317243	650

Lampadine LED G4 2W 3000 K
includ. Cod. 222257

(CONSIGLIATA)

LUMEN	CCT	CODICE	€
200 lm	3000 K	222257	4

FINITURA	CODICE	€
Cromo	306551	180
Ottone	277394	180

Lampadine LED G4 2W 3000 K
includ. Cod. 222257

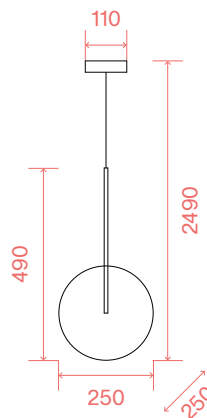

0,850 Kg
0,0326 m³
G4 max 1 x 2W

EQUINOXE

SOSPENSIONE



IP20

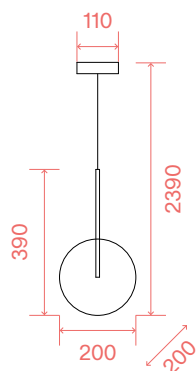

(CONSIGLIATA)

LUMEN	CCT	CODICE	€
200 lm	3000 K	222257	4

FINITURA	CODICE	€
Cromo	306544	140
Ottone	277387	140

Lampadine LED G4 2W 3000 K incluse. Cod. 222257

0,700 Kg
0,0211 m³
G4 max 1 x 2W

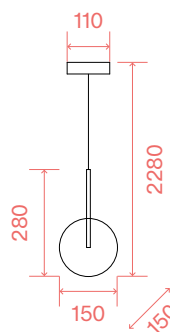

(CONSIGLIATA)

LUMEN	CCT	CODICE	€
200 lm	3000 K	222257	4

FINITURA	CODICE	€
Cromo	306537	120
Ottone	277370	120

Lampadine LED G4 2W 3000 K incluse. Cod. 222257

0,640 Kg
0,0170 m³
G4 max 1 x 2W

DA PARETE



IP20

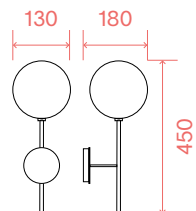

(CONSIGLIATA)

LUMEN	CCT	CODICE	€
200 lm	3000 K	222257	4

FINITURA	CODICE	€
Cromo	200132	131
Ottone	200149	131

Lampadine LED G4 2W 3000 K incluse. Cod. 222257

0,990 Kg
0,0243 m³
G4 max 1 x 2W

DA TERRA



IP20

FOTO p. 258

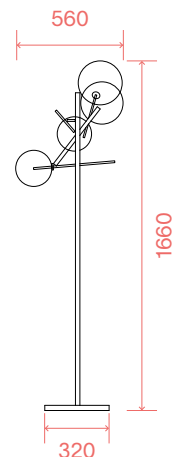

(CONSIGLIATA)

LUMEN	CCT	CODICE	€
200 lm	3000 K	222257	4

FINITURA	CODICE	€
Cromo	290959	500
Ottone	290966	500

Lampadine LED G4 2W 3000 K incluse. Cod. 222257



6,500 Kg
0,0882 m³
G4 max 4 x 2W

ESSENCE

SOSPENSIONE



IP20

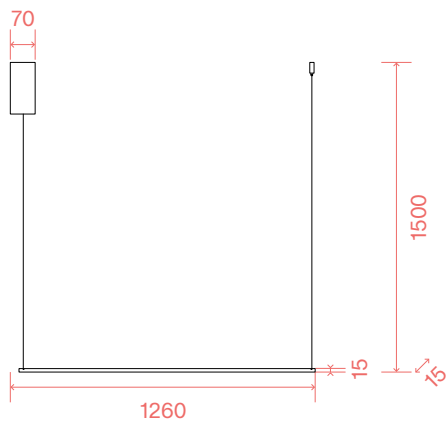

FINITURA	CODICE	€
Bianco	285085	275
Nero	285092	275

Sorgente luminosa LED
3000 K, 30.000 h di durata.

0,900 Kg
0,0165 m³
LED 20W / 2650 lm

DA PARETE / SOFFITTO



IP20



FOTO p. 172

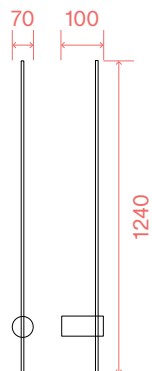

FINITURA	CODICE	€
Bianco	265575	240
Nero	285108	240

Sorgente luminosa LED
3000 K, 30.000 h di durata.

1,040 Kg
0,0163 m³
LED 20W / 2650 lm

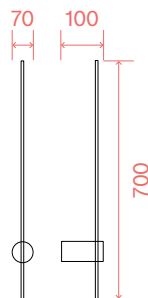

FINITURA	CODICE	€
Bianco	285115	182
Nero	265643	182

Sorgente luminosa LED
3000 K, 30.000 h di durata.

0,800 Kg
0,0205 m³
LED 12,5W / 1650 lm

FADE

SOSPENSIONE



IP20



FOTO p. 20

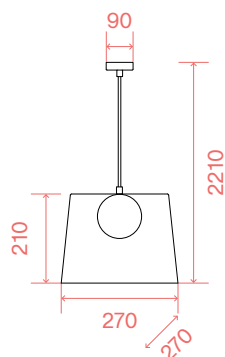

(CONSIGLIATA)

LUMEN	CCT	CODICE	€
510 lm	3000 K	305486	6

FINITURA	CODICE	€
Cromo	271293	200
Ambra	271316	200
Rame	271309	200



Lampadine LED G9 4W 3000 K
includ. Cod. 209043

1,900 Kg
0,0370 m³
G9 max 1 x 15W

FILO

SOSPENSIONE



IP20



FOTO p. 26

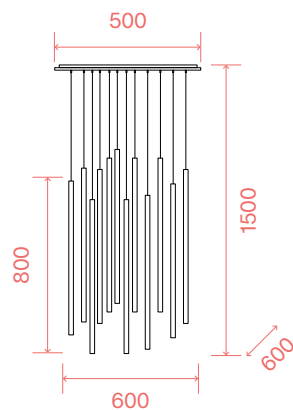

FINITURA	CODICE	€
Bianco	263441	690
Nero	263434	690
Ottone	263663	690



Sorgente luminosa LED
3000 K, 30.000 h di durata.

8,600 Kg
0,1232 m³
LED 25W / 3150 lm

FILO

SOSPENSIONE



IP20



IP20

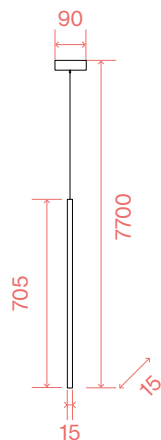

FINITURA	CODICE	€
Bianco	300818	180
Nero	300801	180
Ottone	300825	180

Sorgente luminosa LED
3000 K, 20.000 h di durata.

0,830 Kg
0,0105 m³
LED 4W / 160 lm

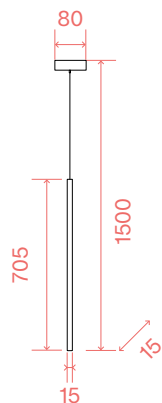

FINITURA	CODICE	€
Bianco	263687	125
Nero	263670	125
Ottone	263700	125

Sorgente luminosa LED
3000 K, 30.000 h di durata.

0,530 Kg
0,0142 m³
LED 3,5W / 230 lm

DA PARETE / SOFFITTO



IP44

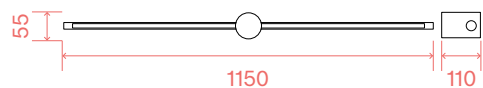

FINITURA	CODICE	€
Bianco	327778	200
Nero	310152	200
Ottone	327785	200

Sorgente luminosa LED
3000 K, 20.000 h di durata.



IP44

0,610 Kg
0,0138 m³
LED 16W / 2000 lm

FILO

DA PARETE / SOFFITTO  IP44

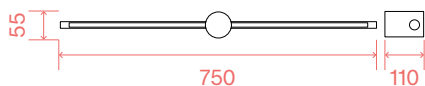

0,500 Kg
0,0093 m³
LED 12,5W / 1450 lm

FINITURA	CODICE	€
Bianco	310138	180
Nero	310145	180
Ottone	327792	180

 Sorgente luminosa LED
3000 K, 20.000 h di durata.



DA TERRA  IP20  FOTO p. 264

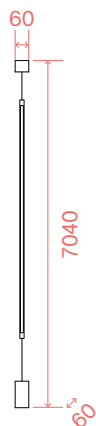

FINITURA	CODICE	€
Bianco	301051	250
Nero	301068	250
Ottone	301075	250

 Sorgente luminosa LED
3000 K, 20.000 h di durata.



1,200 Kg
0,0124 m³
LED 15W / 1900 lm

DA TAVOLO  IP20



FINITURA	CODICE	€
Bianco	310107	150
Nero	310114	150
Ottone	310121	150

 Sorgente luminosa LED
3000 K, 20.000 h di durata.



0,500 Kg
0,0204 m³
LED 10,5W / 1200 lm

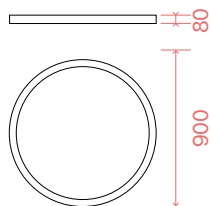

6,900 Kg
0,0903 m³

KIT PENDANT
(OPTIONAL)

Bianco
cod. 254289, € 50
Nero
cod. 307244, € 50

LED SMD SAMSUNG, DRIVER TRIDONIC ON/OFF (INCLUSO)

POTENZA	ANGOLO	LUMEN	CCT	FINITURA	CODICE	€
65 W	87°	9400 lm	3000 K	Bianco	270326	1180
65 W	87°	9400 lm	3000 K	Nero	306629	1180
65 W	87°	9900 lm	4000 K	Bianco	270241	1180
65 W	87°	9900 lm	4000 K	Nero	306636	1180

DIMMABLE DRIVER (NON INCLUSO/OPTIONAL)

	POTENZA	OUTPUT	MISURE	CODICE	€
1-10V	68 W	1400 mA	130 x 25 x 75 mm	270357	125
DALI / Push	100 W	1400 mA	140 x 30 x 100 mm	270388	180

UPLIGHT (NON INCLUSO/OPTIONAL)

POTENZA	ANGOLO	LUMEN	CCT	CODICE	€
25 W	120°	3650 lm	3000 K	271002	225
25 W	120°	3850 lm	4000 K	270715	225

LED SMD SAMSUNG, DRIVER TRIDONIC ON/OFF (INCLUSO)

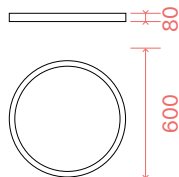

4,500 Kg
0,0423 m³

KIT PENDANT
(OPTIONAL)

Bianco
cod. 254289, € 50
Nero
cod. 307244, € 50

DIMMABLE DRIVER (NON INCLUSO/OPTIONAL)

	POTENZA	OUTPUT	MISURE	CODICE	€
1-10V	60 W	1400 mA	124 x 23 x 82 mm	270340	112
DALI / Push	60 W	1400 mA	125 x 28 x 85 mm	270371	135

UPLIGHT (NON INCLUSO/OPTIONAL)

POTENZA	ANGOLO	LUMEN	CCT	CODICE	€
18 W	120°	2650 lm	3000 K	270401	150
18 W	120°	2750 lm	4000 K	270265	150

FLY

DA PARETE / SOFFITTO  IP40 MacAdam: SDCM 3 UGR: <19 CRI >80 Durata LED: 50.000 h

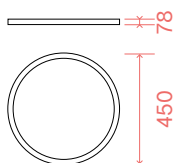

3,700 Kg
0,0250 m³

KIT PENDANT
(OPTIONAL)
Bianco
cod. 254289, € 50
Nero
cod. 307244, € 50

LED SMD SAMSUNG, DRIVER TRIDONIC ON/OFF (INCLUSO)

POTENZA	ANGOLO	LUMEN	CCT	FINITURA	CODICE	€
26 W	87°	3700 lm	3000 K	Bianco	254272	420
26 W	87°	3700 lm	3000 K	Nero	306599	420
26 W	87°	3900 lm	4000 K	Bianco	270296	420
26 W	87°	3900 lm	4000 K	Nero	306605	420

DIMMABLE DRIVER (NON INCLUSO/OPTIONAL)

	POTENZA	OUTPUT	MISURE	CODICE	€
1-10V / Push	32 W	700 mA	94 x 21 x 67 mm	270586	75
DALI / Push	38 W	700 mA	94 x 21 x 67 mm	270593	95

UPLIGHT (NON INCLUSO/OPTIONAL)

POTENZA	ANGOLO	LUMEN	CCT	CODICE	€
12 W	120°	1600 lm	3000 K	270258	85
12 W	120°	1700 lm	4000 K	270395	85

LED SMD SAMSUNG, DRIVER TRIDONIC ON/OFF (INCLUSO)

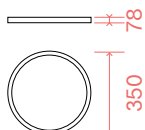

3,000 Kg
0,0160 m³

KIT PENDANT
(OPTIONAL)
Bianco
cod. 254289, € 50
Nero
cod. 307244, € 50

POTENZA	ANGOLO	LUMEN	CCT	FINITURA	CODICE	€
18 W	87°	2650 lm	3000 K	Bianco	270272	315
18 W	87°	2650 lm	3000 K	Nero	306575	315
18 W	87°	2800 lm	4000 K	Bianco	270289	315
18 W	87°	2800 lm	4000 K	Nero	306582	315

DIMMABLE DRIVER (NON INCLUSO/OPTIONAL)

	POTENZA	OUTPUT	MISURE	CODICE	€
1-10V / Push	20 W	500 mA	108 x 22 x 52 mm	270333	65
DALI	20 W	500 mA	108 x 22 x 52 mm	270364	85

UPLIGHT (NON INCLUSO/OPTIONAL)

POTENZA	ANGOLO	LUMEN	CCT	CODICE	€
12 W	120°	1600 lm	3000 K	270258	85
12 W	120°	1700 lm	4000 K	270395	85

FLY SLIM

DA PARETE / SOFFITTO  IP40 MacAdam: SDCM 3 UGR: <19 CRI >80 Durata LED: 50.000 h

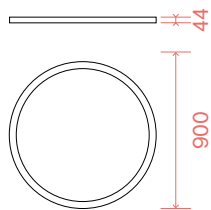

13,000 Kg
0,1448 m³

KIT PENDANT
(OPTIONAL)
Bianco
cod. 254289, € 50

LED SMD SAMSUNG, DRIVER TRIDONIC ON/OFF (INCLUSO)

POTENZA	ANGOLO	LUMEN	CCT	FINITURA	CODICE	€
65 W	87°	9400 lm	3000 K	Bianco	306681	1125
65 W	87°	9900 lm	4000 K	Bianco	306698	1125

DIMMABLE DRIVER (NON INCLUSO/OPTIONAL)

	POTENZA	OUTPUT	MISURE	CODICE	€
1-10V	68 W	1400 mA	130 x 25 x 75 mm	270357	125
DALI / Push	100 W	1400 mA	140 x 30 x 100 mm	270388	180

UPLIGHT (NON INCLUSO/OPTIONAL)

POTENZA	ANGOLO	LUMEN	CCT	CODICE	€
25 W	120°	3650 lm	3000 K	271002	225
25 W	120°	3850 lm	4000 K	270715	225

LED SMD SAMSUNG, DRIVER TRIDONIC ON/OFF (INCLUSO)

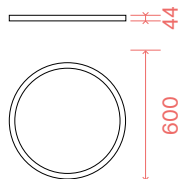

5,800 Kg
0,0699 m³

KIT PENDANT
(OPTIONAL)
Bianco
cod. 254289, € 50

POTENZA	ANGOLO	LUMEN	CCT	FINITURA	CODICE	€
53 W	87°	7500 lm	3000 K	Bianco	292250	575
53 W	87°	8000 lm	4000 K	Bianco	306674	575

DIMMABLE DRIVER (NON INCLUSO/OPTIONAL)

	POTENZA	OUTPUT	MISURE	CODICE	€
1-10V	60 W	1400 mA	124 x 23 x 82 mm	270340	112
DALI / Push	60 W	1400 mA	125 x 28 x 85 mm	270371	135

UPLIGHT (NON INCLUSO/OPTIONAL)

POTENZA	ANGOLO	LUMEN	CCT	CODICE	€
18 W	120°	2650 lm	3000 K	270401	150
18 W	120°	2750 lm	4000 K	270265	150

FLY SLIM

DA PARETE / SOFFITTO  IP40 MacAdam: SDCM 3 UGR: <19 CRI >80 Durata LED: 50.000 h

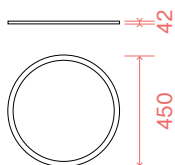

3,750 Kg
0,0170 m³

KIT PENDANT
(OPTIONAL)
Bianco
cod. 254289, € 50

LED SMD SAMSUNG, DRIVER TRIDONIC ON/OFF (INCLUSO)

POTENZA	ANGOLO	LUMEN	CCT	FINITURA	CODICE	€
26 W	87°	3700 lm	3000 K	Bianco	292236	390
26 W	87°	3900 lm	4000 K	Bianco	306667	390

DIMMABLE DRIVER (NON INCLUSO/OPTIONAL)

	POTENZA	OUTPUT	MISURE	CODICE	€
1-10V / Push	32 W	700 mA	94 x 21 x 67 mm	270586	75
DALI / Push	38 W	700 mA	94 x 21 x 67 mm	270593	95

UPLIGHT (NON INCLUSO/OPTIONAL)

POTENZA	ANGOLO	LUMEN	CCT	CODICE	€
12 W	120°	1600 lm	3000 K	270258	85
12 W	120°	1700 lm	4000 K	270395	85

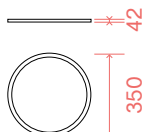

2,700 Kg
0,0105 m³

KIT PENDANT
(OPTIONAL)
Bianco
cod. 254289, € 50

LED SMD SAMSUNG, DRIVER TRIDONIC ON/OFF (INCLUSO)

POTENZA	ANGOLO	LUMEN	CCT	FINITURA	CODICE	€
18 W	87°	2650 lm	3000 K	Bianco	306643	295
18 W	87°	2800 lm	4000 K	Bianco	306650	295

DIMMABLE DRIVER (NON INCLUSO/OPTIONAL)

	POTENZA	OUTPUT	MISURE	CODICE	€
1-10V / Push	20 W	500 mA	108 x 22 x 52 mm	270333	65
DALI	20 W	500 mA	108 x 22 x 52 mm	270364	85

UPLIGHT (NON INCLUSO/OPTIONAL)

POTENZA	ANGOLO	LUMEN	CCT	CODICE	€
12 W	120°	1600 lm	3000 K	270258	85
12 W	120°	1700 lm	4000 K	270395	85

FOCUS

DA PARETE



IP20



FOTO p. 178

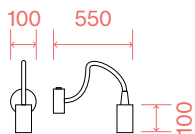

FINITURA	CODICE	€
Bianco	097183	71
Cromo	097206	71
Nero	097190	71

0,400 Kg
0,0025 m³
LED 4W / 210 lm



Sorgente luminosa LED
3000 K, 30.000 h di durata.

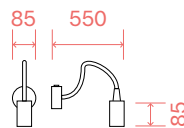

FINITURA	CODICE	€
Bianco	203171	75
Cromo	203188	75
Nero	203195	75

0,410 Kg
0,0020 m³
LED 3,5W / 280 lm



Sorgente luminosa LED
3000 K, 20.000 h di durata.



FRAME

SOSPENSIONE



IP20



FOTO p. 30

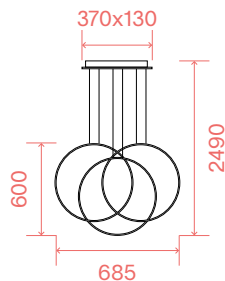

FINITURA	CODICE	€
Bianco	269351	355
Nero	269337	355



Sorgente luminosa LED
3000 K, 30.000 h di durata.

3,500 Kg
0,1050 m³
LED 82W / 7300 lm

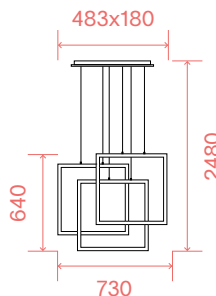

FINITURA	CODICE	€
Bianco	253596	555
Nero	269375	555



Sorgente luminosa LED
3000 K, 30.000 h di durata.

4,270 Kg
0,0689 m³
LED 80W / 9100 lm

FRAME

SOSPENSIONE



IP20

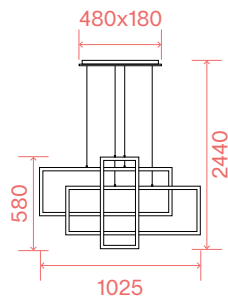

FINITURA	CODICE	€
Bianco	253589	550
Nero	269382	550

Sorgente luminosa LED
3000 K, 30.000 h di durata.

4,300 Kg
0,2100 m³
LED 93W / 10700 lm

DA PARETE / SOFFITTO



IP20

↑ FOTO p. 142

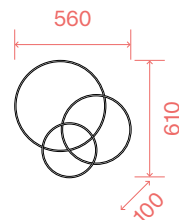

FINITURA	CODICE	€
Bianco	255019	320
Nero	269825	320

Sorgente luminosa LED
3000 K, 30.000 h di durata.

1,600 Kg
0,0458 m³
LED 41W / 5250 lm

DA PARETE / SOFFITTO



IP20

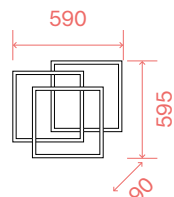

FINITURA	CODICE	€
Bianco	230702	320
Nero	270678	320

Sorgente luminosa LED
3000 K, 30.000 h di durata.

1,430 Kg
0,0530 m³
LED 35W / 4950 lm

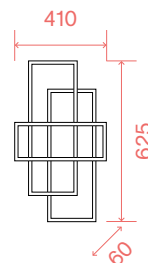

FINITURA	CODICE	€
Bianco	230726	290
Nero	270661	290

Sorgente luminosa LED
3000 K, 30.000 h di durata.

1,240 Kg
0,0264 m³
LED 31W / 4250 lm

FRAME

DA TERRA



IP20

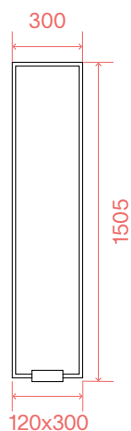

FINITURA	CODICE	€
Bianco	299624	450
Nero	299617	450

Sorgente luminosa LED
3000 K, 30.000 h di durata.



10,300 Kg
0,0525 m³
LED 30W / 3000 lm

FUTURA

DA TAVOLO



IP20

FOTO p. 198

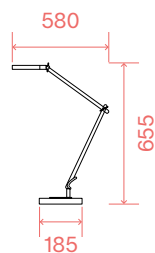

FINITURA	CODICE	€
Bianco	272078	130
Alluminio	204895	130
Nero	204888	130

Sorgente luminosa LED
4000 K, 25.000 h di durata.



1,830 Kg
0,0069 m³
LED 12,5W / 1100 lm

DA TERRA



IP20

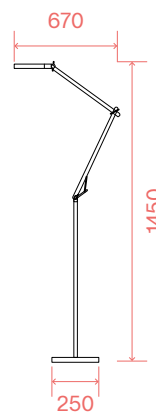

FINITURA	CODICE	€
Bianco	272085	190
Alluminio	204956	190
Nero	204949	190

Sorgente luminosa LED
4000 K, 25.000 h di durata.



4,440 Kg
0,0095 m³
LED 12,5W / 1100 lm

GEMINI

SOSPENSIONE



ON-OFF



DALI/PUSH IP20



FOTO p. 38

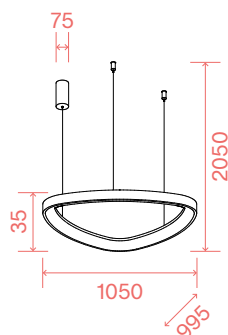

ON-OFF

FINITURA	CODICE	€
Bianco	303895	650
Nero	307695	650
Ottone	307701	650



Sorgente luminosa LED
3000 K, 50.000 h di durata.

3,100 Kg
0,1134 m³
LED 82W / 10000 lm

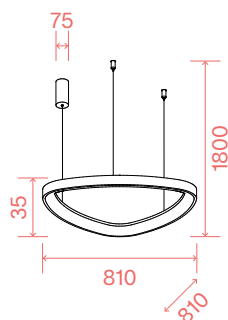

ON-OFF

FINITURA	CODICE	€
Bianco	247274	430
Nero	247281	430
Ottone	269849	430

DALI/PUSH

FINITURA	CODICE	€
Bianco	304748	525
Nero	304724	525
Ottone	304731	525

2,060 Kg
0,0774 m³
LED 55W / 6600 lm



Sorgente luminosa LED
3000 K, 50.000 h di durata.

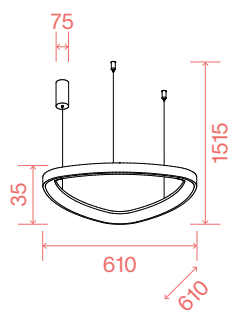

ON-OFF

FINITURA	CODICE	€
Bianco	247250	330
Nero	247267	330
Ottone	269832	330

DALI/PUSH

FINITURA	CODICE	€
Bianco	304717	425
Nero	304694	425
Ottone	304700	425

1,710 Kg
0,0462 m³
LED 48W / 6600 lm



Sorgente luminosa LED
3000 K, 50.000 h di durata.

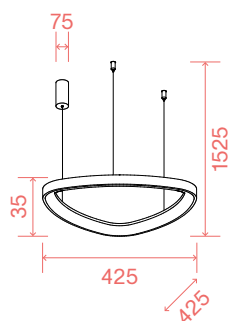

ON-OFF

FINITURA	CODICE	€
Bianco	247229	240
Nero	247236	240
Ottone	247243	240



Sorgente luminosa LED
3000 K, 50.000 h di durata.

1,290 Kg
0,0230 m³
LED 38W / 5100 lm

GEMINI

DA PARETE / SOFFITTO  ON-OFF  DALI/PUSH IP20

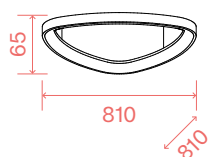

ON-OFF

FINITURA	CODICE	€
Bianco	328072	390
Nero	328089	390
Ottone	328096	390

4,800 Kg
0,0919 m³
LED 41W / 5700 lm

DALI/PUSH

FINITURA	CODICE	€
Bianco	328973	480
Nero	328980	480
Ottone	329260	480

 Sorgente luminosa LED
3000 K, 30.000 h di durata.

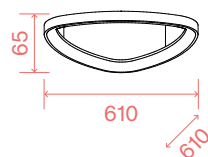

ON-OFF

FINITURA	CODICE	€
Bianco	328041	300
Nero	328058	300
Ottone	328065	300

3,200 Kg
0,0507 m³
LED 27W / 3850 lm

DALI/PUSH

FINITURA	CODICE	€
Bianco	328942	380
Nero	328959	380
Ottone	328966	380

 Sorgente luminosa LED
3000 K, 30.000 h di durata.

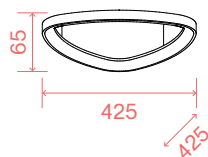

ON-OFF

FINITURA	CODICE	€
Bianco	328010	220
Nero	328027	220
Ottone	328034	220

1,900 Kg
0,0271 m³
LED 23W / 3200 lm

 Sorgente luminosa LED
3000 K, 30.000 h di durata.



PROIETTORE



IP20



FOTO p. 44

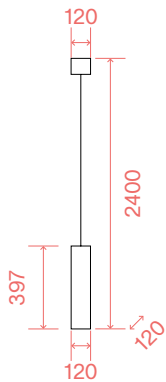

2,950 Kg
0,0092 m³
GU10 max 1 x 50W

(CONSIGLIATA)

LUMEN	CCT	CODICE	€
800 lm	3000 K	189031	15

FINITURA	CODICE	€
Nero	158723	132



Lampadine LED GU10 10W
3000 K include. Cod. 189031

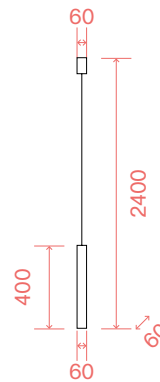

0,990 Kg
0,0029 m³
GU10 max 1 x 28W

(CONSIGLIATA)

LUMEN	CCT	CODICE	€
540 lm	3000 K	123943	3,50

FINITURA	CODICE	€
Bianco	104935	72
Cromo	104942	72
Nero	104928	72
Trasparente	194806	95
Argento	141800	95
Nickel	313894	95
Oro	141817	95
Ottone	259239	95
Brunito	141794	95
Rame	141855	95
Coffee	170589	95



Lampadine LED GU10 7W
3000 K include. Cod. 123943

DA SOFFITTO



IP20

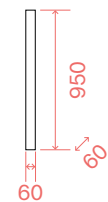

3,070 Kg
0,0061 m³
GU10 max 1 x 28W

(CONSIGLIATA)

LUMEN	CCT	CODICE	€
540 lm	3000 K	123943	3,50

FINITURA	CODICE	€
Bianco	259260	86
Nero	259277	86



Lampadine LED GU10 7W
3000 K include. Cod. 123943

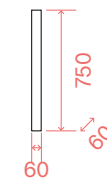

1,380 Kg
0,0037 m³
GU10 max 1 x 28W

(CONSIGLIATA)

LUMEN	CCT	CODICE	€
540 lm	3000 K	123943	3,50

FINITURA	CODICE	€
Bianco	233352	60
Nero	233321	60



Lampadine LED GU10 7W
3000 K include. Cod. 123943

DA SOFFITTO



IP20

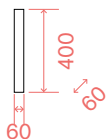

0,740 Kg
0,0025 m³
GU10 max 1 x 28W

(CONSIGLIATA)

LUMEN	CCT	CODICE	€
540 lm	3000 K	123943	3,50

FINITURA	CODICE	€
Bianco	233215	48
Nero	233192	48

Lampadine LED GU10 7W
3000 K incluse. Cod. 123943

(CONSIGLIATA)

LUMEN	CCT	CODICE	€
540 lm	3000 K	123943	3,50

FINITURA	CODICE	€
Bianco	233079	38
Nero	285214	38
Ottone	233062	38

Lampadine LED GU10 7W
3000 K incluse. Cod. 123943

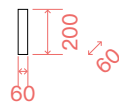

0,400 Kg
0,0013 m³
GU10 max 1 x 28W

DA PARETE



IP20

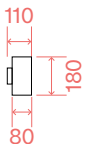

0,500 Kg
0,0028 m³
GU10 max 2 x 28W

(CONSIGLIATA)

LUMEN	CCT	CODICE	€
540 lm	3000 K	123943	3,50

FINITURA	CODICE	€
Bianco	096018	80
Cromo	094182	80
Nero	095998	80
Rame	164847	80
Brunito	164823	80

Lampadine LED GU10 7W
3000 K incluse. Cod. 123943

DA TERRA



IP20

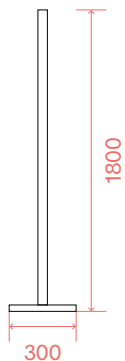

5,080 Kg
0,0809 m³
LED 24W / 2950 lm

FINITURA	CODICE	€
Bianco	304922	240
Nero	304915	240

Sorgente luminosa LED
3000 K, 30.000 h di durata.



LOOK

PER BINARI



IP20

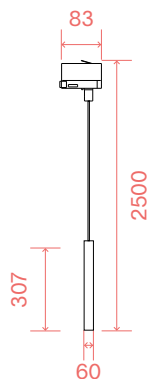

(CONSIGLIATA)

LUMEN	CCT	CODICE	€
540 lm	3000 K	123943	3,50

FINITURA	CODICE	€
Bianco	231662	83
Nero	231631	83

Lampadine LED GU10 7W
3000 K incluse. Cod. 123943

SINGLE CONNECTION

NECESSARIO	DRIVER
no	on/off

FINITURA	CODICE	€
Bianco	170145	27
Nero	170152	27

0,930 Kg
0,0037 m³
GU10 max 1 x 28W

MAPA BIANCO

SOSPENSIONE



IP20

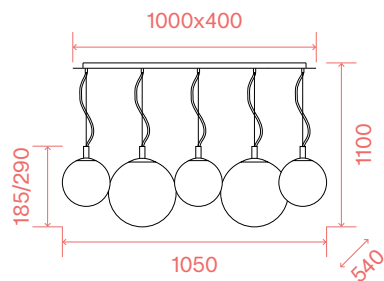

(CONSIGLIATA)

LUMEN	CCT	CODICE	€
910 lm	3000 K	119571	6

FINITURA	CODICE	€
Bianco	043562	530

8,700 Kg
0,2470 m³
E27 max 5 x 60W

MAPA BIANCO

SOSPENSIONE



IP20



FOTO p. 52

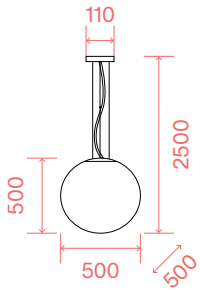

(CONSIGLIATA)

LUMEN	CCT	CODICE	€
910 lm	3000 K	119571	6
FINITURA		CODICE	€
Bianco		032122	303

5,390 Kg
0,2254 m³
E27 max 1 x 60W

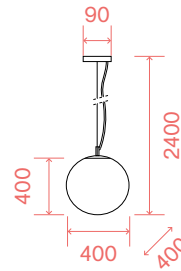

(CONSIGLIATA)

LUMEN	CCT	CODICE	€
910 lm	3000 K	119571	6
FINITURA		CODICE	€
Bianco		032139	145

3,620 Kg
0,1215 m³
E27 max 1 x 60W

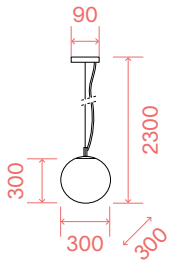

(CONSIGLIATA)

LUMEN	CCT	CODICE	€
910 lm	3000 K	119571	6
FINITURA		CODICE	€
Bianco		009087	78

1,920 Kg
0,0630 m³
E27 max 1 x 60W

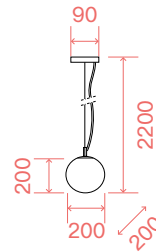

(CONSIGLIATA)

LUMEN	CCT	CODICE	€
910 lm	3000 K	119571	6
FINITURA		CODICE	€
Bianco		009148	52

1,130 Kg
0,0272 m³
E27 max 1 x 60W

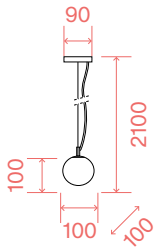

(CONSIGLIATA)

LUMEN	CCT	CODICE	€
510 lm	3000 K	305486	6
FINITURA		CODICE	€
Bianco		310800	50

0,041 Kg
0,0027 m³
G9 max 1 x 4W



Lampadine LED G9 4W 3000 K
Cod. 209043

MAPA BIANCO

DA PARETE/SOFFITTO  IP20

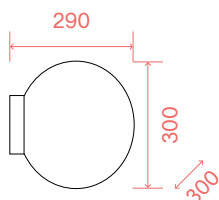

(CONSIGLIATA)

LUMEN	CCT	CODICE	€
430 lm	3000 K	101279	2,60
FINITURA		CODICE	€
Bianco		059822	88

1,660 Kg
0,0647 m³
E27 max 1 x 60W

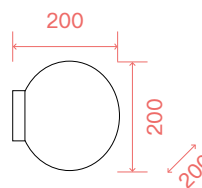

(CONSIGLIATA)

LUMEN	CCT	CODICE	€
430 lm	3000 K	101279	2,60
FINITURA		CODICE	€
Bianco		059815	50

0,900 Kg
0,0259 m³
E27 max 1 x 60W

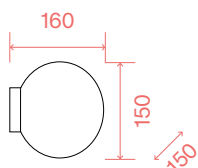

(CONSIGLIATA)

LUMEN	CCT	CODICE	€
510 lm	3000 K	305486	6
FINITURA		CODICE	€
Bianco		059808	44

0,380 Kg
0,0115 m³
G9 max 1 x 15W

 Lampadine LED G9 4W 3000 K
Cod. 209043

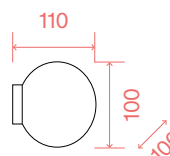

(CONSIGLIATA)

LUMEN	CCT	CODICE	€
510 lm	3000 K	305486	6
FINITURA		CODICE	€
Bianco		310787	35

0,230 Kg
0,0025 m³
G9 max 1 x 4W

 Lampadine LED G9 4W 3000 K
Cod. 209043

DA SOFFITTO  IP20

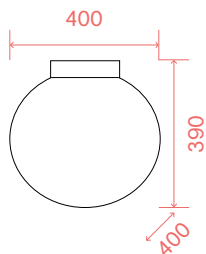

(CONSIGLIATA)

LUMEN	CCT	CODICE	€
910 lm	3000 K	119571	6
FINITURA		CODICE	€
Bianco		059839	188

2,590 Kg
0,1290 m³
E27 max 1 x 60W

MAPA BIANCO

DA TAVOLO



IP20



FOTO p. 204

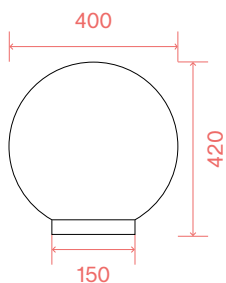

(CONSIGLIATA)

LUMEN	CCT	CODICE	€
910 lm	3000 K	119571	6

FINITURA	CODICE	€
Bianco	000206	165



3,520 Kg
0,1354 m³
E27 max 1 x 60W

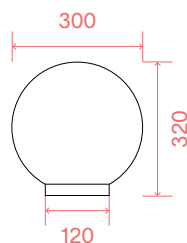

(CONSIGLIATA)

LUMEN	CCT	CODICE	€
910 lm	3000 K	119571	6

FINITURA	CODICE	€
Bianco	009131	85



1,880 Kg
0,0515 m³
E27 max 1 x 60W

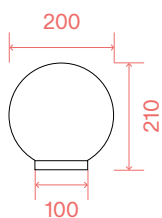

(CONSIGLIATA)

LUMEN	CCT	CODICE	€
910 lm	3000 K	119571	6

FINITURA	CODICE	€
Bianco	009155	50



1,050 Kg
0,0214 m³
E27 max 1 x 60W

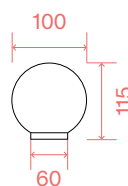

(CONSIGLIATA)

LUMEN	CCT	CODICE	€
510 lm	3000 K	305486	6

FINITURA	CODICE	€
Bianco	310817	45



Lampadine LED G9 4W 3000 K
Cod. 209043



0,280 Kg
0,0026 m³
G9 max 1 x 4W

MINT

SOSPENSIONE



IP20



FOTO p. 58

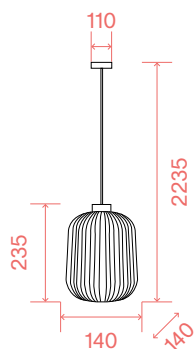

(CONSIGLIATA)

LUMEN	CCT	CODICE	€
910 lm	3000 K	119571	6

FINITURA	CODICE	€
Fumè	237442	105
Verde	248554	105

1,350 Kg
0,0147 m³
E27 max 1 x 60W

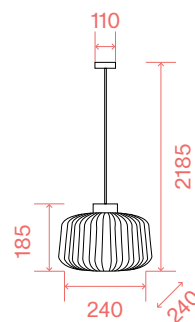

(CONSIGLIATA)

LUMEN	CCT	CODICE	€
910 lm	3000 K	119571	6

FINITURA	CODICE	€
Fumè	237398	127
Verde	237428	127

1,560 Kg
0,0532 m³
E27 max 1 x 60W

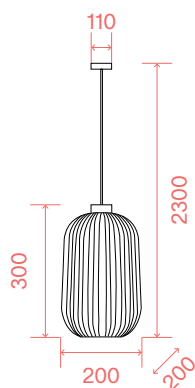

(CONSIGLIATA)

LUMEN	CCT	CODICE	€
910 lm	3000 K	119571	6

FINITURA	CODICE	€
Fumè	237510	138
Verde	237497	138

1,80 Kg
0,0269 m³
E27 max 1 x 60W

MIX UP

SOSPENSIONE



IP20



FOTO p. 62

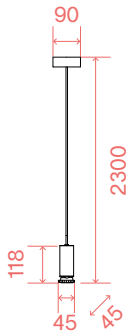

(CONSIGLIATA)

LUMEN	CCT	CODICE	€
900 lm	3000 K	123899	6

FINITURA	CODICE	€
Bianco	288406	55
Nero	288390	55

0,460 Kg
0,0018 m³
E27 max 1 x 60W

DA SOFFITTO



IP20

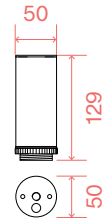

(CONSIGLIATA)

LUMEN	CCT	CODICE	€
900 lm	3000 K	123899	6

FINITURA	CODICE	€
Bianco	292847	35
Nero	292830	35

0,270 Kg
0,0005 m³
E27 max 1 x 60W

DA TERRA



IP20

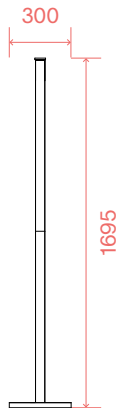

(CONSIGLIATA)

LUMEN	CCT	CODICE	€
900 lm	3000 K	123899	6

FINITURA	CODICE	€
Bianco	328164	200
Nero	328171	200



8,500 Kg
0,0326 m³
E27 max 1 x 42W

MIX UP

OPZIONI PARALUMI

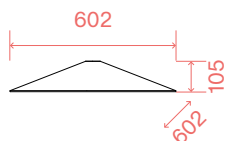

FINITURA	CODICE	€
Bianco	288437	85
Nero	288420	85

2,000 Kg
0,0676 m³

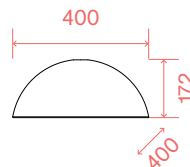

FINITURA	CODICE	€
Bianco	307404	55
Nero	288475	55

1,100 Kg
0,0446 m³

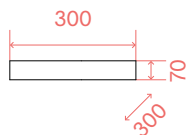

FINITURA	CODICE	€
Bianco	307411	40
Nero	288444	40

0,800 Kg
0,0147 m³

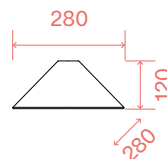

FINITURA	CODICE	€
Bianco	307428	35
Nero	288451	35

0,500 Kg
0,0174 m³

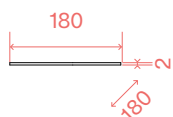

FINITURA	CODICE	€
Bianco	307435	20
Nero	288482	20

0,340 Kg
0,0008 m³

MOBY

SOSPENSIONE



IP20



FOTO p. 74

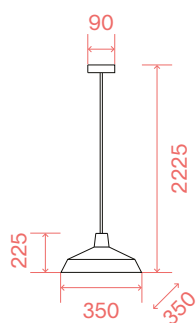

(CONSIGLIATA)

LUMEN	CCT	CODICE	€
950 lm	3000 K	101330	7,50

FINITURA	CODICE	€
Bianco	102047	127
Nero	093659	127
Rame	093697	127

1,200 Kg
0,0356 m³
E27 max 1 x 42W

NEMO

SOSPENSIONE



IP20



FOTO p. 80

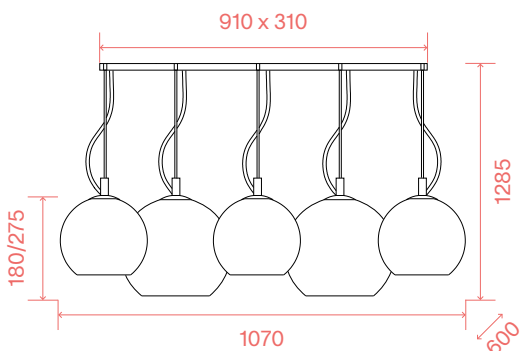

8,700 Kg
0,2424 m³
E27 max 5 x 60W

(CONSIGLIATA)

LUMEN	CCT	CODICE	€
910 lm	3000 K	119571	6

FINITURA	CODICE	€
Cromo Sfum.	138305	650

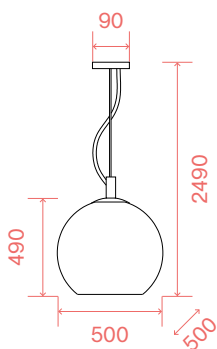

(CONSIGLIATA)

LUMEN	CCT	CODICE	€
1050 lm	3000 K	101347	8

FINITURA	CODICE	€
Fumè	094137	450

4,000 Kg
0,2220 m³
E27 max 1 x 60W

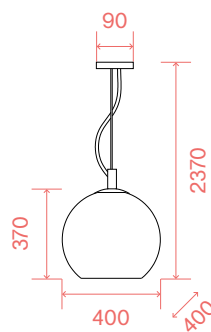

(CONSIGLIATA)

LUMEN	CCT	CODICE	€
1050 lm	3000 K	101347	8

FINITURA	CODICE	€
Trasparente	052816	250
Cromo sfum.	250359	250
Fumè	094229	250
Cromo	250342	250
Rame	111919	250

2,700 Kg
0,1227 m³
E27 max 1 x 60W

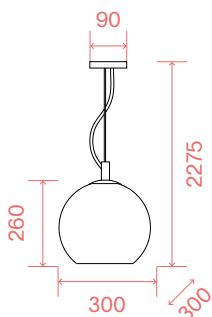

(CONSIGLIATA)

LUMEN	CCT	CODICE	€
1050 lm	3000 K	101323	7

FINITURA	CODICE	€
Trasparente	052809	165
Cromo sfum.	149592	165
Fumè	094236	165
Cromo	250335	165
Rame	111902	165

2,050 Kg
0,0664 m³
E27 max 1 x 60W

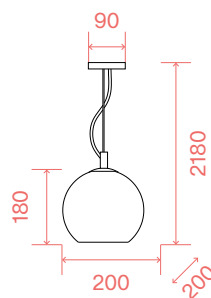

(CONSIGLIATA)

LUMEN	CCT	CODICE	€
1050 lm	3000 K	101323	7

FINITURA	CODICE	€
Cromo sfum.	149585	80
Fumè	250311	80
Cromo	250304	80
Rame	250328	80

1,300 Kg
0,0241 m³
E27 max 1 x 60W

ONION

SOSPENSIONE



IP20



FOTO p. 86

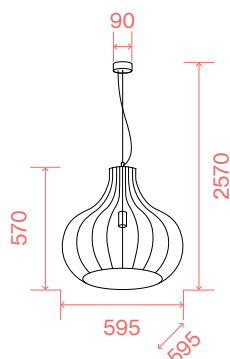

(CONSIGLIATA)

LUMEN	CCT	CODICE	€
480 lm	2200 K	151724	8

FINITURA	CODICE	€
Coffee	205311	400

5,050 Kg
0,2383 m³
E27 max 1 x 60W

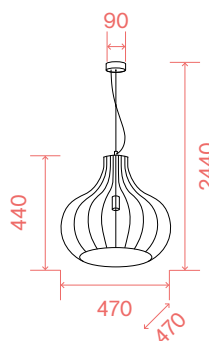

(CONSIGLIATA)

LUMEN	CCT	CODICE	€
480 lm	2200 K	151724	8

FINITURA	CODICE	€
Coffee	205304	270

3,520 Kg
0,1325 m³
E27 max 1 x 60W

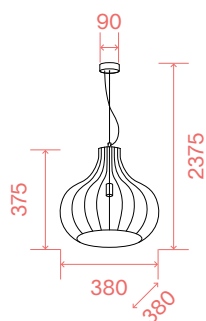

(CONSIGLIATA)

LUMEN	CCT	CODICE	€
500 lm	2200 K	151717	8

FINITURA	CODICE	€
Coffee	205298	180

2,380 Kg
0,0705 m³
E27 max 1 x 60W

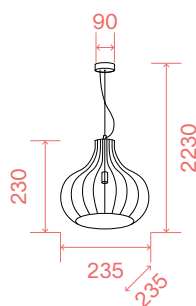

(CONSIGLIATA)

LUMEN	CCT	CODICE	€
500 lm	2200 K	151717	8

FINITURA	CODICE	€
Coffee	205281	95

1,260 Kg
0,0169 m³
E27 max 1 x 60W

ORACLE SLIM

SOSPENSIONE



IP20 DURATA LED: 20.000 h

↑ FOTO p. 94

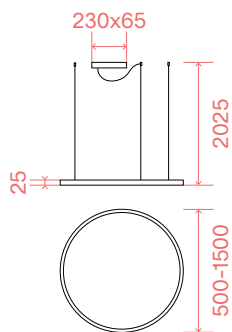

Lunghezza cavo
2500 mm

LED SMD (DRIVER INCLUSO)

DIMENSIONI	PESO	VOLUME	POTENZA	DRIVER	LUMEN	CCT	FINITURA	CODICE	€
ø 500	1,400 Kg	0,0376 m ³	32 W	On-Off	3150 lm	3000 K	Bianco	229461	200
ø 500	1,400 Kg	0,0376 m ³	32 W	On-Off	3150 lm	3000 K	Nero	229492	200
ø 500	1,400 Kg	0,0376 m ³	32 W	On-Off	3350 lm	4000 K	Bianco	269856	200
ø 500	1,400 Kg	0,0376 m ³	32 W	On-Off	3350 lm	4000 K	Nero	304380	200
ø 500	1,100 Kg	0,0272 m ³	29 W	DALI/Push	3000 lm	3000 K	Bianco	304373	250
ø 500	1,100 Kg	0,0272 m ³	29 W	DALI/Push	3000 lm	3000 K	Nero	304366	250
ø 700	1,660 Kg	0,0809 m ³	38 W	On-Off	4300 lm	3000 K	Bianco	229485	245
ø 700	1,660 Kg	0,0809 m ³	38 W	On-Off	4300 lm	3000 K	Nero	229515	245
ø 700	1,660 Kg	0,0809 m ³	38 W	On-Off	4500 lm	4000 K	Bianco	269863	245
ø 700	1,660 Kg	0,0809 m ³	38 W	On-Off	4500 lm	4000 K	Nero	304410	245
ø 700	1,200 Kg	0,0534 m ³	39 W	DALI/Push	4150 lm	3000 K	Bianco	304403	300
ø 700	1,200 Kg	0,0534 m ³	39 W	DALI/Push	4150 lm	3000 K	Nero	304397	300
ø 900	1,800 Kg	0,2212 m ³	55 W	On-Off	5400 lm	3000 K	Bianco	229478	300
ø 900	1,800 Kg	0,2212 m ³	55 W	On-Off	5400 lm	3000 K	Nero	229508	300
ø 900	1,800 Kg	0,2212 m ³	55 W	On-Off	5700 lm	4000 K	Bianco	269870	300
ø 900	1,800 Kg	0,2212 m ³	55 W	On-Off	5700 lm	4000 K	Nero	304441	300
ø 900	1,500 Kg	0,0857 m ³	43 W	DALI/Push	4600 lm	3000 K	Bianco	304434	360
ø 900	1,500 Kg	0,0857 m ³	43 W	DALI/Push	4600 lm	3000 K	Nero	304427	360
ø 1500	2,480 Kg	0,3072 m ³	89 W	On-Off	9000 lm	3000 K	Bianco	265957	490
ø 1500	2,480 Kg	0,3072 m ³	89 W	On-Off	9000 lm	3000 K	Nero	285061	490
ø 1500	2,480 Kg	0,3072 m ³	89 W	On-Off	9650 lm	4000 K	Bianco	285078	490
ø 1500	2,480 Kg	0,3072 m ³	89 W	On-Off	9650 lm	4000 K	Nero	304472	490
ø 1500	2,000 Kg	0,3072 m ³	76 W	DALI/Push	7050 lm	3000 K	Bianco	304465	600
ø 1500	2,000 Kg	0,3072 m ³	76 W	DALI/Push	7050 lm	3000 K	Nero	304458	600

ORACLE SLIM

SOSPENSIONE

 IP20 DURATA LED: 20.000 h

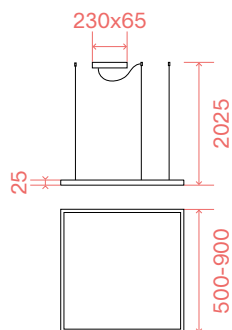

LED SMD (DRIVER ON/OFF INCLUSO)

DIMENSIONI	PESO	VOLUME	POTENZA	DRIVER	LUMEN	CCT	FINITURA	CODICE	€
500 x 500	1,730 Kg	0,0422 m ³	33 W	On-Off	3300 lm	3000 K	Bianco	259154	210
500 x 500	1,730 Kg	0,0422 m ³	33 W	On-Off	3300 lm	3000 K	Nero	259161	210
700 x 700	2,000 Kg	0,0819 m ³	41 W	On-Off	4350 lm	3000 K	Bianco	259178	255
700 x 700	2,000 Kg	0,0819 m ³	41 W	On-Off	4350 lm	3000 K	Nero	259185	255
900 x 900	2,100 Kg	0,1317 m ³	53 W	On-Off	5250 lm	3000 K	Bianco	259192	310
900 x 900	2,100 Kg	0,1317 m ³	53 W	On-Off	5250 lm	3000 K	Nero	259208	310

Lunghezza cavo
2500 mm

DA SOFFITTO

 IP20 DURATA LED: 20.000 h

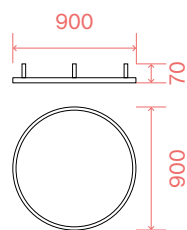

FINITURA	CODICE	€
Bianco	266015	295
Nero	266022	295

 Sorgente luminosa LED
3000 K, 20.000 h di durata.

1,700 Kg
0,1345 m³
LED 55W / 5300 lm

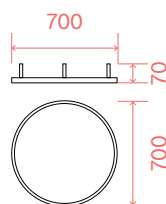

FINITURA	CODICE	€
Bianco	265995	240
Nero	266008	240

 Sorgente luminosa LED
3000 K, 20.000 h di durata.

1,430 Kg
0,0852 m³
LED 38W / 4300 lm

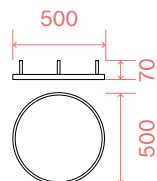

FINITURA	CODICE	€
Bianco	265971	195
Nero	265988	195

 Sorgente luminosa LED
3000 K, 20.000 h di durata.

1,240 Kg
0,0455 m³
LED 32W / 3150 lm

SOSPENSIONE



IP20



FOTO p. 102

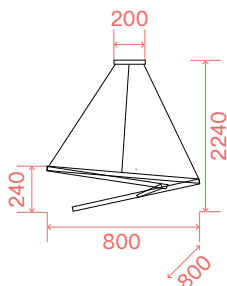

1,900 Kg
0,0607 m³
LED 55W / 6100 lm

ON-OFF

FINITURA	CODICE	€
Bianco	253664	390
Nero	269450	390
Ottone	269467	390

DALI/PUSH

FINITURA	CODICE	€
Bianco	304571	500
Nero	304588	500
Ottone	304595	500



Sorgente luminosa LED
3000 K, 30.000 h di durata.

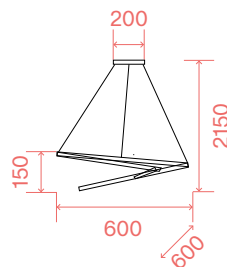

1,500 Kg
0,0354 m³
LED 48W / 5300 lm

ON-OFF

FINITURA	CODICE	€
Bianco	253671	325
Nero	269436	325
Ottone	269443	325

DALI/PUSH

FINITURA	CODICE	€
Bianco	304540	415
Nero	304557	415
Ottone	304564	415



Sorgente luminosa LED
3000 K, 30.000 h di durata.

DA SOFFITTO



IP20

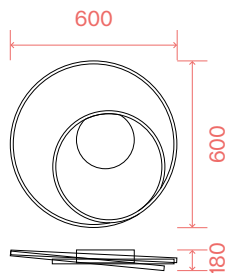

1,500 Kg
0,0354 m³
LED 48W / 5200 lm

ON-OFF

FINITURA	CODICE	€
Bianco	253688	320
Nero	269412	320
Ottone	269429	320

DALI/PUSH

FINITURA	CODICE	€
Bianco	304519	395
Nero	304526	395
Ottone	304533	395



Sorgente luminosa LED
3000 K, 30.000 h di durata.

OZ

DA PARETE

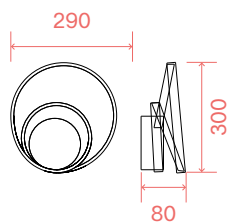

ON-OFF

FINITURA	CODICE	€
Bianco	253695	190
Nero	269399	190
Ottone	269405	190

DALI/PUSH

FINITURA	CODICE	€
Bianco	304489	255
Nero	304496	255
Ottone	304502	255

0,800 Kg
0,0087 m³
LED 28W / 2500 lm

Sorgente luminosa LED
3000 K, 30.000 h di durata.

DA TAVOLO



↑ FOTO p. 210

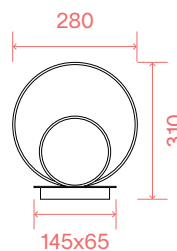

ON-OFF

FINITURA	CODICE	€
Bianco	269474	190
Nero	269481	190
Ottone	269498	190

0,890 Kg
0,0096 m³
LED 23W / 2300 lm

Sorgente luminosa LED
3000 K, 30.000 h di durata.



PERLAGE

SOSPENSIONE

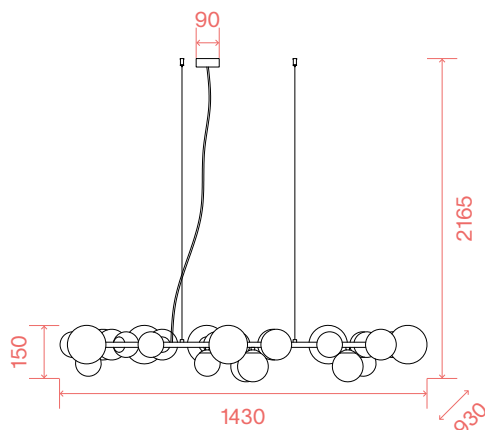

(CONSIGLIATA)

LUMEN	CCT	CODICE	€
510 lm	3000 K	305486	6

FINITURA	CODICE	€
Bianco	296746	1400
Fumè	296753	1400
Ambra	322780	1400

Lampadine LED G9 4W 3000 K
includ. Cod. 209043

8,920 Kg
0,2722 m³
G9 max 30 x 15W

PERLAGE

SOSPENSIONE



IP20



FOTO p. 108

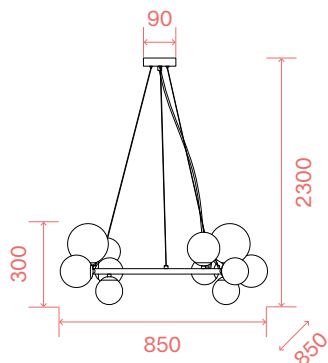

3,910 Kg
0,0924 m³
G9 max 14 x 15W

(CONSIGLIATA)

LUMEN	CCT	CODICE	€
510 lm	3000 K	305486	6

FINITURA	CODICE	€
Bianco	283814	620
Fumè	271385	620
Ambra	322797	620



Lampadine LED G9 4W 3000 K
includ. Cod. 209043

SOSPENSIONE



IP20

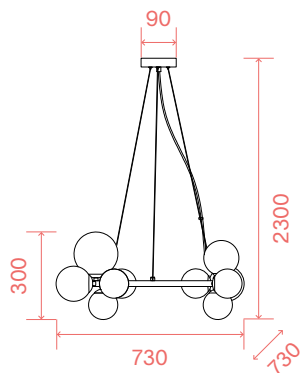

3,100 Kg
0,0736 m³
G9 max 11 x 15W

(CONSIGLIATA)

LUMEN	CCT	CODICE	€
510 lm	3000 K	305486	6

FINITURA	CODICE	€
Bianco	283807	530
Fumè	271392	530
Ambra	322773	530



Lampadine LED G9 4W 3000 K
includ. Cod. 209043

PERLAGE

SOSPENSIONE



IP20

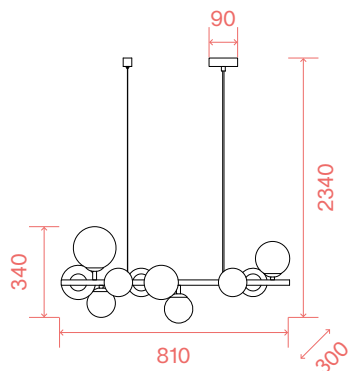

2,200 Kg
0,0617 m³
G9 max 10 x 15W

(CONSIGLIATA)

LUMEN	CCT	CODICE	€
510 lm	3000 K	305486	6

FINITURA	CODICE	€
Bianco	283791	390
Fumè	271408	390
Ambra	322766	390

Lampadine LED G9 4W 3000 K
includ. Cod. 209043

SOSPENSIONE



IP20

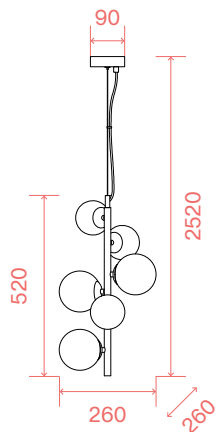

1,300 Kg
0,0317 m³
G9 max 6 x 15W

(CONSIGLIATA)

LUMEN	CCT	CODICE	€
510 lm	3000 K	305486	6

FINITURA	CODICE	€
Bianco	283821	260
Fumè	271422	260
Ambra	317793	260

Lampadine LED G9 4W 3000 K
includ. Cod. 209043

PERLAGE

DA SOFFITTO



IP20

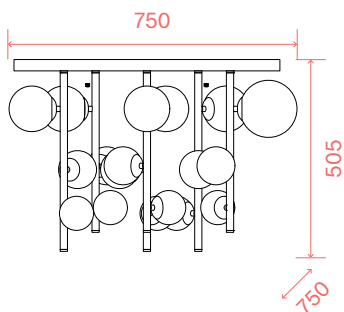

7,520 Kg
0,1314 m³
G9 max 18 x 15W

(CONSIGLIATA)

LUMEN	CCT	CODICE	€
510 lm	3000 K	305486	6

FINITURA	CODICE	€
Bianco	328393	740
Fumè	328386	740
Ambra	328379	740



Lampadine LED G9 4W 3000 K
includ. Cod. 209043

DA SOFFITTO



IP20

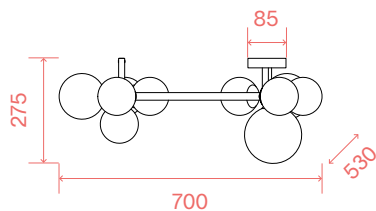

2,780 Kg
0,0605 m³
G9 max 10 x 15W

(CONSIGLIATA)

LUMEN	CCT	CODICE	€
510 lm	3000 K	305486	6

FINITURA	CODICE	€
Bianco	327815	450
Fumè	309286	450
Ambra	327808	450



Lampadine LED G9 4W 3000 K
includ. Cod. 209043

PERLAGE

DA SOFFITTO



IP20

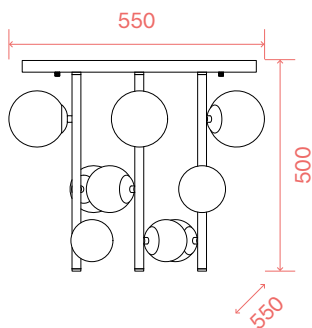

3,870 Kg
0,0622 m³
G9 max 9 x 15W

(CONSIGLIATA)

LUMEN	CCT	CODICE	€
510 lm	3000 K	305486	6

FINITURA	CODICE	€
Bianco	328423	380
Fumè	328416	380
Ambra	328409	380

Lampadine LED G9 4W 3000 K
includ. Cod. 209043

DA SOFFITTO



IP20

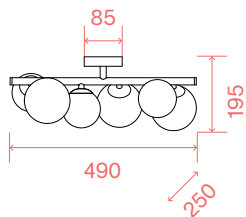

1,550 Kg
0,0385 m³
G9 max 6 x 15W

(CONSIGLIATA)

LUMEN	CCT	CODICE	€
510 lm	3000 K	305486	6

FINITURA	CODICE	€
Bianco	309279	230
Fumè	309262	230
Ambra	327822	230

Lampadine LED G9 4W 3000 K
includ. Cod. 209043

PERLAGE

DA PARETE

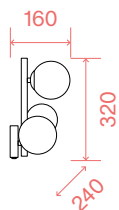

0,800 Kg
0,0173 m³
G9 max 3 x 15W

(CONSIGLIATA)

LUMEN	CCT	CODICE	€
510 lm	3000 K	305486	6

FINITURA	CODICE	€
Bianco	283784	150
Fumè	271439	150
Ambra	322742	150

Lampadine LED G9 4W 3000 K include. Cod. 209043

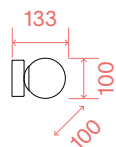

0,400 Kg
0,0062 m³
G9 max 1 x 15W

(CONSIGLIATA)

LUMEN	CCT	CODICE	€
510 lm	3000 K	305486	6

FINITURA	CODICE	€
Bianco	292410	65
Fumè	292403	65
Ambra	317809	65

Lampadine LED G9 4W 3000 K include. Cod. 209043

DA TAVOLO

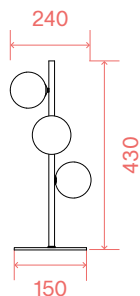

2,000 Kg
0,0227 m³
G9 max 3 x 15W

(CONSIGLIATA)

LUMEN	CCT	CODICE	€
510 lm	3000 K	305486	6

FINITURA	CODICE	€
Bianco	292472	175
Fumè	292465	175
Ambra	322759	175

Lampadine LED G9 4W 3000 K include. Cod. 209043

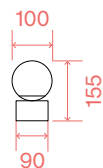

0,600 Kg
0,0062 m³
G9 max 1 x 15W

(CONSIGLIATA)

LUMEN	CCT	CODICE	€
510 lm	3000 K	305486	6

FINITURA	CODICE	€
Bianco	292458	75
Fumè	292441	75
Ambra	317823	75

Lampadine LED G9 4W 3000 K include. Cod. 209043



PERLAGE

DA TERRA



IP20



FOTO p. 270

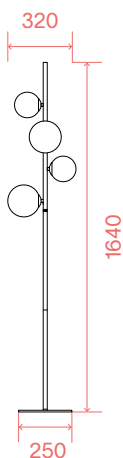

(CONSIGLIATA)

LUMEN	CCT	CODICE	€
510 lm	3000 K	305486	6

FINITURA	CODICE	€
Bianco	277967	285
Fumè	306988	285
Ambra	317816	285

 Lampadine LED G9 4W 3000 K
includ. Cod. 209043



4,800 Kg
0,0612 m³
G9 max 4 x 15W

PIANO

DA PARETE



IP20



FOTO p. 182

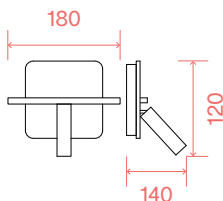

FINITURA	CODICE	€
Bianco	287317	165
Nero	287300	165

 Sorgente luminosa LED
3000 K, 20.000 h di durata.



0,800 Kg
0,0047 m³
LED 11,5W / 1200 lm

PIVOT

DA TAVOLO



IP20



FOTO p. 218

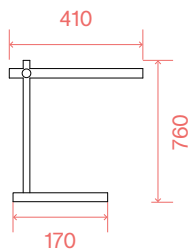

0,700 Kg
0,0135 m³
LED 7,5W / 700 lm

FINITURA	CODICE	€
Bianco	289168	75
Nero	289151	75



Sorgente luminosa LED.
CCT regolabile: 3000, 4000,
6000 K. 25.000 h di durata.



SET UP

SOSPENSIONE



IP20



0,350 Kg
0,0019 m³
E27 max 1 x 60W

(CONSIGLIATA)

LUMEN	CCT	CODICE	€
900 lm	3000 K	123899	6

FINITURA	CODICE	€
Bianco	260013	29
Nickel	260044	29
Nero	260020	29
Ottone	260051	29

DA SOFFITTO



IP20

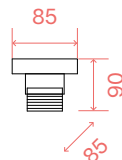

0,300 Kg
0,0010 m³
E27 max 1 x 60W

(CONSIGLIATA)

LUMEN	CCT	CODICE	€
900 lm	3000 K	123899	6

FINITURA	CODICE	€
Bianco	277288	35

SET UP

DA PARETE



IP20



FOTO p. 186

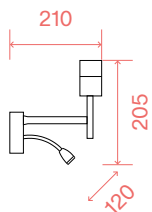

0,900 Kg
0,0063 m³
E27 max 1 x 60W +
LED 3W / 200 lm

(CONSIGLIATA)

LUMEN	CCT	CODICE	€
900 lm	3000 K	123899	6

FINITURA	CODICE	€
Bianco	259819	115
Nickel	259833	115
Nero	259826	115
Ottone	259857	115

Sorgente luminosa LED 3000 K
20.000 h di durata.

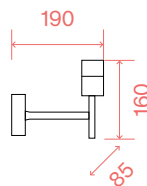

0,370 Kg
0,0032 m³
E27 max 1 x 60W

(CONSIGLIATA)

LUMEN	CCT	CODICE	€
900 lm	3000 K	123899	6

FINITURA	CODICE	€
Bianco	259765	55
Nickel	259796	55
Nero	259772	55
Ottone	259802	55

SET UP

DA TAVOLO



IP20



FOTO p. 224

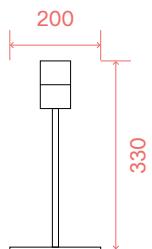

1,130 Kg
0,0055 m³
E27 max 1 x 60W

(CONSIGLIATA)

LUMEN	CCT	CODICE	€
900 lm	3000 K	123899	6

FINITURA	CODICE	€
Bianco	259918	78
Nickel	259949	78
Nero	259925	78
Ottone	259956	78

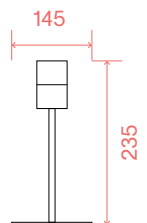

0,680 Kg
0,0061 m³
E27 max 1 x 60W

(CONSIGLIATA)

LUMEN	CCT	CODICE	€
900 lm	3000 K	123899	6

FINITURA	CODICE	€
Bianco	259864	61
Nickel	259895	61
Nero	259871	61
Ottone	259901	61



SET UP

DA TERRA



IP20



FOTO p. 276

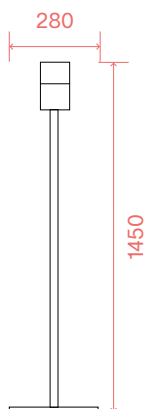

(CONSIGLIATA)

LUMEN	CCT	CODICE	€
900 lm	3000 K	123899	6

FINITURA	CODICE	€
Bianco	259963	145
Nickel	259994	145
Nero	259970	145
Ottone	260006	145



2,640 Kg
0,0251 m³
E27 max 1 x 60W

SET UP

OPZIONI PARALUMI

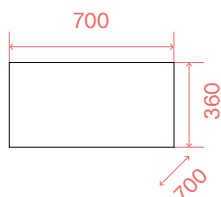

(SOLO PER VERS. SOSPENSIONE, DA SOFFITTO)

FINITURA	CODICE	€
Bianco	260471	116
Tortora	304632	116
Nero	270029	116
Beige	260488	116

1,260 Kg
0,2131 m³

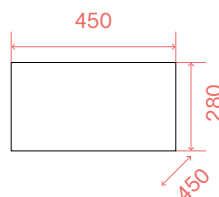

(SOLO PER VERS. SOSPENSIONE, DA SOFFITTO, DA TERRA)

FINITURA	CODICE	€
Bianco	260457	85
Tortora	304625	85
Nero	270012	85
Beige	260464	85

0,470 Kg
0,0221 m³

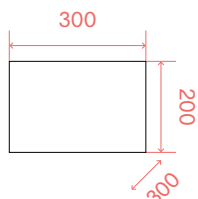

(SOLO PER VERS. DA SOFFITTO, DA PARETE, DA TAVOLO)

FINITURA	CODICE	€
Bianco	260433	55
Tortora	304618	55
Nero	270005	55
Beige	260440	55

0,230 Kg
0,0238 m³

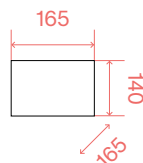

(SOLO PER VERS. DA PARETE, DA TAVOLO)

FINITURA	CODICE	€
Bianco	260327	28
Tortora	304601	28
Nero	269986	28
Beige	260334	28

0,012 Kg
0,0180 m³

SET UP

OPZIONI PARALUMI

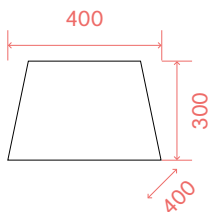

0,460 Kg
0,0709 m³

(SOLO PER VERS. DA TERRA)

FINITURA	CODICE	€
Bianco	260136	65
Tortora	304120	65
Nero	260235	65
Beige	260242	65

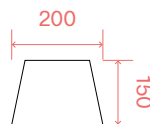

0,130 Kg
0,0180 m³

(SOLO PER VERS. DA PARETE,
DA TAVOLO)

FINITURA	CODICE	€
Bianco	260068	29
Tortora	304113	29
Nero	260075	29
Beige	260082	29

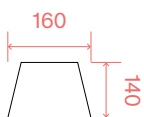

0,110 Kg
0,0180 m³

(SOLO PER VERS. DA PARETE,
DA TAVOLO)

FINITURA	CODICE	€
Bianco	260341	25
Tortora	293004	25
Nero	270036	25
Beige	260358	25

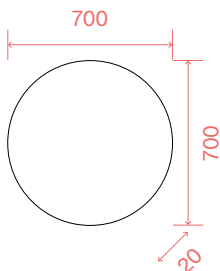

0,700 Kg
0,0259 m³

(SOLO PER VERS. SOSPENSIONE,
DA SOFFITTO)

FINITURA	CODICE	€
Trasparen.	270050	50

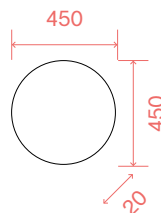

0,280 Kg
0,0108 m³

(SOLO PER VERS. SOSPENSIONE,
DA SOFFITTO)

FINITURA	CODICE	€
Trasparen.	270043	30

SPIKE

DA SOFFITTO



IP20



FOTO p. 146

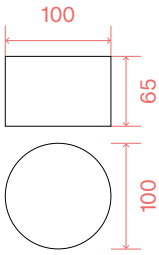

0,240 Kg
0,0017 m³
GX53 max 1 x 15W

(CONSIGLIATA)

LUMEN	CCT	CODICE	€
910 lm	3000 K	123936	5,50

FINITURA	CODICE	€
Bianco	277417	80
Cromo	310886	80
Nickel	314303	80
Nero	278704	80
Ottone	285238	80
Rame	310893	80

Lampadine LED GX53 9W
3000 K incluse. Cod. 123936

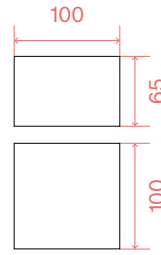

0,220 Kg
0,0014 m³
GX53 max 1 x 15W

(CONSIGLIATA)

LUMEN	CCT	CODICE	€
910 lm	3000 K	123936	5,50

FINITURA	CODICE	€
Bianco	317489	85
Cromo	328799	85
Nickel	328805	85
Nero	317496	85
Ottone	317502	85
Rame	328812	85

Lampadine LED GX53 9W
3000 K incluse. Cod. 123936

ULTRATHIN

SOSPENSIONE



IP20



FOTO p. 114

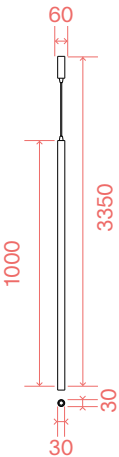

0,670 Kg
0,0036 m³
LED 11,5W / 1150 lm / 51°

ON-OFF

FINITURA	CODICE	€
Bianco	142906	130
Cromo	164878	130
Nero	142913	130

DALI/PUSH

FINITURA	CODICE	€
Nero	321783	185

Sorgente luminosa LED
3000 K, 20.000 h di durata.

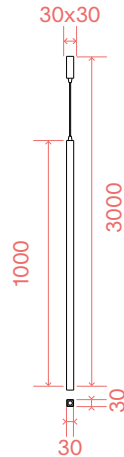

0,860 Kg
0,0036 m³
LED 11,5W / 1150 lm / 51°

ON-OFF

FINITURA	CODICE	€
Bianco	194172	190
Nero	194196	190

Sorgente luminosa LED
3000 K, 20.000 h di durata.

ULTRATHIN

SOSPENSIONE



IP20

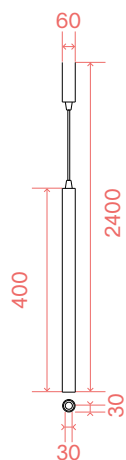

ON-OFF

FINITURA	CODICE	€
Bianco	156682	98
Cromo	187662	98
Nero	156699	98

DALI/PUSH

FINITURA	CODICE	€
Nero	321813	160

Sorgente luminosa LED
3000 K, 20.000 h di durata.

0,760 Kg
0,0037 m³
LED 11,5W / 1150 lm / 51°

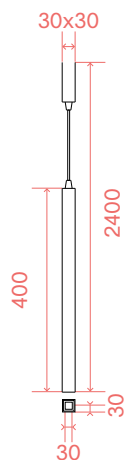

ON-OFF

FINITURA	CODICE	€
Bianco	194189	155
Nero	194202	155

Sorgente luminosa LED
3000 K, 20.000 h di durata.

0,450 Kg
0,0019 m³
LED 11,5W / 1150 lm / 51°

YOKO

SOSPENSIONE



IP20

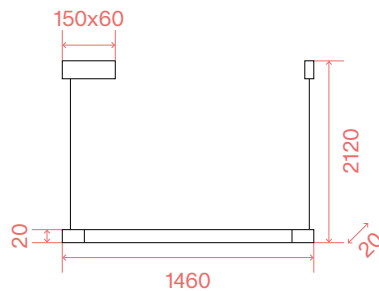

FINITURA	CODICE	€
Bianco	258898	130
Nero	258928	130

Sorgente luminosa LED
3000 K, 30.000 h di durata.

0,700 Kg
0,0383 m³
LED 16W / 1450 lm

YOKO

DA TAVOLO



IP20



FOTO p. 230

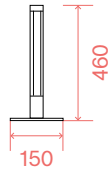

0,860 Kg
0,247 m³
LED 5W / 410 lm

FINITURA	CODICE	€
Bianco	258881	85
Nero	258911	85

Sorgente luminosa LED
3000 K, 30.000 h di durata.



DA TERRA



IP20



FOTO p. 280

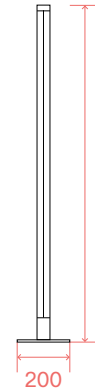

1,650 Kg
0,0534 m³
LED 16W / 1350 lm

FINITURA	CODICE	€
Bianco	258874	135
Nero	258904	135

Sorgente luminosa LED
3000 K, 30.000 h di durata.



ZIG ZAG

DA PARETE



IP20



FOTO p. 190

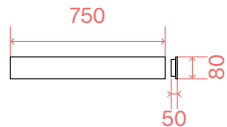

1,040 Kg
0,0047 m³
LED 30W
4100/4300 lm

FINITURA	CCT	CODICE	€
Bianco	3000 K	277219	135
Bianco	4000 K	277257	135
Cromo	3000 K	307183	135
Nero	3000 K	277226	135
Ottone	3000 K	287072	135
Rame	3000 K	307190	135

Sorgente luminosa LED
3000/4000 K, 50.000 h
di durata.

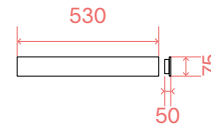

0,760 Kg
0,0034 m³
LED 23W
2900/3050 lm

FINITURA	CCT	CODICE	€
Bianco	3000 K	179308	103
Bianco	4000 K	277240	103
Cromo	3000 K	282152	103
Nero	3000 K	179322	103
Ottone	3000 K	282138	103
Rame	3000 K	282176	103

Sorgente luminosa LED
3000/4000 K, 50.000 h
di durata.

ZIG ZAG

DA PARETE

 IP20

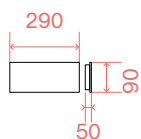

0,450 Kg
0,0020 m³
LED 12,5W
1450/1550 lm

FINITURA	CCT	CODICE	€
Bianco	3000 K	179292	90
Bianco	4000 K	277233	90
Cromo	3000 K	282145	90
Nero	3000 K	179315	90
Ottone	3000 K	282121	90
Rame	3000 K	282169	90

 Sorgente luminosa LED
3000/4000 K, 50.000 h
di durata.

BENTO

DA INCASSO



IP20 MacAdam: SDCM 3 UGR: <19 CRI: ≥90 DURATA LED: 50.000 h



↑ FOTO p. 352

	NECESSARIO	ANGOLO	FINITURA	CODICE	€
LENS	No	18°	Trasparen.	287942	4
LENS	No	45°	Trasparen.	279626	4
FILTER HONEYCOMB	No		Nero	279718	4
DIFFUSER	No		Nero	279725	3
SNOOT	No		Nero	279701	4
ANTI-GLARE RING	No		Bianco	288147	3
ANTI-GLARE RING	No		Nero	279695	3

LED COB CITIZEN (NECESSARIO - DRIVER TRIDONIC ON/OFF INCLUSO)

POTENZA	ANGOLO	LUMEN	CCT	FINITURA	CODICE	€
9 W	36°	730 lm	3000 K	Nero	279596	45

DIMMABLE DRIVER* (NON INCLUSO/OPTIONAL)

	POTENZA	OUTPUT	MISURE	CODICE	€
1-10V	12 W	250 mA	122 x 25 x 40 mm	287843	58
DALI / Push	20 W	250 mA	120 x 29 x 51 mm	287850	87

* Gli alimentatori dimmerabili devono essere ordinati contestualmente al prodotto e verranno già inclusi all'interno degli apparecchi in sostituzione degli alimentatori on-off.

LED COB CITIZEN (NECESSARIO - DRIVER TRIDONIC ON/OFF INCLUSO)

POTENZA	ANGOLO	LUMEN	CCT	FINITURA	CODICE	€
13 W	36°	1000 lm	3000 K	Nero	279602	50

DIMMABLE DRIVER (NON INCLUSO/OPTIONAL)

	POTENZA	OUTPUT	MISURE	CODICE	€
1-10V / Push	20 W	350 mA	108 x 22 x 52 mm	287867	75
DALI / Push	20 W	350 mA	120 x 29 x 51 mm	287874	80

* Gli alimentatori dimmerabili devono essere ordinati contestualmente al prodotto e verranno già inclusi all'interno degli apparecchi in sostituzione degli alimentatori on-off.

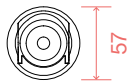
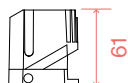

30° 355°

0,400 Kg
0,0030 m³

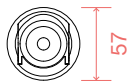
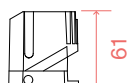

30° 355°

0,400 Kg
0,0030 m³

BENTO

FRAME AND REFLECTOR

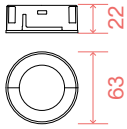

ROUND - REFLECTOR
(NECESSARIO)

FINITURA	CODICE	€
Bianco	279633	6
Nero	279640	6

0,020 Kg
0,0001 m³

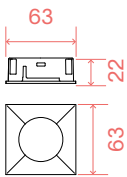

SQUARE - REFLECTOR
(NECESSARIO)

FINITURA	CODICE	€
Bianco	279671	8
Nero	279688	8

0,020 Kg
0,0001 m³

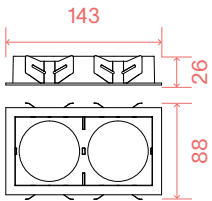

SQUARE - FRAME TWIN
(NECESSARIO)

FINITURA	CODICE	€
Bianco	287935	24
Nero	280233	24

134x71

0,110 Kg
0,0004 m³

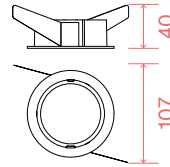

ROUND - FRAME SINGLE
(NECESSARIO)

FINITURA	CODICE	€
Bianco	287898	12
Nero	287881	12

68

0,060 Kg
0,0007 m³

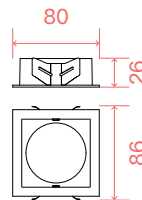

SQUARE - FRAME SINGLE
(NECESSARIO)

FINITURA	CODICE	€
Bianco	287911	14
Nero	287904	14

68x68

0,050 Kg
0,0002 m³

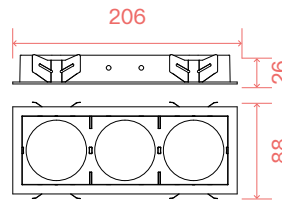

SQUARE - FRAME TRIPLE
(NECESSARIO)

FINITURA	CODICE	€
Bianco	287928	30
Nero	280240	30

197x71

0,300 Kg
0,0006 m³

DISPLAY ACCENT

PROIETTORI



IP20 MacAdam: SDCM 3 UGR: <16 CRI: ≥80 DURATA LED: 50.000 h



↑ FOTO p. 295

0,400 Kg
0,0064 m³



LED SMD SAMSUNG (DRIVER ON/OFF INCLUSO)

POTENZA	ANGOLO	LUMEN	CCT	FINITURA	CODICE	€
14 W	60°	1800 lm	3000 K	Bianco	283593	210
14 W	60°	1800 lm	3000 K	Nero	283609	210
14 W	60°	1900 lm	4000 K	Bianco	283616	210
14 W	60°	1900 lm	4000 K	Nero	283623	210

1,120 Kg
0,0112 m³



LED SMD SAMSUNG (DRIVER ON/OFF INCLUSO)

POTENZA	ANGOLO	LUMEN	CCT	FINITURA	CODICE	€
28 W	60°	3500 lm	3000 K	Bianco	283524	330
28 W	60°	3500 lm	3000 K	Nero	276267	330
28 W	60°	3700 lm	4000 K	Bianco	283531	330
28 W	60°	3700 lm	4000 K	Nero	283548	330

1,570 Kg
0,0173 m³



LED SMD SAMSUNG (DRIVER ON/OFF INCLUSO)

POTENZA	ANGOLO	LUMEN	CCT	FINITURA	CODICE	€
40 W	60°	5300 lm	3000 K	Bianco	283555	455
40 W	60°	5300 lm	3000 K	Nero	283562	455
40 W	60°	5600 lm	4000 K	Bianco	283579	455
40 W	60°	5600 lm	4000 K	Nero	283586	455

DISPLAY WIDE

PROIETTORI



IP20 MacAdam: SDCM 3 CRI: ≥80 DURATA LED: 50.000 h



↑ FOTO p. 288

0,420 Kg
0,0067 m³

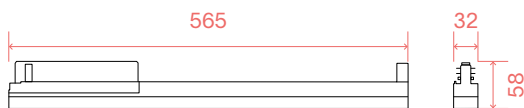

LED SMD SAMSUNG (DRIVER ON/OFF INCLUSO)

POTENZA	ANGOLO	LUMEN	CCT	FINITURA	CODICE	€
21 W	125°	2700 lm	3000 K	Bianco	283753	175
21 W	125°	2700 lm	3000 K	Nero	283760	175
21 W	125°	2850 lm	4000 K	Bianco	276274	175
21 W	125°	2850 lm	4000 K	Nero	283777	175

0,770 Kg
0,0124 m³

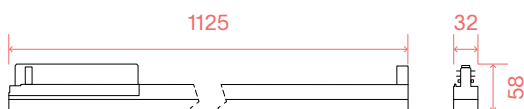

LED SMD SAMSUNG (DRIVER ON/OFF INCLUSO)

POTENZA	ANGOLO	LUMEN	CCT	FINITURA	CODICE	€
40 W	125°	5700 lm	3000 K	Bianco	283722	265
40 W	125°	5700 lm	3000 K	Nero	283050	265
40 W	125°	5850 lm	4000 K	Bianco	283739	265
40 W	125°	5850 lm	4000 K	Nero	283746	265

DISPLAY UGR

PROIETTORI



IP20 MacAdam: SDCM 3 UGR: <22 CRI: ≥80 DURATA LED: 50.000 h



↑ FOTO p. 290

0,400 Kg
0,0064 m³



LED SMD SAMSUNG (DRIVER ON/OFF INCLUSO)

POTENZA	ANGOLO	LUMEN	CCT	FINITURA	CODICE	€
14 W	70°	2000 lm	3000 K	Bianco	283685	185
14 W	70°	2000 lm	3000 K	Nero	283692	185
14 W	70°	2100 lm	4000 K	Bianco	283708	185
14 W	70°	2100 lm	4000 K	Nero	283715	185

1,120 Kg
0,0112 m³



LED SMD SAMSUNG (DRIVER ON/OFF INCLUSO)

POTENZA	ANGOLO	LUMEN	CCT	FINITURA	CODICE	€
27 W	70°	4000 lm	3000 K	Bianco	283647	290
27 W	70°	4000 lm	3000 K	Nero	283630	290
27 W	70°	4300 lm	4000 K	Bianco	276281	290
27 W	70°	4300 lm	4000 K	Nero	283258	290

1,570 Kg
0,0173 m³



LED SMD SAMSUNG (DRIVER ON/OFF INCLUSO)

POTENZA	ANGOLO	LUMEN	CCT	FINITURA	CODICE	€
40 W	70°	6050 lm	3000 K	Bianco	283654	410
40 W	70°	6050 lm	3000 K	Nero	283067	410
40 W	70°	6450 lm	4000 K	Bianco	283661	410
40 W	70°	6450 lm	4000 K	Nero	283678	410

EGO TRACK SINGLE

SISTEMI



IP20 MacAdam: SDCM 3 CRI: ≥90 DURATA LED: 50.000 h



↑ FOTO p. 298

LED SMD OSRAM

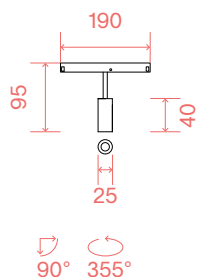

0,080 Kg
0,0041 m³

POTENZA	ANGOLO	CONTROLLO	LUMEN	CCT	FINITURA	CODICE	€
3 W	30°	On-Off	200 lm	3000 K	Bianco	282978	85
3 W	30°	On-Off	200 lm	3000 K	Nero	257617	85
3 W	30°	On-Off	200 lm	3000 K	Ottone	282039	85
3 W	30°	On-Off	220 lm	4000 K	Nero	321912	85
3 W	30°	1-10V	200 lm	3000 K	Bianco	303673	120
3 W	30°	1-10V	200 lm	3000 K	Nero	303666	120
3 W	30°	DALI	200 lm	3000 K	Bianco	286402	140
3 W	30°	DALI	200 lm	3000 K	Nero	286396	140
3 W	30°	DALI	220 lm	4000 K	Nero	317977	140

LED COB CITIZEN

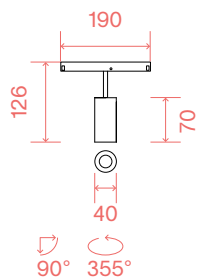

0,150 Kg
0,0041 m³

POTENZA	ANGOLO	CONTROLLO	LUMEN	CCT	FINITURA	CODICE	€
8 W	30°	On-Off	850 lm	3000 K	Bianco	282985	107
8 W	30°	On-Off	850 lm	3000 K	Nero	257631	107
8 W	30°	On-Off	850 lm	3000 K	Ottone	282046	107
8 W	30°	On-Off	900 lm	4000 K	Nero	317984	107
8 W	30°	1-10V	850 lm	3000 K	Bianco	303697	130
8 W	30°	1-10V	850 lm	3000 K	Nero	303680	130
8 W	30°	DALI	850 lm	3000 K	Bianco	286426	160
8 W	30°	DALI	850 lm	3000 K	Nero	286419	160
8 W	30°	DALI	900 lm	4000 K	Nero	321936	160

LED COB CITIZEN

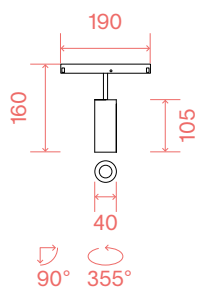

0,190 Kg
0,0041 m³

POTENZA	ANGOLO	CONTROLLO	LUMEN	CCT	FINITURA	CODICE	€
12 W	30°	On-Off	1200 lm	3000 K	Bianco	282992	115
12 W	30°	On-Off	1200 lm	3000 K	Nero	257655	115
12 W	30°	On-Off	1200 lm	3000 K	Ottone	282053	115
12 W	30°	On-Off	1250 lm	4000 K	Nero	321967	115
12 W	30°	1-10V	1200 lm	3000 K	Bianco	303710	135
12 W	30°	1-10V	1200 lm	3000 K	Nero	303703	135
12 W	30°	DALI	1200 lm	3000 K	Bianco	286440	165
12 W	30°	DALI	1200 lm	3000 K	Nero	286433	165
12 W	30°	DALI	1250 lm	4000 K	Nero	321943	165

FILTER HONEYCOMB

MODELLO	NECESSARIO	CODICE	€
Ego 3 W	No	260853	5
Ego 8 W	No	260860	5
Ego 12 W	No	260860	5

EGO TRACK SINGLE

SISTEMI



IP20 MacAdam: SDCM 3 CRI: ≥90 DURATA LED: 50.000 h



↑ FOTO p. 298

LED COB CITIZEN

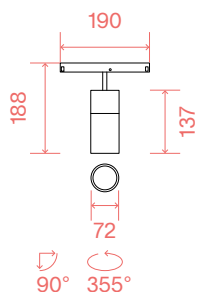

0,700 Kg
0,0035 m³

POTENZA	ANGOLO	CONTROLLO	LUMEN	CCT	FINITURA	CODICE	€
19 W	35°	On-Off	2200 lm	3000 K	Bianco	307558	175
19 W	35°	On-Off	2200 lm	3000 K	Nero	305608	175
19 W	35°	On-Off	2350 lm	4000 K	Nero	321998	175
19 W	35°	1-10V	2200 lm	3000 K	Bianco	307527	195
19 W	35°	1-10V	2200 lm	3000 K	Nero	307510	195
19 W	35°	DALI	2200 lm	3000 K	Bianco	307541	230
19 W	35°	DALI	2200 lm	3000 K	Nero	307534	230
19 W	35°	DALI	2350 lm	4000 K	Nero	321974	230

LED COB CITIZEN

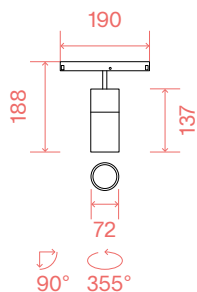

0,700 Kg
0,0035 m³

POTENZA	ANGOLO	CONTROLLO	LUMEN	CCT	FINITURA	CODICE	€
26 W	35°	On-Off	3050 lm	3000 K	Bianco	307602	180
26 W	35°	On-Off	3050 lm	3000 K	Nero	305615	180
26 W	35°	On-Off	3150 lm	4000 K	Nero	317991	180
26 W	35°	1-10V	3050 lm	3000 K	Bianco	307572	200
26 W	35°	1-10V	3050 lm	3000 K	Nero	307565	200
26 W	35°	DALI	3050 lm	3000 K	Bianco	307596	235
26 W	35°	DALI	3050 lm	3000 K	Nero	307589	235
26 W	35°	DALI	3150 lm	4000 K	Nero	322001	235

EGO TRACK DOUBLE

SISTEMI



IP20 MacAdam: SDCM 3 CRI: ≥90 DURATA LED: 50.000 h



LED SMD OSRAM

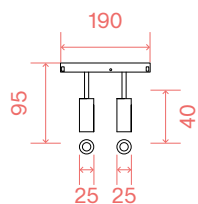

90° 355°

0,120 Kg
0,0041 m³

POTENZA	ANGOLO	CONTROLLO	LUMEN	CCT	FINITURA	CODICE	€
5 W	30°	On-Off	400 lm	3000 K	Bianco	282947	120
5 W	30°	On-Off	400 lm	3000 K	Nero	257624	120
5 W	30°	On-Off	400 lm	3000 K	Ottone	282008	120
5 W	30°	On-Off	430 lm	4000 K	Nero	321714	120
5 W	30°	1-10V	400 lm	3000 K	Bianco	303611	145
5 W	30°	1-10V	400 lm	3000 K	Nero	303604	145
5 W	30°	DALI	400 lm	3000 K	Bianco	286341	170
5 W	30°	DALI	400 lm	3000 K	Nero	286334	170
5 W	30°	DALI	430 lm	4000 K	Nero	321677	170

LED COB CITIZEN

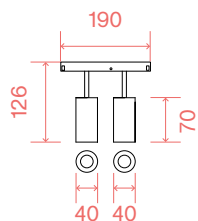

90° 355°

0,260 Kg
0,0041 m³

POTENZA	ANGOLO	CONTROLLO	LUMEN	CCT	FINITURA	CODICE	€
16 W	30°	On-Off	1500 lm	3000 K	Bianco	282954	160
16 W	30°	On-Off	1500 lm	3000 K	Nero	257648	160
16 W	30°	On-Off	1500 lm	3000 K	Ottone	282015	160
16 W	30°	On-Off	1550 lm	4000 K	Nero	321806	160
16 W	30°	1-10V	1500 lm	3000 K	Bianco	303635	190
16 W	30°	1-10V	1500 lm	3000 K	Nero	303628	190
16 W	30°	DALI	1500 lm	3000 K	Bianco	286365	210
16 W	30°	DALI	1500 lm	3000 K	Nero	286358	210
16 W	30°	DALI	1550 lm	4000 K	Nero	321721	210

LED COB CITIZEN

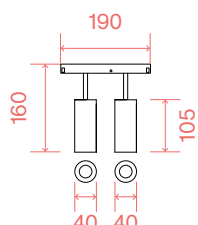

90° 355°

0,340 Kg
0,0041 m³

POTENZA	ANGOLO	CONTROLLO	LUMEN	CCT	FINITURA	CODICE	€
24 W	30°	On-Off	2400 lm	3000 K	Bianco	282961	170
24 W	30°	On-Off	2400 lm	3000 K	Nero	257662	170
24 W	30°	On-Off	2400 lm	3000 K	Ottone	282022	170
24 W	30°	On-Off	2500 lm	4000 K	Nero	321844	170
24 W	30°	1-10V	2400 lm	3000 K	Bianco	303659	195
24 W	30°	1-10V	2400 lm	3000 K	Nero	303642	195
24 W	30°	DALI	2400 lm	3000 K	Bianco	286389	220
24 W	30°	DALI	2400 lm	3000 K	Nero	286372	220
24 W	30°	DALI	2500 lm	4000 K	Nero	321899	220

FILTER HONEYCOMB

MODELLO	NECESSARIO	CODICE	€
Ego 5 W	No	260853	5
Ego 16 W	No	260860	5
Ego 24 W	No	260860	5

EGO TRACK BIG

SISTEMI



MacAdam: SDCM 3 UGR: <19 CRI: ≥90 DURATA LED: 50.000 h

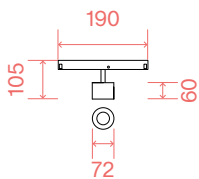

0,350 Kg
0,0035 m³

LED COB CITIZEN

POTENZA	ANGOLO	CONTROLLO	LUMEN	CCT	FINITURA	CODICE	€
10 W	38°	On-Off	1000 lm	3000 K	Bianco	327556	140
10 W	38°	On-Off	1000 lm	3000 K	Nero	300764	140

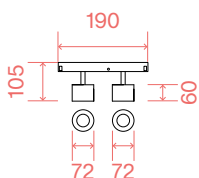

0,750 Kg
0,0026 m³

LED COB CITIZEN

POTENZA	ANGOLO	CONTROLLO	LUMEN	CCT	FINITURA	CODICE	€
20 W	38°	On-Off	2000 lm	3000 K	Bianco	327549	240
20 W	38°	On-Off	2000 lm	3000 K	Nero	316307	240

EGO TRACK FLAT

SISTEMI



MacAdam: SDCM 3 CRI: ≥90 DURATA LED: 50.000 h



↑ FOTO p. 306

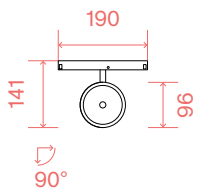

0,350 Kg
0,0060 m³

LED COB CITIZEN

POTENZA	ANGOLO	CONTROLLO	LUMEN	CCT	FINITURA	CODICE	€
9 W	36°	On-Off	1100 lm	3000 K	Bianco	300504	125
9 W	36°	On-Off	1100 lm	3000 K	Nero	290614	125
9 W	36°	On-Off	1100 lm	3000 K	Ottone	300511	125
9 W	36°	1-10V	1100 lm	3000 K	Bianco	303741	140
9 W	36°	1-10V	1100 lm	3000 K	Nero	303727	140
9 W	36°	1-10V	1100 lm	3000 K	Ottone	303734	140
9 W	36°	DALI	1100 lm	3000 K	Bianco	300535	175
9 W	36°	DALI	1100 lm	3000 K	Nero	300528	175
9 W	36°	DALI	1100 lm	3000 K	Ottone	300542	175

EGO ACCENT

SISTEMI



IP20 MacAdam: SDCM 3 UGR: <19 CRI: ≥90 DURATA LED: 50.000 h



↑ FOTO p. 313

0,140 Kg
0,0013 m³

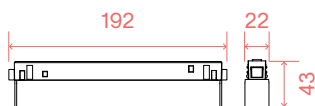

LED SMD OSRAM

POTENZA	ANGOLO	CONTROLLO	LUMEN	CCT	FINITURA	CODICE	€
7 W	35°	On-Off	700 lm	3000 K	Bianco	282633	115
7 W	35°	On-Off	700 lm	3000 K	Nero	257792	115
7 W	35°	On-Off	730 lm	4000 K	Nero	323596	115
7 W	35°	1-10V	700 lm	3000 K	Bianco	303505	155
7 W	35°	1-10V	700 lm	3000 K	Nero	303499	155
7 W	35°	DALI	700 lm	3000 K	Bianco	286068	170
7 W	35°	DALI	700 lm	3000 K	Nero	286051	170
7 W	35°	DALI	730 lm	4000 K	Nero	321790	170

0,210 Kg
0,0019 m³

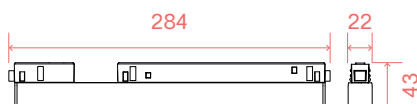

LED SMD OSRAM

POTENZA	ANGOLO	CONTROLLO	LUMEN	CCT	FINITURA	CODICE	€
13 W	35°	On-Off	1300 lm	3000 K	Bianco	282640	165
13 W	35°	On-Off	1300 lm	3000 K	Nero	257686	165
13 W	35°	On-Off	1350 lm	4000 K	Nero	317953	165
13 W	35°	1-10V	1300 lm	3000 K	Bianco	303529	190
13 W	35°	1-10V	1300 lm	3000 K	Nero	303512	190
13 W	35°	DALI	1300 lm	3000 K	Bianco	286082	230
13 W	35°	DALI	1300 lm	3000 K	Nero	286075	230
13 W	35°	DALI	1350 lm	4000 K	Nero	321820	230

EGO WIDE

SISTEMI



IP20

MacAdam: SDCM 3

CRI: ≥90

DURATA LED: 50.000 h



FOTO p. 310

0,200 Kg
0,0004 m³

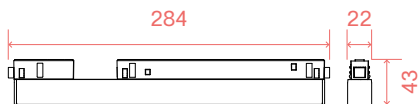

LED SMD SAMSUNG

POTENZA	ANGOLO	CONTROLLO	LUMEN	CCT	FINITURA	CODICE	€
7 W	110°	On-Off	850 lm	3000 K	Bianco	283029	85
7 W	110°	On-Off	850 lm	3000 K	Nero	257709	85
7 W	110°	On-Off	880 lm	4000 K	Nero	317960	85
7 W	110°	1-10V	850 lm	3000 K	Bianco	303796	130
7 W	110°	1-10V	850 lm	3000 K	Nero	303789	130
7 W	110°	DALI	850 lm	3000 K	Bianco	286501	145
7 W	110°	DALI	850 lm	3000 K	Nero	286495	145
7 W	110°	DALI	880 lm	4000 K	Nero	322025	145

0,340 Kg
0,0006 m³

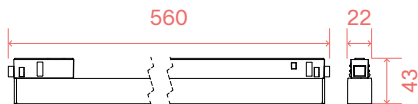

LED SMD SAMSUNG

POTENZA	ANGOLO	CONTROLLO	LUMEN	CCT	FINITURA	CODICE	€
13 W	110°	On-Off	1700 lm	3000 K	Bianco	283036	118
13 W	110°	On-Off	1700 lm	3000 K	Nero	257716	118
13 W	110°	On-Off	1750 lm	4000 K	Nero	322056	118
13 W	110°	1-10V	1700 lm	3000 K	Bianco	303819	165
13 W	110°	1-10V	1700 lm	3000 K	Nero	303802	165
13 W	110°	DALI	1700 lm	3000 K	Bianco	286525	170
13 W	110°	DALI	1700 lm	3000 K	Nero	286518	170
13 W	110°	DALI	1750 lm	4000 K	Nero	322032	170

EGO WIDE

SISTEMI



IP20 MacAdam: SDCM 3 CRI: ≥90 DURATA LED: 50.000 h



↑ FOTO p. 310

0,620 Kg
0,0013 m³

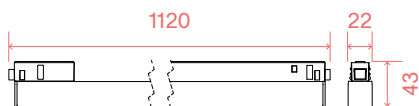

LED SMD SAMSUNG

POTENZA	ANGOLO	CONTROLLO	LUMEN	CCT	FINITURA	CODICE	€
26 W	110°	On-Off	3400 lm	3000 K	Bianco	283043	170
26 W	110°	On-Off	3400 lm	3000 K	Nero	257730	170
26 W	110°	On-Off	3500 lm	4000 K	Nero	322070	170
26 W	110°	1-10V	3400 lm	3000 K	Bianco	303833	200
26 W	110°	1-10V	3400 lm	3000 K	Nero	303826	200
26 W	110°	DALI	3400 lm	3000 K	Bianco	286549	215
26 W	110°	DALI	3400 lm	3000 K	Nero	286532	215
26 W	110°	DALI	3500 lm	4000 K	Nero	322063	215

EGO FLEXIBLE ACCENT

SISTEMI



IP20 MacAdam: SDCM 3 CRI: ≥90 UGR <19 DURATA LED: 50.000 h



0,470 Kg
0,0031 m³

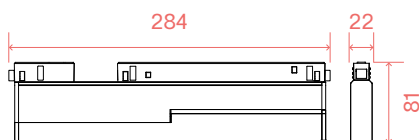

90°

LED SMD SAMSUNG

POTENZA	ANGOLO	CONTROLLO	LUMEN	CCT	FINITURA	CODICE	€
13 W	35°	On-Off	1300 lm	3000 K	Bianco	282718	200
13 W	35°	On-Off	1300 lm	3000 K	Nero	257846	200
13 W	35°	1-10V	1300 lm	3000 K	Bianco	303543	225
13 W	35°	1-10V	1300 lm	3000 K	Nero	303536	225
13 W	35°	DALI	1300 lm	3000 K	Bianco	286105	250
13 W	35°	DALI	1300 lm	3000 K	Nero	286099	250

EGO FLEXIBLE WIDE

SISTEMI



IP20 MacAdam: SDCM 3 CRI: ≥ 90 DURATA LED: 50.000 h



0,490 Kg
0,0032 m³

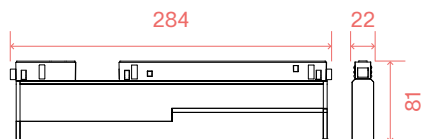

90°

LED SMD SAMSUNG

POTENZA	ANGOLO	CONTROLLO	LUMEN	CCT	FINITURA	CODICE	€
7 W	110°	On-Off	850 lm	3000 K	Bianco	282725	135
7 W	110°	On-Off	850 lm	3000 K	Nero	257839	135
7 W	110°	1-10V	850 lm	3000 K	Bianco	303567	165
7 W	110°	1-10V	850 lm	3000 K	Nero	303550	165
7 W	110°	DALI	850 lm	3000 K	Bianco	286129	185
7 W	110°	DALI	850 lm	3000 K	Nero	286112	185

EGO PENDANT

SISTEMI



MacAdam: SDCM 3 UGR: <19 CRI: ≥90 DURATA LED: 50.000 h



LED COB CITIZEN (UGR <19)

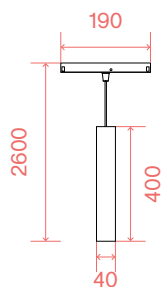

0,540 Kg
0,0038 m³

POTENZA	ANGOLO	CONTROLLO	LUMEN	CCT	FINITURA	CODICE	€
12 W	30°	On-Off	1100 lm	3000 K	Bianco	282879	165
12 W	30°	On-Off	1100 lm	3000 K	Nero	257747	165
12 W	30°	On-Off	1100 lm	3000 K	Ottone	283852	165
12 W	30°	On-Off	1150 lm	4000 K	Nero	321653	165
12 W	30°	1-10V	1100 lm	3000 K	Bianco	303598	200
12 W	30°	1-10V	1100 lm	3000 K	Nero	303574	200
12 W	30°	1-10V	1100 lm	3000 K	Ottone	303581	200
12 W	30°	DALI	1100 lm	3000 K	Bianco	286327	215
12 W	30°	DALI	1100 lm	3000 K	Nero	286310	215
12 W	30°	DALI	1100 lm	3000 K	Ottone	300498	215
12 W	30°	DALI	1150 lm	4000 K	Nero	321837	215

LED COB CITIZEN

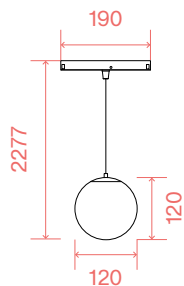

0,650 Kg
0,0125 m³

POTENZA	ANGOLO	CONTROLLO	LUMEN	CCT	FINITURA	CODICE	€
10 W	-	On-Off	1000 lm	3000 K	Bianco	327532	170
10 W	-	On-Off	1000 lm	3000 K	Nero	327525	170

EGO - LOW

SISTEMI

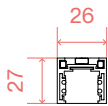

TRACK LOW (KIT DI MONTAGGIO NON NECESSARIO, FISSAGGIO DIRETTO A SOFFITTO
LUNGHEZZA MASSIMA PER PUNTO DI ALIMENTAZIONE: 25 METRI)

LUNGHEZZA	PESO	VOLUME	FINITURA	CODICE	€
1000 mm	0,68 Kg	0,0013 m ³	Bianco	282909	57
1000 mm	0,68 Kg	0,0013 m ³	Nero	257877	57
2000 mm	1,36 Kg	0,0026 m ³	Bianco	282916	115
2000 mm	1,36 Kg	0,0026 m ³	Nero	266121	115

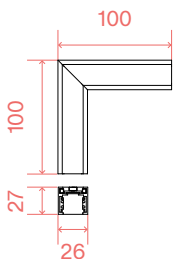

CONNECTOR HORIZONTAL LOW (OPTIONAL)

PESO	VOLUME	CONTROLLO	FINITURA	CODICE	€
0,07 Kg	0,0015 m ³	On-Off	Bianco	282848	95
0,07 Kg	0,0015 m ³	On-Off	Nero	257990	95
0,07 Kg	0,0015 m ³	1-10V / DALI	Bianco	286266	100
0,07 Kg	0,0015 m ³	1-10V / DALI	Nero	286259	100

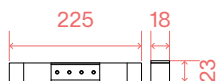

LINEAR CONNECTOR (NECESSARIO - 1 KIT X GIUNZIONE LINEARE)

PESO	VOLUME	CONTROLLO	FINITURA	CODICE	€
0,16 Kg	0,0005 m ³	On-Off	Bianco	285993	50
0,16 Kg	0,0005 m ³	On-Off	Nero	283104	50
0,16 Kg	0,0005 m ³	1-10V / DALI	Bianco	288338	55
0,16 Kg	0,0005 m ³	1-10V / DALI	Nero	289281	55

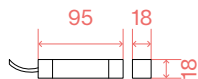

MAIN CONNECTOR (NECESSARIO - 1 KIT X PUNTO DI ALIMENTAZ. MAX 210W)

PESO	VOLUME	CONTROLLO	FINITURA	CODICE	€
0,12 Kg	0,0005 m ³	On-Off	Bianco	282862	36
0,12 Kg	0,0005 m ³	On-Off	Nero	265896	36
0,12 Kg	0,0005 m ³	1-10V / DALI	Bianco	286303	50
0,12 Kg	0,0005 m ³	1-10V / DALI	Nero	286297	50

Lunghezza cavo 2000 mm

	NECESSARIO	MISURA (L X H X P)	FINITURA	CODICE	€
END CAP NO HOLE	SI	26 x 11 x 27 mm	Bianco	282688	6
END CAP NO HOLE	SI	26 x 11 x 27 mm	Nero	267241	6
END CAP WITH HOLE	SI	26 x 11 x 27 mm	Bianco	282671	6
END CAP WITH HOLE	SI	26 x 11 x 27 mm	Nero	267258	6
SUSPENSION KIT	SI - 1 Kit x punto di alimentaz. max 210W	2000 mm	Bianco	282749	55
SUSPENSION KIT		2000 mm	Nero	276328	55
KIT SINGLE CABLE	SI - 1 Kit x 900 mm	2000 mm	Bianco	282756	17
KIT SINGLE CABLE		2000 mm	Nero	259376	17

EGO - LOW - ASSEMBLY PLANS

SISTEMI

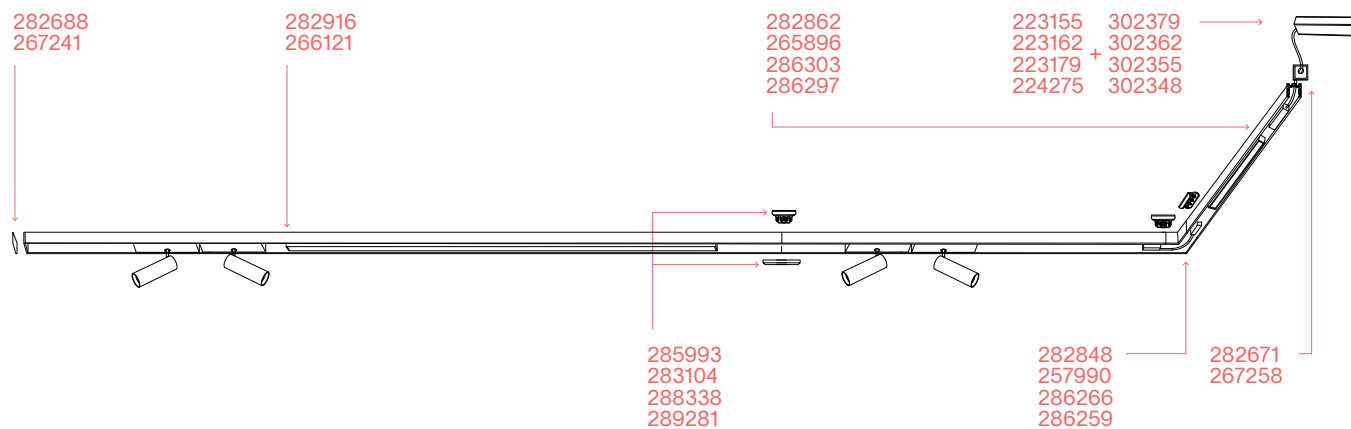
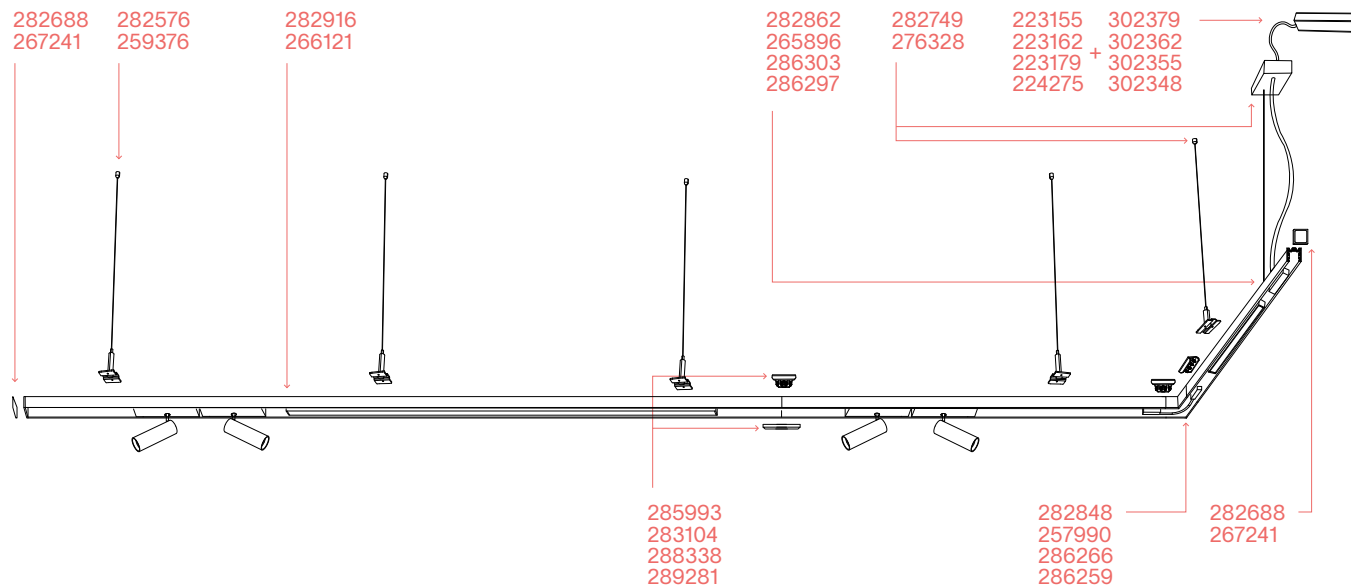

EGO - HIGH

SISTEMI

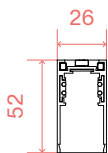

TRACK HIGH (KIT DI MONTAGGIO NON NECESSARIO, FISSAGGIO DIRETTO A SOFFITTO
LUNGHEZZA MASSIMA PER PUNTO DI ALIMENTAZIONE: 25 METRI)

LUNGHEZZA	PESO	VOLUME	FINITURA	CODICE	€
1000 mm	0,80 Kg	0,0023 m ³	Bianco	282886	62
1000 mm	0,80 Kg	0,0023 m ³	Nero	258027	62
2000 mm	1,60 Kg	0,0046 m ³	Bianco	282893	125
2000 mm	1,60 Kg	0,0046 m ³	Nero	266145	125

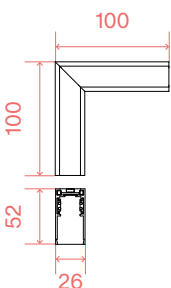

CONNECTOR HORIZONTAL HIGH (OPTIONAL)

PESO	VOLUME	CONTROLLO	FINITURA	CODICE	€
0,10 Kg	0,0015 m ³	On-Off	Bianco	282824	90
0,10 Kg	0,0015 m ³	On-Off	Nero	258140	90
0,10 Kg	0,0015 m ³	1-10V / DALI	Bianco	286228	100
0,10 Kg	0,0015 m ³	1-10V / DALI	Nero	286211	100

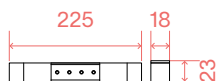

LINEAR CONNECTOR (NECESSARIO - 1 KIT X GIUNZIONE LINEARE)

PESO	VOLUME	CONTROLLO	FINITURA	CODICE	€
0,16 Kg	0,0005 m ³	On-Off	Bianco	285993	50
0,16 Kg	0,0005 m ³	On-Off	Nero	283104	50
0,16 Kg	0,0005 m ³	1-10V / DALI	Bianco	288338	55
0,16 Kg	0,0005 m ³	1-10V / DALI	Nero	289281	55

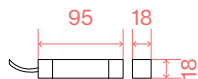

MAIN CONNECTOR (NECESSARIO - 1 KIT X PUNTO DI ALIMENTAZ. MAX 210W)

PESO	VOLUME	CONTROLLO	FINITURA	CODICE	€
0,12 Kg	0,0005 m ³	On-Off	Bianco	282862	36
0,12 Kg	0,0005 m ³	On-Off	Nero	265896	36
0,12 Kg	0,0005 m ³	1-10V / DALI	Bianco	286303	50
0,12 Kg	0,0005 m ³	1-10V / DALI	Nero	286297	50

Lunghezza cavo 2000 mm

	NECESSARIO	MISURA (L X H X P)	FINITURA	CODICE	€
END CAP NO HOLE	SI	26 x 11 x 52 mm	Bianco	282664	6
END CAP NO HOLE	SI	26 x 11 x 52 mm	Nero	267227	6
END CAP WITH HOLE	SI	26 x 11 x 52 mm	Bianco	282657	6
END CAP WITH HOLE	SI	26 x 11 x 52 mm	Nero	267234	6
SUSPENSION KIT	SI - 1 Kit x punto di alimentaz. max 210W	2000 mm	Bianco	282749	55
SUSPENSION KIT		2000 mm	Nero	276328	55
KIT SINGLE CABLE	SI - 1 Kit x 900 mm	2000 mm	Bianco	282756	17
KIT SINGLE CABLE		2000 mm	Nero	259376	17
BLINDED COVER	NO	1000 x 5 x 24 mm	Bianco	282770	17
BLINDED COVER	NO	1000 x 5 x 24 mm	Nero	258256	17

EGO - HIGH - ASSEMBLY PLANS

SISTEMI

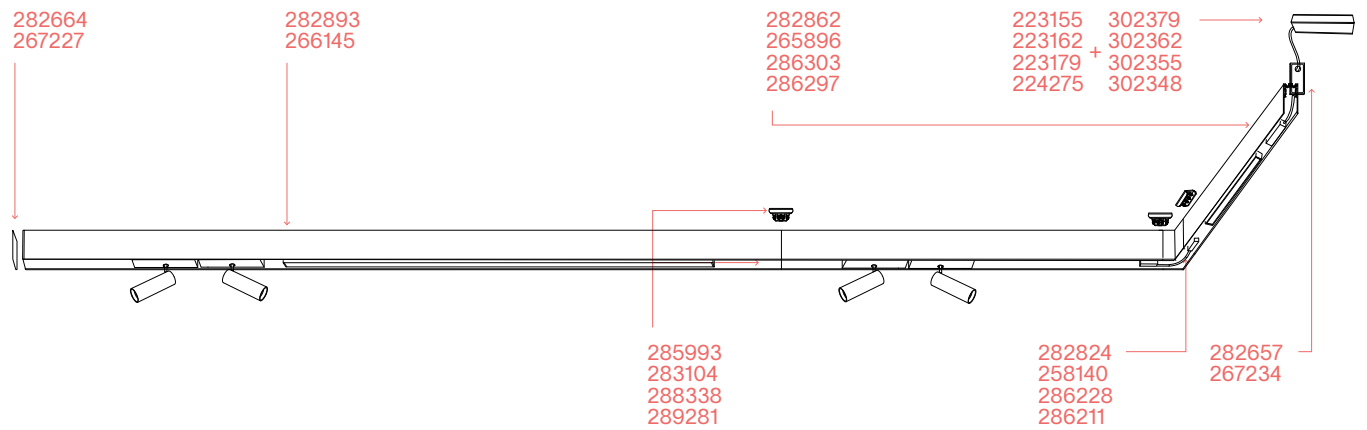
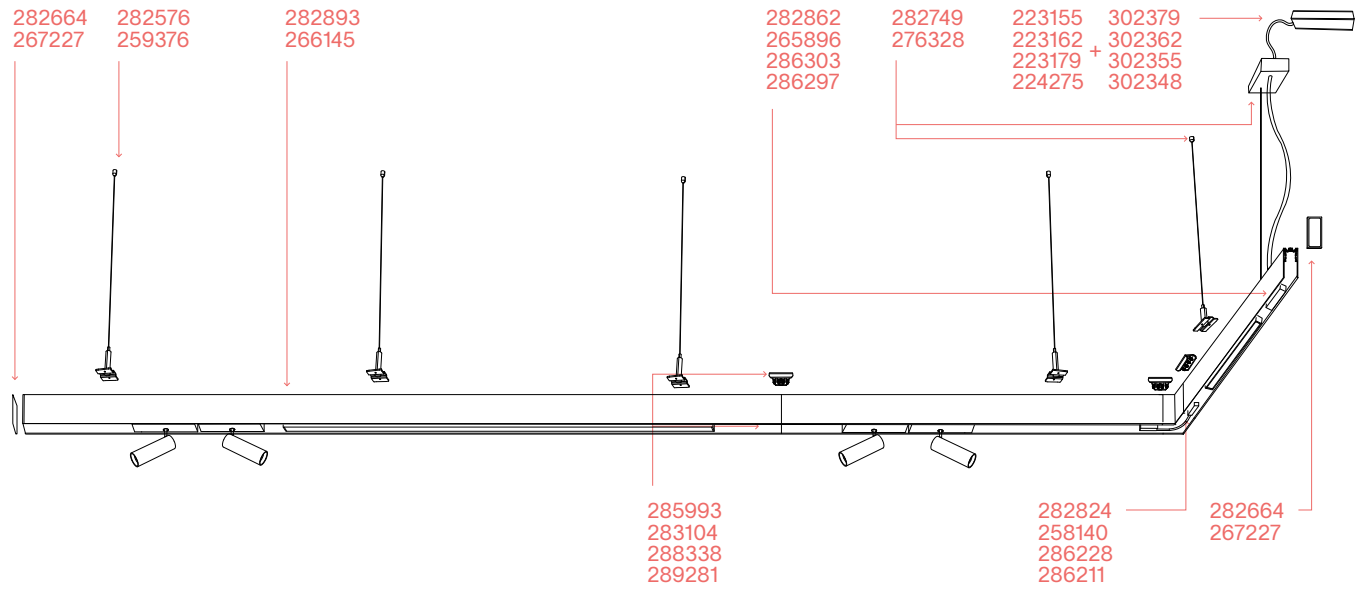

EGO - RECESSED

SISTEMI

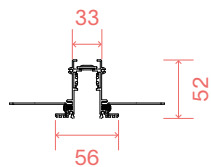

TRACK (KIT PER MONTAGGIO PROFILO INCLUSO
LUNGHEZZA MASSIMA PER PUNTO DI ALIMENTAZIONE: 25 METRI)

LUNGHEZZA	PESO	VOLUME	FINITURA	CODICE	€
1000 mm	1,13 Kg	0,0039 m ³	Bianco	282923	71
1000 mm	1,13 Kg	0,0039 m ³	Nero	258171	71
2000 mm	2,26 Kg	0,0078 m ³	Bianco	282930	150
2000 mm	2,26 Kg	0,0078 m ³	Nero	266183	150

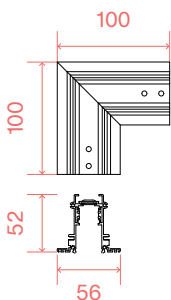

CONNECTOR HORIZONTAL (OPTIONAL)

PESO	VOLUME	CONTROLLO	FINITURA	CODICE	€
0,13 Kg	0,0015 m ³	On-Off	Bianco	282787	90
0,13 Kg	0,0015 m ³	On-Off	Nero	258232	90
0,13 Kg	0,0015 m ³	1-10V / DALI	Bianco	286204	125
0,13 Kg	0,0015 m ³	1-10V / DALI	Nero	286167	125

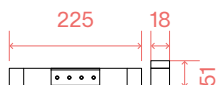

LINEAR CONNECTOR (NECESSARIO - 1 KIT X GIUNZIONE LINEARE)

PESO	VOLUME	CONTROLLO	FINITURA	CODICE	€
0,16 Kg	0,0005 m ³	On-Off	Bianco	286006	50
0,16 Kg	0,0005 m ³	On-Off	Nero	283111	50
0,16 Kg	0,0005 m ³	1-10V / DALI	Bianco	289298	55
0,16 Kg	0,0005 m ³	1-10V / DALI	Nero	289304	55

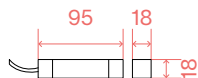

MAIN CONNECTOR (NECESSARIO - 1 KIT X PUNTO DI ALIMENTAZ. MAX 210W)

PESO	VOLUME	CONTROLLO	FINITURA	CODICE	€
0,12 Kg	0,0005 m ³	On-Off	Bianco	282862	36
0,12 Kg	0,0005 m ³	On-Off	Nero	265896	36
0,12 Kg	0,0005 m ³	1-10V / DALI	Bianco	286303	50
0,12 Kg	0,0005 m ³	1-10V / DALI	Nero	286297	50

Lunghezza cavo 2000 mm

	NECESSARIO	MISURA (L X H X P)	FINITURA	CODICE	€
END CAP NO HOLE	SI	36 x 4 x 52 mm	Bianco	282701	5
END CAP NO HOLE	SI	36 x 4 x 52 mm	Nero	267203	5
END CAP WITH HOLE	SI	36 x 4 x 52 mm	Bianco	282695	6
END CAP WITH HOLE	SI	36 x 4 x 52 mm	Nero	267210	6
BLINDED COVER	NO	1000 x 5 x 24 mm	Bianco	282770	17
BLINDED COVER	NO	1000 x 5 x 24 mm	Nero	258256	17
INSTALLATION TOOL	NO		Nero	292922	31

EGO - RECESSED - ASSEMBLY PLANS

SISTEMI

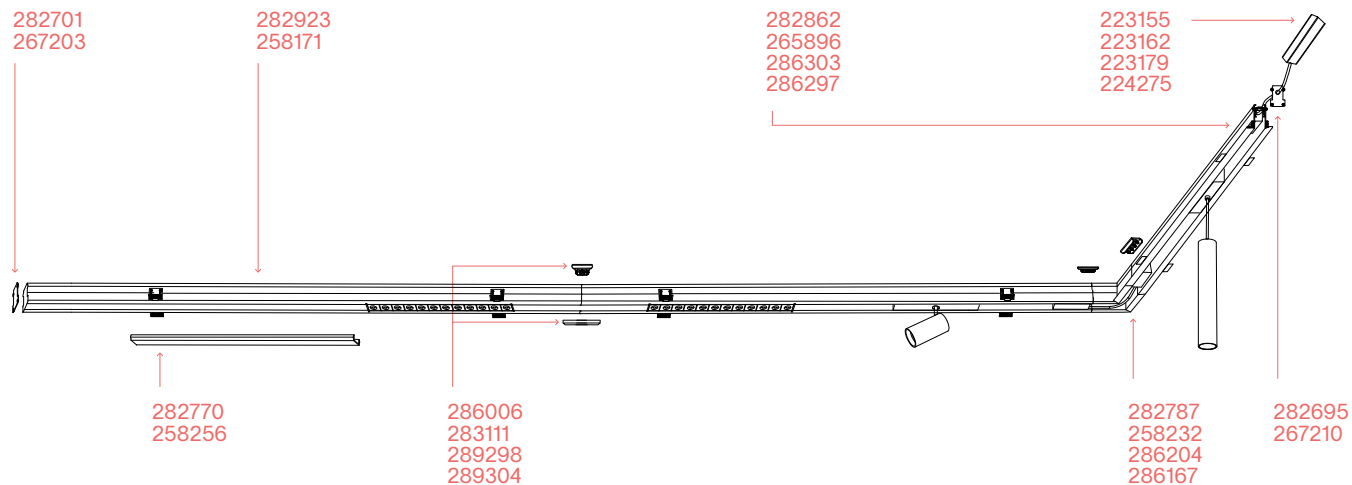

EGO - RECESSED EASY

SISTEMI

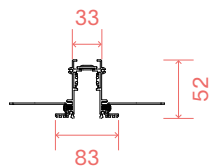

TRACK (KIT DI MONTAGGIO NON NECESSARIO, FISSAGGIO DIRETTO A SOFFITTO
LUNGHEZZA MASSIMA PER PUNTO DI ALIMENTAZIONE: 25 METRI)

LUNGHEZZA	PESO	VOLUME	FINITURA	CODICE	€
1000 mm	1,16 Kg	0,0058 m ³	Bianco	320489	85
1000 mm	1,16 Kg	0,0058 m ³	Nero	320472	85
2000 mm	2,40 Kg	0,0122 m ³	Bianco	320502	170
2000 mm	2,40 Kg	0,0122 m ³	Nero	320496	170

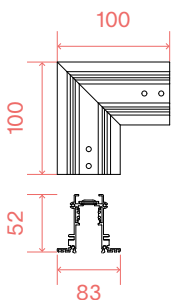

CONNECTOR HORIZONTAL (OPTIONAL)

PESO	VOLUME	CONTROLLO	FINITURA	CODICE	€
0,30 Kg	0,0010 m ³	On-Off	Bianco	320748	115
0,30 Kg	0,0010 m ³	On-Off	Nero	320731	115
0,30 Kg	0,0010 m ³	1-10V / DALI	Bianco	320724	135
0,30 Kg	0,0010 m ³	1-10V / DALI	Nero	320717	135

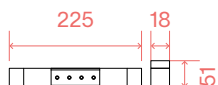

LINEAR CONNECTOR (NECESSARIO - 1 KIT X GIUNZIONE LINEARE)

PESO	VOLUME	CONTROLLO	FINITURA	CODICE	€
0,16 Kg	0,0005 m ³	On-Off	Bianco	286006	50
0,16 Kg	0,0005 m ³	On-Off	Nero	283111	50
0,16 Kg	0,0005 m ³	1-10V / DALI	Bianco	289298	55
0,16 Kg	0,0005 m ³	1-10V / DALI	Nero	289304	55

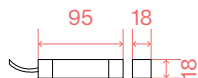

MAIN CONNECTOR (NECESSARIO - 1 KIT X PUNTO DI ALIMENTAZ. MAX 210W)

PESO	VOLUME	CONTROLLO	FINITURA	CODICE	€
0,12 Kg	0,0005 m ³	On-Off	Bianco	282862	36
0,12 Kg	0,0005 m ³	On-Off	Nero	265896	36
0,12 Kg	0,0005 m ³	1-10V / DALI	Bianco	286303	50
0,12 Kg	0,0005 m ³	1-10V / DALI	Nero	286297	50

Lunghezza cavo 2000 mm

	NECESSARIO	MISURA (L X H X P)	FINITURA	CODICE	€
END CAP NO HOLE	SI	83 x 52 x 30 mm	Bianco	320564	8
END CAP NO HOLE	SI	83 x 52 x 30 mm	Nero	320557	8
END CAP WITH HOLE	SI	83 x 52 x 30 mm	Bianco	320588	10
END CAP WITH HOLE	SI	83 x 52 x 30 mm	Nero	320571	10
BLINDED COVER	NO	1000 x 5 x 24 mm	Bianco	282770	17
BLINDED COVER	NO	1000 x 5 x 24 mm	Nero	258256	17

EGO - RECESSED EASY - ASSEMBLY PLANS

SISTEMI

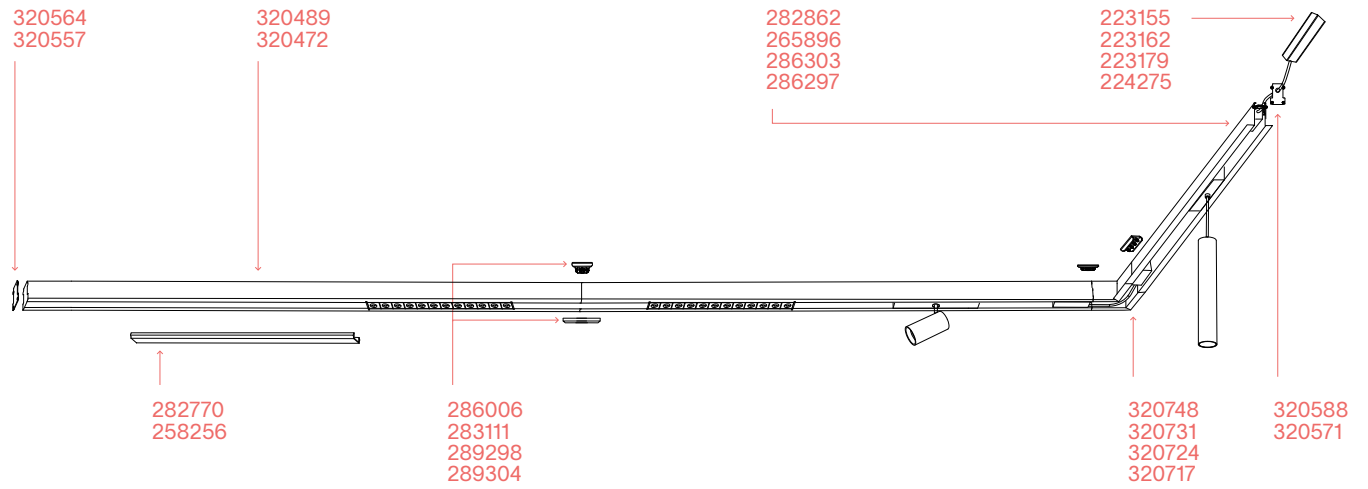

EGO - RECESSED TRIM

SISTEMI

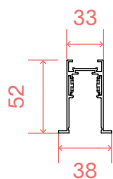

TRACK (KIT PER MONTAGGIO PROFILO INCLUSO
LUNGHEZZA MASSIMA PER PUNTO DI ALIMENTAZIONE: 25 METRI)

LUNGHEZZA	PESO	VOLUME	FINITURA	CODICE	€
1000 mm	1,13 Kg	0,0058 m ³	Bianco	320441	85
1000 mm	1,13 Kg	0,0058 m ³	Nero	320434	85
2000 mm	2,25 Kg	0,0122 m ³	Bianco	320465	170
2000 mm	2,25 Kg	0,0122 m ³	Nero	320458	170

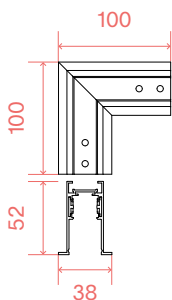

CONNECTOR HORIZONTAL (OPTIONAL)

PESO	VOLUME	CONTROLLO	FINITURA	CODICE	€
0,30 Kg	0,0010 m ³	On-Off	Bianco	320625	125
0,30 Kg	0,0010 m ³	On-Off	Nero	320618	125
0,30 Kg	0,0010 m ³	1-10V / DALI	Bianco	320601	145
0,30 Kg	0,0010 m ³	1-10V / DALI	Nero	320595	145

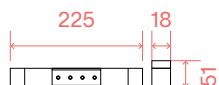

LINEAR CONNECTOR (NECESSARIO - 1 KIT X GIUNZIONE LINEARE)

PESO	VOLUME	CONTROLLO	FINITURA	CODICE	€
0,16 Kg	0,0005 m ³	On-Off	Bianco	286006	50
0,16 Kg	0,0005 m ³	On-Off	Nero	283111	50
0,16 Kg	0,0005 m ³	1-10V / DALI	Bianco	289298	55
0,16 Kg	0,0005 m ³	1-10V / DALI	Nero	289304	55

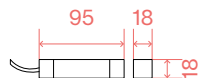

MAIN CONNECTOR (NECESSARIO - 1 KIT X PUNTO DI ALIMENTAZ. MAX 210W)

PESO	VOLUME	CONTROLLO	FINITURA	CODICE	€
0,12 Kg	0,0005 m ³	On-Off	Bianco	282862	36
0,12 Kg	0,0005 m ³	On-Off	Nero	265896	36
0,12 Kg	0,0005 m ³	1-10V / DALI	Bianco	286303	50
0,12 Kg	0,0005 m ³	1-10V / DALI	Nero	286297	50

Lunghezza cavo 2000 mm

	NECESSARIO	MISURA (L X H X P)	FINITURA	CODICE	€
END CAP NO HOLE	SI	38 x 52 x 17 mm	Bianco	320526	6
END CAP NO HOLE	SI	38 x 52 x 17 mm	Nero	320519	6
END CAP WITH HOLE	SI	38 x 52 x 17 mm	Bianco	320540	9
END CAP WITH HOLE	SI	38 x 52 x 17 mm	Nero	320533	9
BLINDED COVER	NO	1000 x 5 x 24 mm	Bianco	282770	17
BLINDED COVER	NO	1000 x 5 x 24 mm	Nero	258256	17

EGO - RECESSED TRIM - ASSEMBLY PLANS

SISTEMI

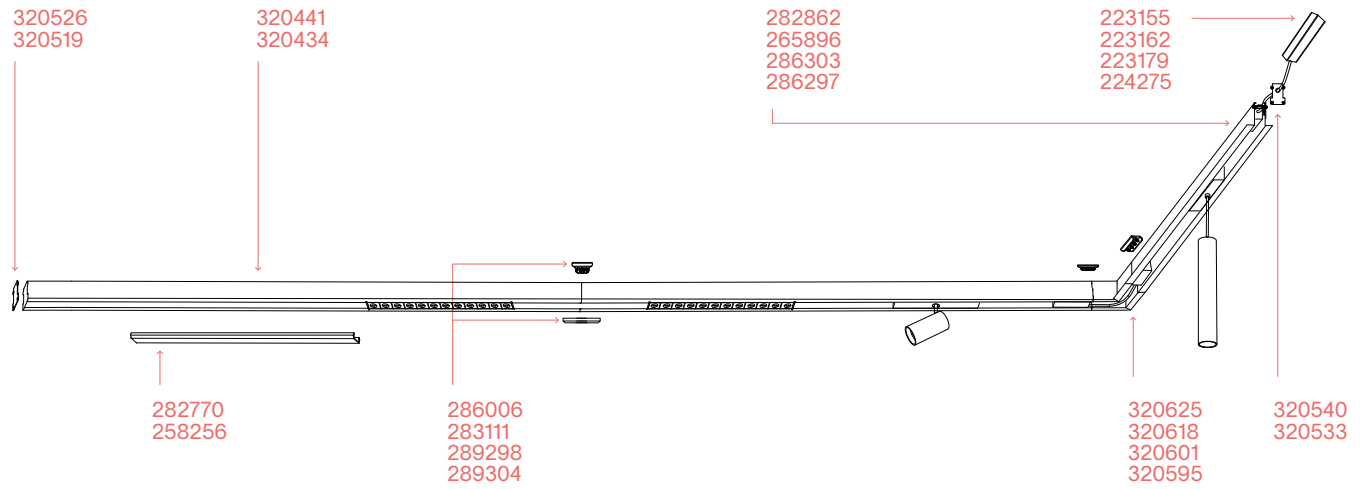

EGO - DRIVERS

SISTEMI

DRIVER MEANWELL ON/OFF (NECESSARIO)

POTENZA	OUTPUT	MISURA (L X H X P)	DRIVER BOX	CODICE	€
75 W	48 Vdc	171x37x62 mm	255x55x75 mm	223155	140
100 W	48 Vdc	220x37x68 mm	330x60x80 mm	223162	185
150 W	48 Vdc	228x37x68 mm	330x60x80 mm	223179	205
240 W	48 Vdc	244x39x68 mm	330x60x80 mm	224275	230

DRIVER BOX (OPTIONAL)

MATERIALE	MISURE	FINITURA	CODICE	€
Metal	255x55x75 mm	Bianco	302379	25
Metal	255x55x75 mm	Nero	302362	25
Metal	330x60x80 mm	Bianco	302355	30
Metal	330x60x80 mm	Nero	302348	30

MAGNETIC DRIVER (NECESSARIO - LUNGHEZZA CAVO 2000 mm SOSTITUISCE DRIVER + MAIN CONNECTOR*)

POTENZA	OUTPUT	MISURA (L X H X P)	CODICE	€
100 W	48 Vdc	297x20x16 mm	296302	90
150 W	48 Vdc	268x43x16 mm	325750	95
250 W	48 Vdc	268x43x16 mm	325767	110

*Codici 325750 e 325767 consigliati per l'impiego nelle versioni HIGH e RECESSED.

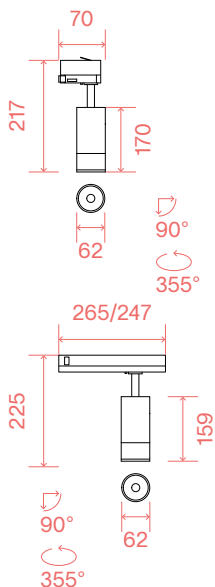

0,710 Kg
0,0042 m³

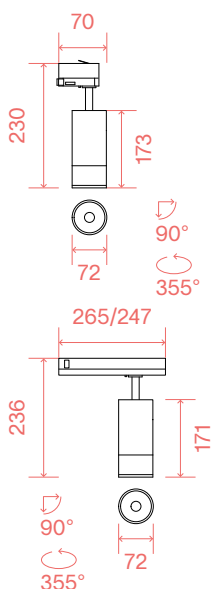

1,100 Kg
0,0050 m³

LED COB BRIDGELUX (DRIVER INCLUSO)

POTENZA	ANGOLO	CONTROLLO	LUMEN	CCT	FINITURA	CODICE	€
15 W	20-55°	On-Off	1550 lm	3000 K	Bianco	286594	73
15 W	20-55°	On-Off	1550 lm	3000 K	Nero	276182	73
15 W	20-55°	On-Off	1600 lm	4000 K	Bianco	322094	73
15 W	20-55°	On-Off	1600 lm	4000 K	Nero	322087	73
15 W	20-55°	1-10V	1550 lm	3000 K	Bianco	302959	116
15 W	20-55°	1-10V	1550 lm	3000 K	Nero	302942	116
15 W	20-55°	DALI	1550 lm	3000 K	Bianco	302997	135
15 W	20-55°	DALI	1550 lm	3000 K	Nero	302980	135

LED COB BRIDGELUX (DRIVER INCLUSO)

POTENZA	ANGOLO	CONTROLLO	LUMEN	CCT	FINITURA	CODICE	€
25 W	20-55°	On-Off	2250 lm	3000 K	Bianco	286600	92
25 W	20-55°	On-Off	2250 lm	3000 K	Nero	276243	92
25 W	20-55°	On-Off	2700 lm	4000 K	Bianco	322124	92
25 W	20-55°	On-Off	2700 lm	4000 K	Nero	322100	92
25 W	20-55°	1-10V	2550 lm	3000 K	Bianco	302973	135
25 W	20-55°	1-10V	2550 lm	3000 K	Nero	302966	135
25 W	20-55°	DALI	2550 lm	3000 K	Bianco	303017	155
25 W	20-55°	DALI	2550 lm	3000 K	Nero	303000	155

	NECESSARIO	DRIVER	FINITURA	CODICE	€
SINGLE CONNECTION	NO	On/Off	Bianco	170145	27
SINGLE CONNECTION	NO	On/Off	Nero	170152	27

FLUO ACCENT

SISTEMI



IP20 MacAdam: SDCM 3 UGR: <13 CRI: ≥80 DURATA LED: 50.000 h



2,760 Kg
0,0183 m³
Lunghezza cavo
2150 mm

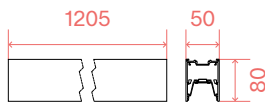

LED SMD OSRAM (DRIVER TRIDONIC ON/OFF INCLUSO)

POTENZA	ANGOLO	LUMEN	CCT	FINITURA	CODICE	€
30 W	30°	2750 lm	3000 K	Bianco	192611	360
30 W	30°	2750 lm	3000 K	Nero	192581	360
30 W	30°	2900 lm	4000 K	Bianco	192543	360
30 W	30°	2900 lm	4000 K	Nero	192529	360

DIMMABLE DRIVER* (NON INCLUSO/OPTIONAL)

	POTENZA	OUTPUT	MISURE	CODICE	€
1-10V	39 W	700 mA	280 x 21 x 30 mm	216416	145
DALI/Push	38 W	700 mA	280 x 21 x 30 mm	216270	160

*Gli alimentatori dimmerabili devono essere ordinati contestualmente al prodotto e verranno già inclusi all'interno degli apparecchi in sostituzione degli alimentatori on-off. La connessione in linea è disponibile soltanto per le versioni on-off dei prodotti.

3,860 Kg
0,0257 m³
Lunghezza cavo
2150 mm

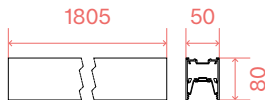

LED SMD OSRAM (DRIVER TRIDONIC ON/OFF INCLUSO)

POTENZA	ANGOLO	LUMEN	CCT	FINITURA	CODICE	€
30 W	30°	2750 lm	3000 K	Bianco	192499	430
30 W	30°	2750 lm	3000 K	Nero	192475	430
30 W	30°	2900 lm	4000 K	Bianco	192444	430
30 W	30°	2900 lm	4000 K	Nero	192420	430

DIMMABLE DRIVER* (NON INCLUSO/OPTIONAL)

	POTENZA	OUTPUT	MISURE	CODICE	€
1-10V	39 W	700 mA	280 x 21 x 30 mm	216416	145
DALI/Push	38 W	700 mA	280 x 21 x 30 mm	216270	160

*Gli alimentatori dimmerabili devono essere ordinati contestualmente al prodotto e verranno già inclusi all'interno degli apparecchi in sostituzione degli alimentatori on-off. La connessione in linea è disponibile soltanto per le versioni on-off dei prodotti.

FLUO WIDE

SISTEMI



IP20

MacAdam: SDCM 3

CRI: ≥80

DURATA LED: 50.000 h



FOTO p. 324

2,890 Kg
0,0183 m³
Lunghezza cavo
2150 mm

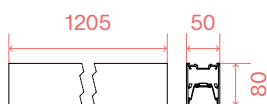

LED SMD SAMSUNG (DRIVER TRIDONIC ON/OFF INCLUSO)

POTENZA	ANGOLO	LUMEN	CCT	FINITURA	CODICE	€
27 W	105°	3750 lm	3000 K	Bianco	192437	330
27 W	105°	3750 lm	3000 K	Nero	191997	330
27 W	105°	4050 lm	4000 K	Bianco	192482	330
27 W	105°	4050 lm	4000 K	Nero	192505	330

DIMMABLE DRIVER* (NON INCLUSO/OPTIONAL)

	POTENZA	OUTPUT	MISURE	CODICE	€
1-10V	28 W	500 mA	280 x 21 x 30 mm	216423	145
DALI/Push	27 W	500 mA	280 x 21 x 30 mm	216287	160

*Gli alimentatori dimmerabili devono essere ordinati contestualmente al prodotto e verranno già inclusi all'interno degli apparecchi in sostituzione degli alimentatori on-off. La connessione in linea è disponibile soltanto per le versioni on-off dei prodotti.

4,420 Kg
0,0257 m³
Lunghezza cavo
2150 mm

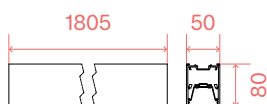

LED SMD SAMSUNG (DRIVER TRIDONIC ON/OFF INCLUSO)

POTENZA	ANGOLO	LUMEN	CCT	FINITURA	CODICE	€
36 W	105°	5050 lm	3000 K	Bianco	192550	425
36 W	105°	5050 lm	3000 K	Nero	192567	425
36 W	105°	5300 lm	4000 K	Bianco	192604	425
36 W	105°	5300 lm	4000 K	Nero	192628	425

DIMMABLE DRIVER* (NON INCLUSO/OPTIONAL)

	POTENZA	OUTPUT	MISURE	CODICE	€
1-10V	39 W	700 mA	280 x 21 x 30 mm	216416	145
DALI/Push	38 W	700 mA	280 x 21 x 30 mm	216270	160

*Gli alimentatori dimmerabili devono essere ordinati contestualmente al prodotto e verranno già inclusi all'interno degli apparecchi in sostituzione degli alimentatori on-off. La connessione in linea è disponibile soltanto per le versioni on-off dei prodotti.

FLUO BI-EMISSION*

SISTEMI



IP20 MacAdam: SDCM 3 CRI: ≥80 DURATA LED: 50.000 h



2,890 Kg
0,0183 m³
Lunghezza cavo
2150 mm

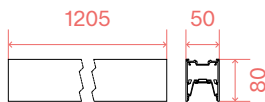

LED SMD SAMSUNG (UP-LIGHT INCLUSA - DRIVER TRIDONIC ON/OFF INCLUSO)

POTENZA	ANGOLO	LUMEN	CCT	FINITURA	CODICE	€
27 W	105°	3250 lm	3000 K	Bianco	192666	425
27 W	105°	3250 lm	3000 K	Nero	192710	425
27 W	105°	4050 lm	4000 K	Bianco	192741	425
27 W	105°	4050 lm	4000 K	Nero	192758	425

UP-LIGHT INFO

KIT DIMMABLE DRIVER*

POTENZA	ANGOLO	LUMEN	CCT		CODICE	€
13 W	105°	1750 lm	3000 K	1-10V	270692	230
13 W	105°	2050 lm	4000 K	DALI/Push	270876	260

*Accensione separata dell'emissione diretta e indiretta (disponibile solo per versioni on-off). Regolazione in sincronia dell'emissione diretta e indiretta (versioni con dimmerazione 1-10V e Push). Gli alimentatori dimmerabili devono essere ordinati contestualmente al prodotto e verranno già inclusi all'interno degli apparecchi in sostituzione degli alimentatori on-off. La connessione in linea è disponibile soltanto per le versioni on-off dei prodotti.

4,420 Kg
0,0269 m³
Lunghezza cavo
2150 mm

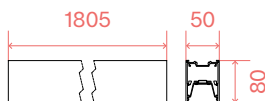

LED SMD SAMSUNG (UP-LIGHT INCLUSA - DRIVER TRIDONIC ON/OFF INCLUSO)

POTENZA	ANGOLO	LUMEN	CCT	FINITURA	CODICE	€
36 W	105°	5050 lm	3000 K	Bianco	192703	580
36 W	105°	5050 lm	3000 K	Nero	192697	580
36 W	105°	5350 lm	4000 K	Bianco	192673	580
36 W	105°	5350 lm	4000 K	Nero	192642	580

UP-LIGHT INFO

KIT DIMMABLE DRIVER*

POTENZA	ANGOLO	LUMEN	CCT		CODICE	€
18 W	105°	2550 lm	3000 K	1-10V	270883	230
18 W	105°	2800 lm	4000 K	DALI/Push	270937	260

*Accensione separata dell'emissione diretta e indiretta (disponibile solo per versioni on-off). Regolazione in sincronia dell'emissione diretta e indiretta (versioni con dimmerazione 1-10V e Push). Gli alimentatori dimmerabili devono essere ordinati contestualmente al prodotto e verranno già inclusi all'interno degli apparecchi in sostituzione degli alimentatori on-off. La connessione in linea è disponibile soltanto per le versioni on-off dei prodotti.

FLUO - ASSEMBLY PLANS

SISTEMI

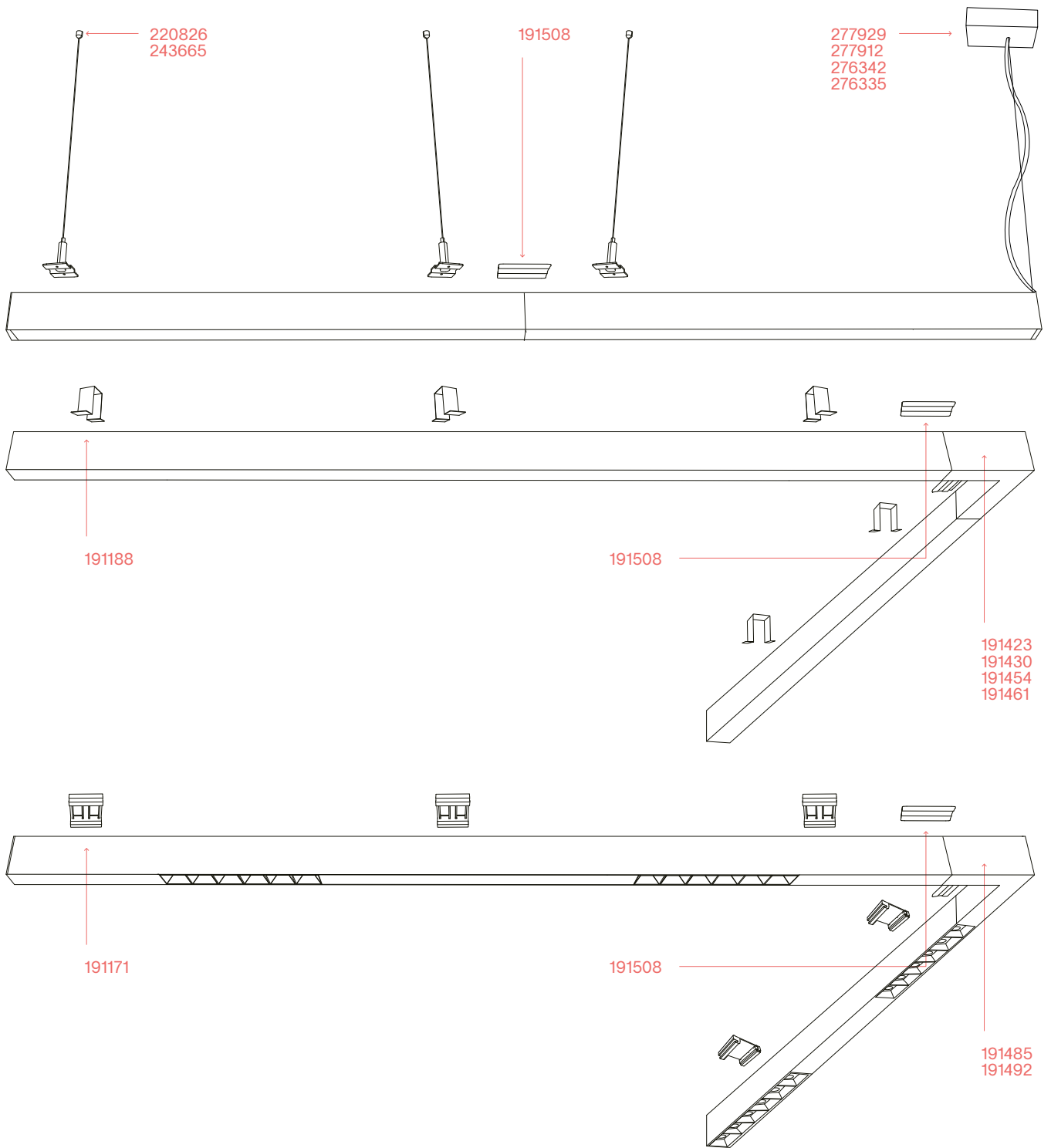

FLUO - MOUNTING KIT

SISTEMI

	NECESSARIO	N' CAVI	LUNGHEZZA CAVI	FINITURA	CODICE	€
KIT SUSPENSION		1	2000 mm	Bianco	277929	32
KIT SUSPENSION	SI	1	2000 mm	Nero	277912	32
KIT SUSPENSION	1 Kit x punto di alimentazione	1	5000 mm	Bianco	276342	43
KIT SUSPENSION		1	5000 mm	Nero	276335	43
KIT SINGLE CABLE	SI - 1 Kit x 600 mm	1	2000 mm		220826	13
KIT SINGLE CABLE	SI - 1 Kit x 600 mm	1	5000 mm		243665	20
KIT RECESSED	SI - 1 Kit x 600 mm	1			191188	25
KIT SURFACE	SI - 1 Kit x 600 mm	1			191171	25

FLUO - OPTIONAL

SISTEMI

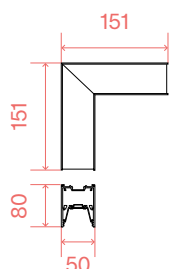

CORNER (OPTIONAL - DRIVER ON/OFF INCLUSO - COMPATIBILE CON VERSIONE WIDE)

POTENZA	ANGOLO	LUMEN	CCT	FINITURA	CODICE	€
8 W	105°	950 lm	3000 K	Bianco	191423	120
8 W	105°	950 lm	3000 K	Nero	191430	120
8 W	105°	1000 lm	4000 K	Bianco	191454	120
8 W	105°	1000 lm	4000 K	Nero	191461	120

0,580 Kg
0,0023 m³

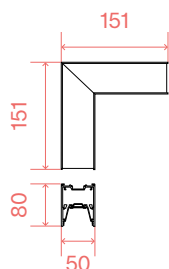

BLINDED CORNER (OPTIONAL - COMPATIBILE CON VERSIONE ACCENT)

FINITURA	CODICE	€
Bianco	191485	65
Nero	191492	65

STRUCTURE CONNECTOR (LUNGHEZZA MAX PER PUNTO DI ALIMENTAZIONE: 30 METRI)

NECESSARIO	CODICE	€
SI - 1 Kit x giunzione	191508	12

0,580 Kg
0,0023 m³

FOX 8W

⊕ ON-OFF □ 1-10V/DALI

PROIETTORI

IP20 MacAdam: SDCM 3 CRI: $\geq 80 / \geq 90$ DURATA LED: 30.000 h

↑ FOTO p. 330

ON/OFF

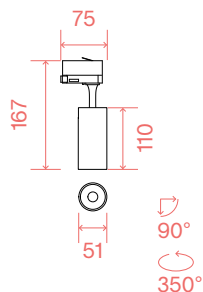

LED COB BRIDGELUX (DRIVER INCLUSO)

CRI ≥ 80

POTENZA	ANGOLO	CONTROLLO	LUMEN	CCT	FINITURA	CODICE	€
8 W	41°	On-Off	1050 lm	3000 K	Bianco	250410	49
8 W	41°	On-Off	1050 lm	3000 K	Nero	250403	49
8 W	41°	On-Off	1050 lm	3000 K	Ottone	283920	49
8 W	41°	On-Off	1100 lm	4000 K	Bianco	271453	49
8 W	41°	On-Off	1100 lm	4000 K	Nero	271446	49

1-10V

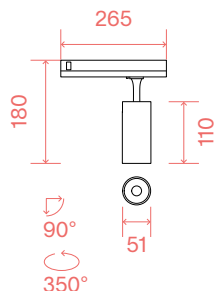

CRI ≥ 80

POTENZA	ANGOLO	CONTROLLO	LUMEN	CCT	FINITURA	CODICE	€
8 W	41°	On-Off	850 lm	3000 K	Bianco	285368	49
8 W	41°	On-Off	850 lm	3000 K	Nero	285351	49
8 W	41°	On-Off	950 lm	4000 K	Bianco	322339	49
8 W	41°	On-Off	950 lm	4000 K	Nero	322322	49
8 W	41°	1-10V	850 lm	3000 K	Bianco	302546	85
8 W	41°	1-10V	850 lm	3000 K	Nero	302539	85

0,300 Kg
0,0015 m³

	NECESSARIO	ANGOLO	DRIVER	FINITURA	CODICE	€
LENS*	NO	23°		Trasparente	302744	5
SINGLE CONNECTION	NO		On/Off	Bianco	170145	27
SINGLE CONNECTION	NO		On/Off	Nero	170152	27

*La lente deve essere ordinata contestualmente al prodotto e verrà montata nel prodotto al posto della lente standard inclusa.

FOX 15W

 **ON-OFF**
 **1-10V/DALI**

PROIETTORI

IP20 MacAdam: SDCM 3 CRI: $\geq 80 / \geq 90$ DURATA LED: 30.000 h

ON/OFF

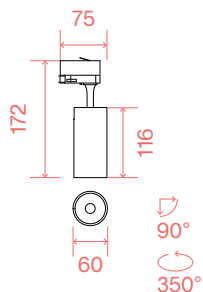

LED COB BRIDGELUX (DRIVER INCLUSO)

CRI ≥ 80

POTENZA	ANGOLO	CONTROLLO	LUMEN	CCT	FINITURA	CODICE	€
15 W	41°	On-Off	1700 lm	3000 K	Bianco	250434	55
15 W	41°	On-Off	1700 lm	3000 K	Nero	250427	55
15 W	41°	On-Off	1700 lm	3000 K	Ottone	283937	55
15 W	41°	On-Off	1750 lm	4000 K	Bianco	267784	55
15 W	41°	On-Off	1750 lm	4000 K	Nero	267777	55

1-10V/DALI

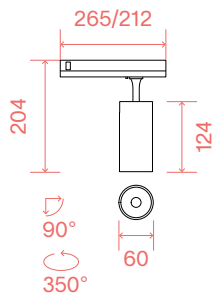

CRI ≥ 90

POTENZA	ANGOLO	CONTROLLO	LUMEN	CCT	FINITURA	CODICE	€
15 W	41°	On-Off	1550 lm	3000 K	Bianco	285382	55
15 W	41°	On-Off	1550 lm	3000 K	Nero	285375	55
15 W	41°	On-Off	1600 lm	4000 K	Bianco	322360	55
15 W	41°	On-Off	1600 lm	4000 K	Nero	322346	55
15 W	41°	1-10V	1550 lm	3000 K	Bianco	302560	90
15 W	41°	1-10V	1550 lm	3000 K	Nero	302553	90
15 W	41°	DALI	1550 lm	3000 K	Bianco	302584	110
15 W	41°	DALI	1550 lm	3000 K	Nero	302577	110

0,380 Kg
0,0020 m³

	NECESSARIO	ANGOLO	DRIVER	FINITURA	CODICE	€
LENS*	NO	15°		Trasparente	302751	5
SINGLE CONNECTION	NO		On/Off	Bianco	170145	27
SINGLE CONNECTION	NO		On/Off	Nero	170152	27

*La lente deve essere ordinata contestualmente al prodotto e verrà montata nel prodotto al posto della lente standard inclusa.

FOX 25W

 **ON-OFF**
 **1-10V/DALI**

PROIETTORI

IP20 MacAdam: SDCM 3 CRI: $\geq 80 / \geq 90$ DURATA LED: 30.000 h

ON/OFF

LED COB BRIDGELUX (DRIVER INCLUSO)

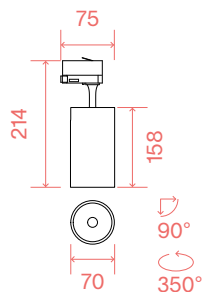

CRI ≥ 80

POTENZA	ANGOLO	CONTROLLO	LUMEN	CCT	FINITURA	CODICE	€
25 W	35°	On-Off	2950 lm	3000 K	Bianco	250458	60
25 W	35°	On-Off	2950 lm	3000 K	Nero	250441	60
25 W	35°	On-Off	2950 lm	3000 K	Ottone	283944	60
25 W	35°	On-Off	3050 lm	4000 K	Bianco	267807	60
25 W	35°	On-Off	3050 lm	4000 K	Nero	267791	60

1-10V/DALI

CRI ≥ 90

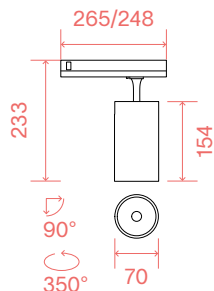

POTENZA	ANGOLO	CONTROLLO	LUMEN	CCT	FINITURA	CODICE	€
25 W	35°	On-Off	2550 lm	3000 K	Bianco	285405	60
25 W	35°	On-Off	2550 lm	3000 K	Nero	285399	60
25 W	35°	On-Off	2700 lm	4000 K	Bianco	322391	60
25 W	35°	On-Off	2700 lm	4000 K	Nero	322377	60
25 W	35°	1-10V	2550 lm	3000 K	Bianco	302607	100
25 W	35°	1-10V	2550 lm	3000 K	Nero	302591	100
25 W	35°	DALI	2550 lm	3000 K	Bianco	302621	115
25 W	35°	DALI	2550 lm	3000 K	Nero	302614	115

0,540 Kg
0,0027 m³

	NECESSARIO	ANGOLO	DRIVER	FINITURA	CODICE	€
LENS*	NO	15°		Trasparente	302768	5
SINGLE CONNECTION	NO		On/Off	Bianco	170145	27
SINGLE CONNECTION	NO		On/Off	Nero	170152	27

*La lente deve essere ordinata contestualmente al prodotto e verrà montata nel prodotto al posto della lente standard inclusa.

GAME TRIM ROUND

DA INCASSO



IP20 / 65 UGR:<19 CRI: ≥80 / ≥90 DURATA LED: 50.000 h

↑ FOTO p. 358

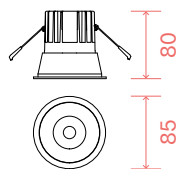

75

0,350 Kg
0,0016 m³

LED COB CREE (DRIVER ON/OFF INCLUSO - CRI ≥80)

ESTERNO BIANCO

POTENZA	ANGOLO	LUMEN	CCT	FINITURA	CODICE	€
11 W	36°	1000 lm	2700 K	Bianco	285429	47
11 W	36°	1100 lm	3000 K	Argento	192284	47
11 W	36°	1100 lm	3000 K	Bianco	192291	47
11 W	36°	1100 lm	3000 K	Nero	192277	47
11 W	36°	1100 lm	3000 K	Oro	192307	47
11 W	36°	1250 lm	4000 K	Bianco	267975	47

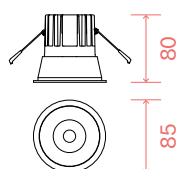

75

0,350 Kg
0,0016 m³

LED COB CREE (DRIVER ON/OFF INCLUSO - CRI ≥80)

ESTERNO NERO

POTENZA	ANGOLO	LUMEN	CCT	FINITURA	CODICE	€
11 W	36°	1000 lm	2700 K	Nero	285412	47
11 W	36°	1100 lm	3000 K	Argento	192321	47
11 W	36°	1100 lm	3000 K	Bianco	192338	47
11 W	36°	1100 lm	3000 K	Nero	192314	47
11 W	36°	1100 lm	3000 K	Oro	192345	47
11 W	36°	1250 lm	4000 K	Nero	267968	47

IP65

POTENZA	ANGOLO	LUMEN	CCT	FINITURA	CODICE	€
11 W	36°	1100 lm	3000 K	Bianco	313191	75
11 W	36°	1100 lm	3000 K	Nero	327754	75

DIMMABLE DRIVER* (NON INCLUSO/OPTIONAL)

	POTENZA	OUTPUT	MISURE	CODICE	€
1-10V/Push	20 W	250 mA	111 x 22 x 52 mm	217253	60
DALI/Push	12 W	250 mA	132 x 20 x 30 mm	202396	60

*Gli alimentatori dimmerabili devono essere ordinati contestualmente al prodotto e verranno già inclusi all'interno degli apparecchi in sostituzione degli alimentatori on-off.

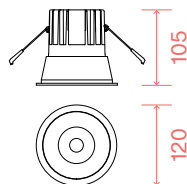

110

0,660 Kg
0,0033 m³

LED COB BRIDGELUX (DRIVER ON/OFF INCLUSO - CRI ≥90)

POTENZA	ANGOLO	LUMEN	CCT	FINITURA	CODICE	€
20W	24°	2350 lm	3000 K	Bianco	273174	90
20W	24°	2350 lm	3000 K	Nero	273167	90

GAME TRIM SQUARE

DA INCASSO

□ IP20 / 65 UGR:<19 CRI:≥80 DURATA LED: 50.000 h

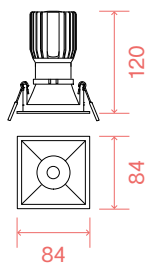

75x75

0,310 Kg
0,0016 m³

LED COB CREE (DRIVER ON/OFF INCLUSO - CRI ≥80)

ESTERNO BIANCO

POTENZA	ANGOLO	LUMEN	CCT	FINITURA	CODICE	€
11 W	36°	1000 lm	2700 K	Bianco	285443	47
11 W	36°	1100 lm	3000 K	Bianco	192376	47
11 W	36°	1100 lm	3000 K	Nero	192352	47

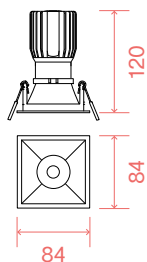

75x75

0,310 Kg
0,0016 m³

LED COB CREE (DRIVER ON/OFF INCLUSO - CRI ≥80)

ESTERNO NERO

POTENZA	ANGOLO	LUMEN	CCT	FINITURA	CODICE	€
11 W	36°	1000 lm	2700 K	Nero	285436	47
11 W	36°	1100 lm	3000 K	Bianco	192406	47
11 W	36°	1100 lm	3000 K	Nero	192383	47

IP65

POTENZA	ANGOLO	LUMEN	CCT	FINITURA	CODICE	€
11 W	36°	1100 lm	3000 K	Bianco	313207	75
11 W	36°	1100 lm	3000 K	Nero	327761	75

DIMMABLE DRIVER* (NON INCLUSO/OPTIONAL)

	POTENZA	OUTPUT	MISURE	CODICE	€
1-10V/Push	20 W	250 mA	111 x 22 x 52 mm	217253	60
DALI/Push	12 W	250 mA	132 x 20 x 30 mm	202396	60

*Gli alimentatori dimmerabili devono essere ordinati contestualmente al prodotto e verranno già inclusi all'interno degli apparecchi in sostituzione degli alimentatori on-off.

GAME TRIMLESS

DA INCASSO

□ IP20 UGR:<19 CRI:≥80 DURATA LED: 50.000 h

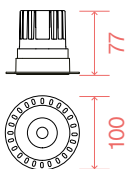

① 75

0,300 Kg
0,0011 m³

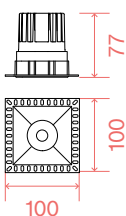

① 75x75

0,300 Kg
0,0011 m³

LED COB CREE (DRIVER ON/OFF INCLUSO - CRI ≥80)

POTENZA	ANGOLO	LUMEN	CCT	FINITURA	CODICE	€
11 W	36°	1100 lm	3000 K	Bianco	319667	50
11 W	36°	1100 lm	3000 K	Nero	319650	50

LED COB CREE (DRIVER ON/OFF INCLUSO - CRI ≥80)

POTENZA	ANGOLO	LUMEN	CCT	FINITURA	CODICE	€
11 W	36°	1100 lm	3000 K	Bianco	319681	50
11 W	36°	1100 lm	3000 K	Nero	319674	50

DIMMABLE DRIVER* (NON INCLUSO/OPTIONAL)

	POTENZA	OUTPUT	MISURE	CODICE	€
1-10V/Push	20 W	250 mA	111 x 22 x 52 mm	217253	60
DALI/Push	12 W	250 mA	132 x 20 x 30 mm	202396	60

*Gli alimentatori dimmerabili devono essere ordinati contestualmente al prodotto e verranno già inclusi all'interno degli apparecchi in sostituzione degli alimentatori on-off.

LIKA TRIM

DA INCASSO

□ IP20 UGR:<16 CRI: ≥90 DURATA LED: 50.000 h

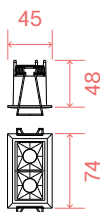

□ 68x37

0,130 Kg
0,0005 m³

LED SMD OSRAM (DRIVER ON/OFF INCLUSO)

POTENZA	ANGOLO	LUMEN	CCT	FINITURA	CODICE	€
6 W	29°	480 lm	3000 K	Bianco + Nero	206196	45
6 W	29°	520 lm	4000 K	Bianco + Nero	267869	45

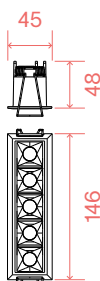

□ 140x37

0,320 Kg
0,0013 m³

LED SMD OSRAM (DRIVER ON/OFF INCLUSO)

POTENZA	ANGOLO	LUMEN	CCT	FINITURA	CODICE	€
12 W	29°	1200 lm	3000 K	Bianco + Nero	206219	65
12 W	29°	1250 lm	4000 K	Bianco + Nero	267876	65

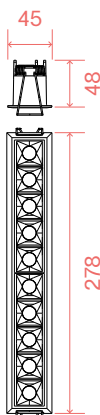

□ 273x37

0,480 Kg
0,0016 m³

LED SMD OSRAM (DRIVER ON/OFF INCLUSO)

POTENZA	ANGOLO	LUMEN	CCT	FINITURA	CODICE	€
20 W	29°	1750 lm	3000 K	Bianco + Nero	206233	110
20 W	29°	1850 lm	4000 K	Bianco + Nero	267883	110

DIMMABLE DRIVER* (NON INCLUSO/OPTIONAL)

MODELLO	CONTROLLO	POTENZA	OUTPUT	MISURE	CODICE	€
Lika 6 W	DALI	10 W	700 mA	132 x 20 x 30 mm	267982	56
Lika 12 W	DALI	12 W	700 mA	135 x 24 x 72 mm	267999	56
Lika 20 W	DALI/Push	25 W	600 mA	135 x 24 x 72 mm	268002	104

* Gli alimentatori dimmerabili devono essere ordinati contestualmente al prodotto e verranno già inclusi all'interno degli apparecchi in sostituzione degli alimentatori on-off.

LIKA TRIMLESS

DA INCASSO



IP20 UGR:<16 CRI:≥90 DURATA LED: 50.000 h

↑ FOTO p. 364

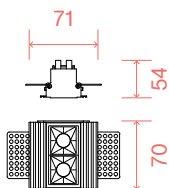

75x70

0,220 Kg
0,0005 m³

LED SMD OSRAM (DRIVER ON/OFF INCLUSO)

POTENZA	ANGOLO	LUMEN	CCT	FINITURA	CODICE	€
6 W	29°	480 lm	3000 K	Nero	206202	60
6 W	29°	520 lm	4000 K	Nero	267890	60

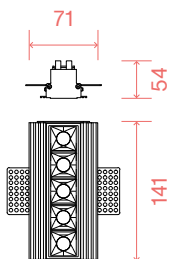

145x70

0,390 Kg
0,0013 m³

LED SMD OSRAM (DRIVER ON/OFF INCLUSO)

POTENZA	ANGOLO	LUMEN	CCT	FINITURA	CODICE	€
12 W	29°	1200 lm	3000 K	Nero	206226	95
12 W	29°	1250 lm	4000 K	Nero	267906	95

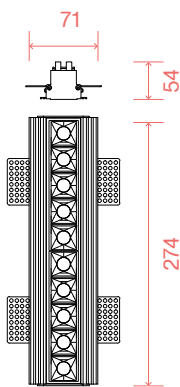

278x70

0,720 Kg
0,0023 m³

LED SMD OSRAM (DRIVER ON/OFF INCLUSO)

POTENZA	ANGOLO	LUMEN	CCT	FINITURA	CODICE	€
20 W	29°	1750 lm	3000 K	Nero	206240	151
20 W	29°	1850 lm	4000 K	Nero	267913	151

DIMMABLE DRIVER* (NON INCLUSO/OPTIONAL)

MODELLO	CONTROLLO	POTENZA	OUTPUT	MISURE	CODICE	€
Lika 6 W	DALI	10 W	700 mA	132 x 20 x 30 mm	267982	56
Lika 12 W	DALI	12 W	700 mA	135 x 24 x 72 mm	267999	56
Lika 20 W	DALI/Push	25 W	600 mA	135 x 24 x 72 mm	268002	104

* Gli alimentatori dimmerabili devono essere ordinati contestualmente al prodotto e verranno già inclusi all'interno degli apparecchi in sostituzione degli alimentatori on-off.

LIKA SLIM

DA INCASSO



IP20 UGR:<19 CRI: ≥90 DURATA LED: 30.000 h

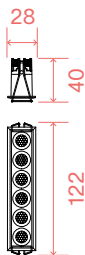

117x23

0,180 Kg
0,0013 m³

LED SMD (DRIVER ON/OFF INCLUSO)

POTENZA	ANGOLO	LUMEN	CCT	FINITURA	CODICE	€
10 W	32°	1000 lm	3000 K	Bianco	327501	65
10 W	32°	1000 lm	3000 K	Nero	305813	65

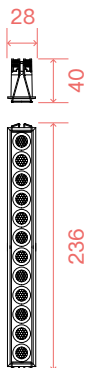

231x23

0,300 Kg
0,0022 m³

LED SMD (DRIVER ON/OFF INCLUSO)

POTENZA	ANGOLO	LUMEN	CCT	FINITURA	CODICE	€
19 W	32°	2000 lm	3000 K	Bianco	327518	110
19 W	32°	2000 lm	3000 K	Nero	305837	110

LINK TRIMLESS ON/OFF

BINARI

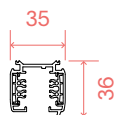
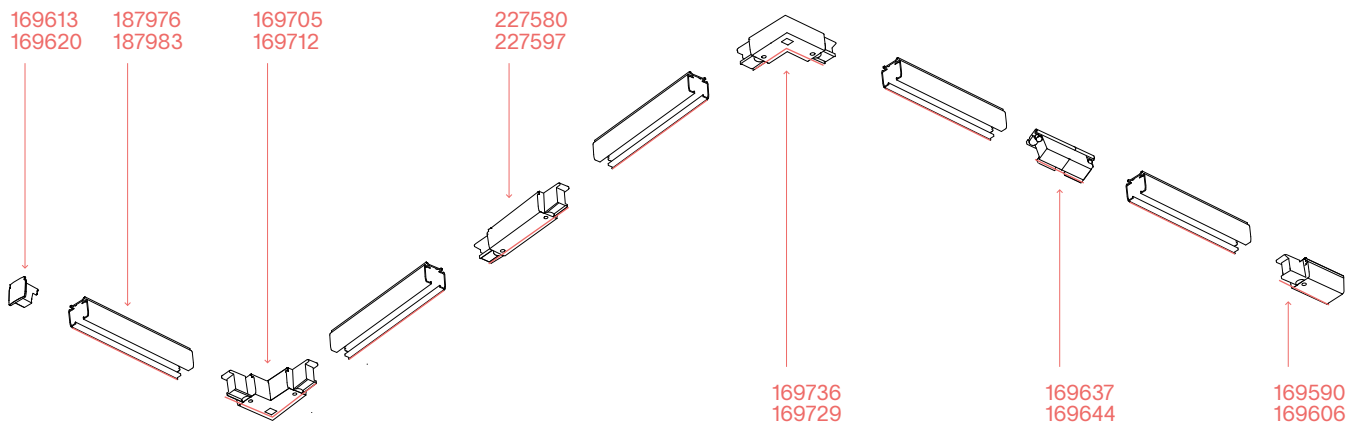

TRACK

LUNGHEZZA	PESO	VOLUME	FINITURA	CODICE	€
1000 mm	0,94 Kg	0,0016 m ³	Bianco	243269	35
1000 mm	0,94 Kg	0,0016 m ³	Nero	243252	35
2000 mm	1,72 Kg	0,0074 m ³	Bianco	187976	65
2000 mm	1,72 Kg	0,0074 m ³	Nero	187983	65
3000 mm	2,55 Kg	0,0110 m ³	Bianco	187990	105
3000 mm	2,55 Kg	0,0110 m ³	Nero	188003	105

	NECESSARIO	N° CAVI	LUNGHEZZA CAVI	FINITURA	CODICE	€
KIT SURFACE	SI - 1 Kit x 1000 mm			Bianco	169972	7
KIT SURFACE	SI - 1 Kit x 1000 mm			Nero	169989	7
SUSPENSION KIT	SI - 1 Kit x 1000 mm	1	3000 mm	Bianco	242705	16
SUSPENSION KIT	SI - 1 Kit x 1000 mm	1	3000 mm	Nero	243283	16
SUSPENSION KIT	SI - 1 Kit x 1000 mm	1	5000 mm	Bianco	243245	18
SUSPENSION KIT	SI - 1 Kit x 1000 mm	1	5000 mm	Nero	243238	18
END CAP	SI			Bianco	169613	4
END CAP	SI			Nero	169620	4

LINK TRIMLESS ON/OFF

BINARI

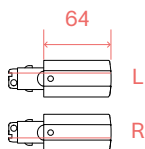

MAIN CONNECTOR END

LATO	FINITURA	CODICE	€
L	Bianco	169583	16
L	Nero	169576	16
R	Bianco	169590	16
R	Nero	169606	16

0,060 Kg
0,0002 m³

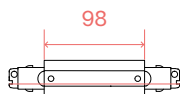

MAIN CONNECTOR MIDDLE

FINITURA	CODICE	€
Bianco	227580	26
Nero	227597	26

0,120 Kg
0,0004 m³

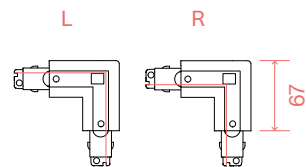

MAIN CONNECTOR CORNER

LATO	FINITURA	CODICE	€
L	Bianco	169705	27
L	Nero	169712	27
R	Bianco	169736	27
R	Nero	169729	27

0,110 Kg
0,0005 m³

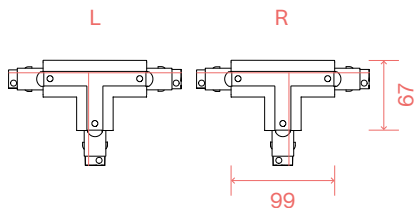

MAIN CONNECTOR T

LATO	FINITURA	CODICE	€
L	Bianco	324289	45
L	Nero	324272	45
R	Bianco	324302	45
R	Nero	324296	45

0,190 Kg
0,0005 m³

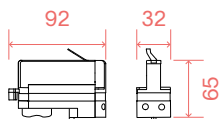

TRACK ADAPTOR

FINITURA	CODICE	€
Bianco	194257	12
Nero	194301	12

0,080 Kg
0,0002 m³

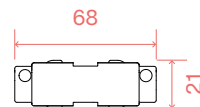

ELECTRIFIED CONNECTOR

FINITURA	CODICE	€
Bianco	169637	8
Nero	169644	8

0,030 Kg
0,0001 m³

LINK TRIMLESS DALI - 1-10V

BINARI

IP20

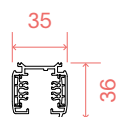
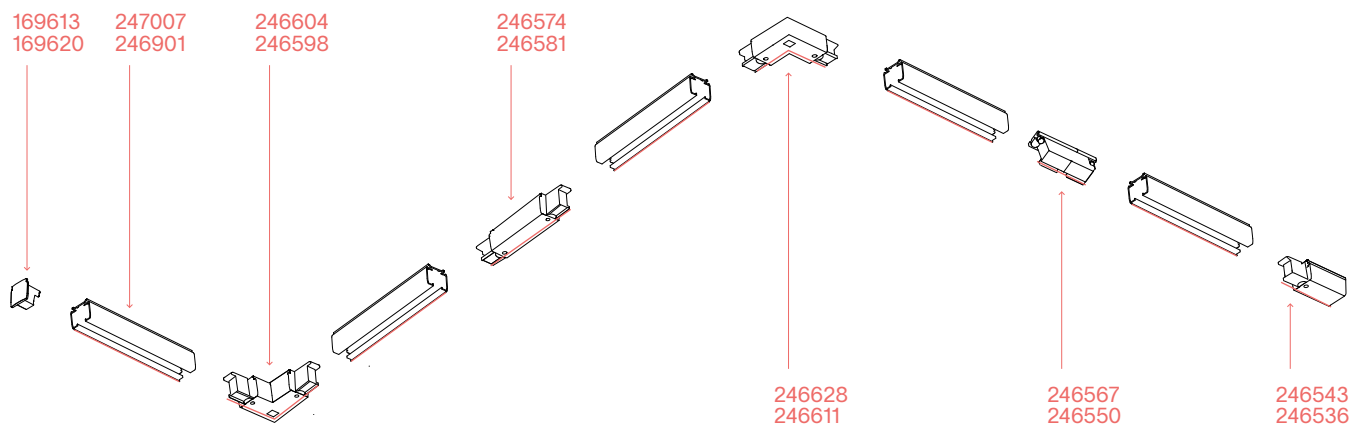

TRACK

LUNGHEZZA	PESO	VOLUME	FINITURA	CODICE	€
1000 mm	0,94 Kg	0,0016 m ³	Bianco	246468	38
1000 mm	0,94 Kg	0,0016 m ³	Nero	246451	38
2000 mm	1,93 Kg	0,0032 m ³	Bianco	247007	75
2000 mm	1,93 Kg	0,0032 m ³	Nero	246901	75
3000 mm	2,87 Kg	0,0048 m ³	Bianco	247625	115
3000 mm	2,87 Kg	0,0048 m ³	Nero	247618	115

	NECESSARIO	N° CAVI	LUNGHEZZA CAVI	FINITURA	CODICE	€
KIT SURFACE	SI - 1 Kit x 1000 mm			Bianco	169972	7
KIT SURFACE	SI - 1 Kit x 1000 mm			Nero	169989	7
SUSPENSION KIT	SI - 1 Kit x 1000 mm	1	3000 mm	Bianco	242705	16
SUSPENSION KIT	SI - 1 Kit x 1000 mm	1	3000 mm	Nero	243283	16
SUSPENSION KIT	SI - 1 Kit x 1000 mm	1	5000 mm	Bianco	243245	18
SUSPENSION KIT	SI - 1 Kit x 1000 mm	1	5000 mm	Nero	243238	18
END CAP	SI			Bianco	169613	4
END CAP	SI			Nero	169620	4

LINK TRIMLESS DALI - 1-10V

BINARI

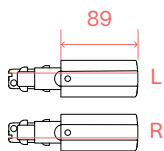

MAIN CONNECTOR END

LATO	FINITURA	CODICE	€
L	Bianco	246529	19
L	Nero	246512	19
R	Bianco	246543	19
R	Nero	246536	19

0,079 Kg
0,0002 m³

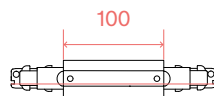

MAIN CONNECTOR MIDDLE

FINITURA	CODICE	€
Bianco	246581	31
Nero	246574	31

0,129 Kg
0,0004 m³

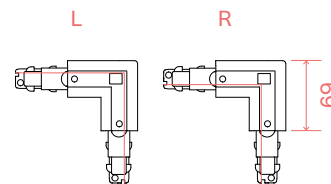

MAIN CONNECTOR CORNER

LATO	FINITURA	CODICE	€
L	Bianco	246604	33
L	Nero	246598	33
R	Bianco	246628	33
R	Nero	246611	33

0,130 Kg
0,0006 m³

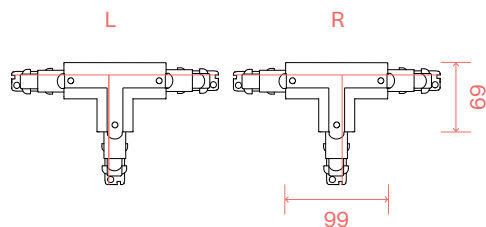

MAIN CONNECTOR T

LATO	FINITURA	CODICE	€
L	Bianco	324326	60
L	Nero	324319	60
R	Bianco	324340	60
R	Nero	324333	60

0,200 Kg
0,0007 m³

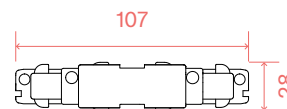

ELECTRIFIED CONNECTOR

FINITURA	CODICE	€
Bianco	246567	12
Nero	246550	12

0,050 Kg
0,0001 m³

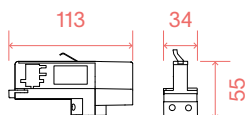

TRACK ADAPTOR

FINITURA	CODICE	€
Bianco	246505	20
Nero	246499	20

0,063 Kg
0,0003 m³

LINK TRIM ON/OFF

BINARI

IP20

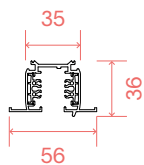
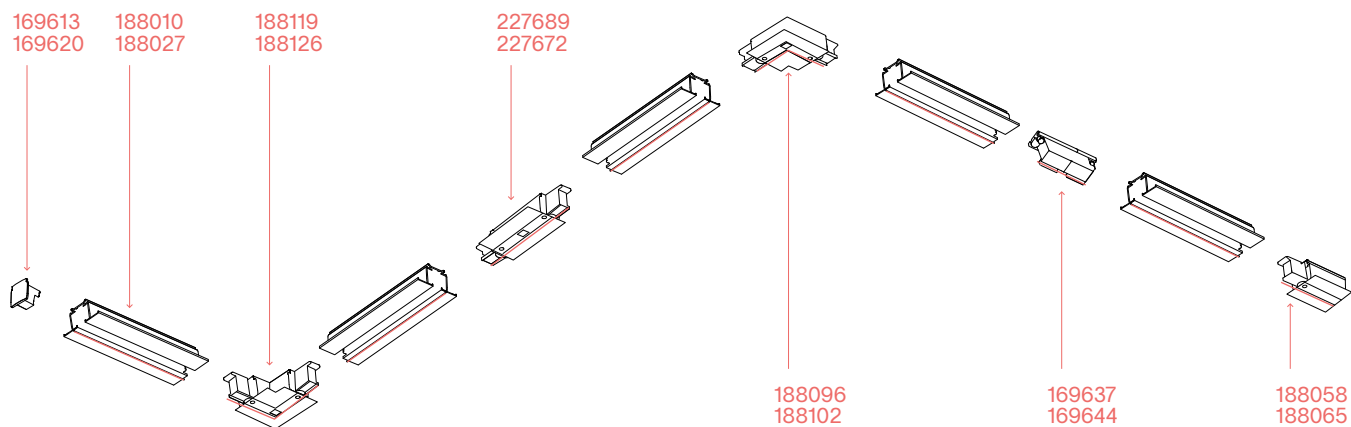

TRACK

LUNGHEZZA	PESO	VOLUME	FINITURA	CODICE	€
2000 mm	1,92 Kg	0,0132 m ³	Bianco	188010	68
2000 mm	1,92 Kg	0,0132 m ³	Nero	188027	68

	NECESSARIO	FINITURA	CODICE	€
KIT RECESSED	SI - 1 Kit x 1000 mm	Alluminio	188195	6
END CAP	SI	Bianco	169613	4
END CAP	SI	Nero	169620	4

LINK TRIM ON/OFF

BINARI

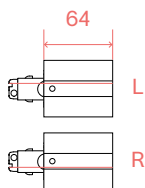

MAIN CONNECTOR END

LATO	FINITURA	CODICE	€
L	Bianco	188072	18
L	Nero	188089	18
R	Bianco	188058	18
R	Nero	188065	18

0,070 Kg
0,0002 m³

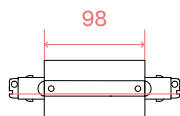

MAIN CONNECTOR MIDDLE

FINITURA	CODICE	€
Bianco	227689	29
Nero	227672	29

0,130 Kg
0,0004 m³

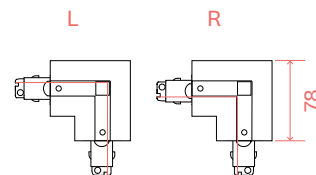

MAIN CONNECTOR CORNER

LATO	FINITURA	CODICE	€
L	Bianco	188119	30
L	Nero	188126	30
R	Bianco	188096	30
R	Nero	188102	30

0,120 Kg
0,0006 m³

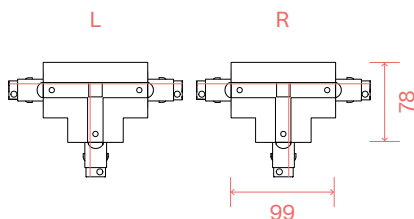

MAIN CONNECTOR T

LATO	FINITURA	CODICE	€
L	Bianco	324364	48
L	Nero	324357	48
R	Bianco	324388	48
R	Nero	324371	48

0,200 Kg
0,0051 m³

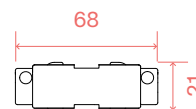

ELECTRIFIED CONNECTOR

FINITURA	CODICE	€
Bianco	169637	8
Nero	169644	8

0,030 Kg
0,0001 m³

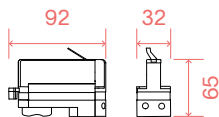

TRACK ADAPTOR

FINITURA	CODICE	€
Bianco	194257	12
Nero	194301	12

0,080 Kg
0,0002 m³

LINK TRIM DALI - 1-10V

BINARI

IP20

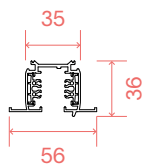
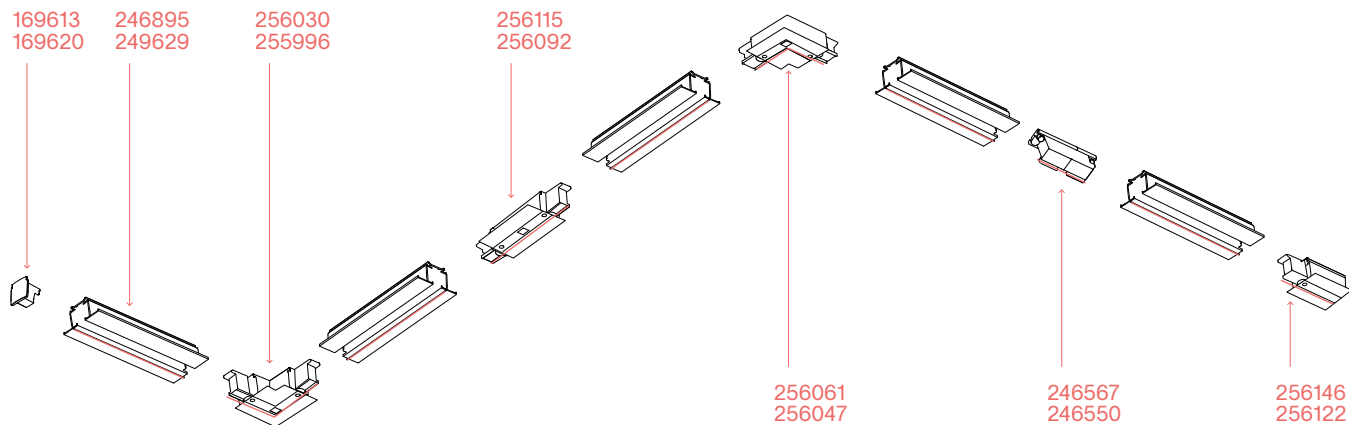

TRACK

LUNGHEZZA	PESO	VOLUME	FINITURA	CODICE	€
2000 mm	2,11 Kg	0,0048 m ³	Bianco	246895	76
2000 mm	2,11 Kg	0,0048 m ³	Nero	249629	76

	NECESSARIO	FINITURA	CODICE	€
KIT RECESSED	SI - 1 Kit x 1000 mm	Alluminio	188195	6
END CAP	SI	Bianco	169613	4
END CAP	SI	Nero	169620	4

LINK TRIM DALI - 1-10V

BINARI

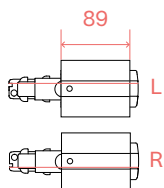

MAIN CONNECTOR END

LATO	FINITURA	CODICE	€
L	Bianco	256085	21
L	Nero	256078	21
R	Bianco	256146	21
R	Nero	256122	21

0,089 Kg
0,0004 m³

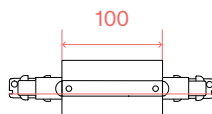

MAIN CONNECTOR MIDDLE

FINITURA	CODICE	€
Bianco	256115	34
Nero	256092	34

0,150 Kg
0,0005 m³

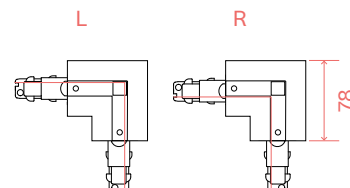

MAIN CONNECTOR CORNER

LATO	FINITURA	CODICE	€
L	Bianco	256030	36
L	Nero	255996	36
R	Bianco	256061	36
R	Nero	256047	36

0,150 Kg
0,0006 m³

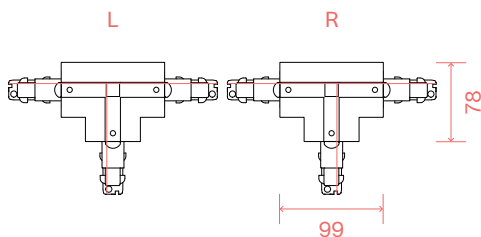

MAIN CONNECTOR T

LATO	FINITURA	CODICE	€
L	Bianco	324401	63
L	Nero	324395	63
R	Bianco	324425	63
R	Nero	324418	63

0,200 Kg
0,0051 m³

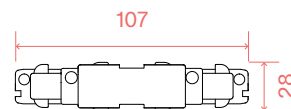

ELECTRIFIED CONNECTOR

FINITURA	CODICE	€
Bianco	246567	12
Nero	246550	12

0,050 Kg
0,0001 m³

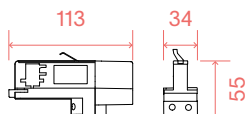

TRACK ADAPTOR

FINITURA	CODICE	€
Bianco	246505	20
Nero	246499	20

0,063 Kg
0,0003 m³



2,550 Kg
0,0158 m³
Lunghezza cavo
1500 mm

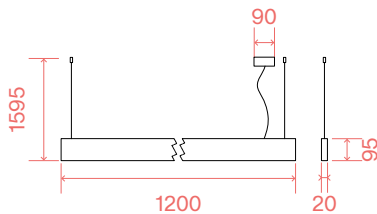

LED SMD (UP-LIGHT INCLUSA - DRIVER 1-10V INCLUSO)

POTENZA	ANGOLO	LUMEN	CCT	FINITURA	CODICE	€
32 W	104°	3450 lm	3000 K	Bianco	241968	220
32 W	104°	3450 lm	3000 K	Nero	241975	220
32 W	104°	3600 lm	4000 K	Bianco	268231	220
32 W	104°	3600 lm	4000 K	Nero	268217	220

UP-LIGHT INFO

POTENZA	ANGOLO	LUMEN	CCT
32 W	104°	3450 lm	3000 K
32 W	104°	3600 lm	4000 K

CORNER (OPTIONAL - UP-LIGHT NON INCLUSA)

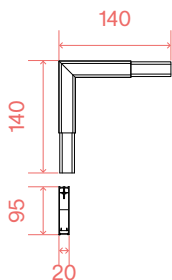

POTENZA	ANGOLO	LUMEN	CCT	FINITURA	CODICE	€
4 W	104°	430 lm	3000 K	Bianco	241999	46
4 W	104°	430 lm	3000 K	Nero	242002	46
4 W	104°	450 lm	4000 K	Bianco	268149	46
4 W	104°	450 lm	4000 K	Nero	268118	46

STRUCTURE CONNECTOR

0,260 Kg
0,0023 m³

NECESSARIO	CODICE	€
SI - 1 Kit x giunzione	241982	6

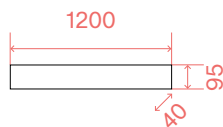

1,250 Kg
0,0158 m³
LED 32W
3450/3600 lm

FINITURA	LUMEN	CODICE	€
Bianco	3000K	233840	210
Bianco	4000K	268095	210
Nero	3000K	242019	210
Nero	4000K	268071	210

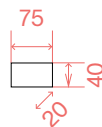

CONNECTOR
(NON INCLUSO
OPTIONAL)
cod. 233666, € 6



NOVA

DA INCASSO



IP20 CRI: ≥90 DURATA LED: 50.000 h FOTO p. 368

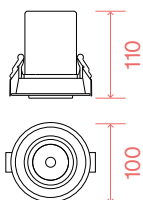

① 90

0,550 Kg
0,0016 m³

LED COB PHILIPS (DRIVER ON/OFF INCLUSO - UGR <19)

POTENZA	ANGOLO	LUMEN	CCT	FINITURA	CODICE	€
12 W	38°	1000 lm	3000 K	Bianco	248165	75
12 W	38°	1000 lm	3000 K	Nero	248189	75
12 W	38°	1100 lm	4000 K	Bianco	267937	75
12 W	38°	1100 lm	4000 K	Nero	267920	75

DIMMABLE DRIVER* (NON INCLUSO/OPTIONAL)

	POTENZA	OUTPUT	MISURE	CODICE	€
1-10V / Push	15 W	300 mA	111 x 22 x 52 mm	243993	60
DALI/ Push	12 W	300 mA	132 x 20 x 30 mm	243986	60

* Gli alimentatori dimmerabili devono essere ordinati contestualmente al prodotto e verranno già inclusi all'interno degli apparecchi in sostituzione degli alimentatori on-off.

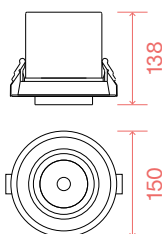

① 140

1,160 Kg
0,0039 m³

LED COB PHILIPS (DRIVER ON/OFF INCLUSO - UGR <22)

POTENZA	ANGOLO	LUMEN	CCT	FINITURA	CODICE	€
30 W	38°	3000 lm	3000 K	Bianco	248172	125
30 W	38°	3000 lm	3000 K	Nero	248196	125
30 W	38°	3250 lm	4000 K	Bianco	267951	125
30 W	38°	3250 lm	4000 K	Nero	267944	125

DIMMABLE DRIVER* (NON INCLUSO/OPTIONAL)

	POTENZA	OUTPUT	MISURE	CODICE	€
1-10V / Push	36 W	700 mA	167 x 32 x 41 mm	248370	110
DALI/ Push	36 W	700 mA	135 x 24 x 72 mm	248592	110

* Gli alimentatori dimmerabili devono essere ordinati contestualmente al prodotto e verranno già inclusi all'interno degli apparecchi in sostituzione degli alimentatori on-off.

	MODELLO	NECESSARIO	ANGOLO	CODICE	€
LENS	Nova 12W	NO	15°	244013	6
LENS	Nova 30W	NO	15°	248608	12

QUICK 15W

PROIETTORI



IP20

MacAdam: SDCM 3

CRI: ≥ 80 / ≥ 90

DURATA LED: 50.000 h

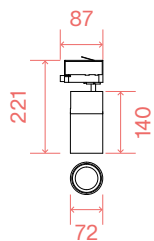

0,760 Kg
0,0038 m³

LED COB CITIZEN

CRI ≥ 80

POTENZA	ANGOLO	LUMEN	CCT	FINITURA	CODICE	€
15 W	30°	1800 lm	3000 K	Bianco	222509	145
15 W	30°	1800 lm	3000 K	Nero	222523	145
15 W	30°	1950 lm	4000 K	Bianco	222530	145
15 W	30°	1950 lm	4000 K	Nero	222547	145

CRI ≥ 90

POTENZA	ANGOLO	LUMEN	CCT	FINITURA	CODICE	€
15 W	30°	1550 lm	3000 K	Bianco	222554	145
15 W	30°	1550 lm	3000 K	Nero	222561	145
15 W	30°	1700 lm	4000 K	Bianco	222578	145
15 W	30°	1700 lm	4000 K	Nero	222585	145

	NECESSARIO	ANGOLO	FINITURA	CODICE	€
FILTER HONEYCOMB	NO		Nero	222608	9
LENS*	NO	15°	Trasparente	222592	9
LENS*	NO	45°	Trasparente	253558	9
SINGLE CONNECTION	NO		Bianco	170145	27
SINGLE CONNECTION	NO		Nero	170152	27

*La lente deve essere ordinata contestualmente al prodotto e verrà montata nel prodotto al posto della lente standard inclusa.

QUICK 21W

PROIETTORI



IP20

MacAdam: SDCM 3

CRI: ≥ 80 / ≥ 90

DURATA LED: 50.000 h

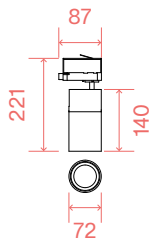

0,760 Kg
0,0038 m³

LED COB CITIZEN

CRI ≥ 80

POTENZA	ANGOLO	LUMEN	CCT	FINITURA	CODICE	€
21 W	30°	2450 lm	3000 K	Bianco	247946	155
21 W	30°	2450 lm	3000 K	Nero	247939	155
21 W	30°	2700 lm	4000 K	Bianco	247960	155
21 W	30°	2700 lm	4000 K	Nero	247953	155

CRI ≥ 90

POTENZA	ANGOLO	LUMEN	CCT	FINITURA	CODICE	€
21 W	30°	2150 lm	3000 K	Bianco	247977	155
21 W	30°	2150 lm	3000 K	Nero	225364	155
21 W	30°	2350 lm	4000 K	Bianco	247991	155
21 W	30°	2350 lm	4000 K	Nero	247984	155

	NECESSARIO	ANGOLO	FINITURA	CODICE	€
FILTER HONEYCOMB	NO		Nero	222608	9
LENS*	NO	15°	Trasparente	222592	9
LENS*	NO	45°	Trasparente	253558	9
SINGLE CONNECTION	NO		Bianco	170145	27
SINGLE CONNECTION	NO		Nero	170152	27

*La lente deve essere ordinata contestualmente al prodotto e verrà montata nel prodotto al posto della lente standard inclusa.

QUICK 28W

PROIETTORI



IP20

MacAdam: SDCM 3

CRI: ≥ 80 / ≥ 90

DURATA LED: 50.000 h



FOTO p. 340

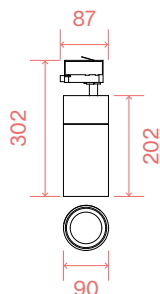

1,200 Kg
0,0063 m³

LED COB CITIZEN

CRI ≥ 80

POTENZA	ANGOLO	LUMEN	CCT	FINITURA	CODICE	€
28 W	30°	3550 lm	3000 K	Bianco	222615	185
28 W	30°	3550 lm	3000 K	Nero	222622	185
28 W	30°	3800 lm	4000 K	Bianco	222639	185
28 W	30°	3800 lm	4000 K	Nero	222646	185

CRI ≥ 90

POTENZA	ANGOLO	LUMEN	CCT	FINITURA	CODICE	€
28 W	30°	3100 lm	3000 K	Bianco	222653	185
28 W	30°	3100 lm	3000 K	Nero	222660	185
28 W	30°	3300 lm	4000 K	Bianco	222677	185
28 W	30°	3300 lm	4000 K	Nero	222684	185

	NECESSARIO	ANGOLO	FINITURA	CODICE	€
FILTER HONEYCOMB	NO		Nero	222714	10
LENS*	NO	18°	Trasparente	222691	10
LENS*	NO	45°	Trasparente	222707	10
SINGLE CONNECTION	NO		Bianco	170145	27
SINGLE CONNECTION	NO		Nero	170152	27

*La lente deve essere ordinata contestualmente al prodotto e verrà montata nel prodotto al posto della lente standard inclusa.



STRIP LED SUPPORT

LUNGHEZZA	PESO	VOLUME	FINITURA	CODICE	€
5000 mm	0,35 Kg	0,0234 m ³	Acciaio	258300	130
5000 mm	0,35 Kg	0,0234 m ³	Bianco	302256	130
5000 mm	0,35 Kg	0,0234 m ³	Nero	302263	130



LUNGHEZZA	PESO	VOLUME	FINITURA	CODICE	€
10000 mm	0,45 Kg	0,0029 m ³	Acciaio	302270	165
10000 mm	0,45 Kg	0,0029 m ³	Bianco	302287	165
10000 mm	0,45 Kg	0,0029 m ³	Nero	302294	165

RECOMMENDED STRIP LED AND DRIVER

STRIP LED (SMD 2835 120 LED/M CRI ≥90)

POTENZA	IP	LUMEN	CCT	LUNGHEZZA	CODICE	€
15 W/m	IP20	1400 lm/m	2700 K	5000 mm	272498	50
15 W/m	IP20	1450 lm/m	3000 K	5000 mm	272481	50
15 W/m	IP20	1600 lm/m	4000 K	5000 mm	272474	50
15 W/m	IP65	1400 lm/m	3000 K	5000 mm	272504	65
15 W/m	IP65	1480 lm/m	4000 K	5000 mm	287959	65

DRIVER (ON/OFF)

POTENZA	OUTPUT	CLASSE	MISURA (L X H X P)	DRIVER BOX	CODICE	€
30 W	24 Vdc	□	140 x 28 x 45 mm	255 x 55 x 75 mm	124070	17,50
60 W	24 Vdc	□	186 x 33 x 50 mm	255 x 55 x 75 mm	124087	30
150 W	24 Vdc	⊕	268 x 31 x 45 mm	330 x 60 x 80 mm	124117	50

VIRUS

DA INCASSO



IP20 CRI: ≥90 DURATA LED: 50.000 h

↑ FOTO p. 374

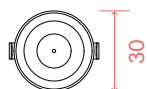
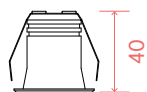

① 30

0,070 Kg
0,0003 m³

LED SMD OSRAM (DRIVER ON/OFF INCLUSO)

ESTERNO BIANCO

POTENZA	ANGOLO	LUMEN	CCT	FINITURA	CODICE	€
3 W	20°	210 lm	3000 K	Bianco	244808	32
3 W	20°	210 lm	3000 K	Oro	244822	32

LED SMD OSRAM (DRIVER ON/OFF INCLUSO)

ESTERNO NERO

POTENZA	ANGOLO	LUMEN	CCT	FINITURA	CODICE	€
3 W	20°	210 lm	3000 K	Nero	244846	32
3 W	20°	210 lm	3000 K	Oro	244853	32

AGOS

DA TERRA



IP54



FOTO p. 380

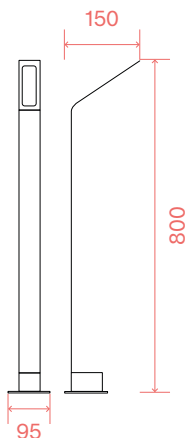

FINITURA	CCT	CODICE	€
Antracite	3000 K	254319	140
Antracite	4000 K	268422	140
Nero	3000 K	326733	140
Nero	4000 K	326757	140
Coffee	3000 K	326726	140
Coffee	4000 K	326740	140



Sorgente luminosa LED
3000/4000 K, 25.000 h
di durata.

1,100 Kg
0,0127 m³
LED 6,5W / 670/730 lm

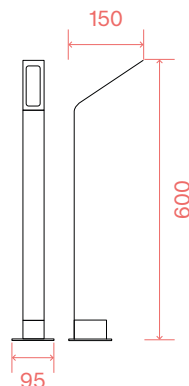

FINITURA	CCT	CODICE	€
Antracite	3000 K	254388	120
Antracite	4000 K	268439	120
Nero	3000 K	326696	120
Nero	4000 K	326719	120
Coffee	3000 K	326689	120
Coffee	4000 K	326702	120



Sorgente luminosa LED
3000/4000 K, 25.000 h
di durata.

0,950 Kg
0,0096 m³
LED 6,5W / 670/730 lm

ANDROMEDA

DA PARETE



IP55



FOTO p. 388

1,630 Kg
0,0052 m³
E27 max 2 x 60W



(CONSIGLIATA)

LUMEN	CCT	CODICE	€
600 lm	4000 K	151960	2

FINITURA	CODICE	€
Bianco	100364	85
Grigio	163543	85
Antracite	092355	85
Nero	100371	85
Coffee	163550	85

1,000 Kg
0,0039 m³
E27 max 1 x 60W

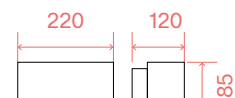

(CONSIGLIATA)

LUMEN	CCT	CODICE	€
600 lm	4000 K	151960	2

FINITURA	CODICE	€
Bianco	066868	55
Grigio	158822	55
Antracite	061580	55
Nero	061597	55
Coffee	163536	55

DJAMBE

DA TERRA



IP44



FOTO p. 392

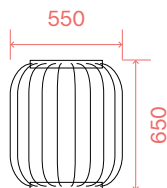

FINITURA	CODICE	€
Nero	293394	397
Coffee	293387	397



Sorgente luminosa LED
3000 K, 30.000 h di durata.

6,300 Kg
0,1884 m³
LED 18W / 2300 lm

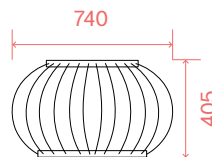

FINITURA	CODICE	€
Nero	293424	479
Coffee	293417	479



Sorgente luminosa LED
3000 K, 30.000 h di durata.

8,000 Kg
0,1654 m³
LED 18W / 2300 lm

GUN

DA PARETE



IP54



FOTO p. 400



IP44

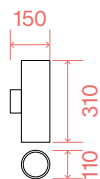

(CONSIGLIATA)

LUMEN	CCT	CODICE	€
600 lm	4000 K	151960	2

FINITURA	CODICE	€
Bianco	092300	72
Alluminio	033020	72
Grigio	163604	72
Antracite	236858	72
Nero	092317	72
Coffee	163611	72

1,350 Kg
0,0071 m³
E27 max 2 x 60W

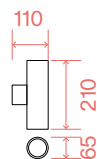

(CONSIGLIATA)

LUMEN	CCT	CODICE	€
430 lm	4000 K	253497	3

FINITURA	CODICE	€
Bianco	100388	65
Alluminio	033013	65
Grigio	163628	65
Antracite	236841	65
Nero	100395	65
Coffee	163635	65

0,720 Kg
0,0024 m³
GU10 max 2 x 35W

DA SOFFITTO



IP44

(CONSIGLIATA)

LUMEN	CCT	CODICE	€
430 lm	4000 K	253497	3

FINITURA	CODICE	€
Bianco	122663	54
Alluminio	092324	54
Grigio	163642	54
Antracite	236865	54
Nero	122687	54
Coffee	163666	54

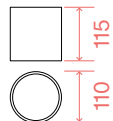

0,490 Kg
0,0030 m³
GU10 max 1 x 28W

IPOSTESI

DA TERRA



IP44



FOTO p. 408

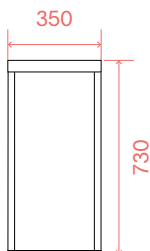

FINITURA	CODICE	€
Bianco	282244	335
Nero	282251	335

Sorgente luminosa LED
3000 K, 30.000 h di durata.

5,100 Kg
0,1041 m³
LED 16W / 1800 lm

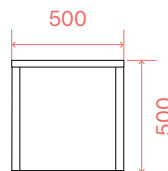

FINITURA	CODICE	€
Bianco	300641	435
Nero	300658	435

Sorgente luminosa LED
3000 K, 30.000 h di durata.

4,940 Kg
0,1379 m³
LED 16W / 1800 lm

JEDI

DA TERRA



IP65



FOTO p. 414

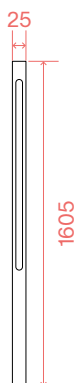

FINITURA	CODICE	€
Antracite	306803	135
Nero	293202	135

Sorgente luminosa LED
3000 K, 30.000 h di durata.

1,280 Kg
0,0065 m³
LED 25W / 2900 lm

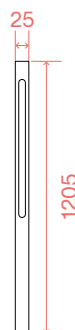

FINITURA	CODICE	€
Antracite	306797	110
Nero	293196	110

Sorgente luminosa LED
3000 K, 30.000 h di durata.

1,030 Kg
0,0150 m³
LED 19W / 2250 lm



Base
Non incluso
Optional

FINITURA	CODICE	€
Antracite	308227	10
Nero	308234	10

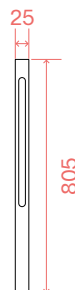

FINITURA	CODICE	€
Antracite	306780	80
Nero	293189	80

Sorgente luminosa LED
3000 K, 30.000 h di durata.

0,760 Kg
0,0036 m³
LED 12W / 1400 lm

LOLITA

DA TAVOLO



IP54



FOTO p. 420

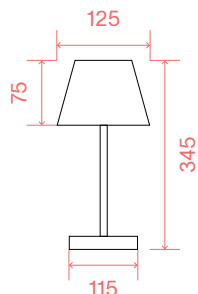

0,550 Kg
0,0078 m³
LED 2,8W / 250 lm

FINITURA	CODICE	€
Bianco	286723	55
Grigio	286730	55
Nero	286716	55
Coffee	286747	55

Sorgente luminosa LED
3000 K, 25.000 h di durata.

Durata 14 ore.



SIRIO

DA TERRA



IP44



FOTO p. 428

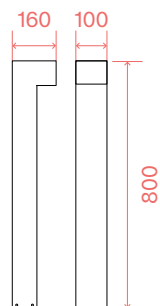

1,880 Kg
0,0181 m³
G9 max 2 x 15W

(CONSIGLIATA)

LUMEN	CCT	CODICE	€
530 lm	4000 K	307879	6

FINITURA	CODICE	€
Bianco	115085	165
Grigio	246963	165
Antracite	115061	165
Nero	115108	165
Coffee	213262	165

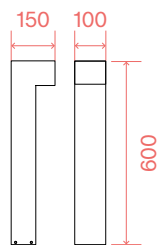

1,550 Kg
0,0136 m³
G9 max 2 x 15W

(CONSIGLIATA)

LUMEN	CCT	CODICE	€
530 lm	4000 K	307879	6

FINITURA	CODICE	€
Bianco	115092	130
Grigio	246970	130
Antracite	115078	130
Nero	115115	130
Coffee	213279	130

SOLE

SOSPENSIONE



IP44

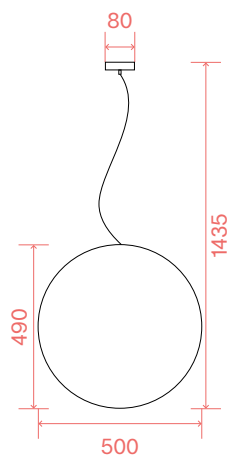

(CONSIGLIATA)

LUMEN	CCT	CODICE	€
1000 lm	4000 K	151991	2

FINITURA	CODICE	€
Bianco	136011	180

2,970 Kg
0,1327 m³
E27 max 1 x 60W

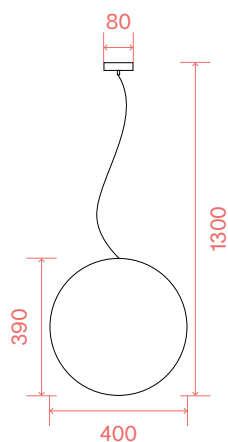

(CONSIGLIATA)

LUMEN	CCT	CODICE	€
1000 lm	4000 K	151991	2

FINITURA	CODICE	€
Bianco	136004	110

1,690 Kg
0,0776 m³
E27 max 1 x 60W

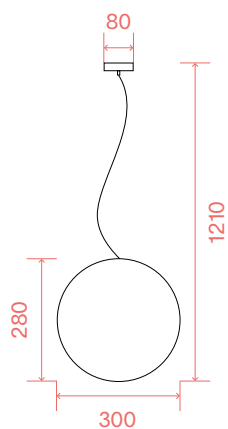

(CONSIGLIATA)

LUMEN	CCT	CODICE	€
1000 lm	4000 K	151991	2

FINITURA	CODICE	€
Bianco	135991	95

1,360 Kg
0,0338 m³
E27 max 1 x 60W

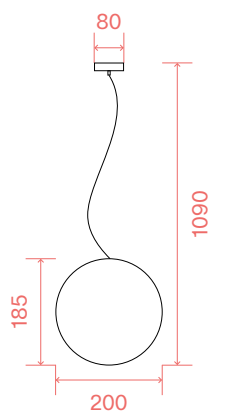

(CONSIGLIATA)

LUMEN	CCT	CODICE	€
600 lm	4000 K	151960	2

FINITURA	CODICE	€
Bianco	318837	90

1,300 Kg
0,0111 m³
E27 max 1 x 60W

SOLE

DA TERRA



IP44



FOTO p. 436

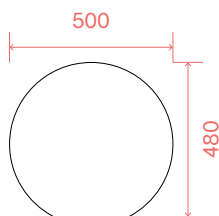

(CONSIGLIATA)

LUMEN	CCT	CODICE	€
1000 lm	4000 K	151991	2

FINITURA	CODICE	€
Bianco	191614	225

4,500 Kg
0,1460 m³
E27 max 1 x 60W

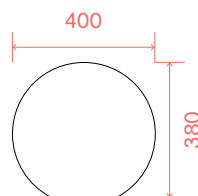

(CONSIGLIATA)

LUMEN	CCT	CODICE	€
1000 lm	4000 K	151991	2

FINITURA	CODICE	€
Bianco	191621	150

3,900 Kg
0,0741 m³
E27 max 1 x 60W

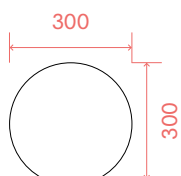

(CONSIGLIATA)

LUMEN	CCT	CODICE	€
1000 lm	4000 K	151991	2

FINITURA	CODICE	€
Bianco	191638	120

2,700 Kg
0,0322 m³
E27 max 1 x 60W

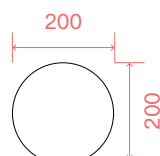

(CONSIGLIATA)

LUMEN	CCT	CODICE	€
600 lm	4000 K	151960	2

FINITURA	CODICE	€
Bianco	318820	110

1,200 Kg
0,0139 m³
E27 max 1 x 60W

STARLIGHT

PROIETTORE



MacAdam: SDCM 3 IP68 CRI: ≥80 DURATA LED: 50.000 h



FOTO p. 442

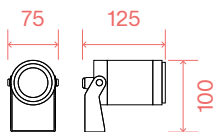

LED COB BRIDGELUX (DRIVER NON INCLUSO)

POTENZA	ANGOLO	LUMEN	CCT	FINITURA	CODICE	€
10 W	30°	1000 lm	3000 K	Grigio Scuro	248387	250
10 W	30°	1050 lm	4000 K	wwGrigio Scuro	245072	250

0,950 Kg
0,0014 m³

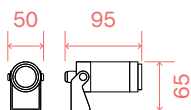

LED COB BRIDGELUX (DRIVER NON INCLUSO)

POTENZA	ANGOLO	LUMEN	CCT	FINITURA	CODICE	€
5,5 W	30°	600 lm	3000 K	Grigio Scuro	248394	120
5,5 W	30°	670 lm	4000 K	Grigio Scuro	245041	120

0,280 Kg
0,0005 m³

OPTIONAL (NON INCLUSO)

	POTENZA	FINITURA	CODICE	€
Visiera	5,5 W	Grigio Scuro	245096	34
Visiera	10 W	Grigio Scuro	245102	34
Connettore IP68		Nero	248615	22
Picchetto		Grigio Scuro	245089	17

ON/OFF DRIVER (NON INCLUSO/NECESSARIO)

OUTPUT	POTENZA	MISURA	CODICE	€
24 Vdc	20 W	118 x 26 x 35 mm	226187	75
24 Vdc	35 W	148 x 30 x 40 mm	226194	80
24 Vdc	100 W	220 x 39 x 68 mm	226200	190
24 Vdc	185 W	220 x 39 x 68 mm	226217	210

STYLE

DA PARETE

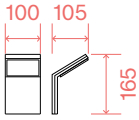

0,390 Kg
0,0018 m³
LED 9W
1050/1100 lm

FINITURA	CCT	CODICE	€
Bianco	3000 K	269139	135
Bianco	4000 K	221502	135
Grigio	3000 K	322650	135
Grigio	4000 K	322643	135
Antracite	3000 K	246857	135
Antracite	4000 K	209845	135
Nero	3000 K	322636	135
Nero	4000 K	322629	135
Coffee	3000 K	322704	135
Coffee	4000 K	322681	135

Sorgente luminosa LED
3000/4000 K, 30.000 h
di durata.

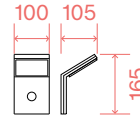

0,400 Kg
0,0018 m³
LED 9,5W
1050/1100 lm

FINITURA	CCT	CODICE	€
Bianco	3000 K	269146	165
Bianco	4000 K	209852	165
Antracite	3000 K	246864	165
Antracite	4000 K	221519	165

Sorgente luminosa LED
3000/4000 K, 30.000 h
di durata.



DA TERRA



FOTO p. 448

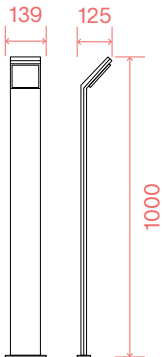

1,680 Kg
0,0239 m³
LED 9W
1050/1100 lm

FINITURA	CCT	CODICE	€
Bianco	3000 K	318707	190
Bianco	4000 K	322483	190
Grigio	3000 K	322384	190
Grigio	4000 K	322353	190
Antracite	3000 K	246871	190
Antracite	4000 K	209906	190
Nero	3000 K	322230	190
Nero	4000 K	322216	190
Coffee	3000 K	322452	190
Coffee	4000 K	322438	190

Sorgente luminosa LED
3000/4000 K, 30.000 h
di durata.

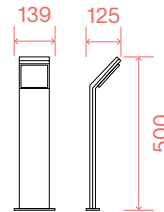

0,020 Kg
0,0122 m³
LED 9W
1050/1100 lm

FINITURA	CCT	CODICE	€
Bianco	3000 K	318691	145
Bianco	4000 K	322582	145
Grigio	3000 K	322551	145
Grigio	4000 K	322544	145
Antracite	3000 K	322612	145
Antracite	4000 K	322599	145
Nero	3000 K	322537	145
Nero	4000 K	322506	145
Coffee	3000 K	322575	145
Coffee	4000 K	322568	145

Sorgente luminosa LED
3000/4000 K, 30.000 h
di durata.

TAURUS ACCENT

DA INCASSO



IP67

CRI: ≥80

DURATA LED: 50.000 h



FOTO p. 454

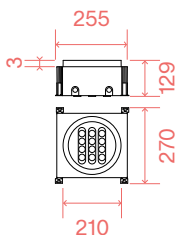

3,500 Kg
0,0242 m³

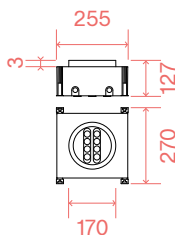

3,250 Kg
0,0133 m³

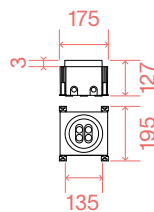

1,980 Kg
0,0071 m³

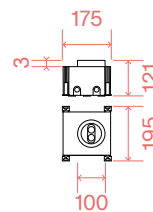

1,460 Kg
0,0129 m³

LED SMD OSRAM (DRIVER ON/OFF INCLUSO)

DIMENSIONI	POTENZA	LUMEN	CCT	FINITURA	CODICE	€
ø 210	20 W	1900 lm	3000 K	Acciaio	277035	530
ø 170	14 W	1300 lm	3000 K	Acciaio	277028	405
ø 135	11 W	840 lm	3000 K	Acciaio	277011	320
ø 100	6 W	420 lm	3000 K	Acciaio	277004	210

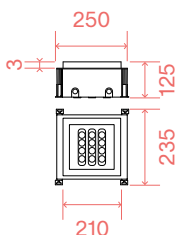

3,000 Kg
0,0168 m³

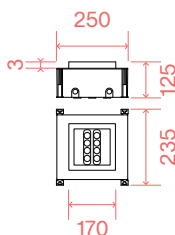

2,050 Kg
0,0141 m³

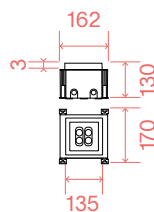

1,700 Kg
0,0080 m³

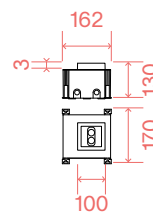

1,100 Kg
0,0067 m³

LED SMD OSRAM (DRIVER ON/OFF INCLUSO)

DIMENSIONI	POTENZA	LUMEN	CCT	FINITURA	CODICE	€
210	20 W	1900 lm	3000 K	Acciaio	325712	575
170	14 W	1300 lm	3000 K	Acciaio	325682	435
135	11 W	840 lm	3000 K	Acciaio	325651	355
100	6 W	420 lm	3000 K	Acciaio	325620	235

TAURUS WIDE

DA INCASSO



IP67 CRI: ≥80

DURATA LED: 50.000 h

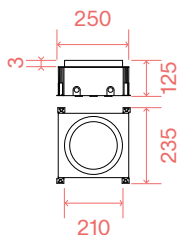

3,000 Kg
0,0183 m³

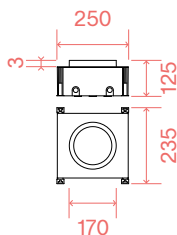

2,100 Kg
0,0137 m³

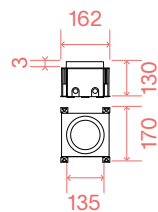

1,400 Kg
0,0091 m³

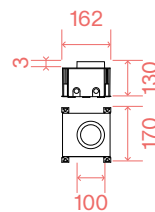

1,100 Kg
0,0077 m³

LED SMD BRIDGELUX (DRIVER ON/OFF INCLUSO)

DIMENSIONI	POTENZA	LUMEN	CCT	WTURA	CODICE	€
ø 210	21 W	2700 lm	3000 K	Acciaio	325729	420
ø 170	16 W	1750 lm	3000 K	Acciaio	325699	320
ø 135	11 W	1250 lm	3000 K	Acciaio	325668	275
ø 100	6 W	620 lm	3000 K	Acciaio	325637	195

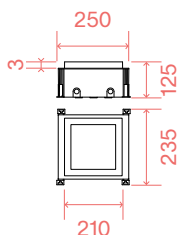

3,000 Kg
0,0168 m³

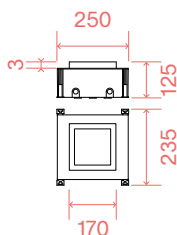

2,380 Kg
0,0141 m³

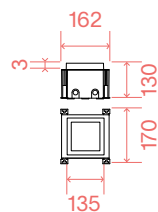

1,580 Kg
0,0080 m³

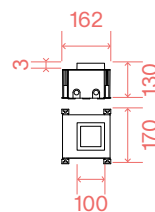

1,100 Kg
0,0067 m³

LED SMD BRIDGELUX (DRIVER ON/OFF INCLUSO)

DIMENSIONI	POTENZA	LUMEN	CCT	FINITURA	CODICE	€
210	21 W	2700 lm	3000 K	Acciaio	325736	450
170	16 W	1750 lm	3000 K	Acciaio	325705	340
135	11 W	1230 lm	3000 K	Acciaio	325675	285
100	6 W	620 lm	3000 K	Acciaio	325644	205

TECHO

DA SOFFITTO



IP54



FOTO p. 460

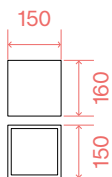

1,700 Kg
0,0049 m³
GU10 max 1 x 20W

(CONSIGLIATA)

LUMEN	CCT	CODICE	€
820 lm	4000 K	253398	15

FINITURA	CODICE	€
Bianco	251523	115
Grigio	326887	115
Antracite	251516	115
Nero	251530	115
Coffee	251547	115

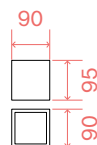

0,600 Kg
0,0012 m³
GU10 max 1 x 20W

(CONSIGLIATA)

LUMEN	CCT	CODICE	€
430 lm	4000 K	253497	3

FINITURA	CODICE	€
Bianco	251561	64
Grigio	326894	64
Antracite	251554	64
Nero	251578	64
Coffee	251592	64

TESLA

DA TERRA



IP44



FOTO p. 466



3,000 Kg
0,0379 m³
G9 max 4 x 15W

(CONSIGLIATA)

LUMEN	CCT	CODICE	€
530 lm	4000 K	307879	6

FINITURA	CODICE	€
Bianco	153179	155
Grigio	326931	155
Antracite	153162	155
Nero	316055	155
Coffee	326924	155

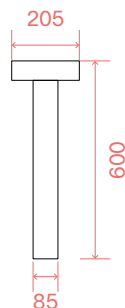

2,560 Kg
0,0273 m³
G9 max 4 x 15W

(CONSIGLIATA)

LUMEN	CCT	CODICE	€
530 lm	4000 K	307879	6

FINITURA	CODICE	€
Bianco	153209	145
Grigio	326900	145
Antracite	153193	145
Nero	326917	145
Coffee	316048	145

VEGA

DA TERRA



IP44



FOTO p. 472

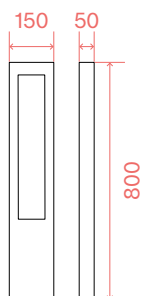

1,150 Kg
0,0092 m³
G9 max 1 x 15W

(CONSIGLIATA)

LUMEN	CCT	CODICE	€
530 lm	4000 K	307879	6

FINITURA	CODICE	€
Bianco	136035	180
Grigio	136042	180
Antracite	136028	180
Nero	136059	180
Coffee	213361	180

Icone tecniche



Classe I Sicurezza elettrica garantita dall'isolamento principale e da un conduttore di protezione (messa a terra) collegato alla struttura metallica della lampada. Messa a terra obbligatoria.



Classe III Sicurezza elettrica garantita dall'alimentazione a bassissima tensione (inferiore a 50 Volt). Non deve avere messa a terra.



Classe II Sicurezza elettrica garantita dall'isolamento principale e da un doppio isolamento o da un isolamento rinforzato. Non deve avere messa a terra.



Marchio di conformità alle direttive comunitarie europee di sicurezza.

Simboli



Articoli con lampade a LED: consumo estremamente ridotto, luce chiara e concentrata, robustezza e lunga durata.



Apparecchio fornito con variatore di potenza.



Interruttore integrato nel corpo luce.



Lampada con presa USB integrata.



Apparecchio dotato di interruttore touch: si accende e si regola l'intensità col tocco di un dito sul corpo luce.



Lampada con batteria ricaricabile inclusa.



Lampada con rilevazione di presenza inclusa PIR (Passive InfraRed).



Articolo in acciaio inox 316.



Prodotto ad alto contenuto tecnologico, elevata qualità dei materiali, destinato ad uso professionale.

NOTE:

- I prezzi indicati sono riferiti al pubblico IVA esclusa.

- Ideal lux s.r.l. si riserva il diritto di apportare, in qualunque momento e senza preavviso, tutte le modifiche necessarie a migliorare la qualità degli articoli illustrati nel presente catalogo. Per verificare le caratteristiche più aggiornate, consultare la documentazione nel sito web (www.ideal-lux.com).

- I nostri prodotti in classe I e II si alimentano con tensione nominale di 220-240 vac 50/60 hz. Tutti i nostri prodotti sono conformi alle direttive CE.

- Qualora acquistato separatamente come "optional", il driver dimmerabile sarà già incluso nel prodotto in sostituzione del driver standard on-off: verrà fornito un solo driver.

- I Watt indicati a catalogo esprimono la potenza NOMINALE dell'articolo comprensivo di sorgente

e driver, quando inclusi. I valori riferiti ai lm relativi alle lampade con sorgenti integrate a LED, sono da considerarsi NOMINALI, riferiti cioè alla sorgente. Per i lm effettivi dei singoli apparecchi illuminanti si prega gentilmente di consultare le fotometrie.

- Il valore UGR non è una caratteristica dell'apparecchio, ma dell'installazione. Gli UGR riportati in questo catalogo sono stati calcolati tenendo conto di un'installazione ideale e sono raggruppati nei blocchi <10 <13 <16 <19 <22.

Si consiglia di calcolare l'UGR specifico secondo la propria installazione.

- La durata di vita utile delle sorgenti LED di tutti gli articoli presenti a catalogo è riferita al valore L70B50, quando non dichiarato altrimenti.

Fotografia: Tiziano Sartorio - tizianosartorio.com

Setup & styling: Alessandro Pasinelli - alessandropasinelli.com

Art direction e progetto grafico: jekyll & hyde - jeh.it

Immagini: pag. 5, 7, 150, 286, 350, 378, Stocksy; pag. 120, iStock;
pag. 14, Shutterstock; pag. 196, DTS; pag. 236, 296, Unsplash.

Agos, Andromeda, Bean, Bento, Birds, Clip, Cover, Delta,
Diesis, Display, Djambe, Dorsale, Dot, Dynamite, Ego, Eos
Equinoxe, Essence, Fade, Filo, Fluo, Fly, Focus, Fox, Frame,
Futura, Game, Gemini, Gun, Ipotesi, Jedi, Lika, Link, Linus,
Lolita, Look, Mapa Bianco, Mint, Mix Up, Moby, Nemo, Nova,
Onion, Oracle Slim, Oz, Perlage, Piano, Pivot, Quick,
Set Up, Sirio, Sole, Spike, Starlight, Style, Taurus, Techo,
Tesi, Tesla, Ultrathin , Vega, Virus, Yoko, Zig Zag.