

Suspensions, Ceiling lamps, Wall lamps,
Table lamps, Floor lamps, Systems, Spotlights
and Tracks, Recessed lights, Outdoor lamps.
Selection for designers and architects.

Light is about moments.

ideal lux. selection

Ideal Lux s.r.l.

Headquarter

Via Taglio Destro, 32
30035 Mirano — Venezia
P.I. / C.F. 02420040277
8.00 - 12.00 / 13.30 - 17.30

Warehouse

Via delle Industrie, 8/D
30036 Santa Maria di Sala — Venezia
8.00 - 12.00 / 13.00 - 17.00

E info@ideal-lux.com

T +39 041 5790500

F +39 041 8872349

Ig: [ideal.lux](#)

Fb: [Ideal Lux](#)

www.ideal-lux.com

Copyright 2024 © IDEAL LUX S.r.l.

All rights reserved

Tutti i diritti sono riservati

This catalogue is a selection of our products designed for designers, architects, and lighting professionals. It has been conceived as a resource to guide you in your creative journey, offering inspiration and tools to quickly identify options that best suit your visions.

Our experience in balancing form and function is reflected in every product, offering lighting solutions that speak to both contemporary aesthetics and timeless functionality.

The Ideal Lux team is ready to accompany you on this journey.

Raffaele Strano, CEO

A handwritten signature in black ink, appearing to read 'Raffaele Strano', written in a cursive style.

Light offers warmth, shelter, comfort, intimacy. Ideal Lux celebrates it through its products, essential lighting fixtures. The challenge it faces every day is to unite the design of the products and the immateriality of light to create personalized and unique spaces which can tell the story of those who animate them.

Anyone involved in the design of living spaces can find in Ideal Lux the ideal partner to define areas capable of telling the lives of their clients, creating contexts in which everyone becomes the protagonist of their own story. Environments that best represent the personality and taste of those who inhabit them.

Light is a form of pure energy that brings joy and not only allows us to see but also influences our mood and well-being.

Attention to people is central, which is why every lighting system is designed to enhance every moment and every place, giving the opportunity to express what is important to each of us.

Nowadays, light is no longer just functional for illuminating a space but elevates it, fully expressing the essence that the designer has sought to impart through geometries and materials.

Every space, when infused with the right light, takes on a deeper, more authentic, and vital meaning, recounting the different moments of our daily lives.



LIGHT IS

ABOUT MOMENTS

IDEAL LUX

PRESENTATION

Since 1974, Ideal Lux has been passionately dedicated to creating lighting furnishing accessories capable of satisfying every need. The *Selection* collection gathers some of the more than 3700 products offered by the company, designed to embrace a modern and design-oriented taste.

LIGHT TALES

BOTH THE LIGHT
AND THE MOMENTS
CAN BE
FLEETING.
THE LIGHT
THAT DISAPPEARS
BY TURNING OFF
THE SWITCH,
THE MOMENTS
THAT PASS
IN THE BLINK
OF AN EYE.
ALL THIS
MAKES THEM
UNFORGETTABLE.

Attention and dedication to the customer are the very foundation of Ideal Lux. Our Customer Care represents a fundamental pillar within the company, with an emphasis on reliability as our core value. We place the needs of people at the top of our priorities.

For us, quality cannot exist without a warranty. We have extended the coverage to 5 years on all our lighting furnishing accessories, to ensure the highest standards in the products and services offered at all times.





WALL LAMPS
P. 142

SECTION INDEX

DATASHEETS
P. 481



TABLE LAMPS
P. 198

CEILING LAMPS
P. 112



SUSPENSIONS
P. 14



FLOOR LAMPS
P. 226



SECTION INDEX

DATASHEETS
P. 481



RECESSED LIGHTS
P. 340



SPOTLIGHTS AND TRACKS
P. 270



SYSTEMS
P. 270



OUTDOORS
P. 368

ALPHABETICAL
INDEXINDOORS → IN
OUTDOORS → OUT**AGOS** OUT
→ Floor 370**ANDROMEDA** OUT
→ Wall 378**ATOM** OUT
→ Wall 382**BEAN** IN
→ Wall 144**BINOMIO** IN
→ Wall 148
→ Ceiling 488**BIRDS** IN
→ Suspension 489
→ Ceiling 114
→ Wall 490
→ Table 490
→ Floor 228**CLIP** IN
→ Wall 152**COVER** IN
→ Wall 156**DELTA** IN
→ Wall 162**DEVA** IN
→ System 272**DIESIS** IN
→ Suspension 493
→ Table 493
→ Floor 234**DISPLAY** IN
→ Projectors 278**DORSALE** IN
→ Floor 242**DYNAMITE** IN
→ Suspension 495
→ Ceiling 118**EGO** IN
→ Floor 495
→ System 286**EOS** IN
→ Projectors 306**EQUINOXE** IN
→ Suspension 16
→ Wall 498
→ Floor 248**ESSENCE** IN
→ Suspension 498
→ Wall 168**FILO** IN
→ Suspension 20
→ Wall 500
→ Table 501
→ Floor 254**FLUO** IN
→ System 314**FLY** IN
→ Ceiling 124**FOCUS** IN
→ Wall 174**FOX** IN
→ Projectors 320**FRAME** IN
→ Suspension 24
→ Ceiling 130
→ Floor 507**FUTURA** IN
→ Table 200
→ Floor 508**GAME** IN
→ Recessed light 342**GEMINI** IN
→ Suspension 32
→ Ceiling 509**GUN** OUT
→ Ceiling 611
→ Wall 388**JEDI** OUT
→ Floor 396**LIKA** IN
→ Recessed light 348**LINK** IN
→ Track 588**LINEA** OUT
→ Wall 402**LINUS** IN
→ System 324
→ Wall 600**LOLITA** OUT
→ Table 406**LOOK** IN
→ Suspension 38
→ Ceiling 511
→ Wall 511
→ Floor 511
→ Track mounted 512

MAPA	IN	PERLAGE	IN	STARLIGHT	OUT
→ Suspension	46	→ Suspension	94	→ Projectors	436
→ Ceiling	514	→ Ceiling	526		
→ Wall	513	→ Wall	527	STYLE	OUT
→ Table	206	→ Table	527	→ Wall	618
		→ Floor	260	→ Floor	442
MINT	IN	PIANO	IN	SWIPE	OUT
→ Suspension	52	→ Wall	184	→ Wall	448
MIX UP	IN	PUNTO	OUT	TAURUS	OUT
→ Suspension	56	→ Wall	414	→ Recessed light	454
→ Ceiling	515				
→ Floor	516	PURE	OUT	TECHO	OUT
MOBY	IN	→ Floor	418	→ Ceiling	460
→ Suspension	68	→ Table	614		
NEMO	IN	QUICK	IN	TESI	IN
→ Suspension	74	→ Projectors	330	→ System	336
NINFEA	IN	SET UP	IN	TESLA	OUT
→ Ceiling	518	→ Suspension	528	→ Floor	466
→ Wall	178	→ Ceiling	528		
→ Table	518	→ Wall	188	ULTRATHIN	IN
NITRO	IN	→ Table	220	→ Suspension	106
→ Ceiling	134	→ Floor	266	VEGA	OUT
NOVA	IN	SIRIO	OUT	→ Floor	472
→ Recessed light	352	→ Wall	615	VIRUS	IN
ORACLE SLIM	IN	→ Floor	422	→ Recessed light	358
→ Suspension	80	→ Projectors	615		
→ Ceiling	523	SMARTIES	IN	ZEUS	IN
OZ	IN	→ Suspension	100	→ Recessed light	362
→ Suspension	88	→ Ceiling	532		
→ Ceiling	524	→ Wall	533	ZIG ZAG	IN
→ Wall	525	→ Table	533	→ Wall	192
→ Table	212	SOLE	OUT		
		→ Suspension	615		
		→ Floor	430		
		SPIKE	IN		
		→ Ceiling	138		
		→ Projectors	604		

SUSPENSIONS

LOVING GAZE,
MOIST EARTH,
WISE HANDS,
COOL WATER,
SHINING LEAVES,
VIBRANT LIGHT,
LIT LAMP,
FALLING DROPS,
LUSH PLANTS.





Index

↳

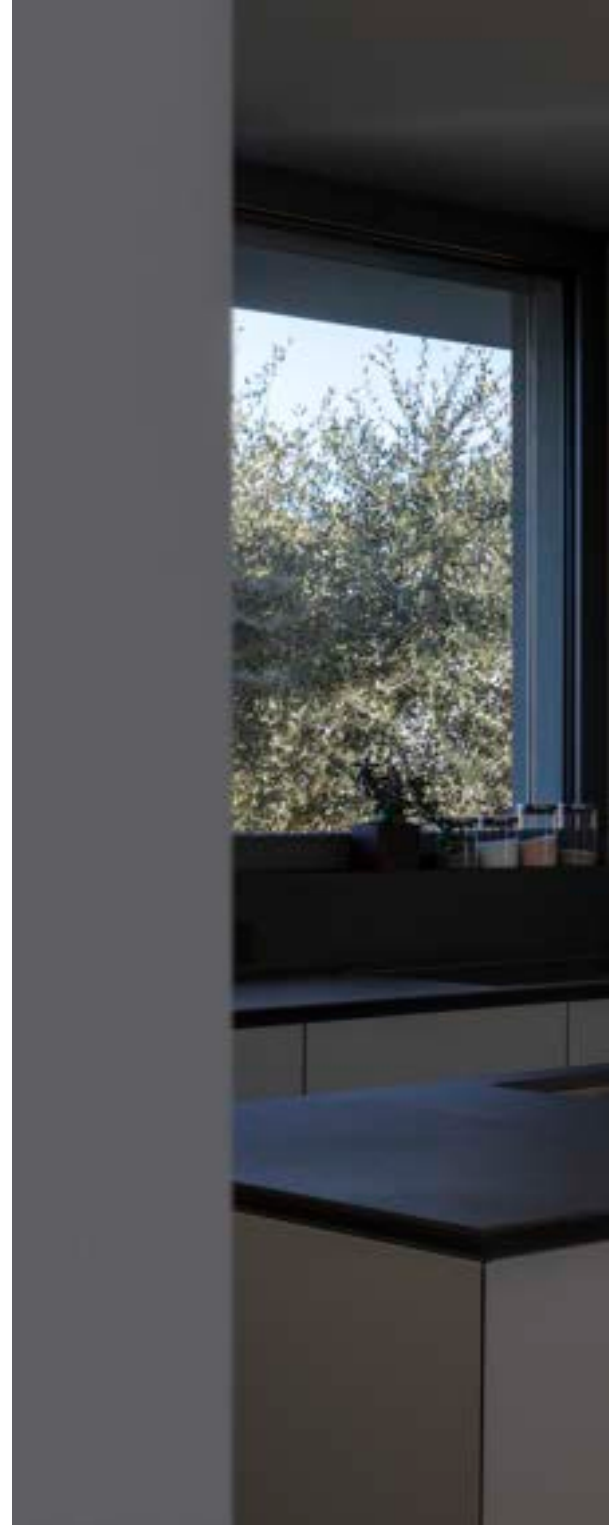
16	Equinoxe
20	Filo
24	Frame
32	Gemini
38	Look
46	Mapa
52	Mint
56	Mix Up
68	Moby
74	Nemo
80	Oracle Slim
88	Oz
94	Perlage
100	Smarties
106	Ultrathin

DATASHEETS ONLY	489	Birds
	493	Diesis
	495	Dynamite
	498	Essence
	528	Set Up



EQUINOXE

Plated metal structure. Clear borosilicate glass diffusers. Black PVC cable. Colors: chrome structure with clear or faded smoky glass, antique brass structure with clear glass or faded amber glass.









EQUINOXE

SUSPENSIONS INDOORS

IDEAL LUX



FILO

Powder coated or plated metal ceiling cap and bodies. Black PVC electric cables. Models 300801, 300818 and 300825 with 4 meters cable and switch on the ceiling cap. Colors: white, black or satin brass.







FILO

SUSPENSIONS

INDOORS

IDEAL LUX



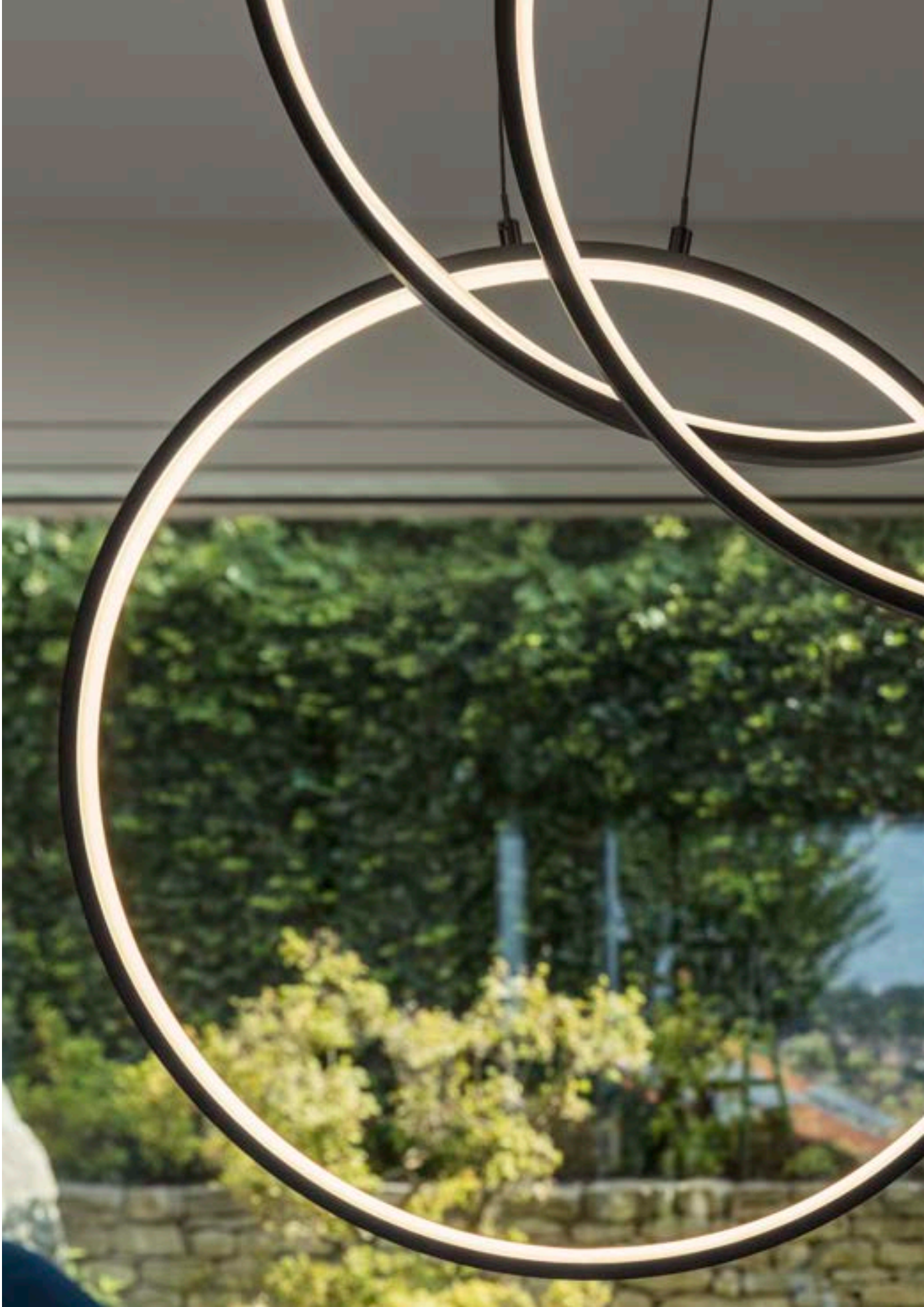




FRAME

Matt white or black varnished metal base and frame. Opal colour plastic diffusers. Adjustable in length cables. Direct light emission.

















GEMINI

Powder coated or plated metal ceiling rose and body.
Opal polycarbonate diffuser.
Clear PVC cable. Available finishes: white, black or brushed brass.
DALI/Push dimmable version available for the models with 810 mm and 610 mm diameter.













LOOK

Metal ceiling rose and diffuser with different finishes. Power cable coated with fabric adjustable in length. It fits replaceable bulbs. Faded chrome version with glass diffuser.

















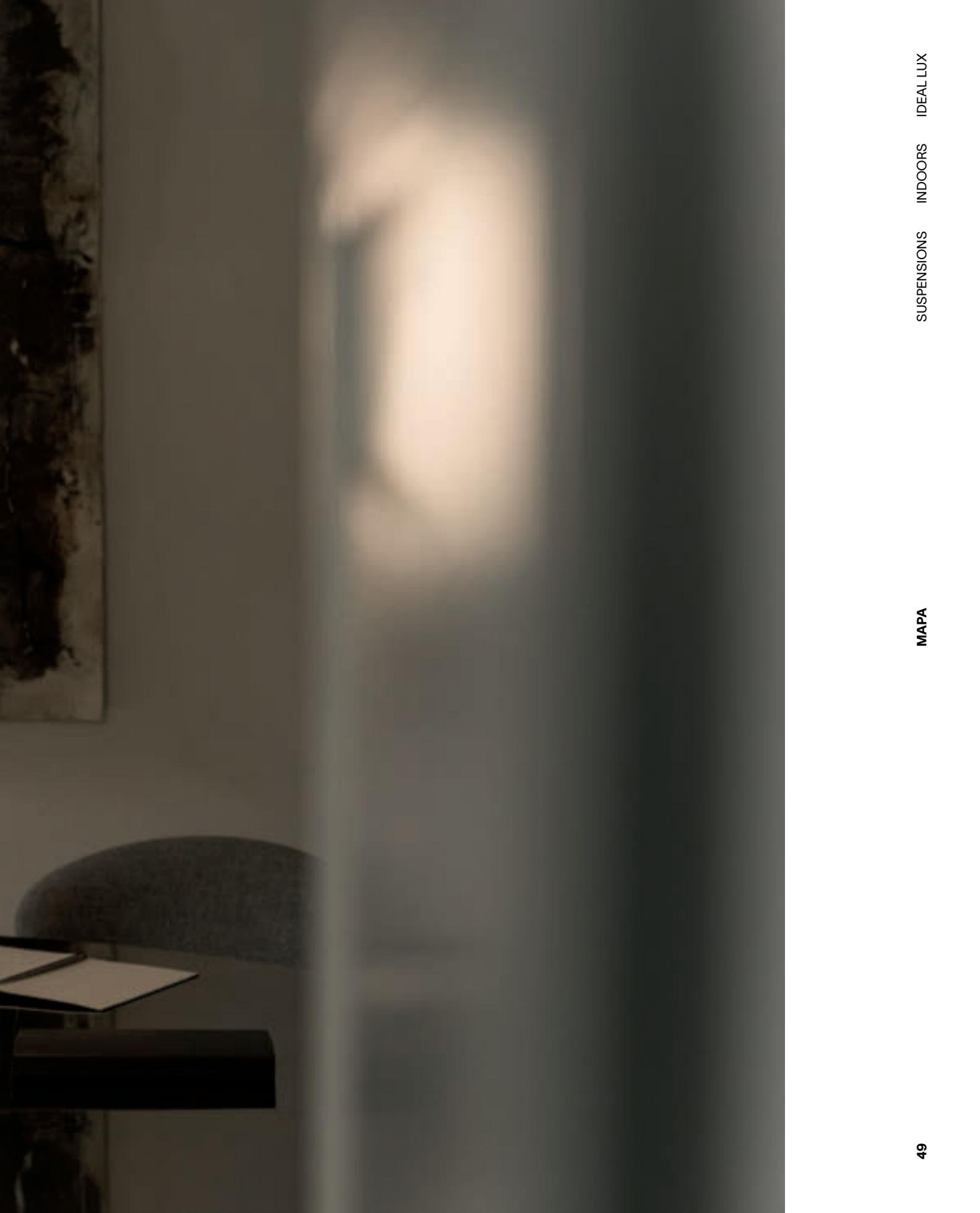
MAPA



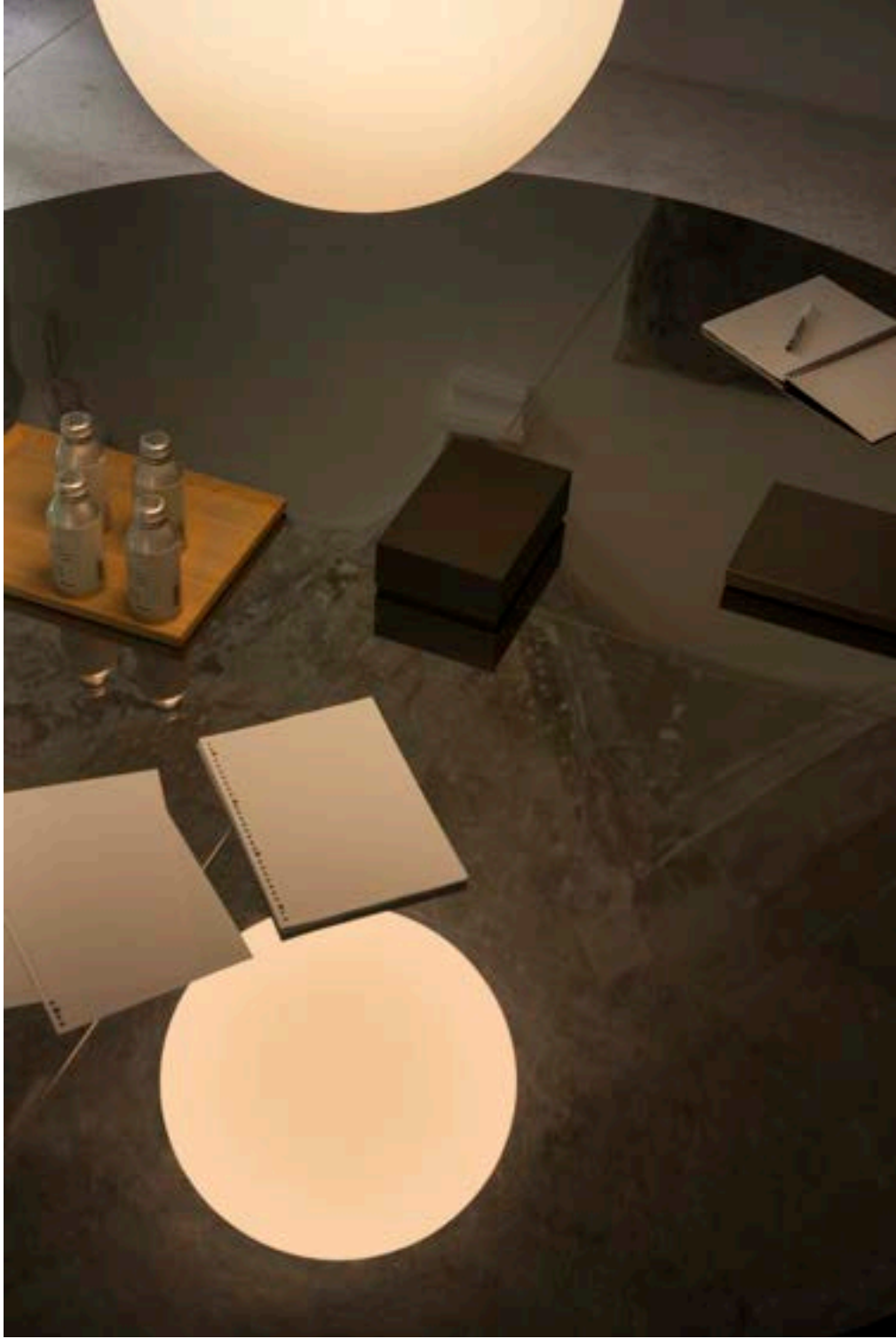
White metal frame. White spherical shape acid-etched blown glass diffuser. Steel cables adjustable in length.













MINT

Metal frame with satin brass finish and matt black ceiling rose. Power cable coated with fabric. Blown glass diffuser with stripes in relief. Available finishes: smoky or green.









MIX UP

Powder-coated varnished metal ceiling cap and interchangeable shades. PVC cable.

Finishes: white or black.



SUSPENSIONS INDOORS IDEAL LUX

MIX UP





















SUSPENSIONS INDOORS IDEAL LUX

MIX UP



MOBY

Metal frame and diffuser
white inside. Available finishes:
white, black or copper.









MOBY

SUSPENSIONS INDOORS IDEAL LUX



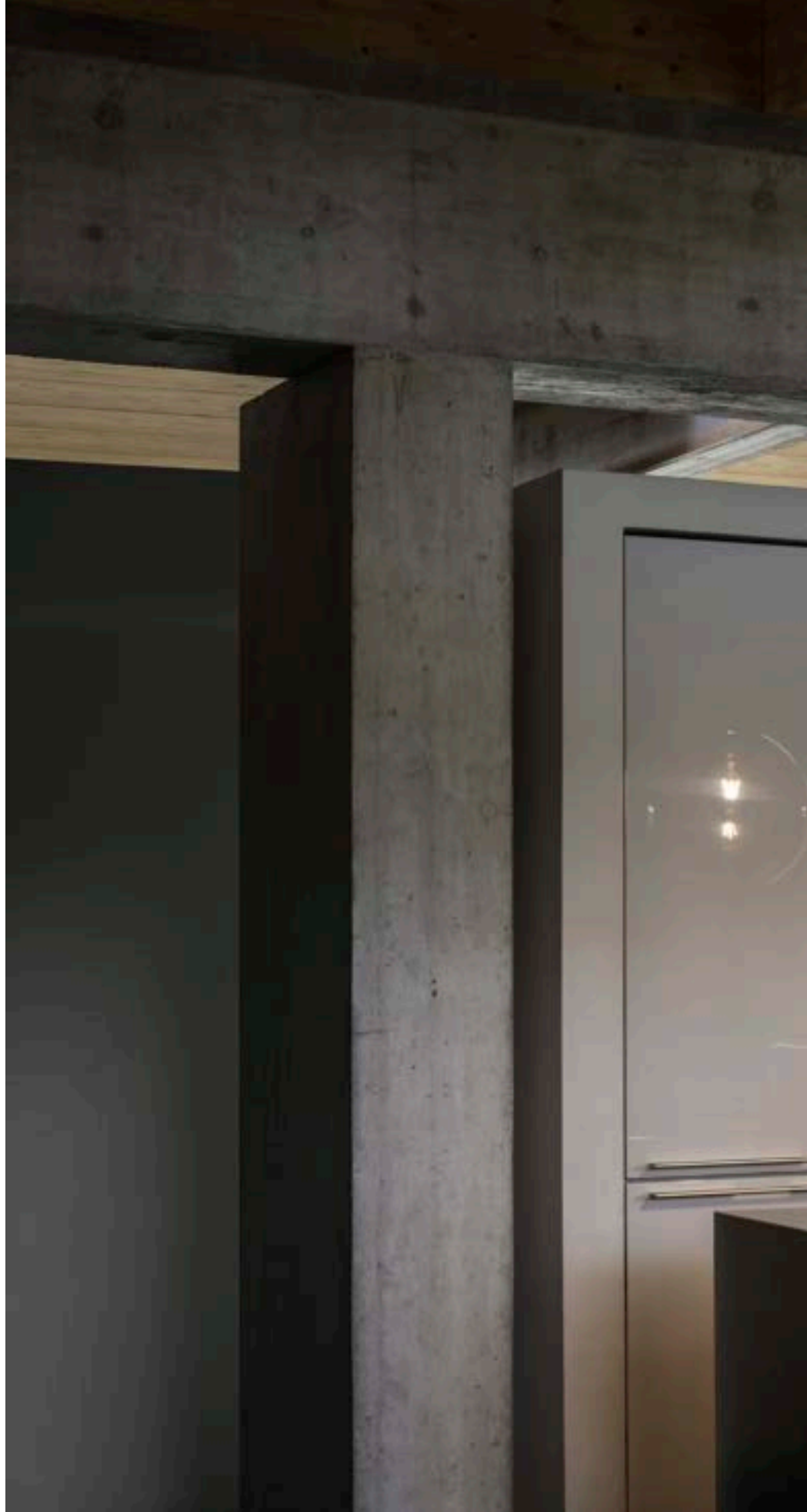




NEMO

Blown glass diffuser. Available with smoky, copper, amber, clear or faded chrome finishes.











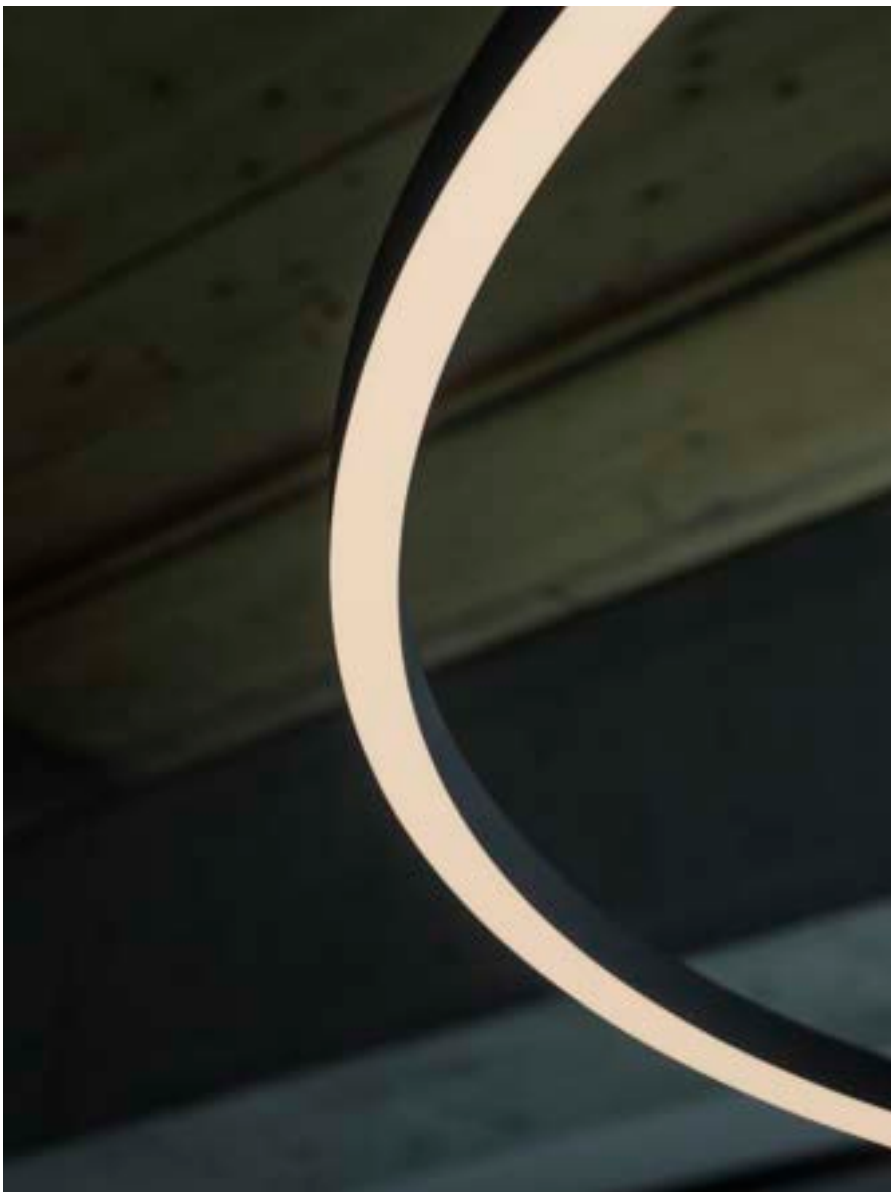


ORACLE SLIM

Suspended lamp consisting of a thin matt white or black painted aluminum frame and opal polycarbonate diffuser. Available in a round version (four different sizes) and a squared one (three different sizes).

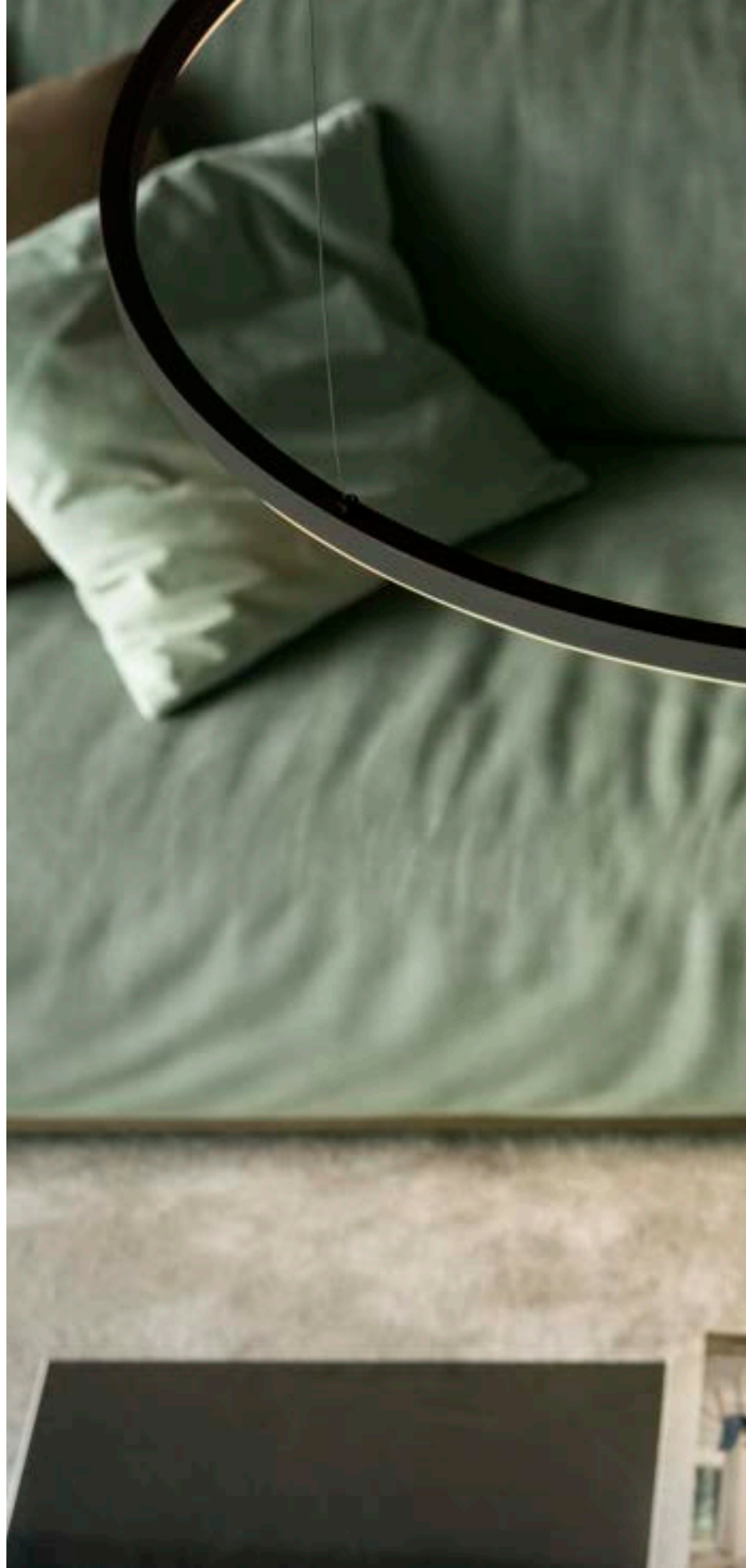














OZ



Plated or powder coated metal base and frame. PVC wires. Opal rubber diffuser. Available finishes: white, black or brushed brass. DALI/Push dimmable version available.













PERLAGE

Metal frame with linear structure with round section or with circular structure with square section. Blown glass diffusers. PVC electrical cable. Colors: matt black frame with smoked glass, satin brass frame with etched white glass or satin brass frame with amber glass.













SMARTIES

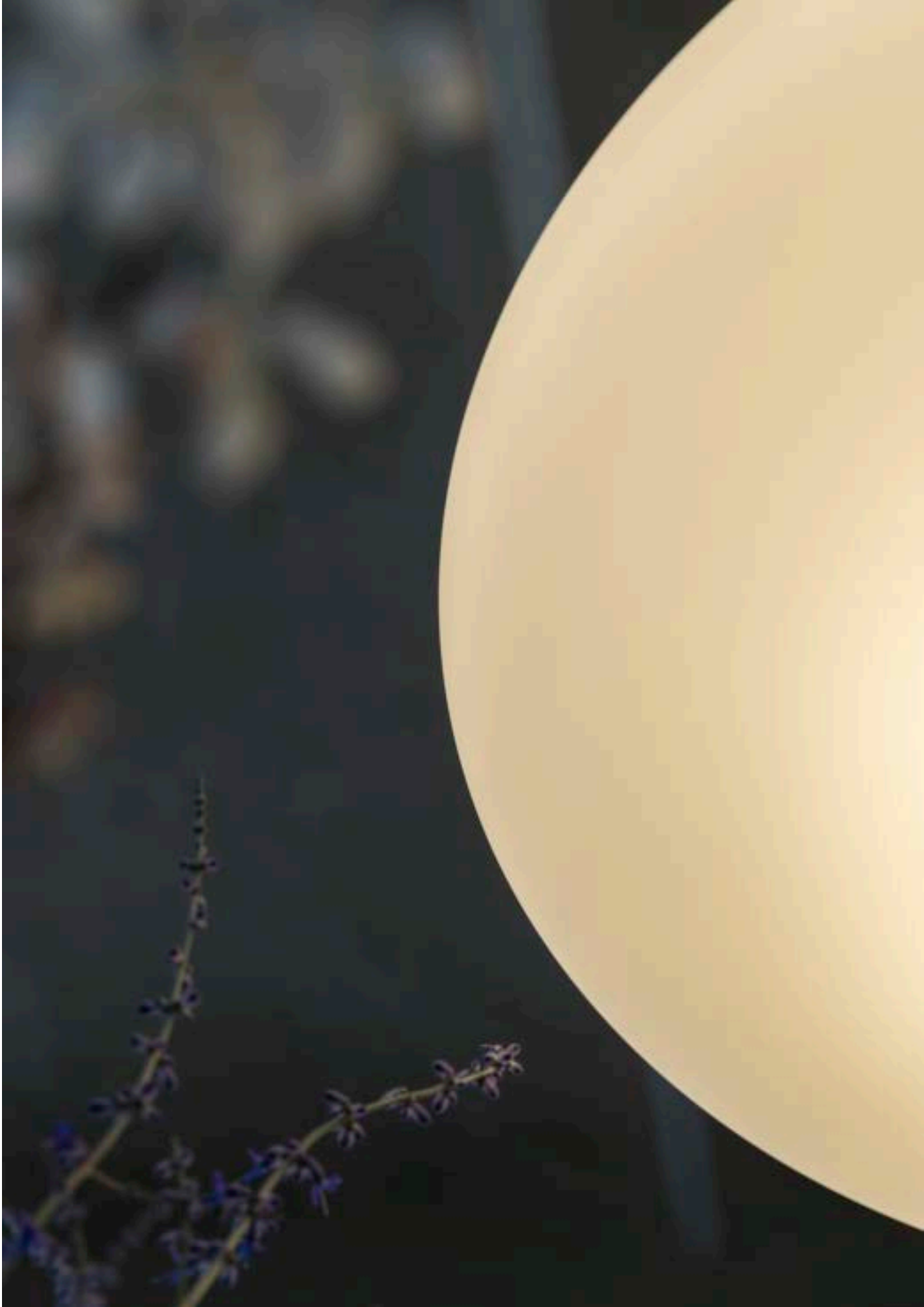
White varnished metal frame.
White blown glass diffuser. Steel
cables adjustable in length with
automatic blocking mechanism.













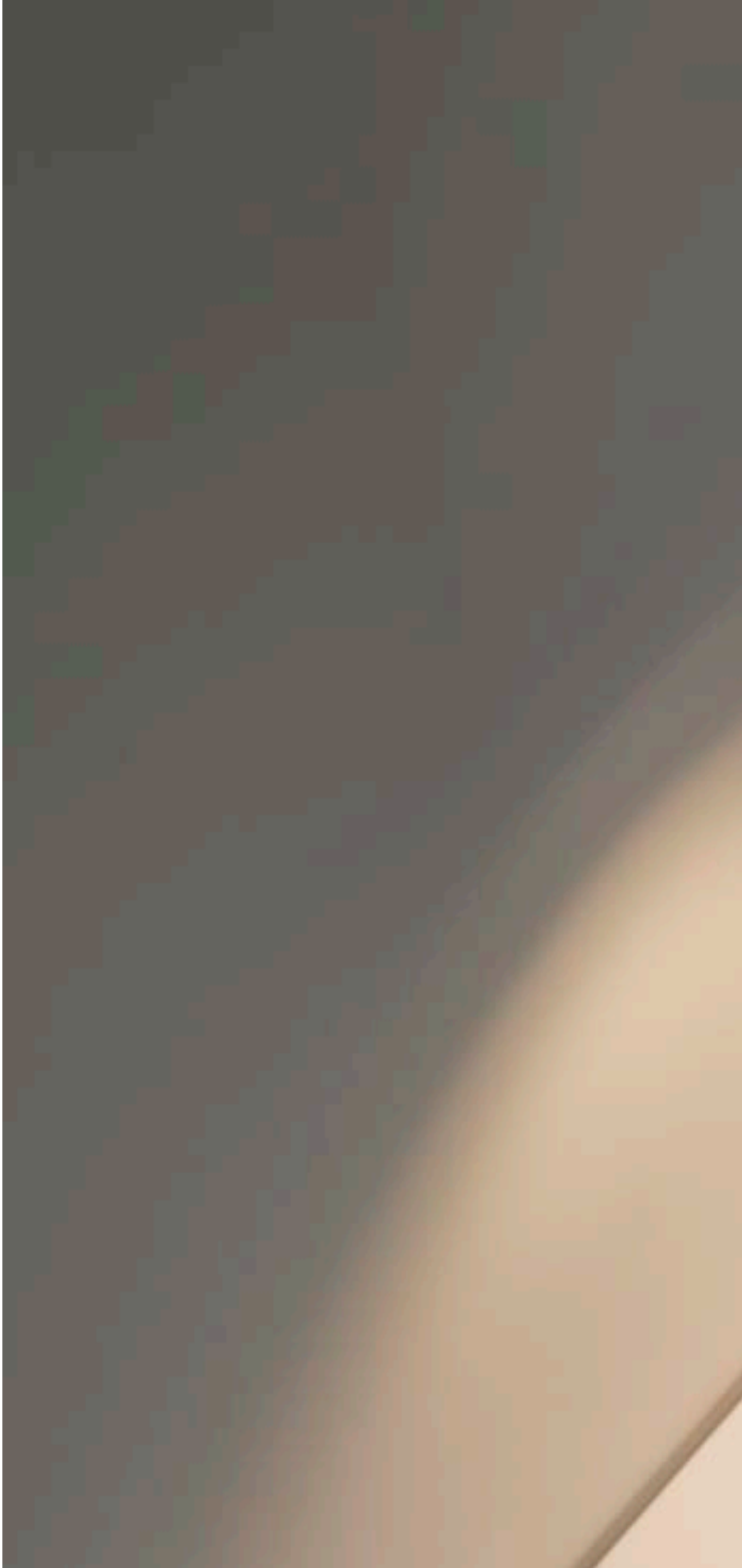


ULTRATHIN

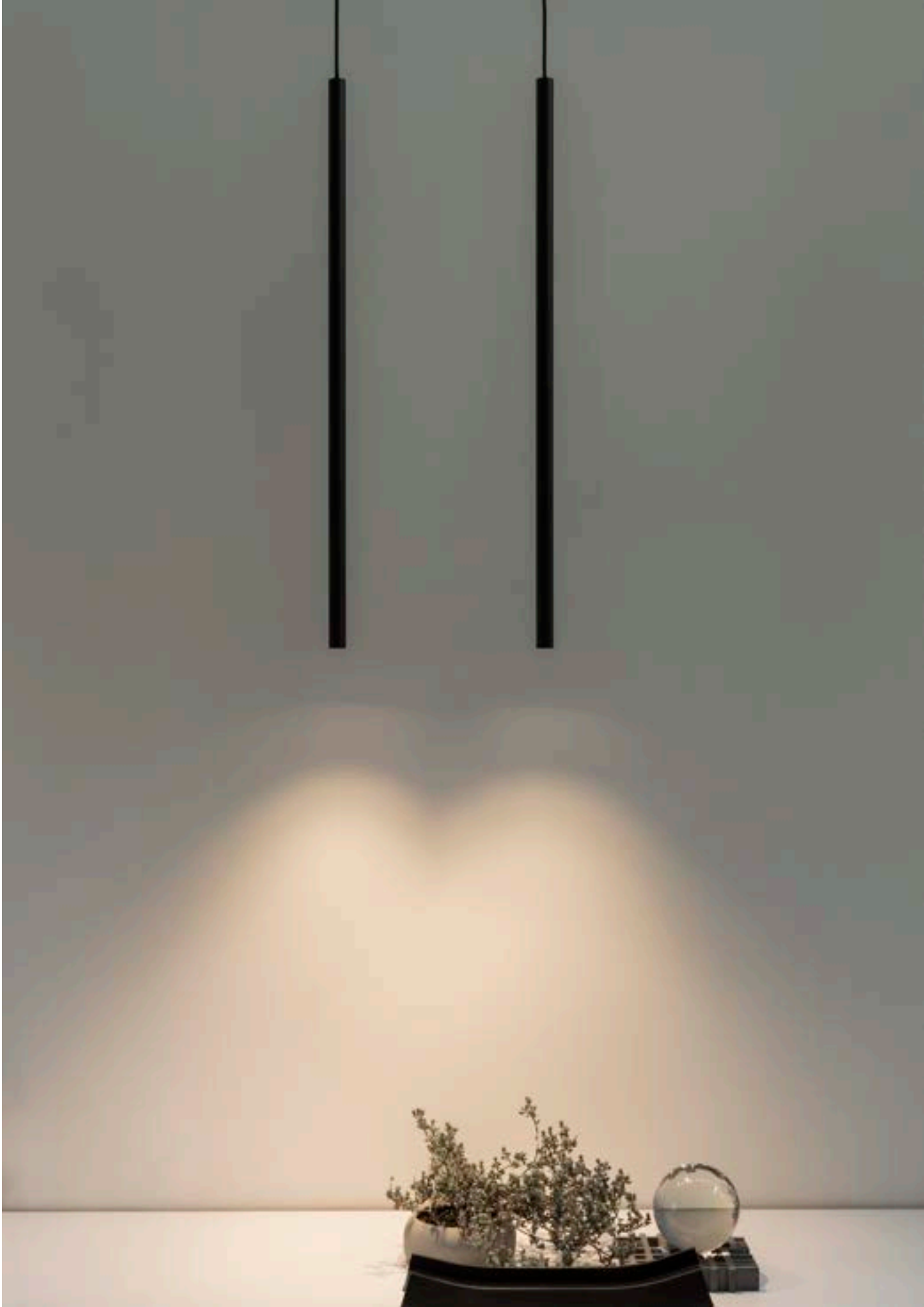
Matt painted or plated metal ceiling cap and body. Electrical cable coated with fabric. Colors: white, chrome, brushed brass or black.













CEILING LAMPS

CHILDREN
LAUGHING,
MESSY
KITCHEN,
FLOURY
HANDS,
SATISFIED
SMILES,
FRAGRANT
DESSERTS
LIT LAMPS,
SHADOWS
DANCING,
MEMORIES
MADE.





Index

↳

114 **Birds**
118 **Dynamite**
124 **Fly**
130 **Frame**
134 **Nitro**
138 **Spike**

DATASHEETS ONLY

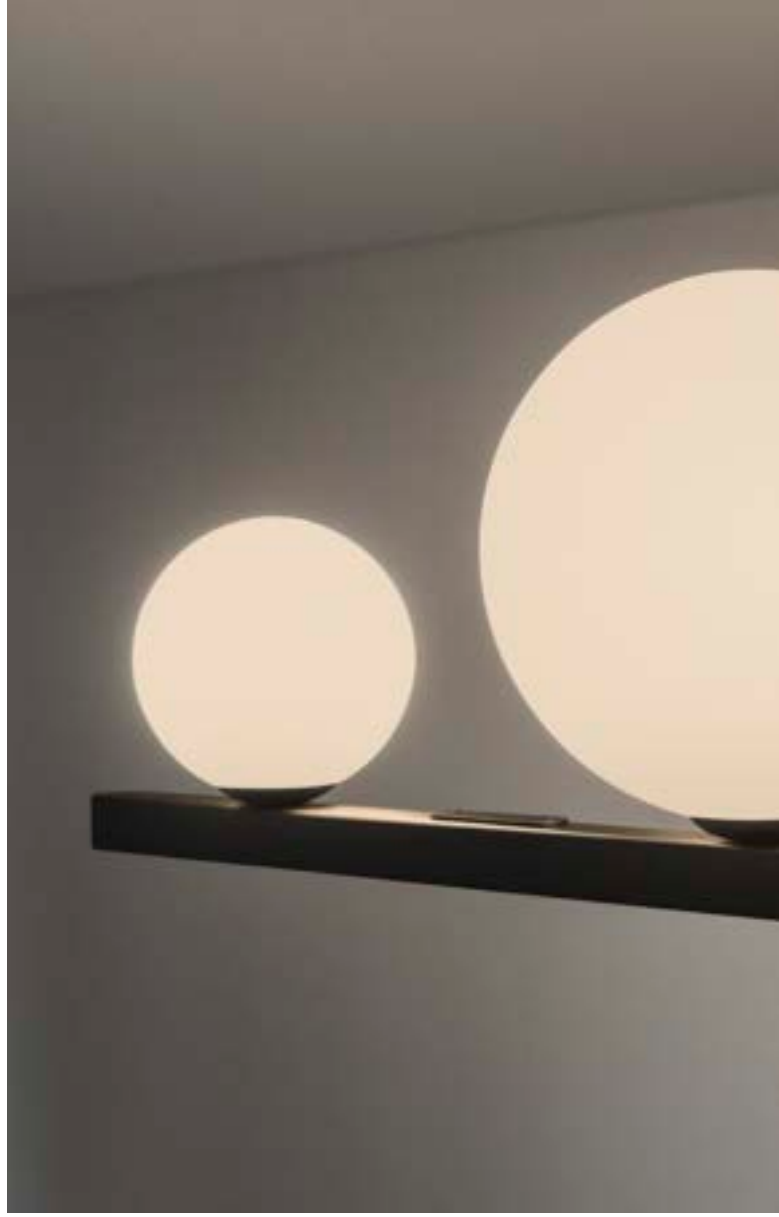
509 Gemini
511 Look
514 Mapa
515 Mix Up
518 Ninfea
523 Oracle Slim
524 Oz
526 Perlage
528 Set Up
532 Smarties



BIRDS

Varnished metal frame with
satin brass decorative disc.
White acid-etched blown glass
diffusers. Color: matt black
with satin brass detail.









DYNAMITE

Powder coated or plated or brushed metal frame. Adjustable diffusers.











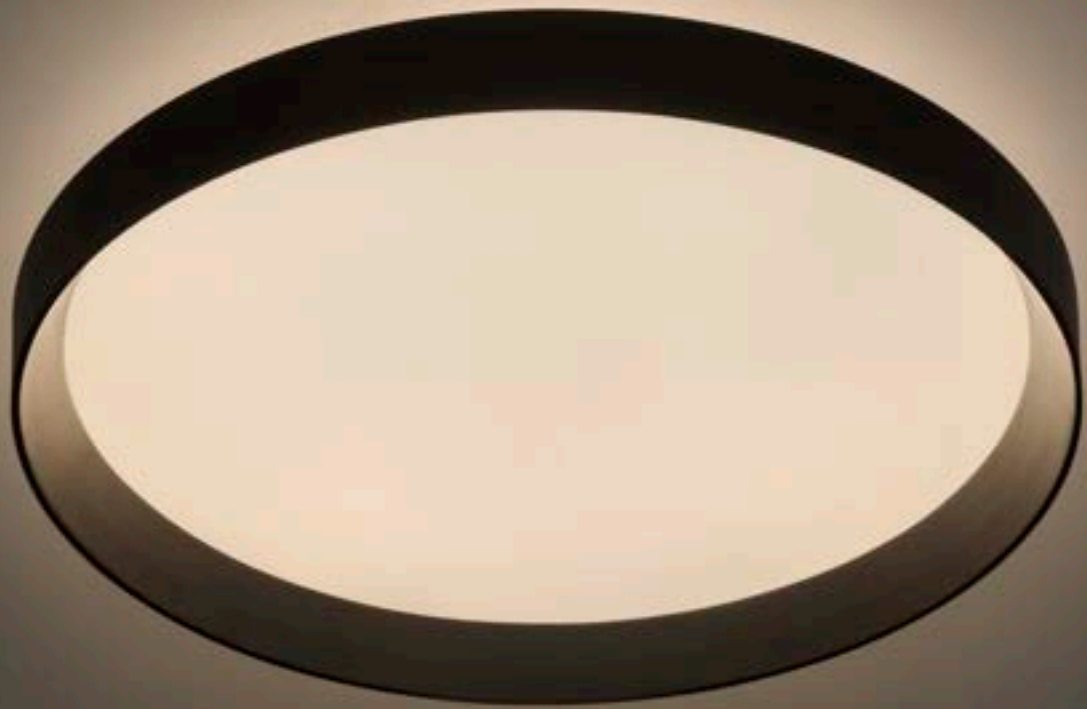


FLY

Family composed by ceiling lamps with circular base, available with four different diameters (350 mm, 450 mm, 600 mm, 900 mm) and also in SLIM version with a more compact height. Powder coated aluminum body with white finish RAL 9016 and black finish RAL 9004, recessed optics (FLY PL) or flush (FLY SLIM) with PMMA microprismatic diffuser with glare control (UGR < 19). The lamp is ready to be integrated with the upright accessory module for the indirect light part.









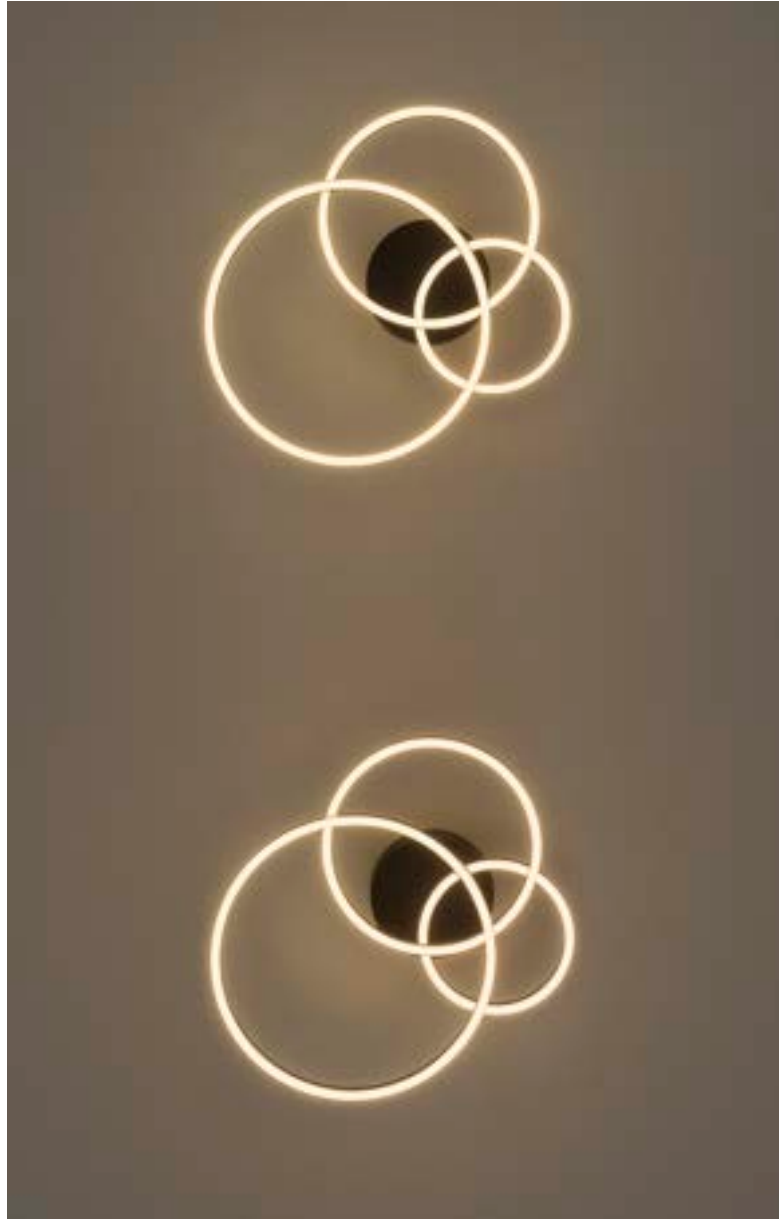




FRAME

Matt white or black varnished metal base and frame. Opal colour plastic diffusers. Direct light emission.







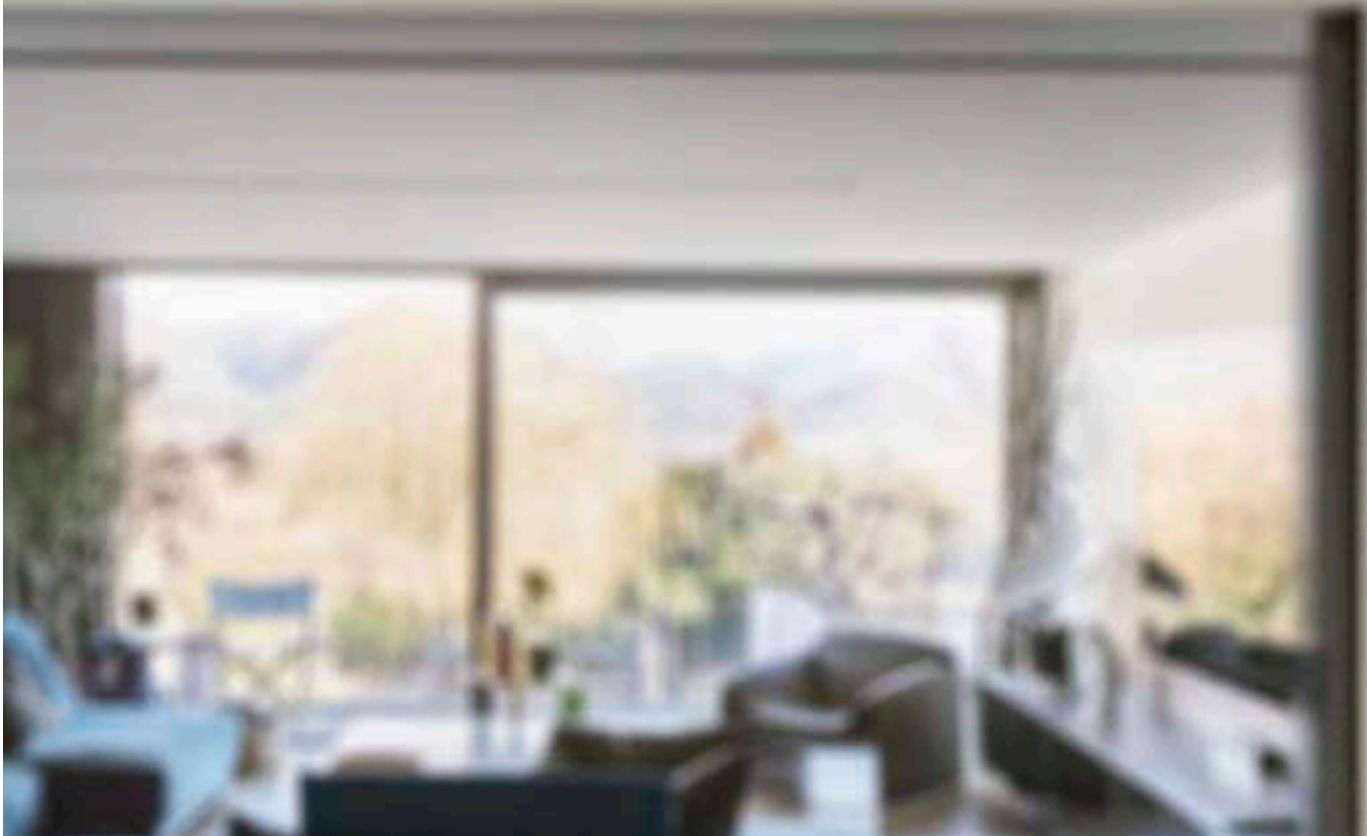


NITRO

White or black matt varnished aluminum body. Internally finished with plastic mask. Integrated LED source with lens.







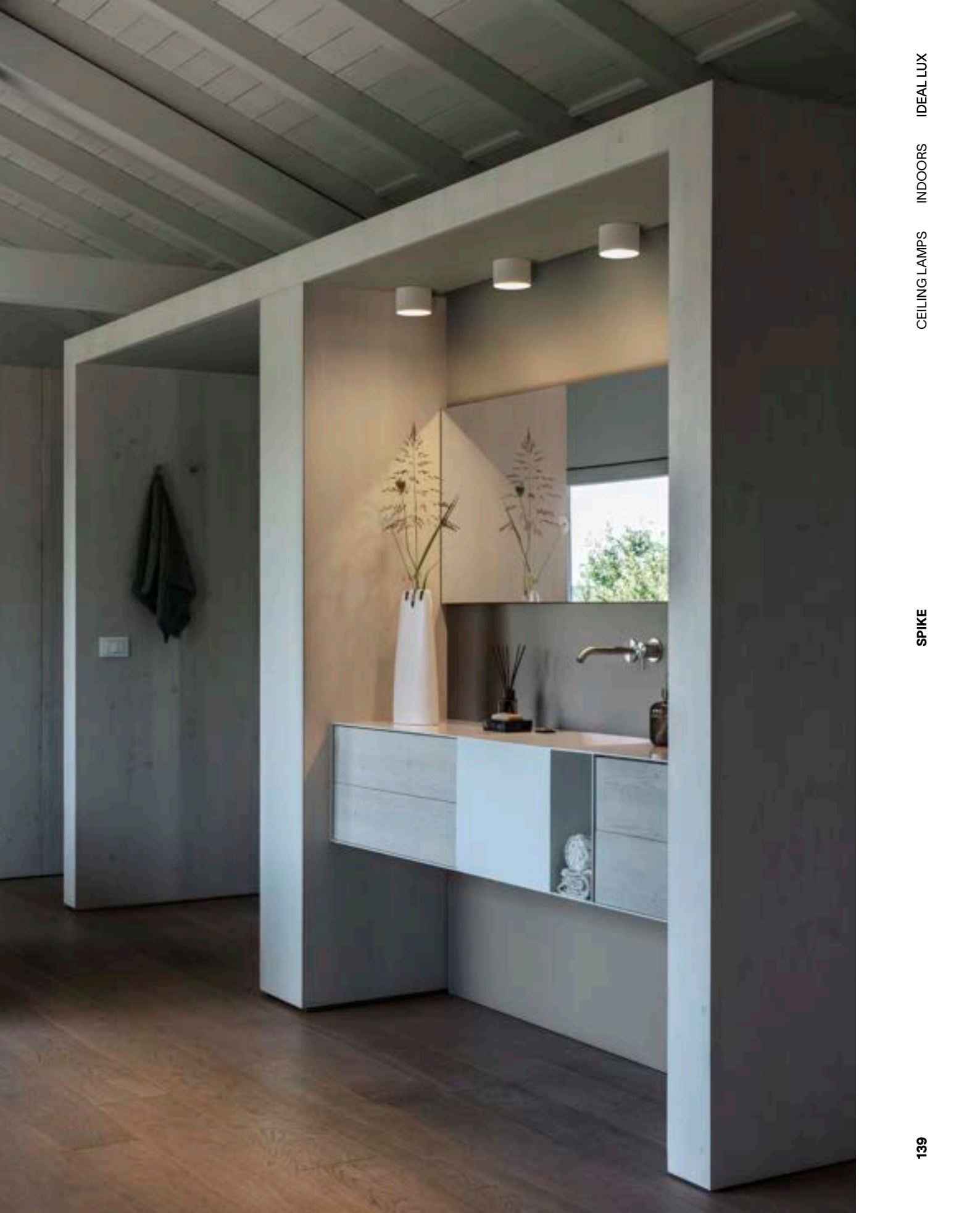




SPIKE

Powder coated or plated aluminum body. Available with GX53 or integrated LED source with satin opal polycarbonate diffuser. Colors: white, black or satin brass.





CEILING LAMPS INDOORS IDEAL LUX

SPIKE





WALL LAMPS

DREAMS
DANCING,
OPEN PAGES,
GENTLE
LIGHT,
WORDS
FLOATING,
NIGHTTIME
EMBRACES,
CRUDLING
SILENCE,
NIGHT
LISTENING,
STORIES
INTERWEAVING,
DREAMS
SOARING.





Index



144	Bean
148	Binomio
152	Clip
156	Cover
162	Delta
168	Essence
174	Focus
178	Ninfea
184	Piano
188	Set Up
192	Zig Zag

DATASHEETS ONLY	490	Birds
	498	Equinoxe
	500	Filo
	600	Linus
	511	Look
	513	Mapa
	525	Oz
	527	Perlage
	533	Smarties



BEAN

Directable plated or powder coated metal base and diffuser. White, black, brass or nichel color with black switch and junction.











BINOMIO

Metal frame. White acid-etched blown glass diffusers with screw fastening. Finishes: white, black, brushed brass.







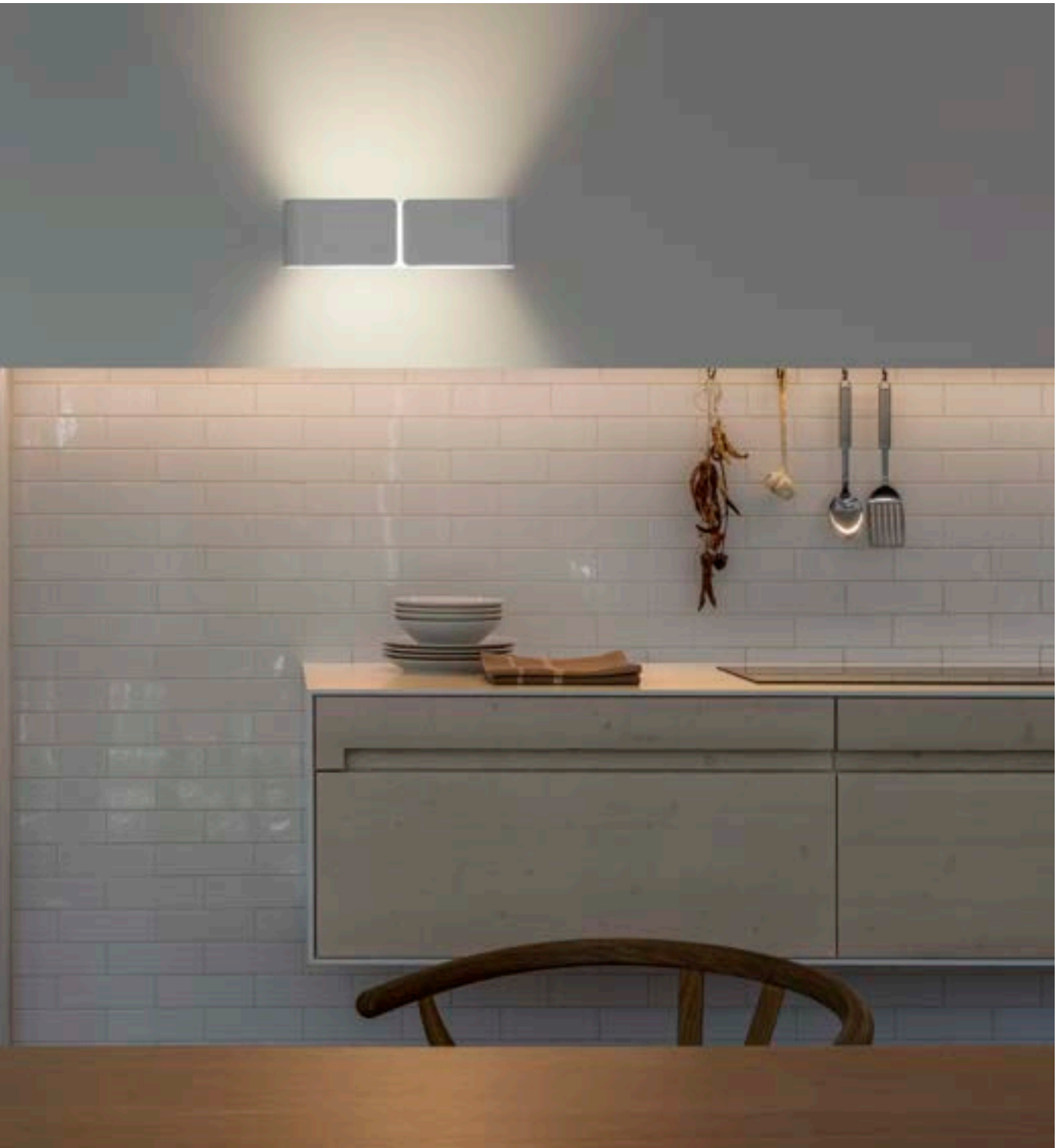




CLIP

Metal sheet body with different finishes. Small size models supplied with sandblasted Pyrex glass diffusers.







CLIP

WALL LAMPS

INDOORS

IDEAL LUX

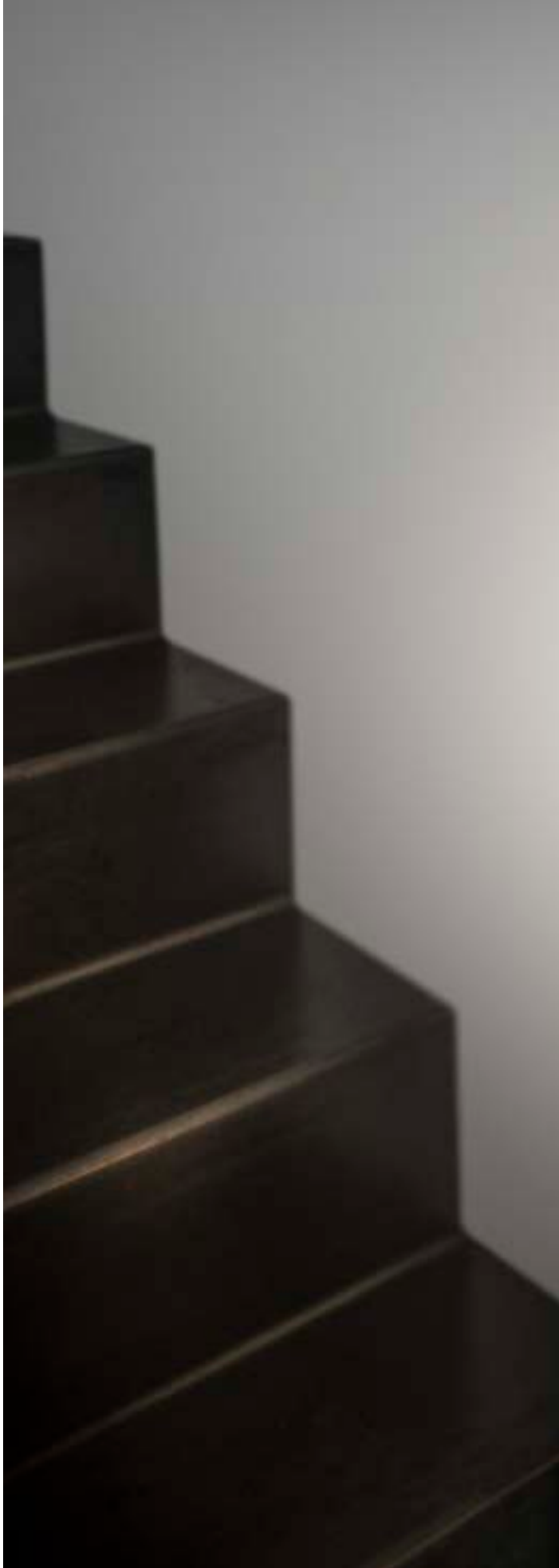


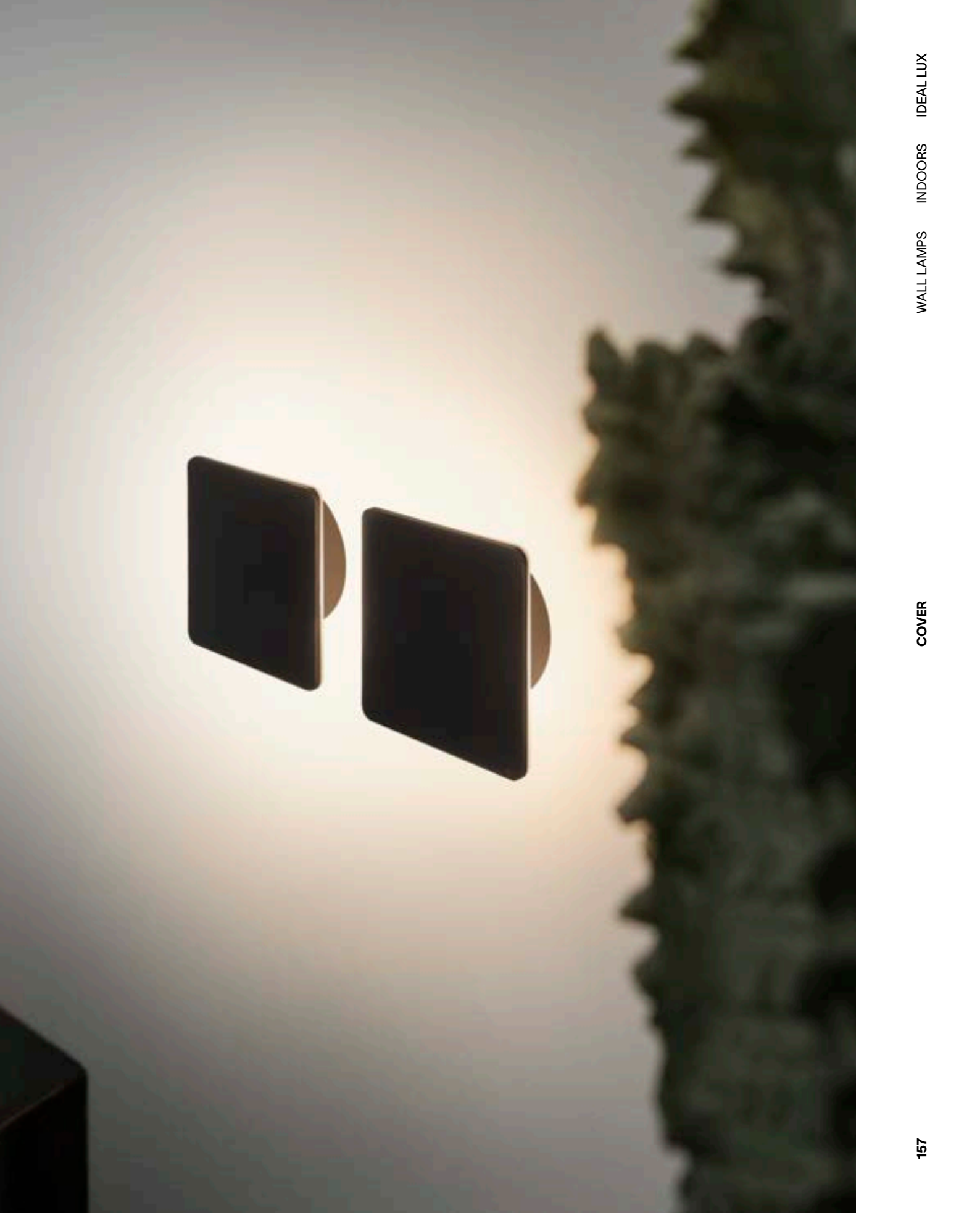




COVER

White or black powder painted aluminum body. Opal color plastic diffuser. Light source made of integrated LED with mirrored light emission.







COVER

WALL LAMPS

INDOORS

IDEAL LUX











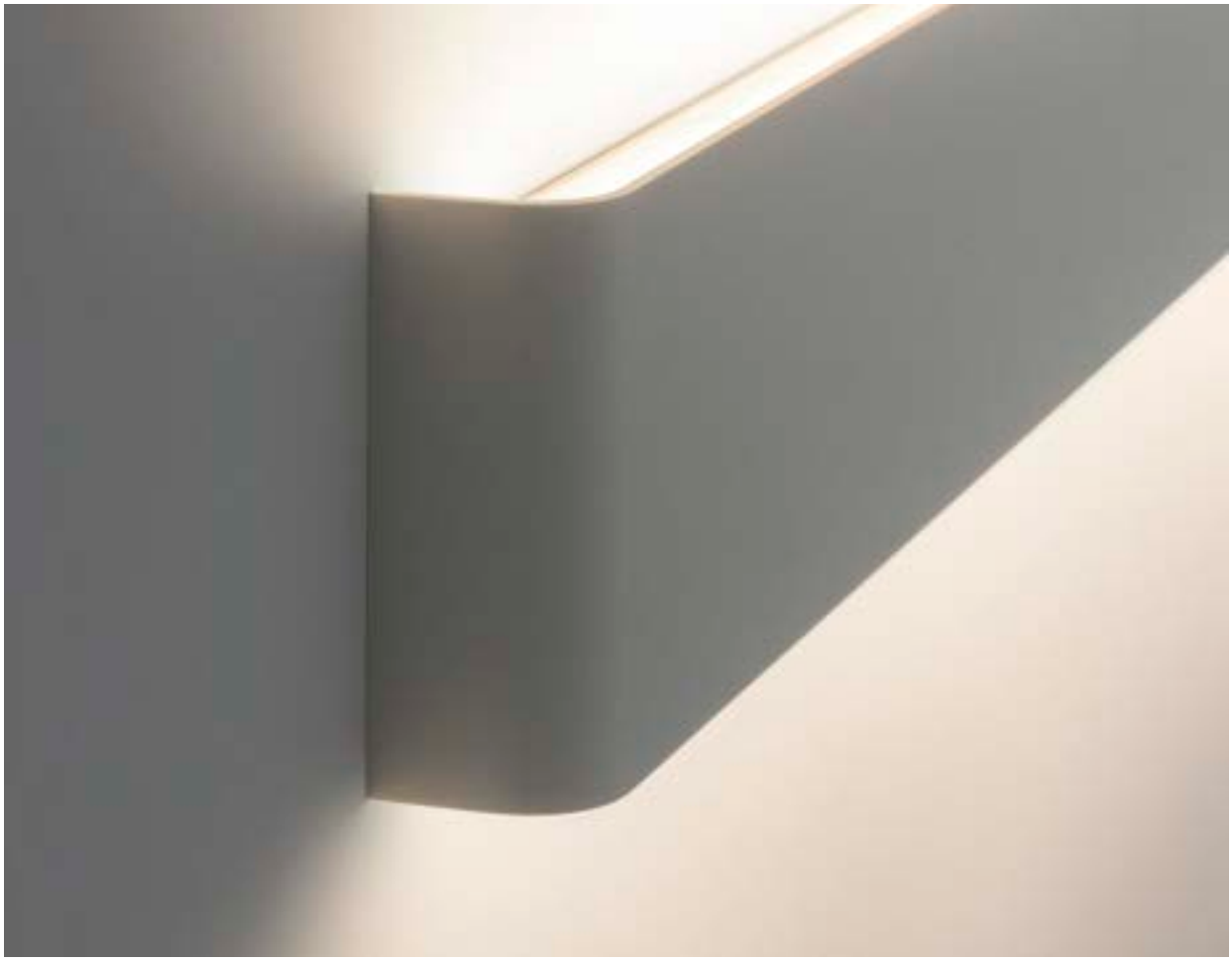
DELTA

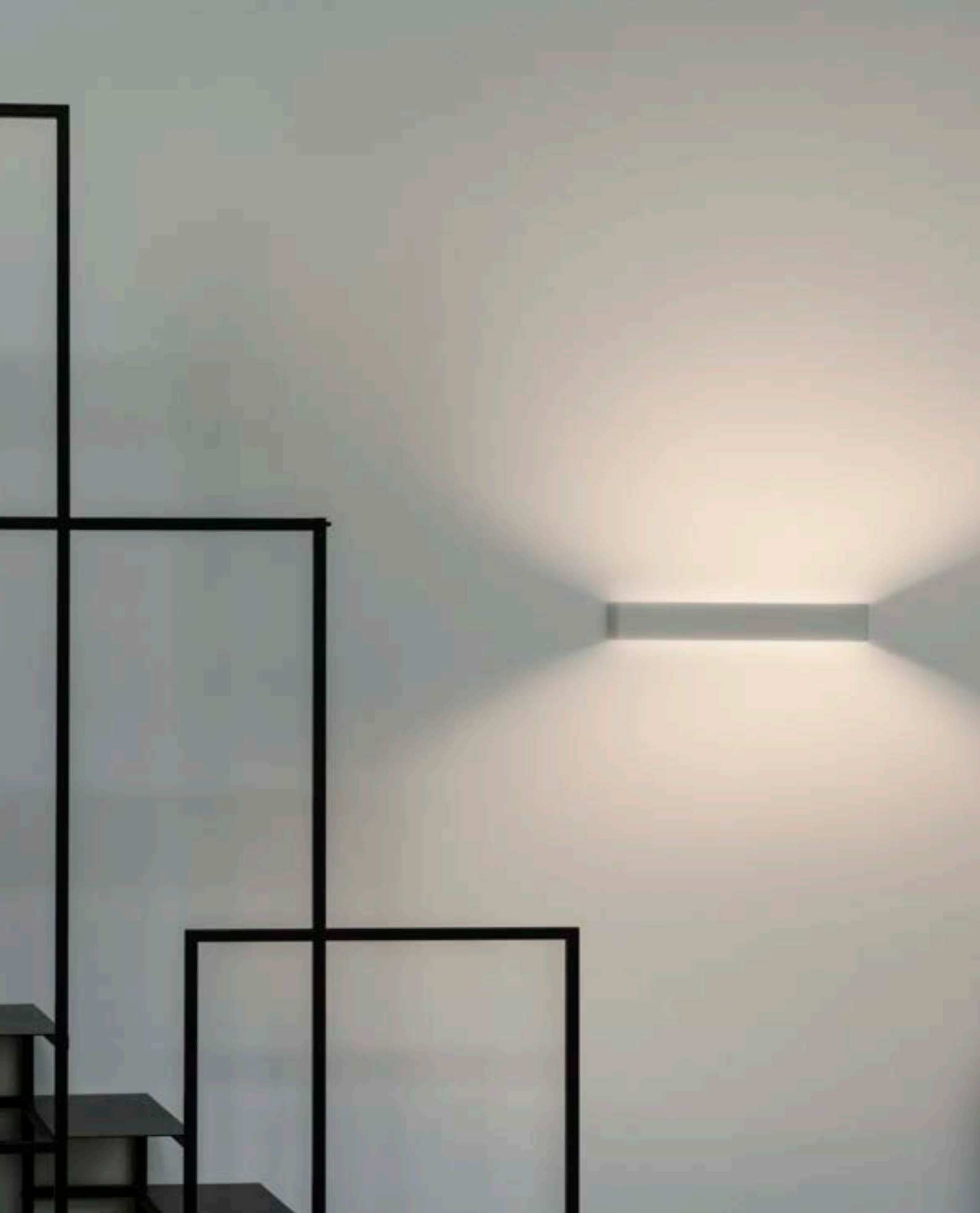
Powder-coated aluminum body.
Shiny opal polycarbonate diffusers.
Upward and downward light
emission. Colours: black and white.















ESSENCE

Powder coated aluminum base and body. Opal color acrylic diffuser. Indirect lighting emission. Color: white or black.



WALL LAMPS INDOORS IDEAL LUX

ESSENCE









WALL LAMPS INDOORS IDEAL LUX

ESSENCE



FOCUS

Metal body with adjustable arm coated with rubber. Finished in white or black matt colour or in grey with chrome details.







WALL LAMPS INDOORS IDEAL LUX

FOCUS

NINFEA

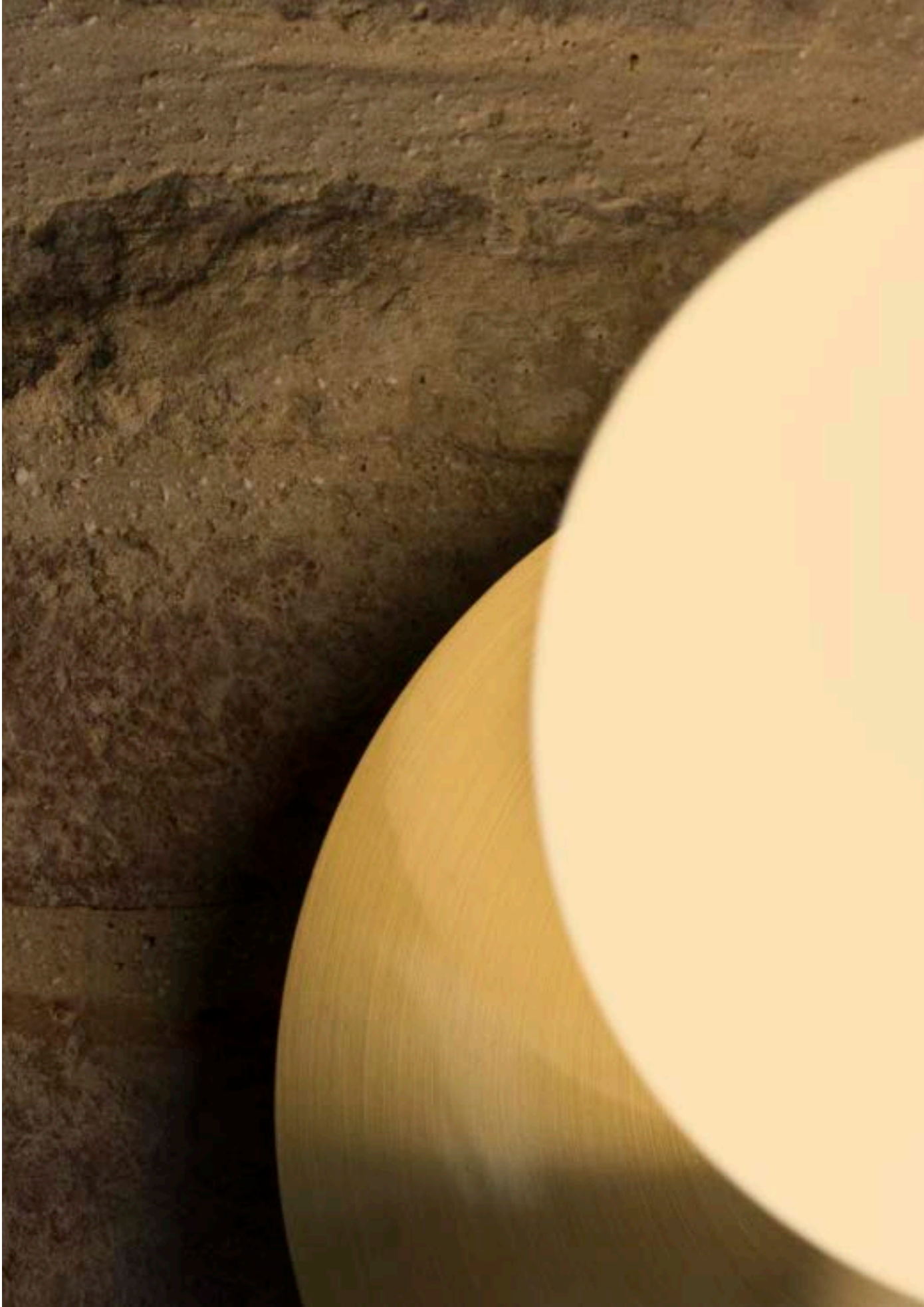


Plated or powder-coated metal base. White overlay, acid-etched blown glass diffusers. Available finishes: white or satin brass.











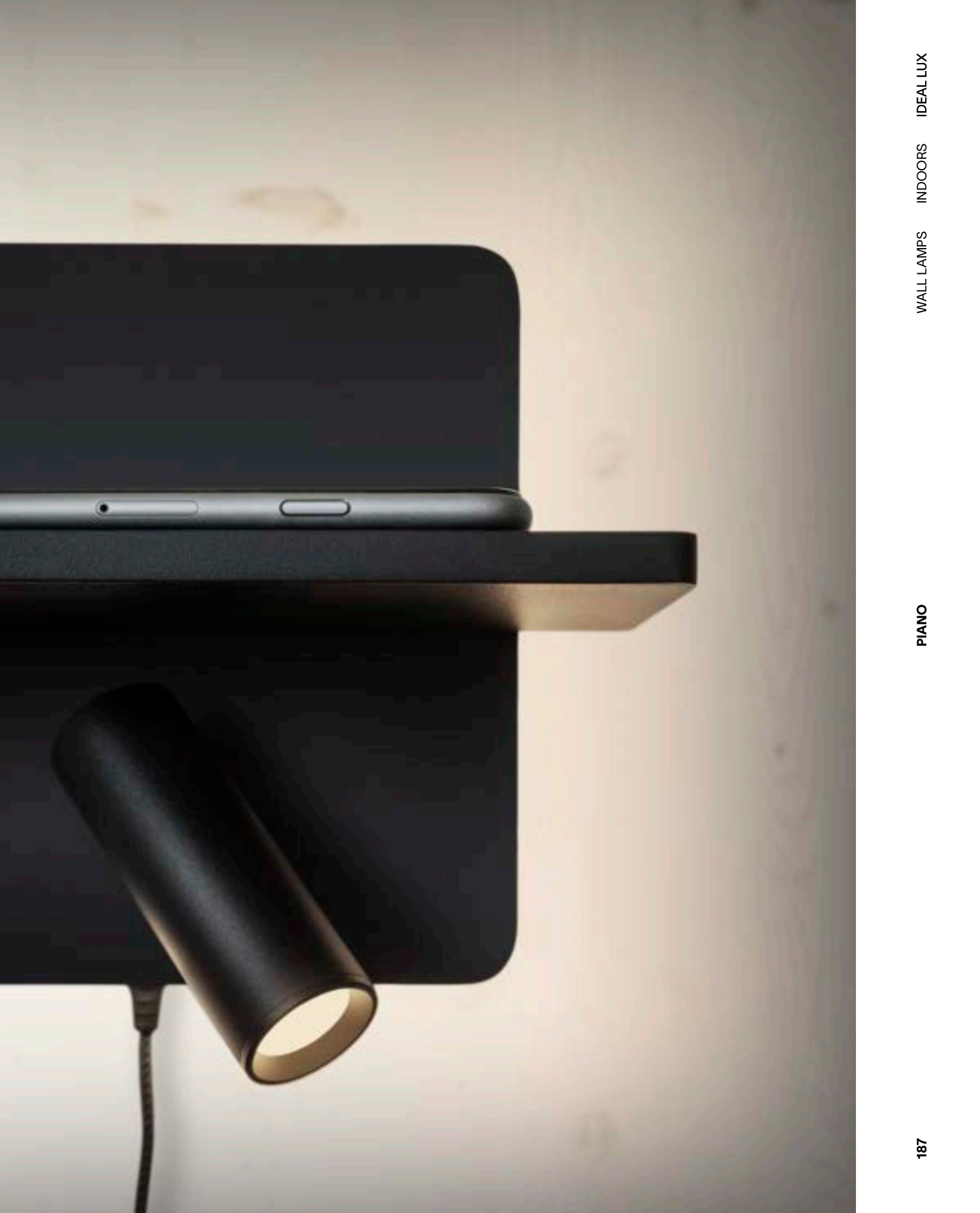


PIANO

Total powder painted aluminium frame. Opal polycarbonate diffuser with emission on the back. Adjustable frontal projector. Colours: white or black.









SET UP

Powder coated or plated metal frame. Two-light version with rubber-coated flexible arm and independent switches. Lampshades made of fireproof PVC covered with fabric. Frame colors: white, black, satin nickel or brushed brass with black details. Lampshade colors: beige, white, black, dove grey, wood.







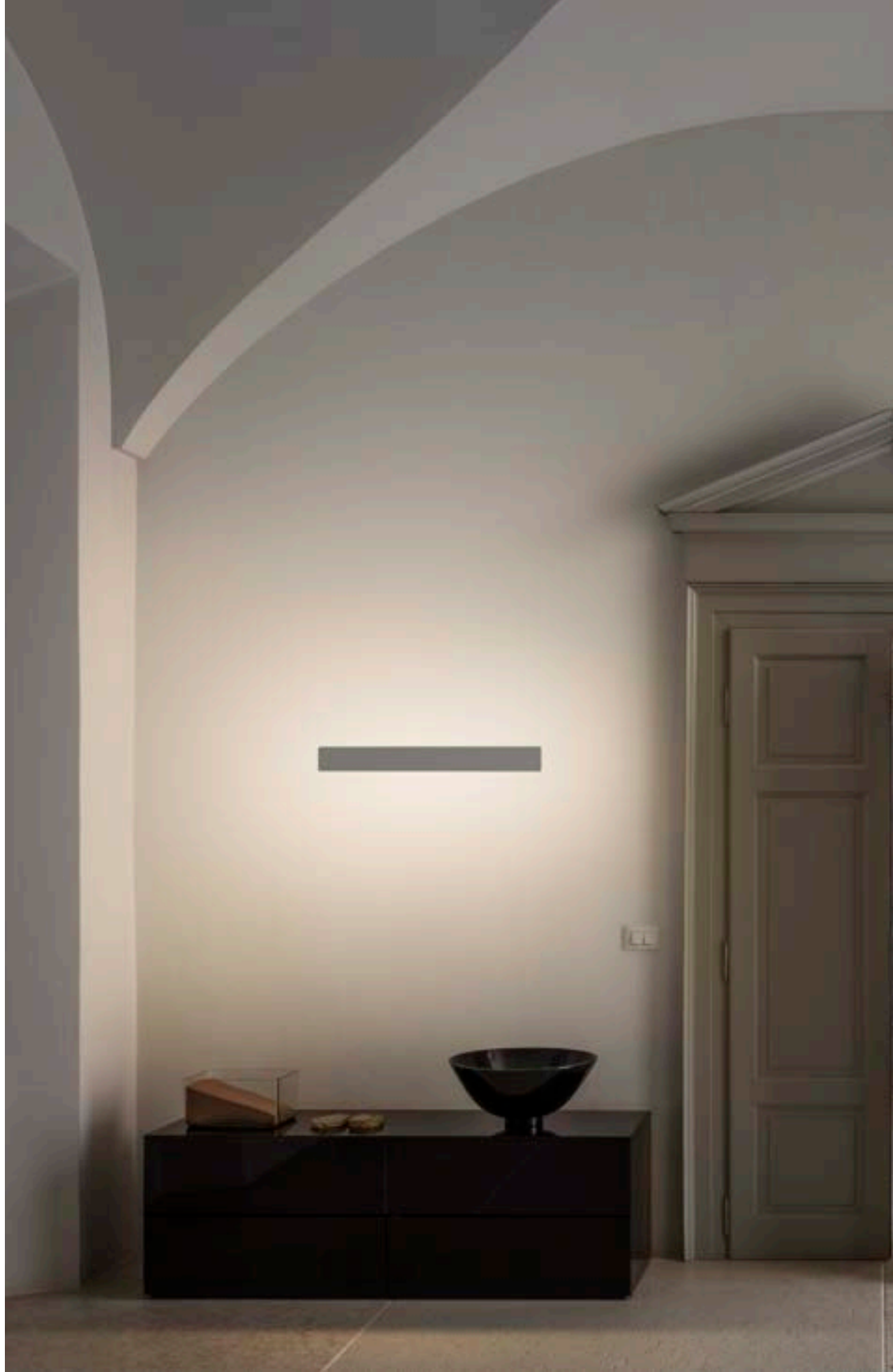




ZIG ZAG

Plated or powder coated aluminum body. 360° indirect light emission.
Colors: white, black or brushed brass.







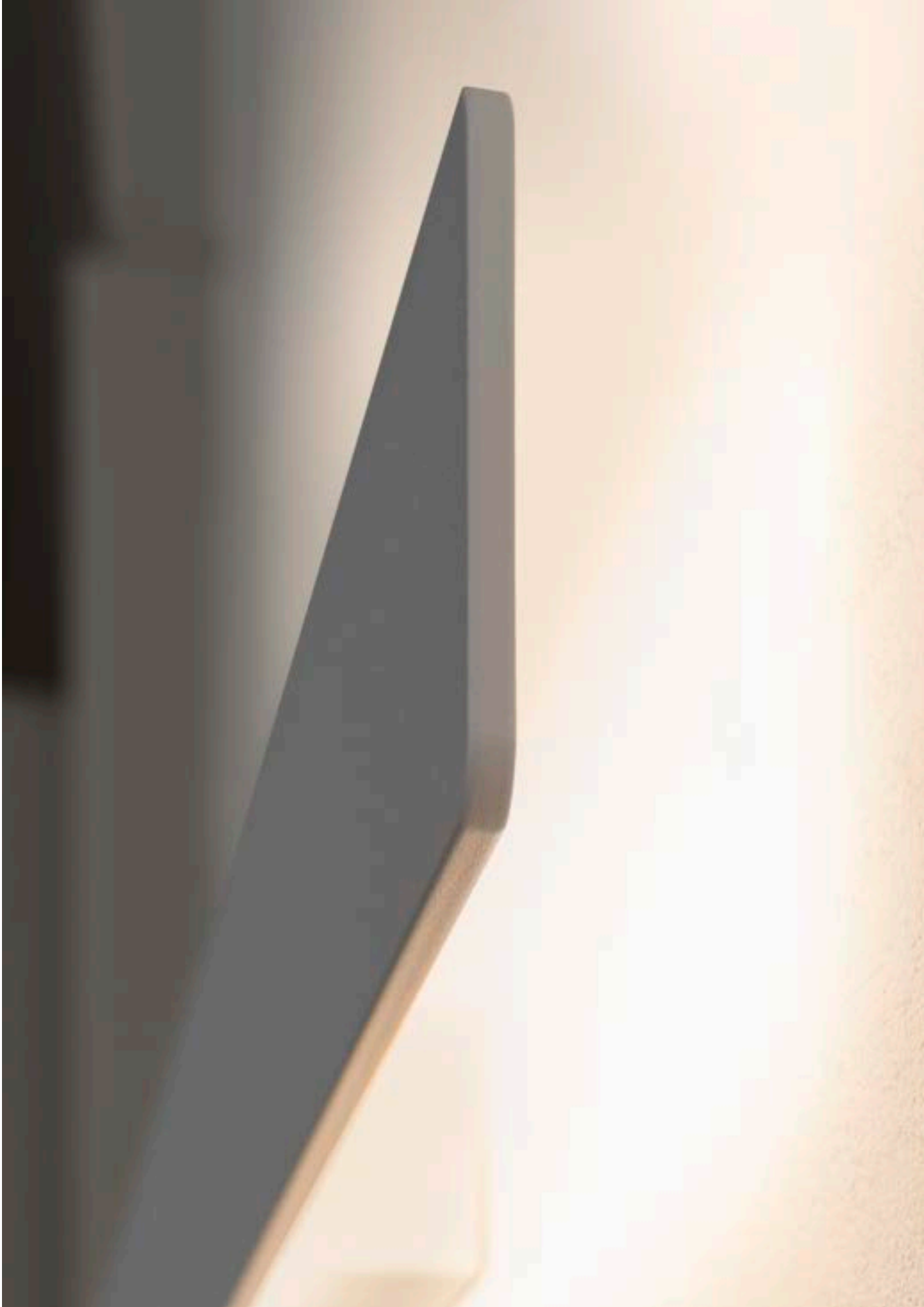




TABLE LAMPS

SCRIBBLED
NOTES,
BLOSSOMED
IDEAS,
ATTENTIVE
LIGHT,
THAT INSPIRES.
ENLIGHTENED
IDEAS,
STEADY
FOCUS.
FLUID
THOUGHTS,
DANCING.





Index

↳

200 **Futura**
206 **Mapa**
212 **Oz**
220 **Set Up**

DATASHEETS ONLY
490 Birds
493 Diesis
501 Filo
527 Perlage
533 Smarties



FUTURA

Articulated aluminum and plastic
arm with PVC exposed wire.
Adjustable LED diffuser
and integrated switcher.
Plug with power supply.













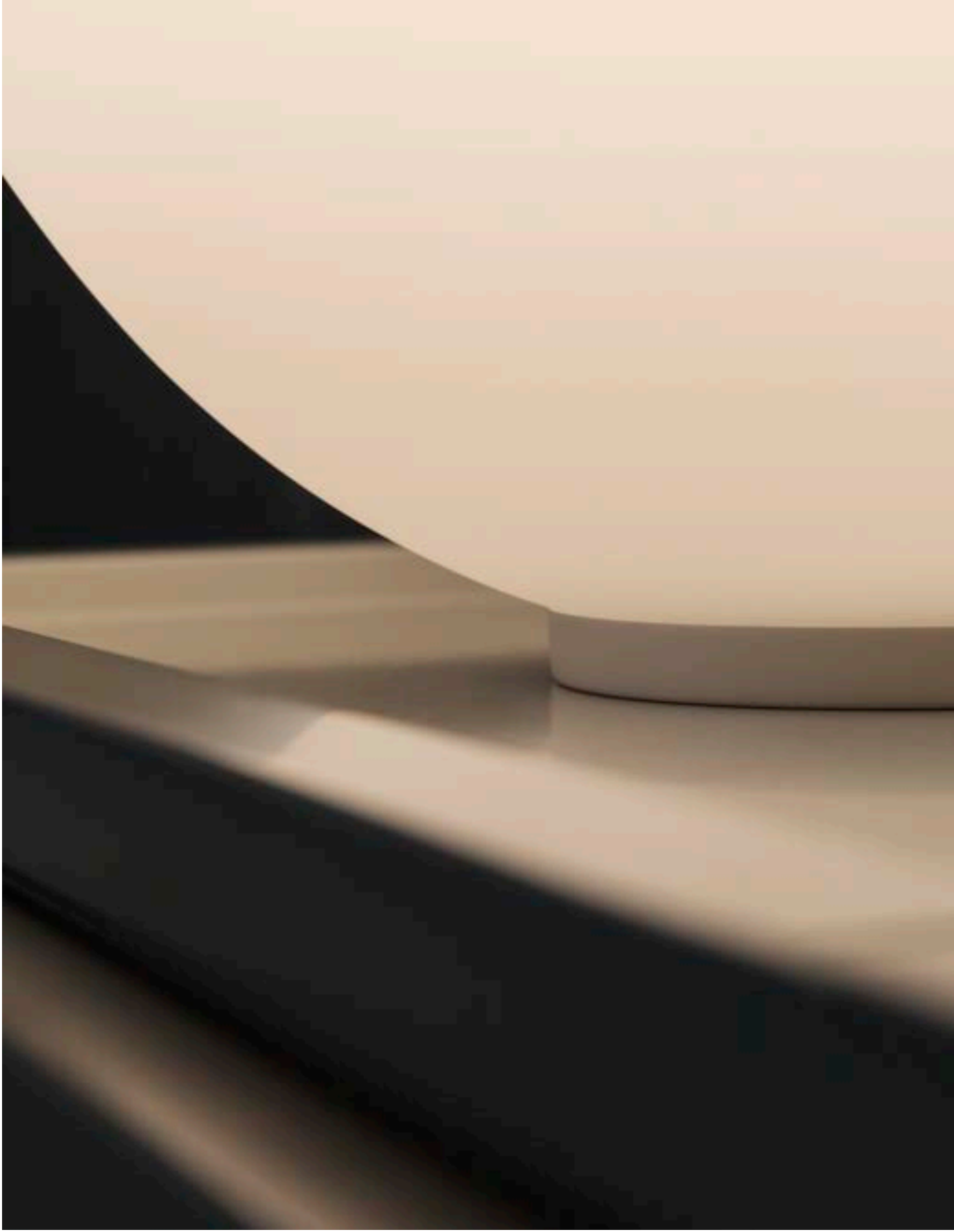
MAPA

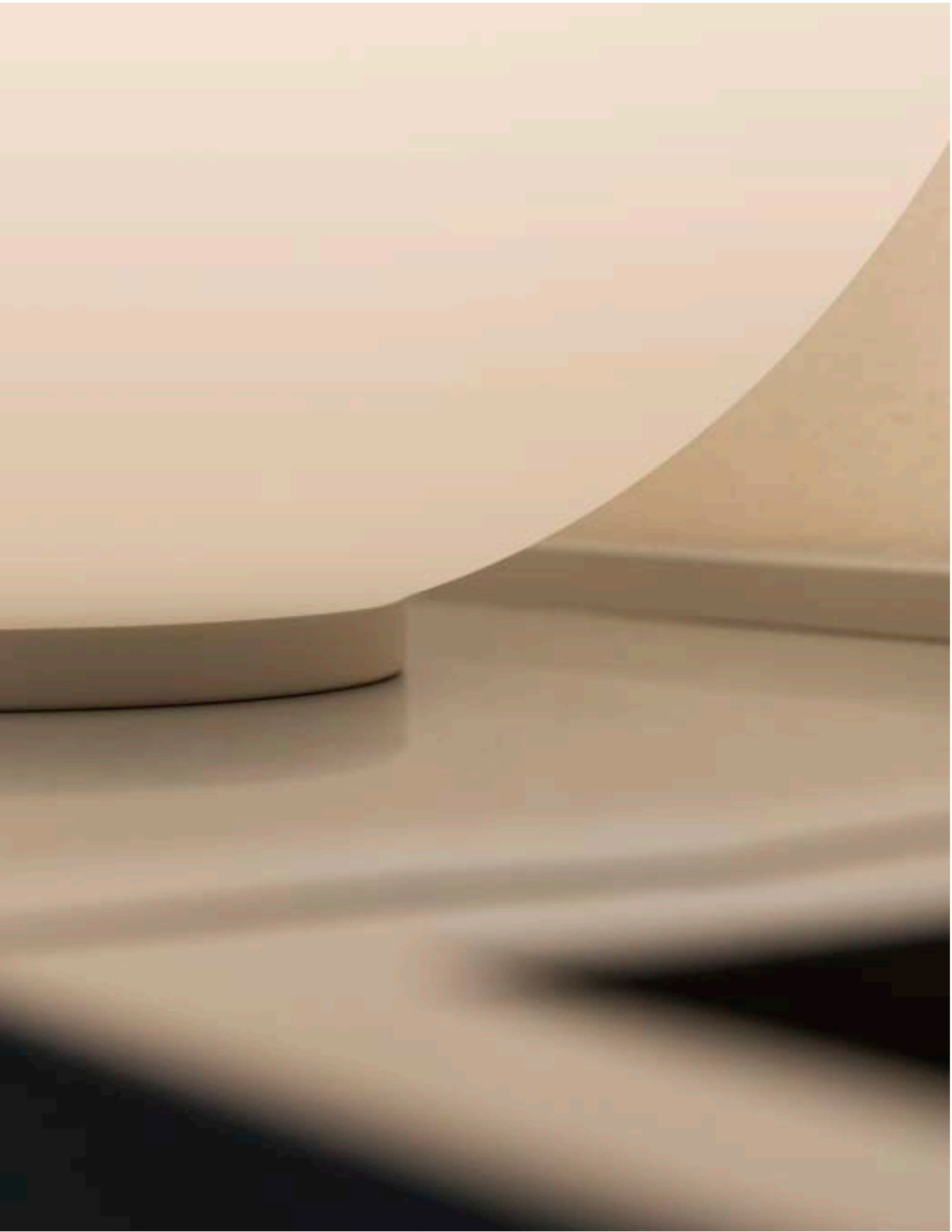
White metal base and fastening system. White blown acid-etched spherical glass diffuser.





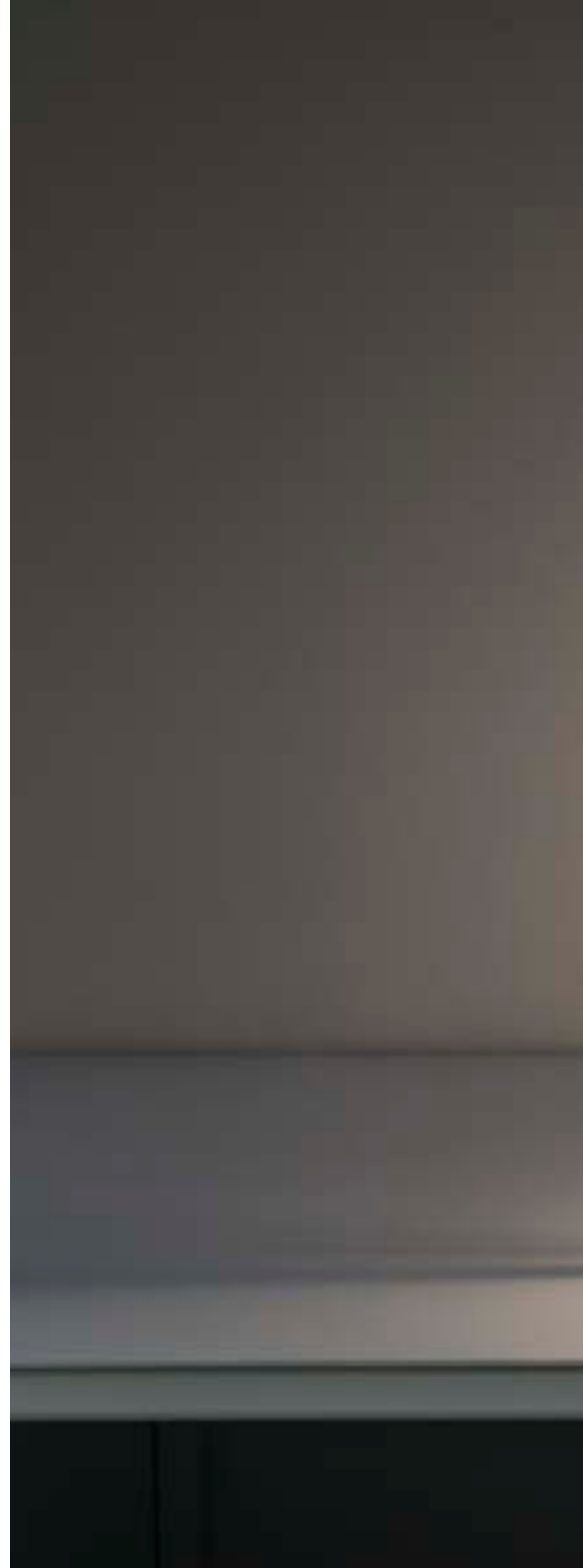






OZ

Plated or powder coated metal base and frame. PVC wires. Opal rubber diffuser. Available finishes: white, black or brushed brass.

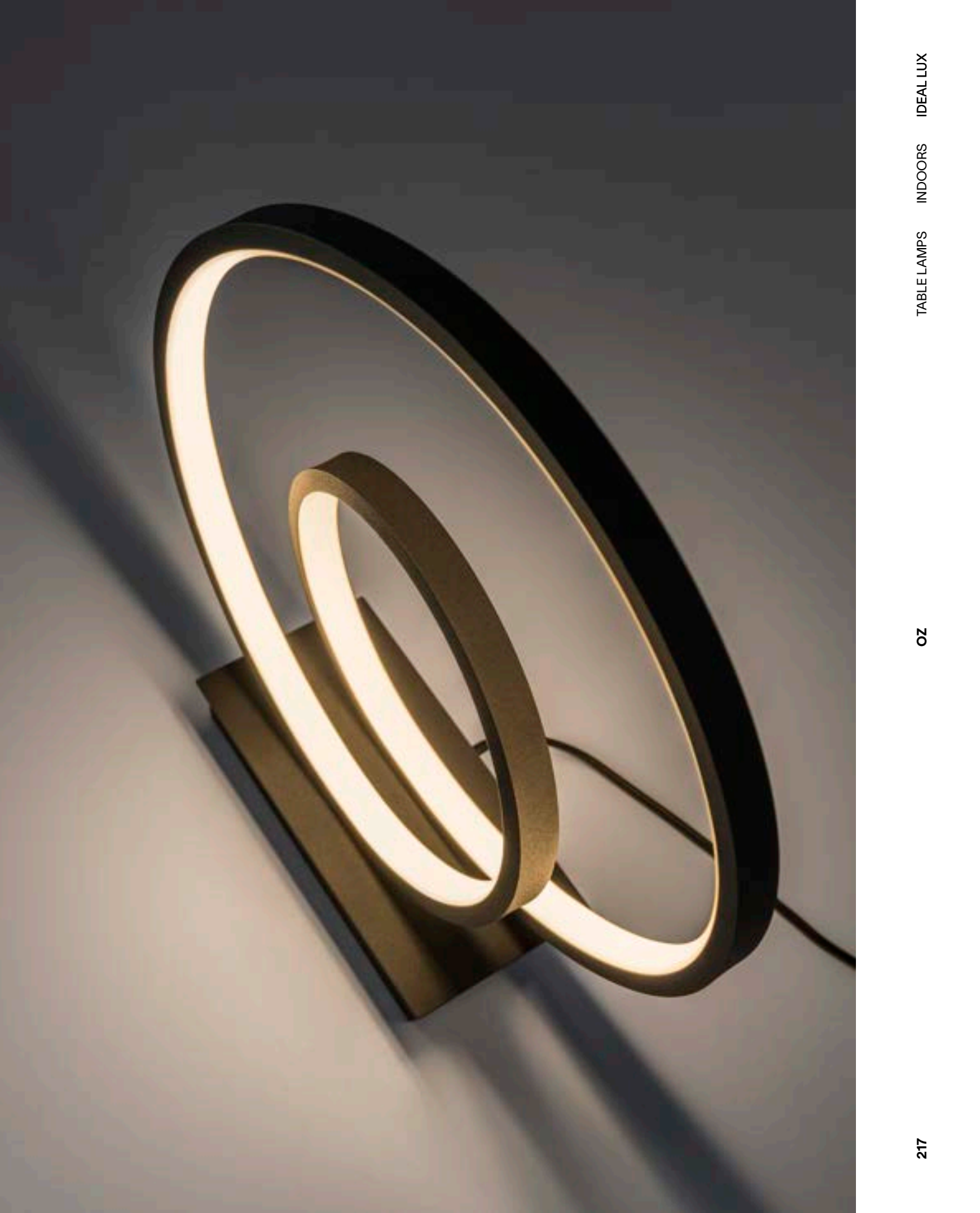


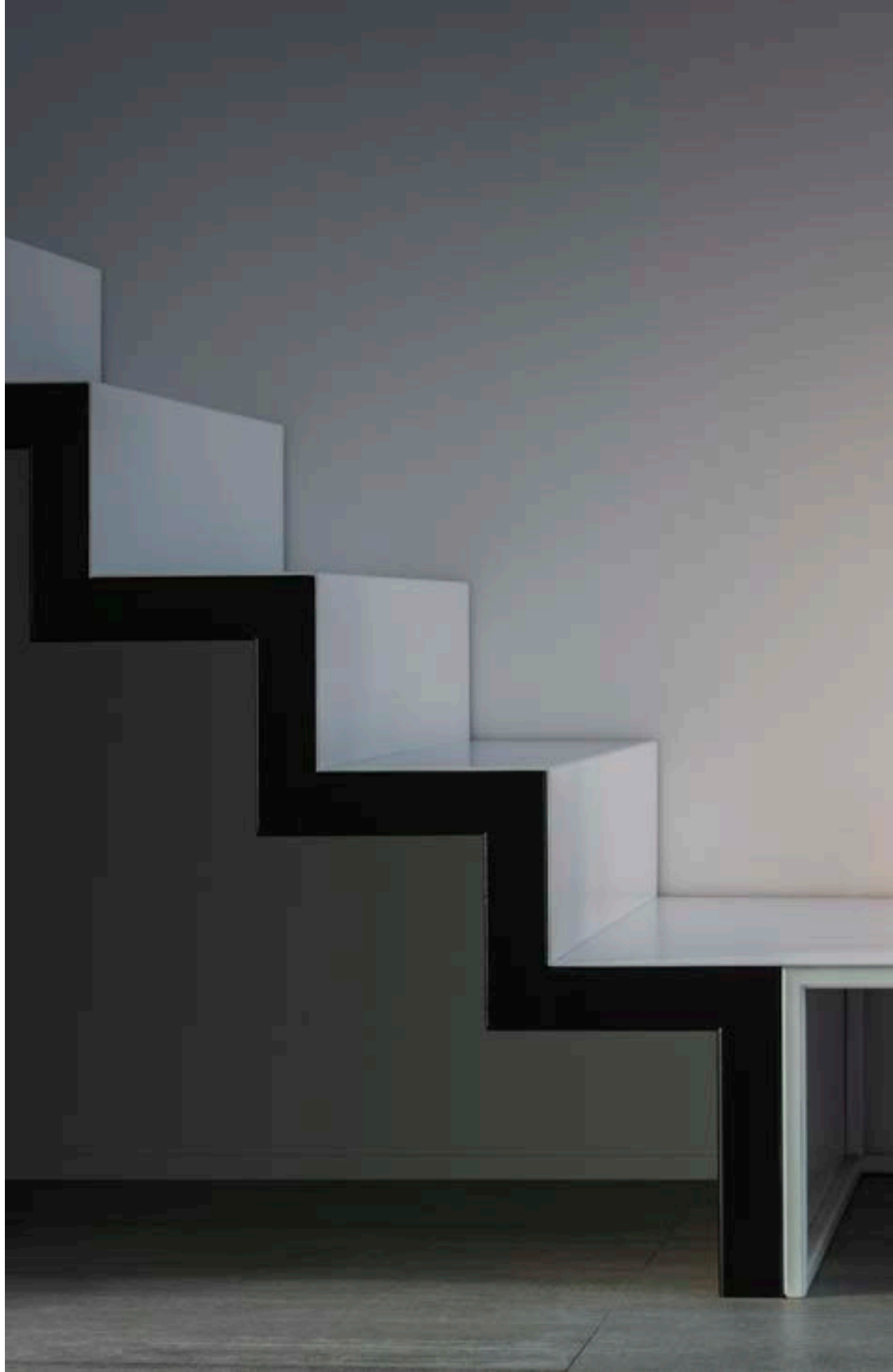










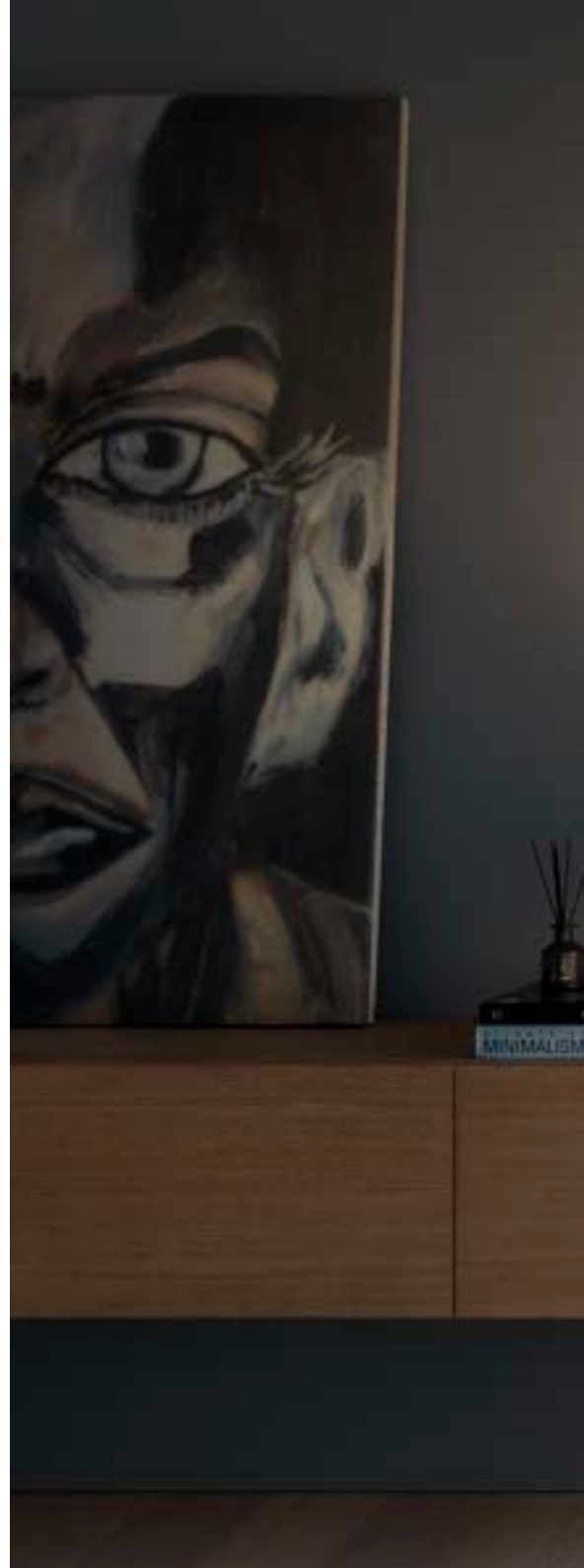




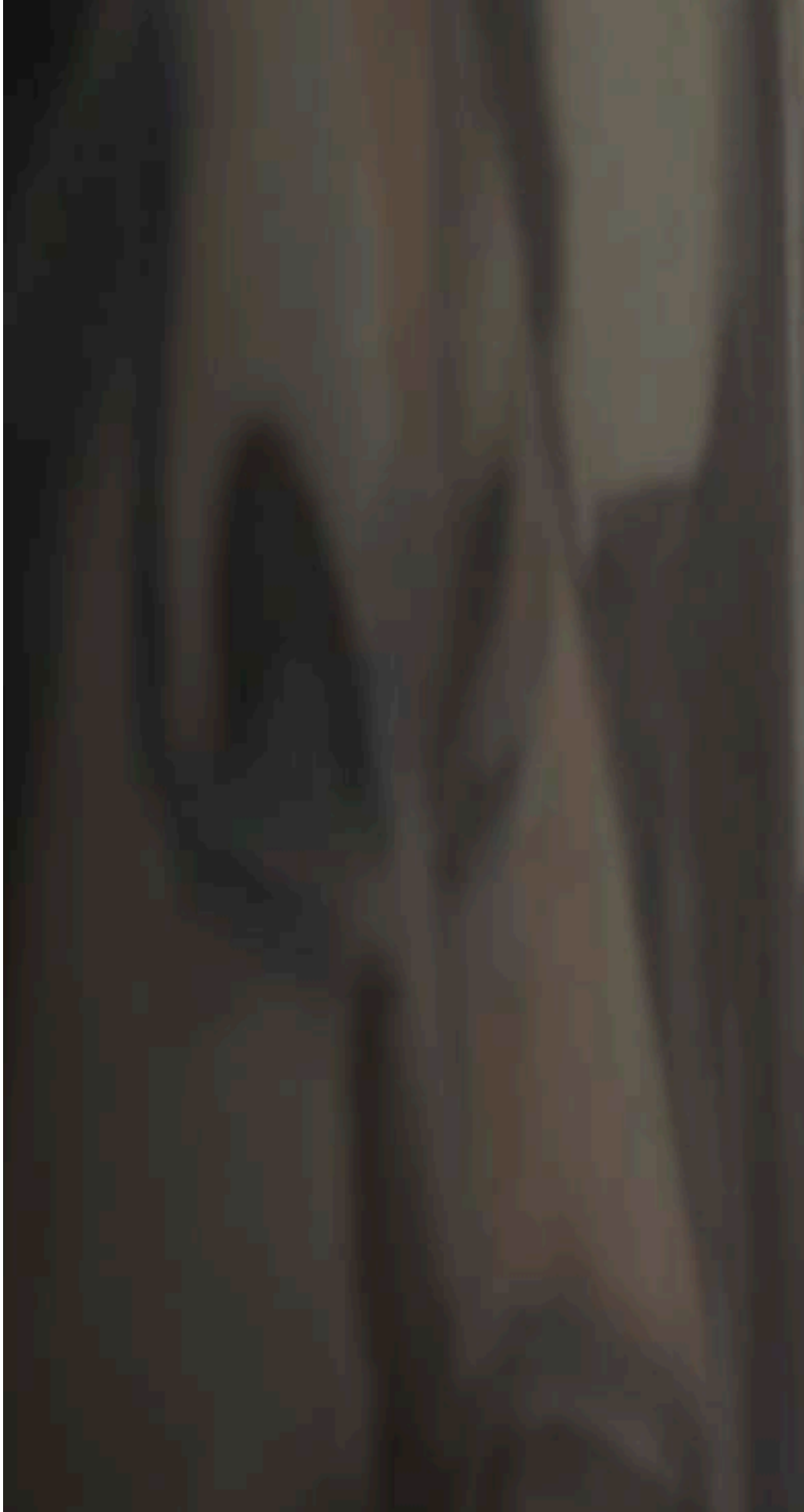


SET UP

Powder coated or plated metal frame. Lampshades made of fireproof PVC covered with fabric. PVC cable. Frame colors: white, black, satin nickel or brushed brass. Lampshade colors: beige, white, black, dove grey, wood.













FLOOR LAMPS

STEPS
RESOUNDING,
HOME
AWAITING.
LIGHT
EMBRACING.
CALMNESS
SPREADING,
REST
BECOMING FAMILIAR,
MEMORIES
DANCING
IN THE AIR.





Index



228 **Birds**
234 **Diesis**
242 **Dorsale**
248 **Equinoxe**
254 **Filo**
260 **Perlage**
266 **Set Up**

DATASHEETS ONLY
495 **Ego**
507 **Frame**
508 **Futura**
511 **Look**
516 **Mix Up**



BIRDS

Varnished metal frame with satin brass decorative disc. White acid-etched blown glass diffusers. PVC cable with switch and plug. Color: matt black with satin brass detail.













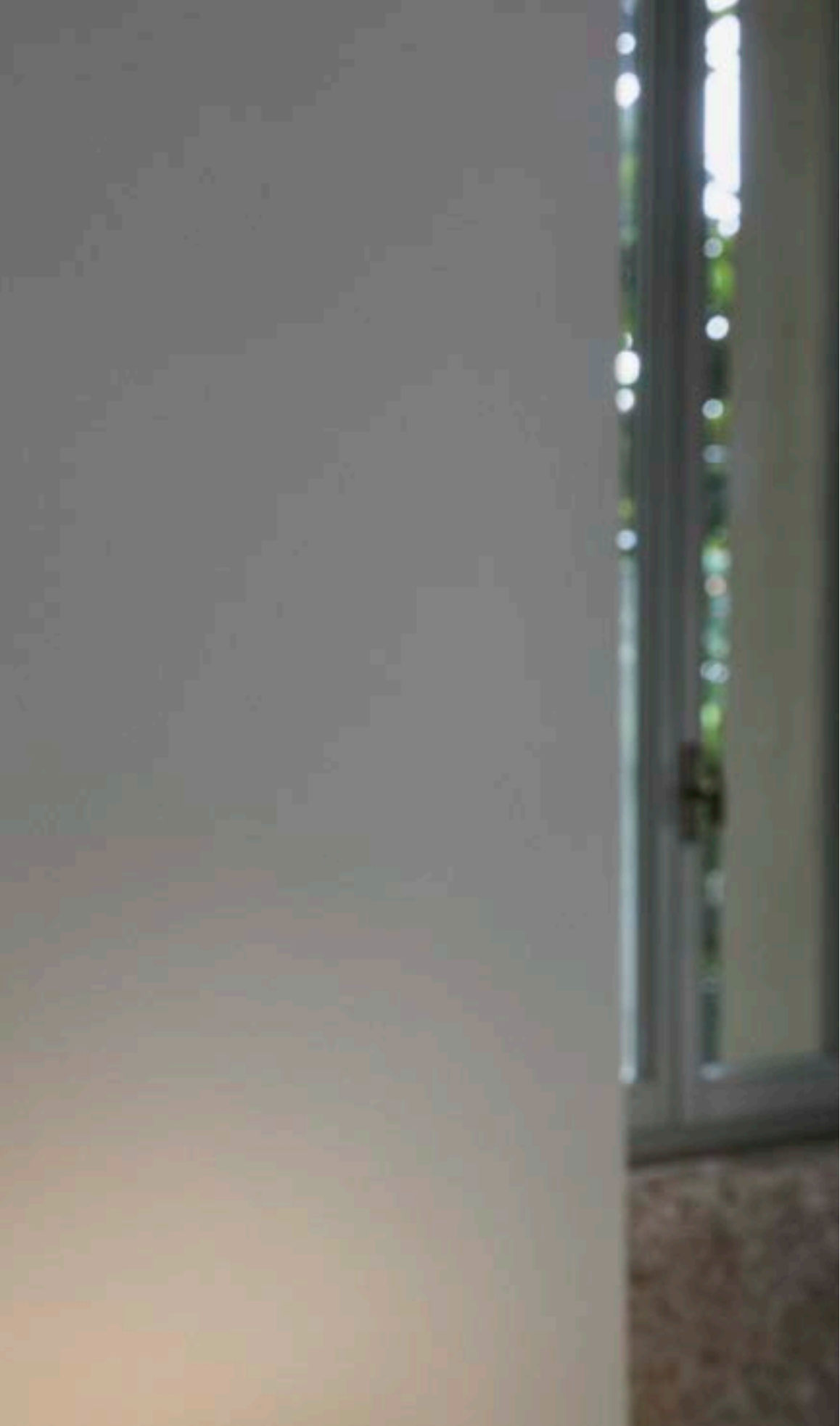


DIESIS

Powder coated or plated metal frame. Adjustable diffuser: it can be rotated or inclined. PVC cable with switch. Color: black, satin nickel or satin brass.

















DORSALE

Metal frame with chrome or white or black matt varnish finish. The arm is composed of three elements with square section. PVC foil shade, available in chrome or coated with white or black fabric.















EQUINOXE

Plated metal structure. Clear borosilicate glass diffusers. Black PVC cable. Colors: chrome structure with clear or faded smoky glass, antique brass structure with clear glass or faded amber glass.











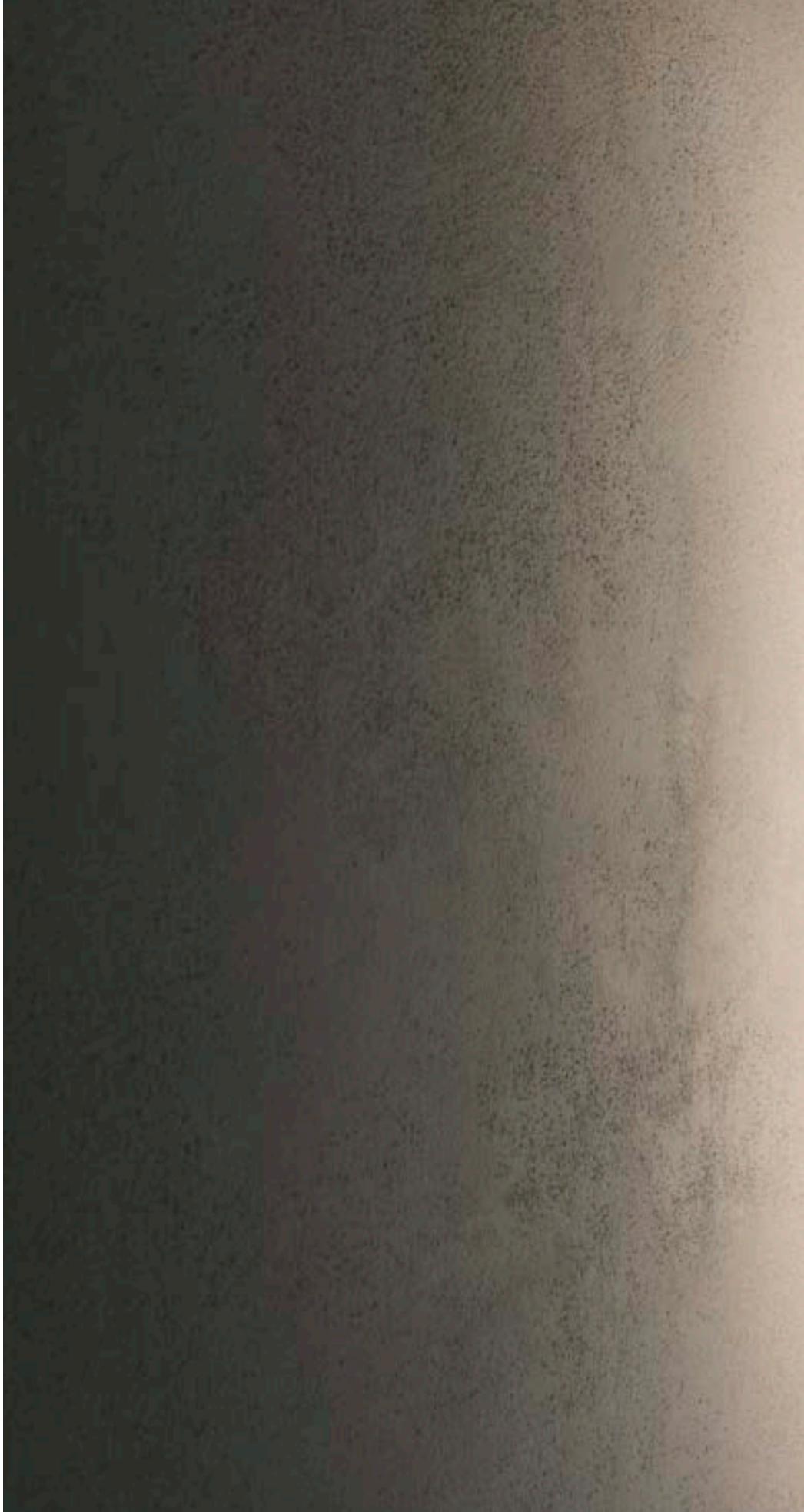




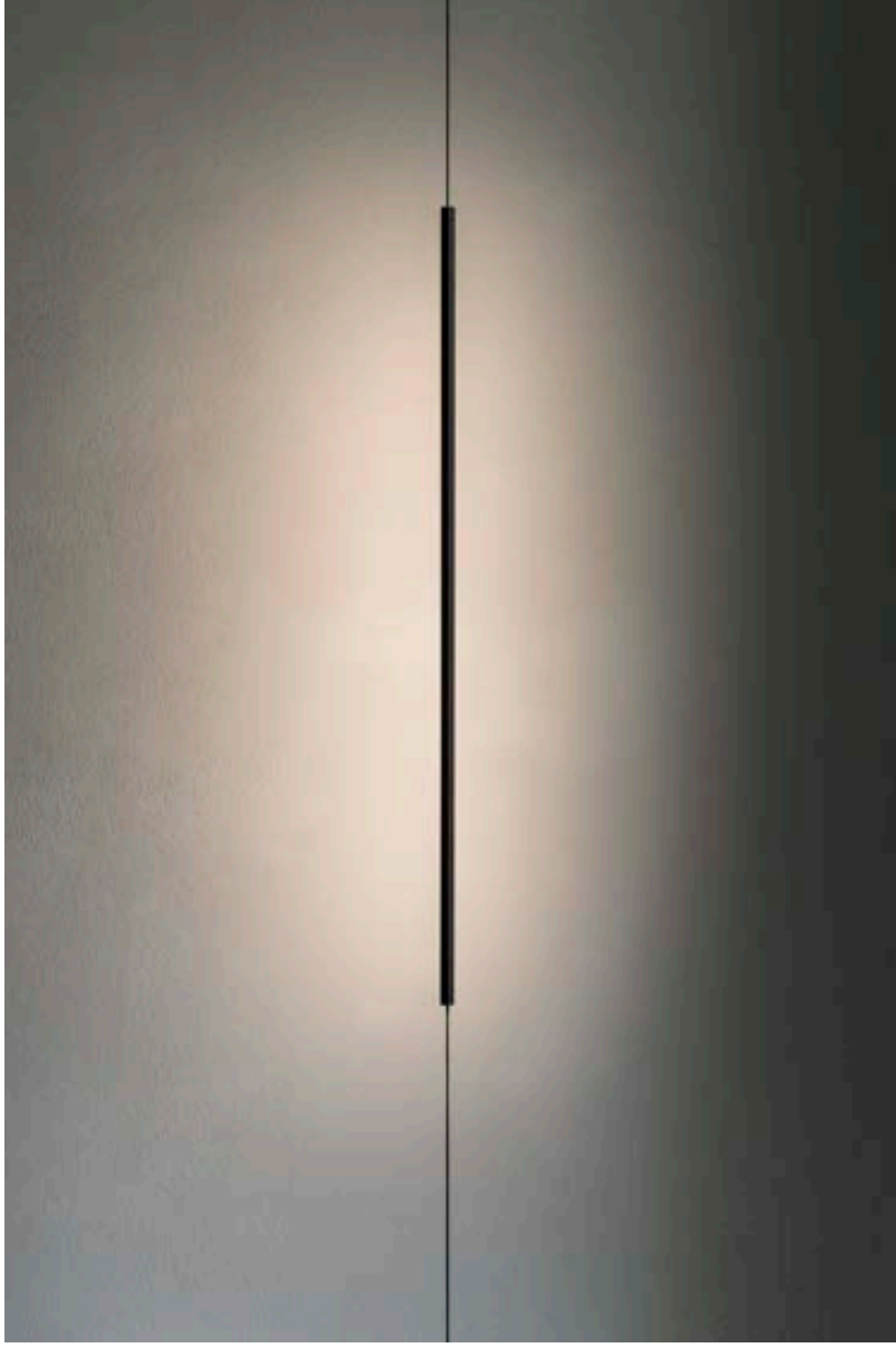
FILO

Plated or powder-coated metal ceiling cap, body and floor base.
Satin opal color PVC diffuser.
Black PVC supporting cable.
Powered from base by a black PVC cable with plug. Available finishes: white, black or brass.













PERLAGE

Metal frame. Blown glass diffusers.
Finishes: Matt black with amber or
smoky Pyrex glasses or satin brass
with etched white glasses.













SET UP

Powder coated or plated metal frame. Lampshades made of fireproof PVC covered with fabric. PVC cable. Frame colors: white, black, satin nickel or brushed brass. Lampshade colors: beige, white, black, dove grey, wood.







SYSTEMS, SPOTLIGHTS AND TRACKS

OPEN BOOK,
LIGHT
THAT SETS,
PAGES
FLYING,
WORDS
EXPANDING,
OUTLINES
BEING DRAWN,
EYES THAT
SETTLE,
MIND THAT
OPENS,
SOUL THAT
FREES.





Index



272 **Deva**
278 **Display**
286 **Ego**
306 **Eos**
314 **Fluo**
320 **Fox**
324 **Linus**
330 **Quick**
336 **Tesi**

DATASHEETS ONLY 588 **Link**
512 **Look**
604 **Spike Track**



DEVA

Linear system composed of an extruded aluminum profile and magnetic lighting fixtures. The system is available in coated or anodized matt black, ceiling or suspended installation (SURFACE), quick recessed plasterboard installation (RECESSED EASY) or edgeless recessed installation between two plasterboard panels (RECESSED). Possibility of composition with different light modules, in white or black finish depending on the desired arrangement, modifiable if necessary.















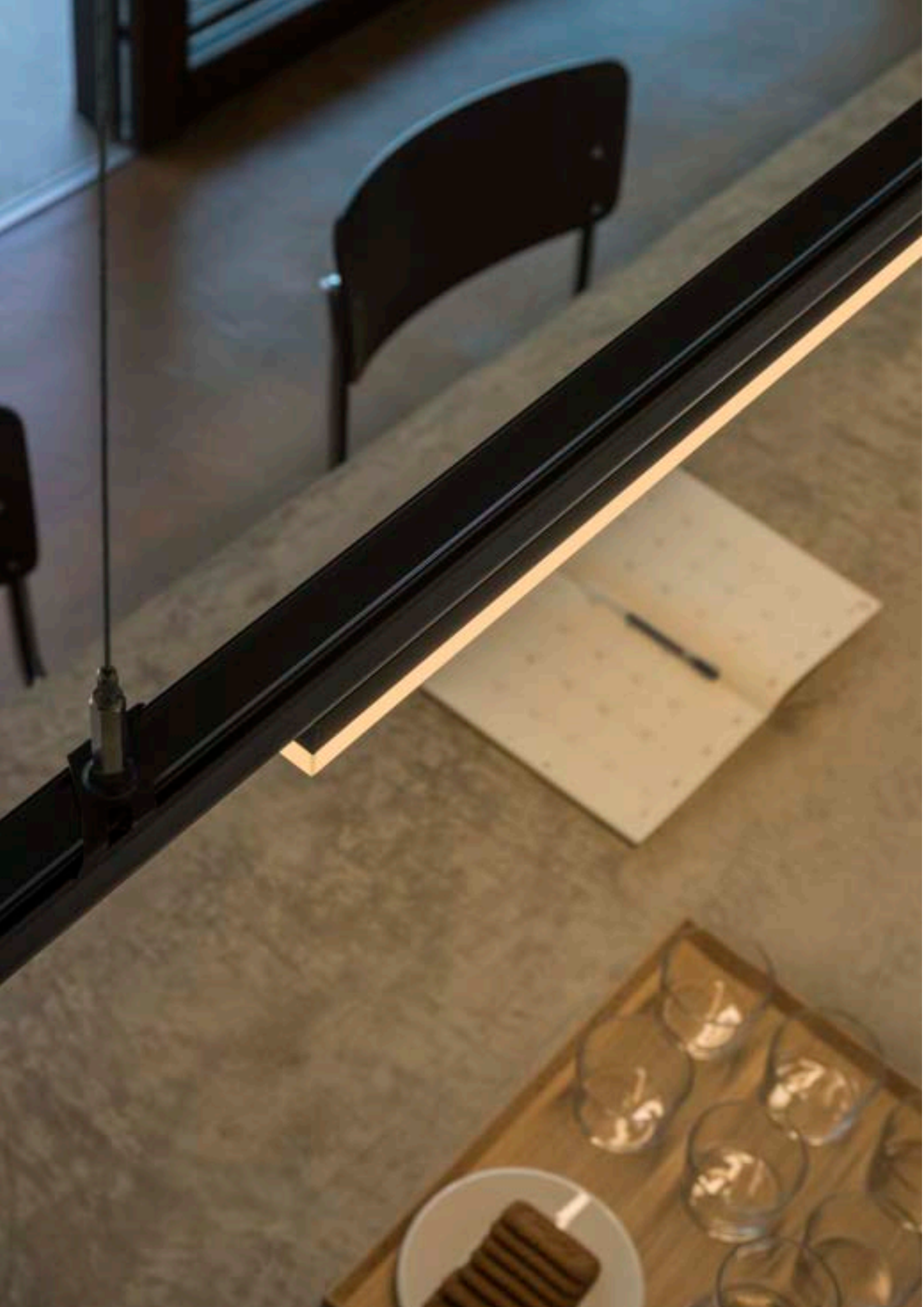
DISPLAY

Varnished aluminum linear projector for LINK three-phase track, white or black finish, PMMA diffuser. Available modules: WIDE diffusing module, microprismatized UGR module and ACCENT module (UGR < 16). The integrated power driver is located inside the track to minimize the volume of the visible product.



















EGO

Linear system composed of an extruded aluminum profile and magnetically fastened lighting elements with mechanical safety lock. The system is available in matt black RAL 9005, matt white RAL 9016 or anodized satin brass, in the ceiling or suspension installation mode (LOW and HIGH), recessed without edge that disappears into the plasterboard (RECESSED), rapid recessed into the plasterboard (RECESSED EASY) or recessed with edges for plasterboard or paneled false ceilings (RECESSED TRIM).

Possibility of composition with different light modules depending on the desired arrangement, modifiable if necessary.

Ideal for lighting small and large environments where ample flexibility and high quality lighting is required, for example museums, commercial, residential and retail spaces.





EGO
index



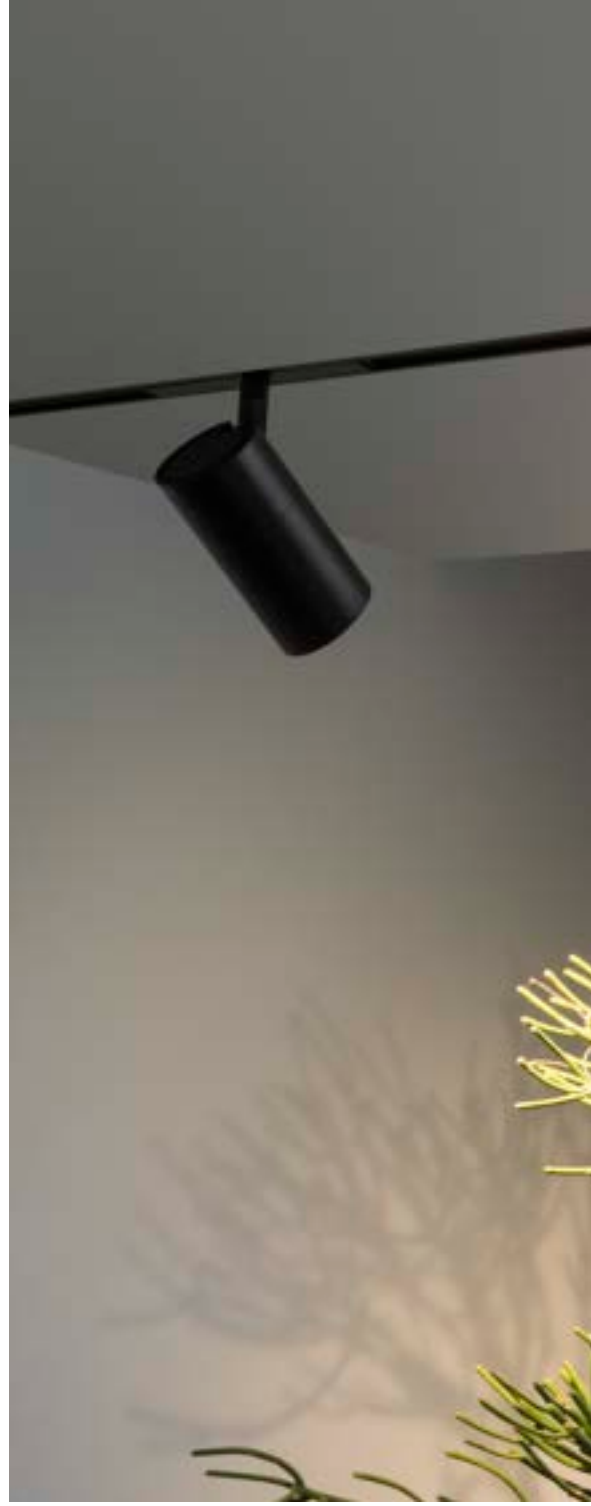
555 **Accent**
551 **Track Single**
554 **Track Flat**
556 **Wide**

DATASHEETS ONLY

568 Bi-emission
572 Drivers
558 Flexible
562 High
560 Low
559 Pendant
564 Recessed
554 Track Big
553 Track Double
555 Track Zoom

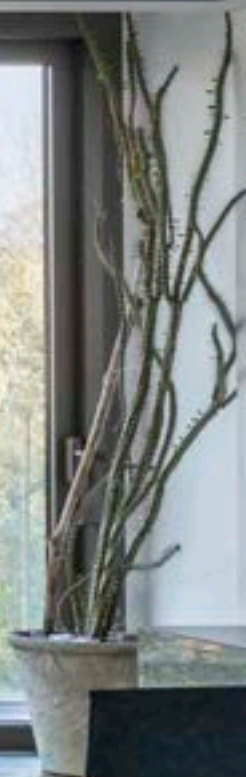


EGO Track Single

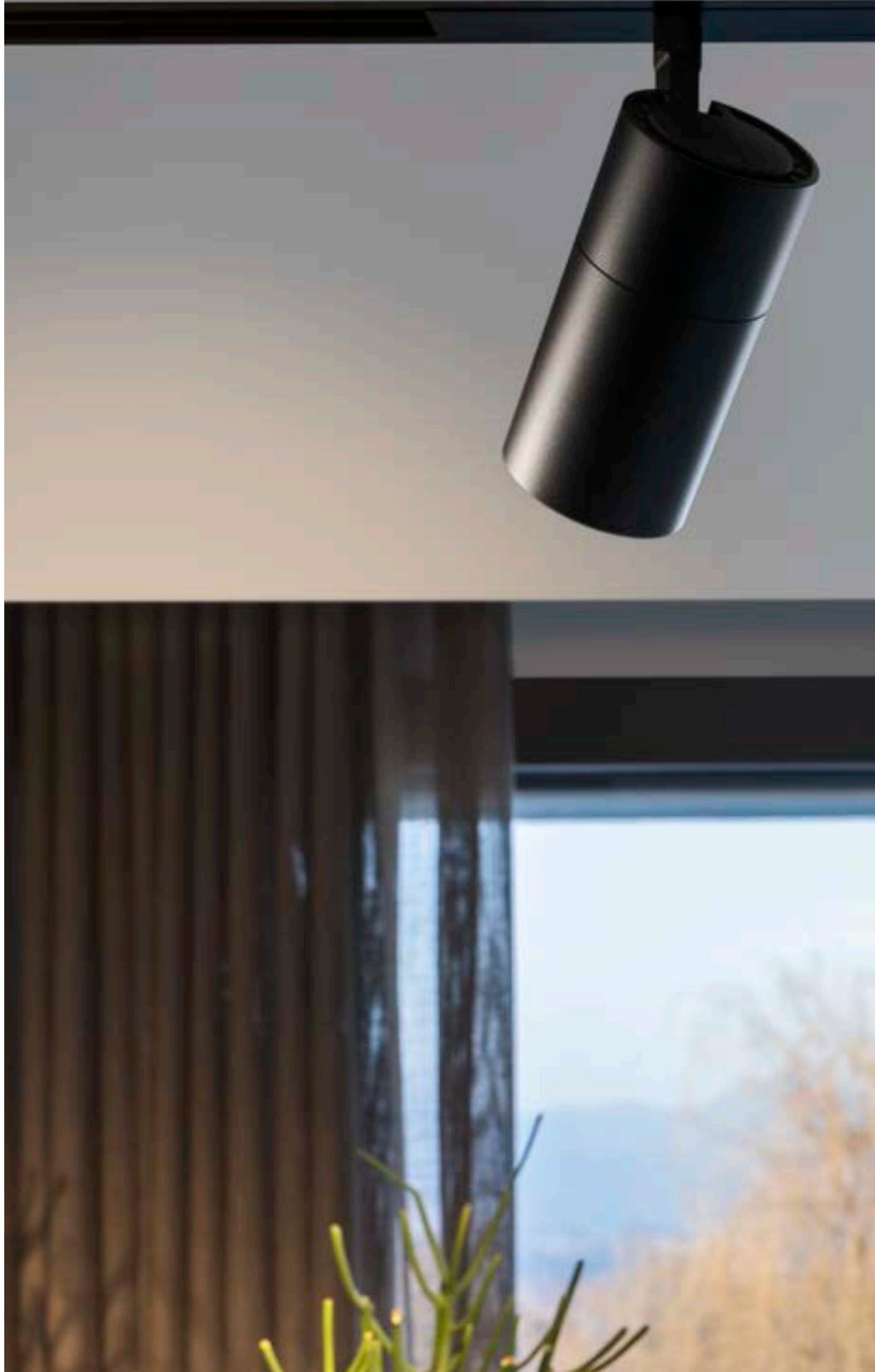


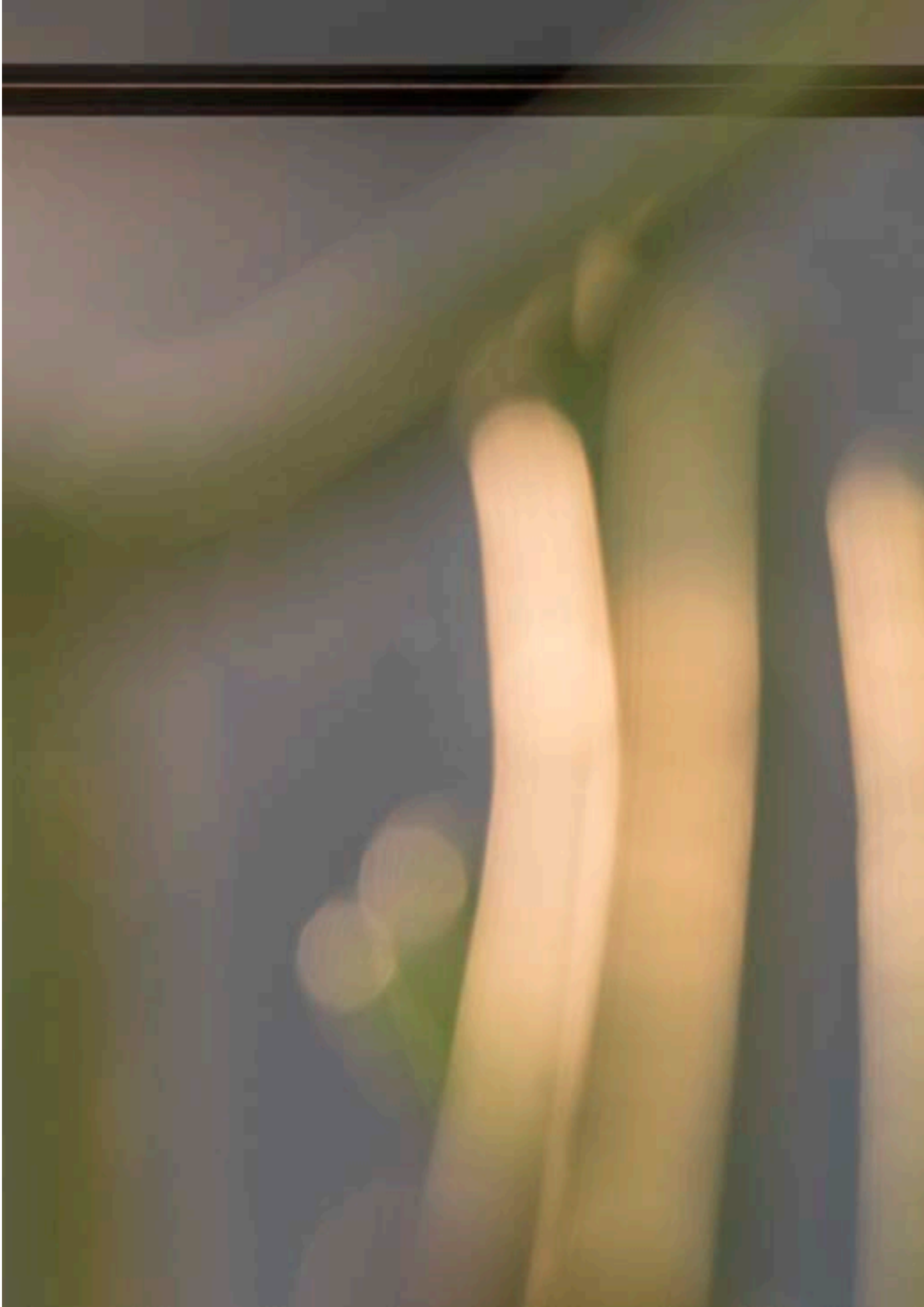












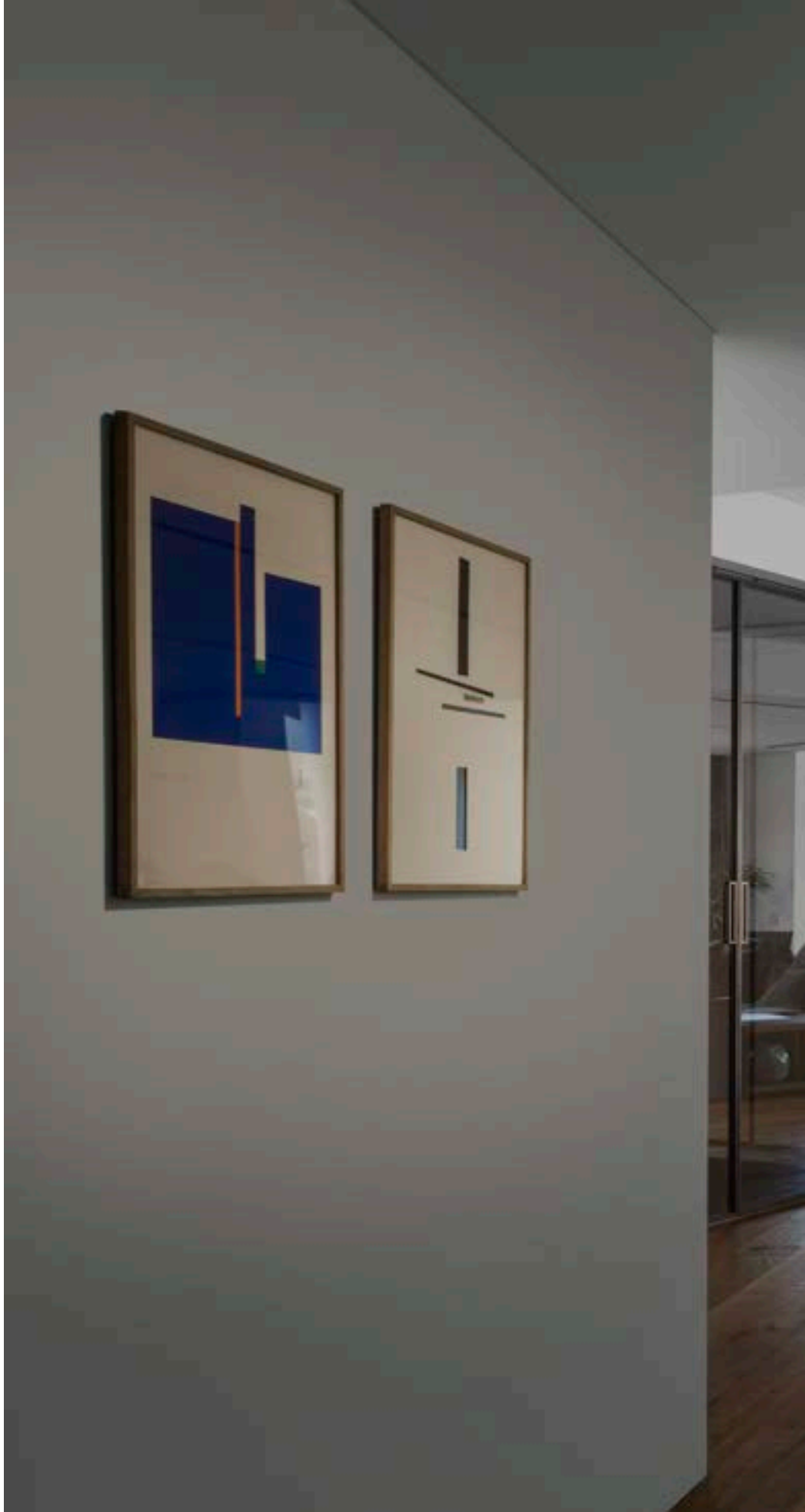




EGO Track Flat











EGO Wide













EOS

Extruded aluminum cylindrical tracklight with variable opening beam from narrow to wide (20°-55°), suitable for single-phase or three-phase LINK track installation. White or black powder coating, 355° turning head and 90° adjustable; the power driver is included and located in the cylindrical body of the projector itself. Ideal for installation in big rooms, where great flexibility and high color rendering is required, such as museum, commercial and retail spaces.

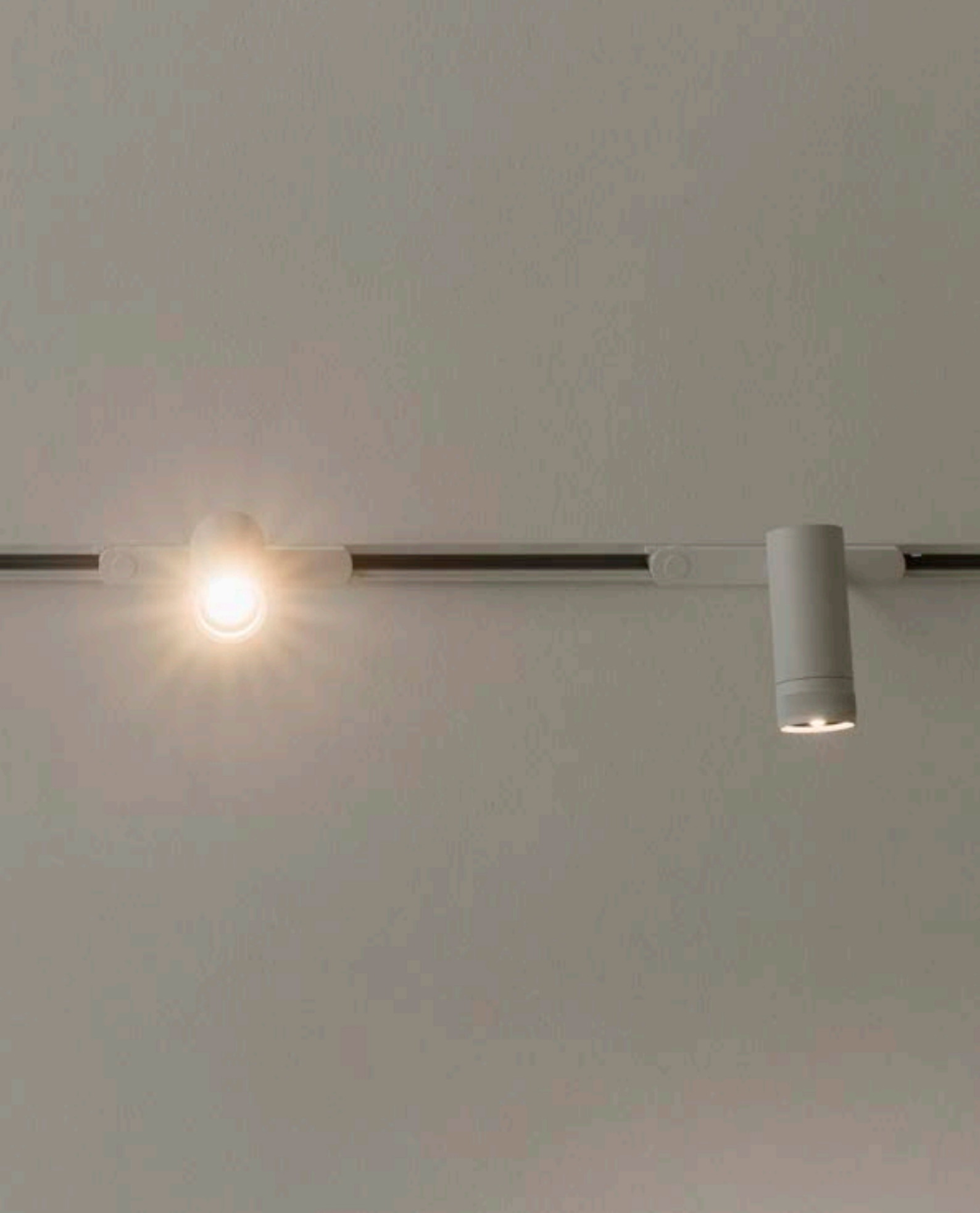


















FLUO

Linear system of lamps with extruded aluminum, 50 mm wide and 80 mm high body. Modules available in two lengths: 1200 mm and 1800 mm, which can be assembled according to the desired arrangement. The system is available in two different arrangements: the WIDE diffusing module and the BI-EMISSION module with component for indirect lighting.













FOX

Cylindrical aluminum projector suitable for installation on single-phase and three-phase LINK track. White, black or satin brass powder coating, 350° rotating head and 90° adjustable, the power driver is included and is located in the cylindrical body of the projector itself. Perfect for lighting the small and medium size environments that require wide flexibility for arrangement, where great flexibility and color rendering is required, such as commercial and retail spaces, and an optimal performance-price ratio.









LINUS

Linear aluminum lamp with direct and indirect light for wall installation. The lamp is modular and can be used individually or in a continuous line. White or black finish available.















QUICK

Extruded aluminum cylindrical tracklight suitable for installation on three-phase track. White or black powder coating, 355° turning head and 90° adjustable, the power driver is included and located in the cylindrical body of the projector itself. Ideal for installation in big rooms, where great flexibility and color rendering is required, such as museum, commercial and retail spaces.













TESI

Flexible steel tape for wall-to-wall tension application, to be used as a support for the application of LED strips for indirect lighting. Tape available in two widths of 8 mm and 20 mm, maximum length of 5 or 10 meters that can be cut to size, aluminum supports with locking system, available in steel, white or black finishes. Ideal for environments with an historical and architectural character that are already highly personalized, with its minimal section it disappears inside the environment to guarantee a result of extreme formal cleanliness.





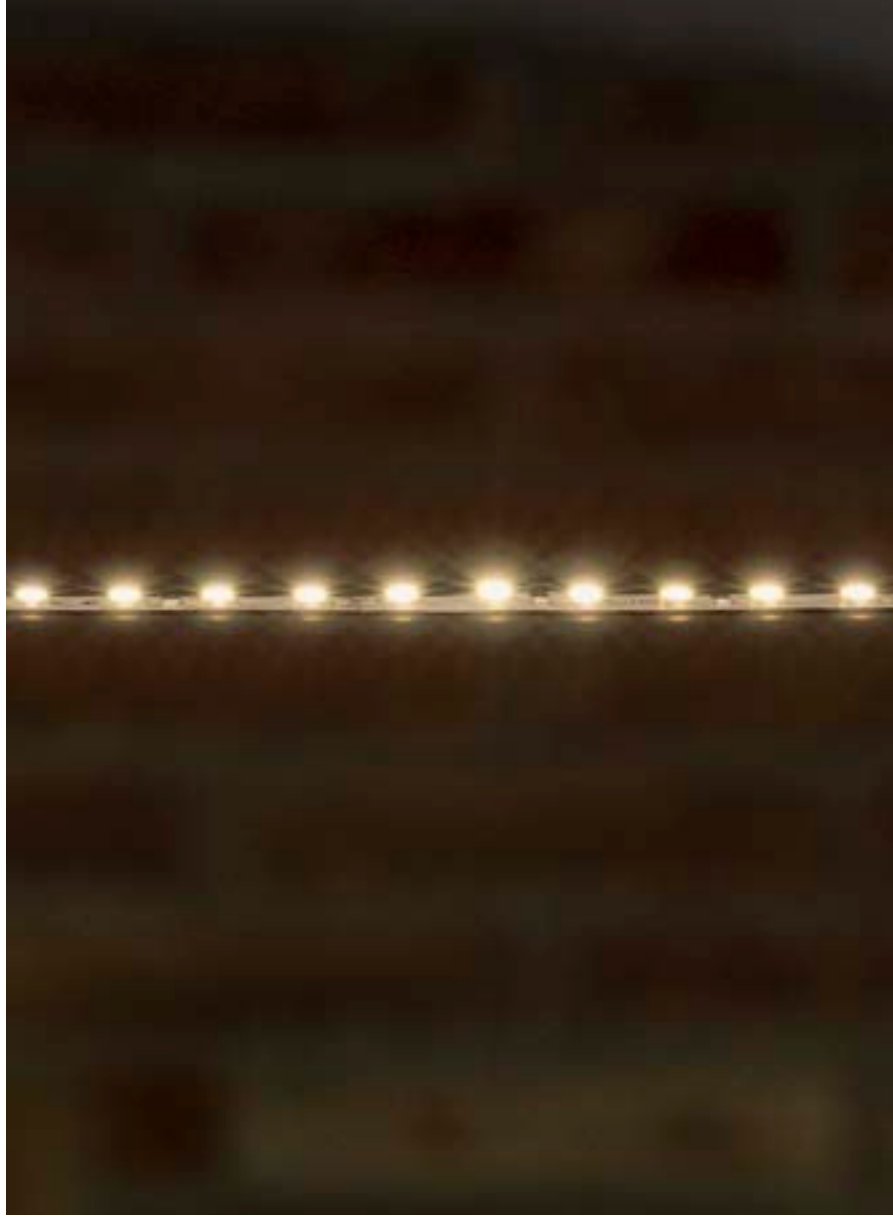


TESI

SYSTEMS, SPOTLIGHTS AND TRACKS

INDOORS

IDEAL LUX





RECESSED LIGHTS

DRAWN CURTAINS,
LAMPS
THAT DIM,
CRISP
MORNING,
PEACEFUL
GARDEN.
WAKING UP
IN HARMONY,
MIST THAT
DISSIPATES,
QUIETNESS
THAT EMBRACES,
IN THE DAWN
THAT SETTLES.





Index

↳

342 **Game**
348 **Lika**
352 **Nova**
358 **Virus**
362 **Zeus**



GAME

Die-cast aluminum recessed spotlight with round or square ring, suitable for installation on plasterboard or paneled ceilings. Available finishes: matt silver, matt white RAL 9001, matt black RAL 9011 and matt gold RAL 1032. Available versions: with external frame (TRIM), retractable without frame for plasterboard (TRIMLESS), or with frame and improved frontal protection (IP65).















LIKA

Rectangular recessed projector in painted die-cast aluminum, with recessed light sources, available in the TRIM version with edge and TRIMLESS version without edge, with shiny black polycarbonate reflector, and SLIM version with reduced dimensions.









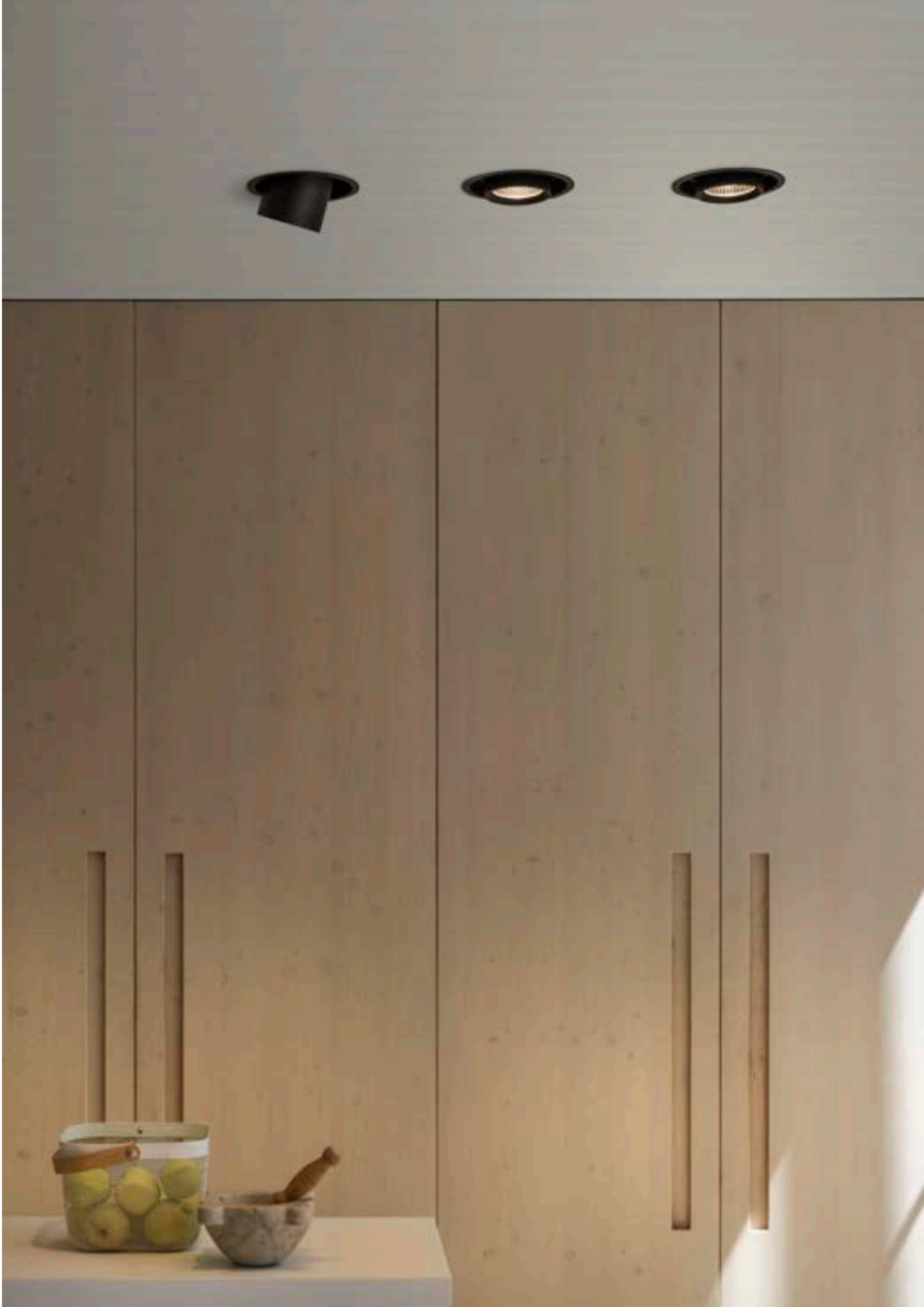
NOVA

Die-cast aluminum recessed projector with round ring, suitable for installation on plasterboard ceilings. Source adjustable 360° and extractable up to 90° in relation to the vertical axis. Matt white or matt black finish.













VIRUS

Recessed aluminum mini-spotlight with round ring, suitable for installation on plasterboard or paneled ceilings. Matt white, matt black, matt gold finish. SMD LED technology; available in 3000K color temperature; CRI \geq 90; IP20 protection; insulation class II; LED useful life 30,000 h L70B50. The high color rendering and small dimensions make it ideal for accent lighting in recesses and shop windows in domestic and retail interior environments.











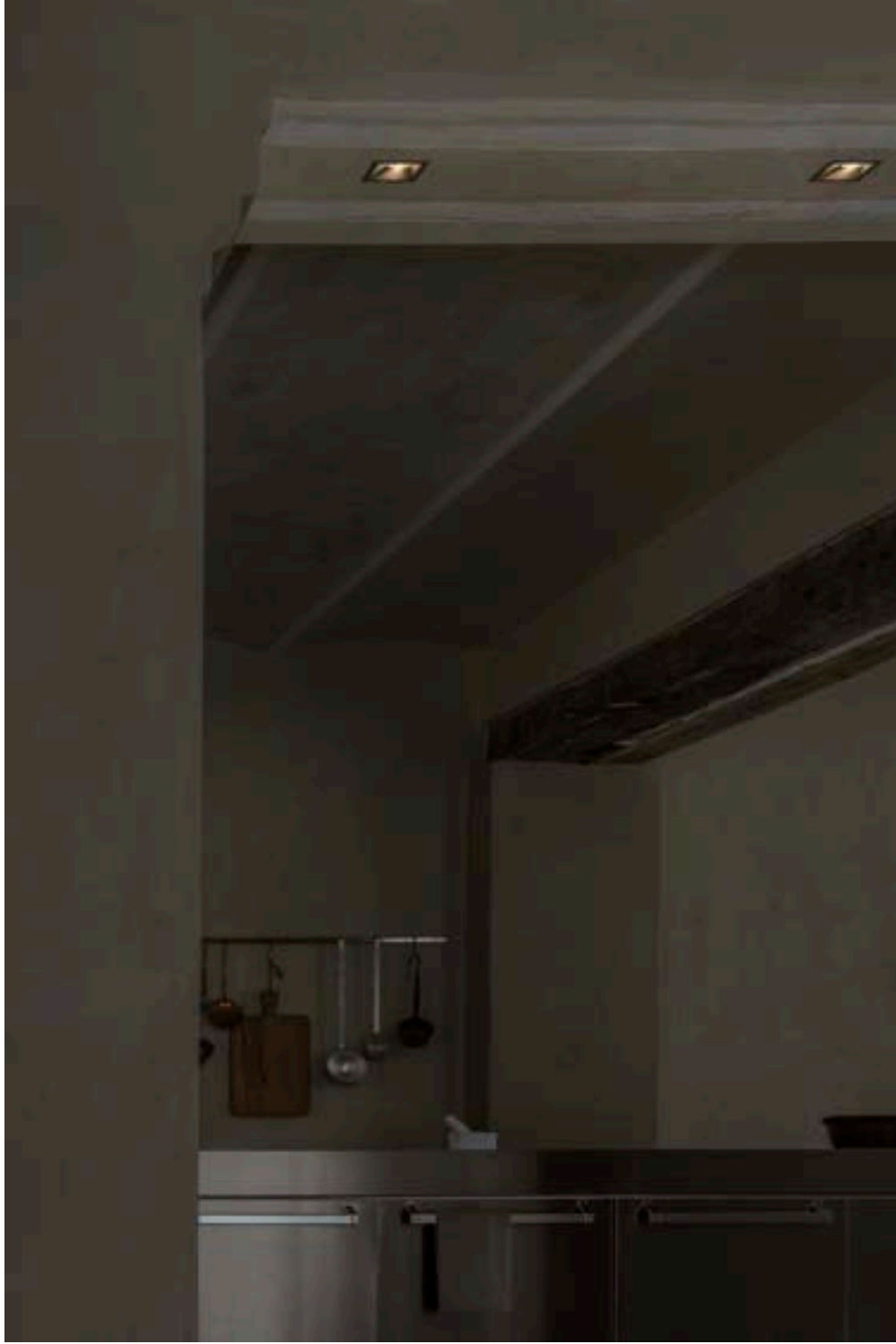
ZEUS

Modular system of recessed elements consisting of an adjustable source, reflector and round or square ring, with optional shielding lenses and accessories; white and black finish; ring available in TRIM version with frame or TRIMLESS without frame for installation in plasterboard false ceilings; two different emission angles to choose from.





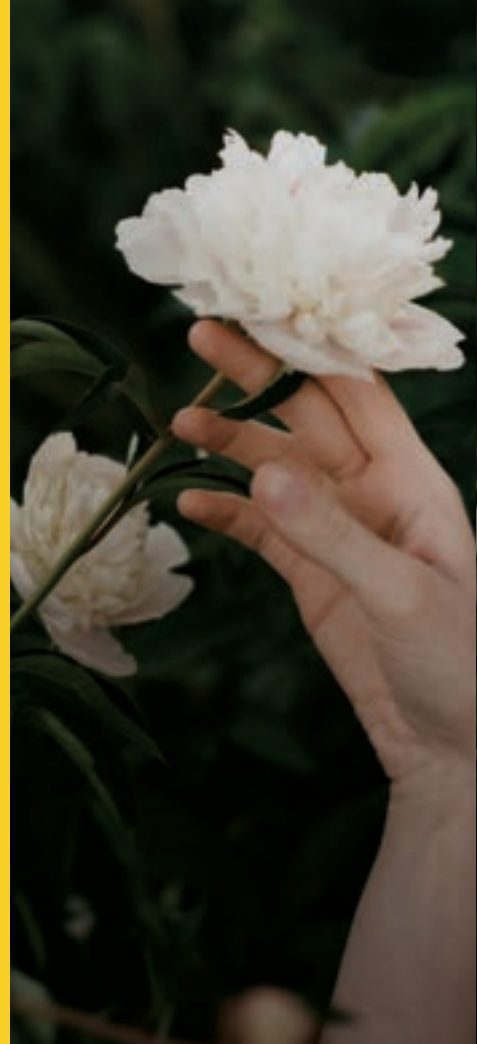






OUTDOOR LAMPS

FRAGRANCE
OF FLOWERS
REFLECTING
IN THE POOL,
THE SUN
GOING DOWN,
THE GARDEN
LIGHTING UP.
DANCING LIGHTS,
SETTING UP
THE EVENING'S
SCENE.
GLASSES
CLINKING,
GETTING READY
FOR DINNER.





Index



370	Agos	430	Sole
378	Andromeda	436	Starlight
382	Atom	442	Style
388	Gun	448	Swipe
396	Jedi	454	Taurus
402	Linea	460	Techo
406	Lolita	466	Tesla
414	Punto	472	Vega
418	Pure		
422	Sirio		



AGOS

Powder coated die-cast aluminum body. Satin transparent acrylic diffuser. Colors: anthracite or coffee.



















ANDROMEDA

Die-cast aluminum body light with varnish finish. Double frosted Pyrex glass, up-and-down. Available finishes: anthracite, white, coffee, grey or black.









ATOM

Powder coated aluminum body.
Glass diffusers. Double light beam,
up and down with adjustable width
and movable wings.















GUN

Aluminum body with brushed natural finish or with varnish or various finishes. Pyrex glass diffuser.



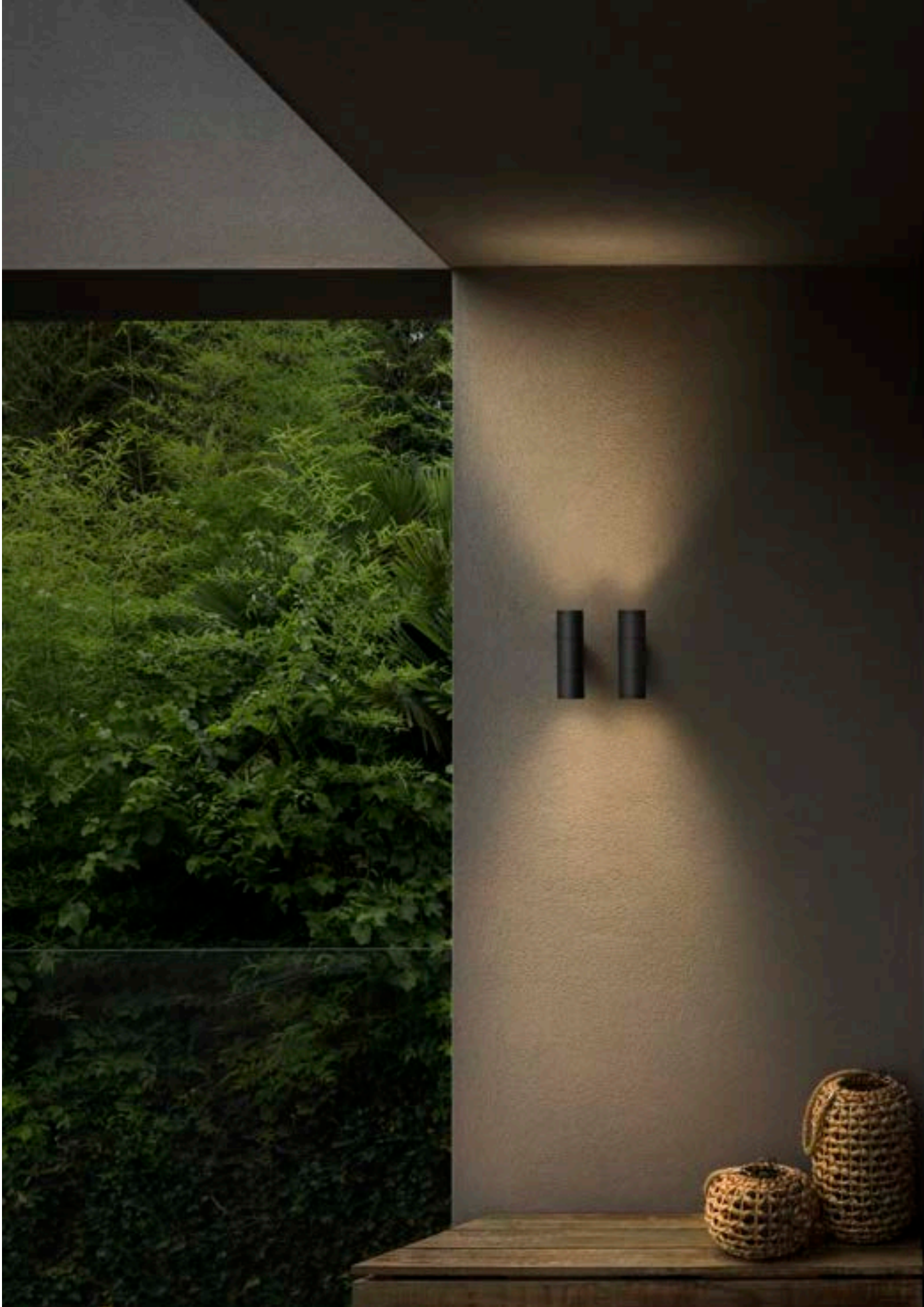














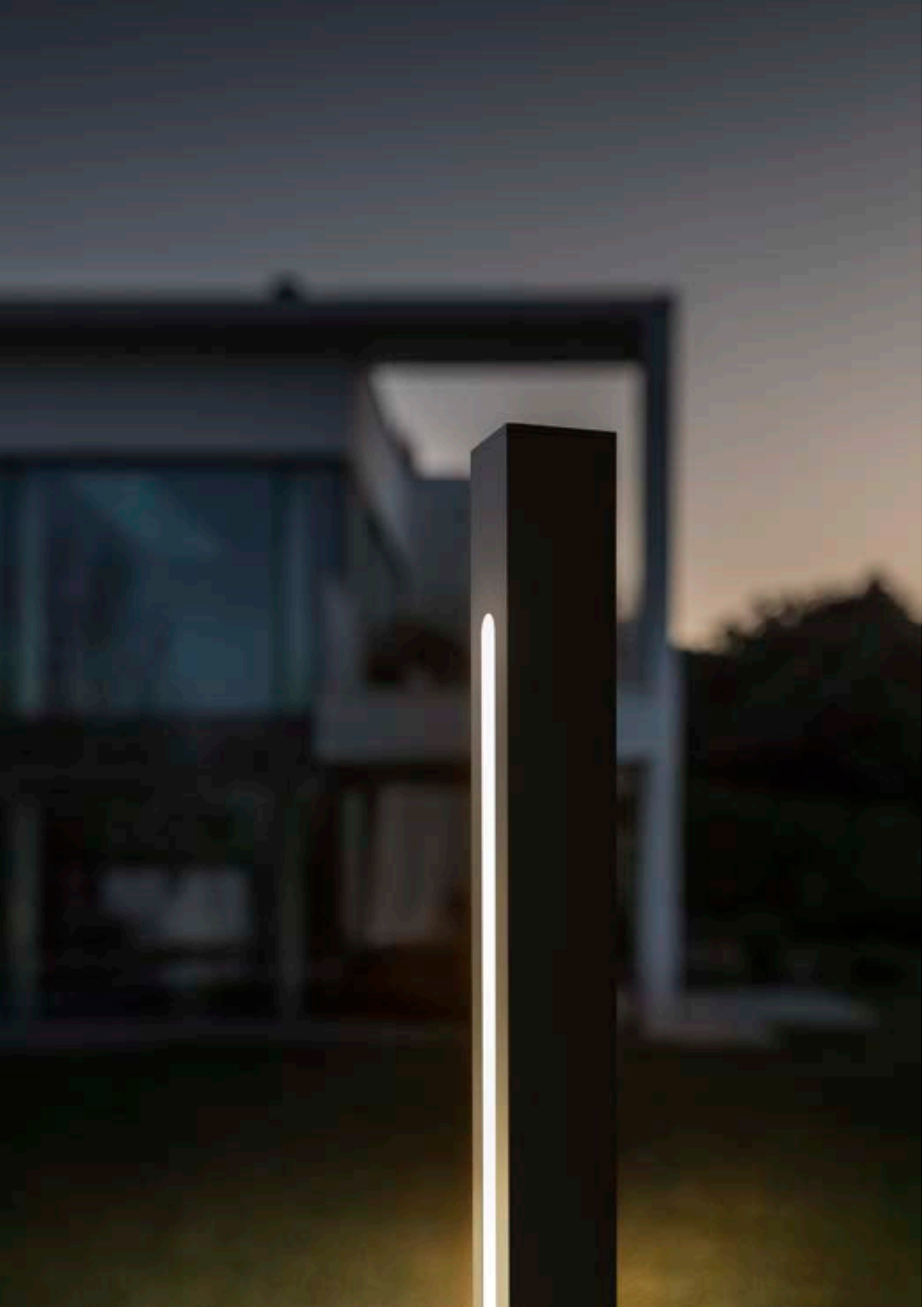


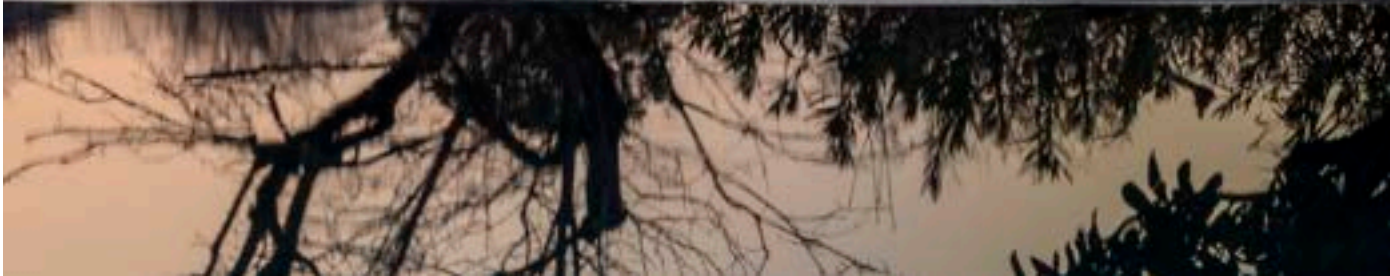
JEDI

Powder-coated aluminium base and body. Shiny opal color polycarbonate diffuser. Supplied with piquet for ground installation. Available finishes: anthracite or black.













LINEA

Powder coated aluminum base and body. Glass diffusers. Indirect light emission. Finishes: anthracite, white, coffee, black.









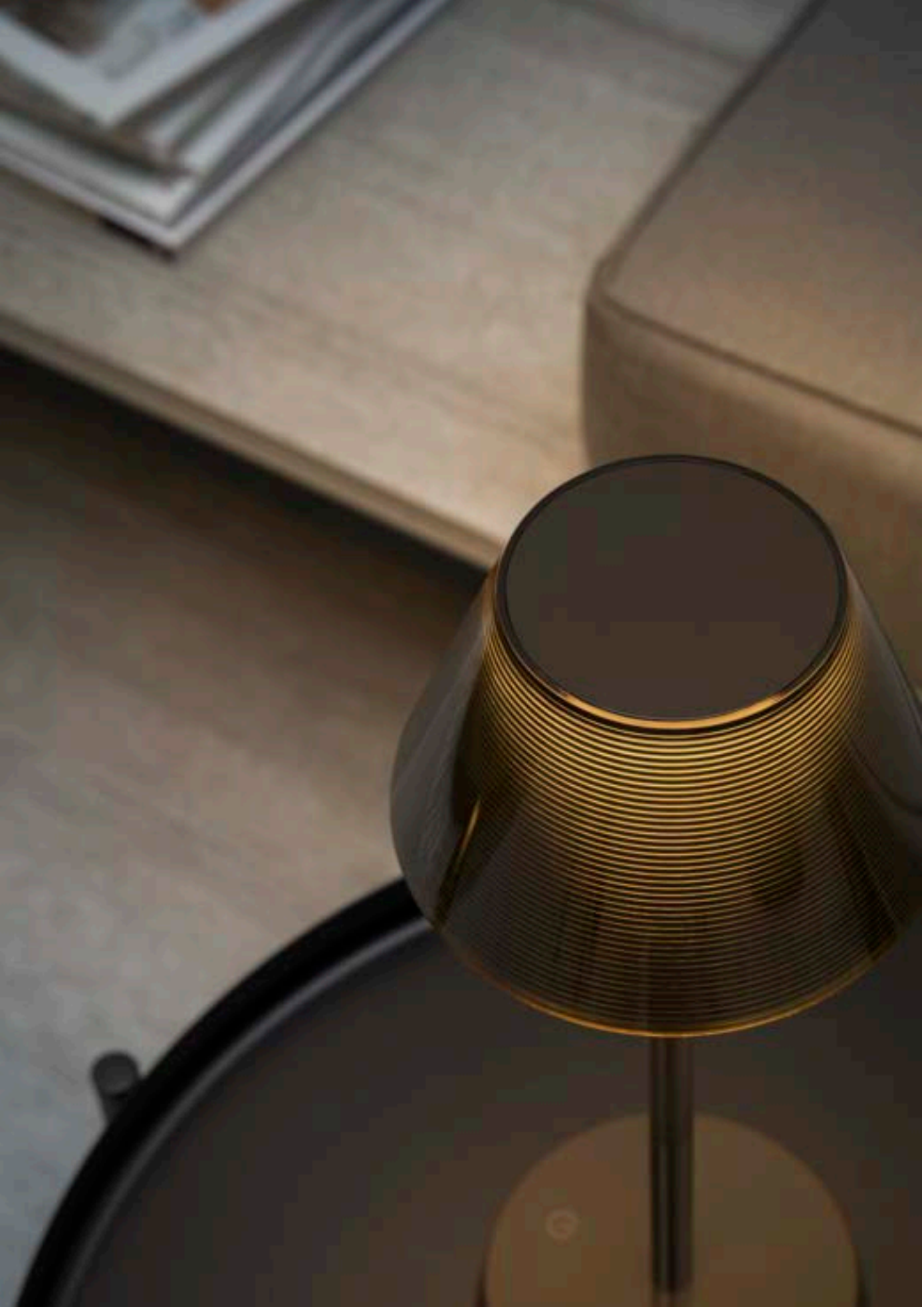


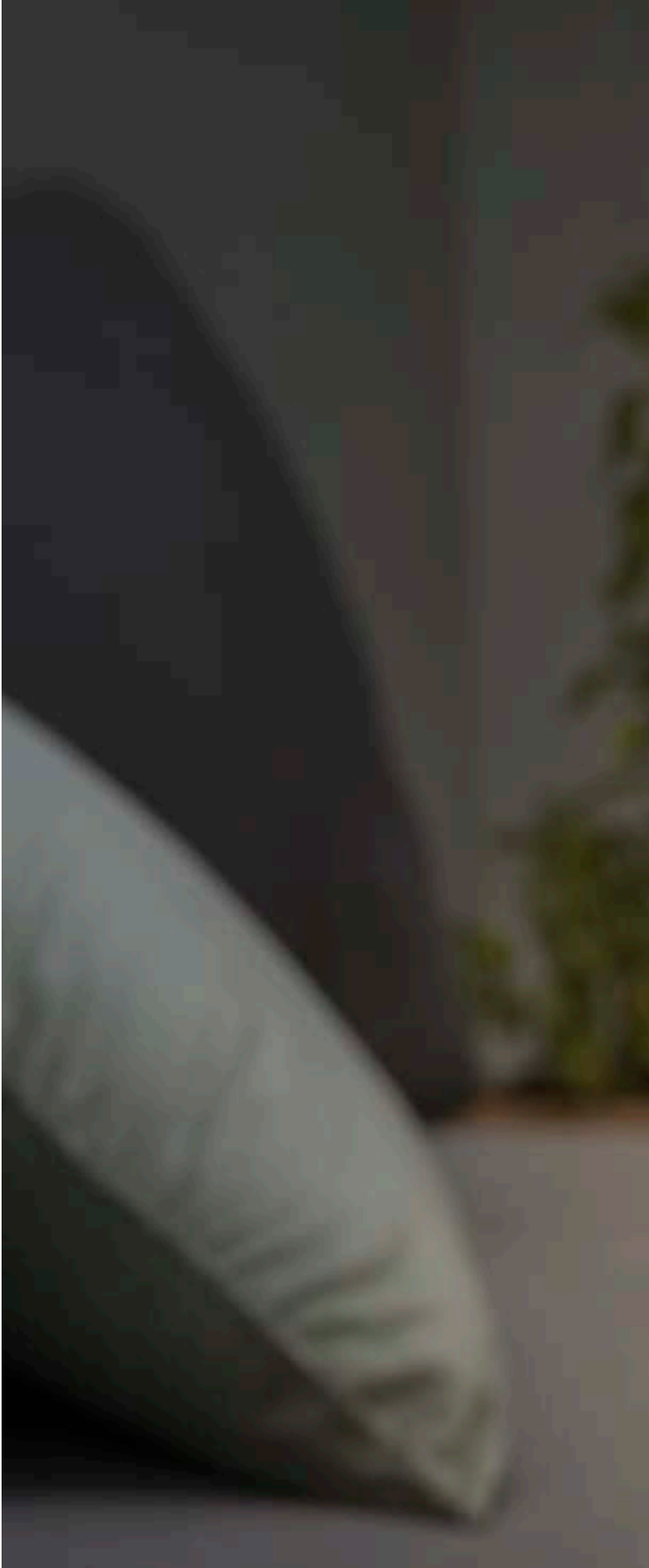
LOLITA

Table lamp with rechargeable battery with white, grey, black or coffee finish. Plastic base. Metal frame. Plastic diffuser. The table lamp has 14 hours autonomy. Battery charging time 7 hours.

















PUNTO

Powder coated aluminum base and body. Glass diffusers. Indirect light emission. Finishes: anthracite, white, coffee, black.











PURE

Matt varnished metal base, stem and shade. Acrylic diffuser. Table lamp with rechargeable battery and integrated touch switch. Finishes: white, coffee, black. Battery charging time 6 hours.









SIRIO

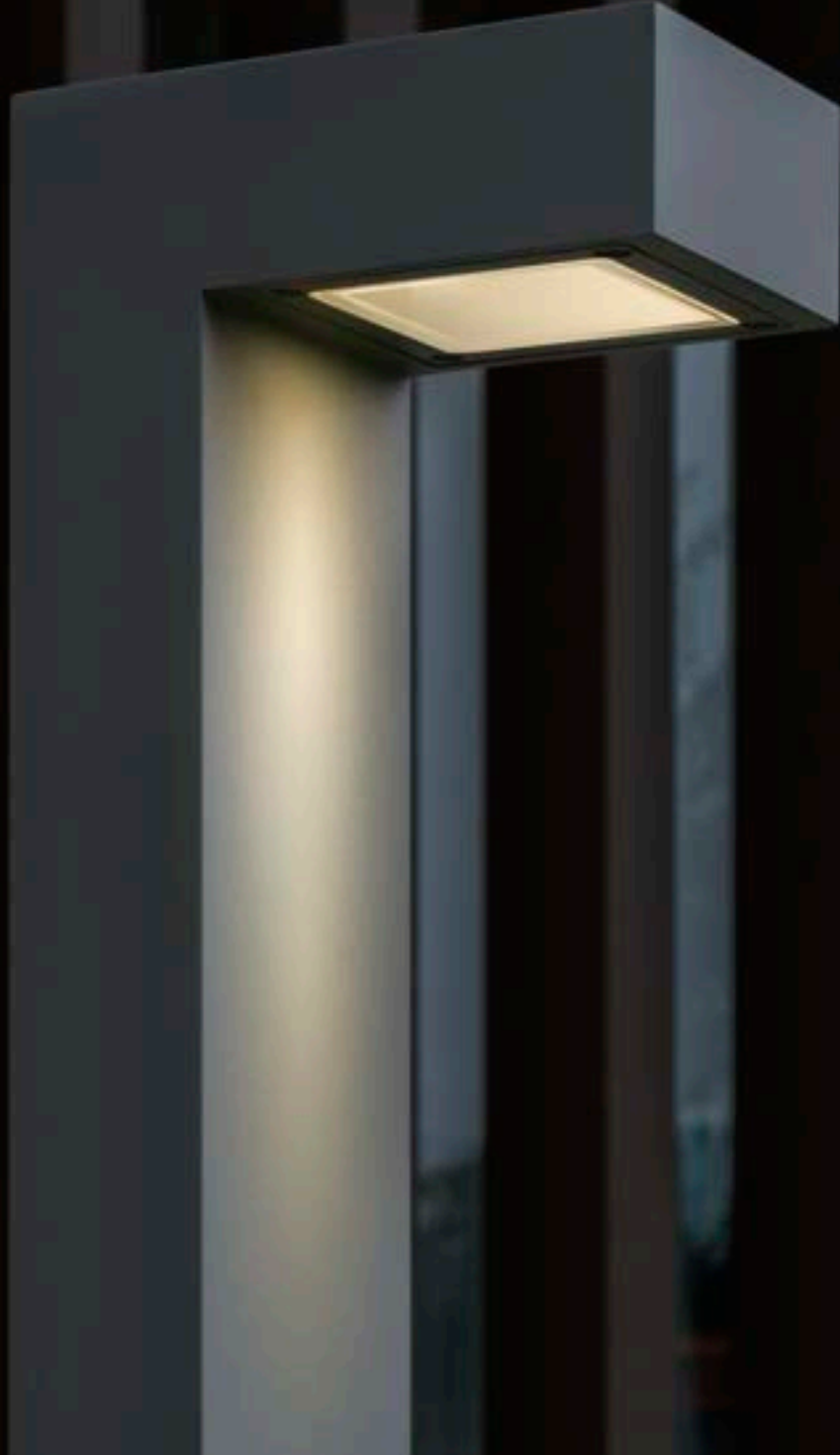
Powder coated aluminum body.
Clear Pyrex glass diffuser. Available
finishes: anthracite, white, coffee,
grey or black.



















SOLE

Opal color plastic diffuser.
Supplied with cable, plug and picket
for the installation on the ground.









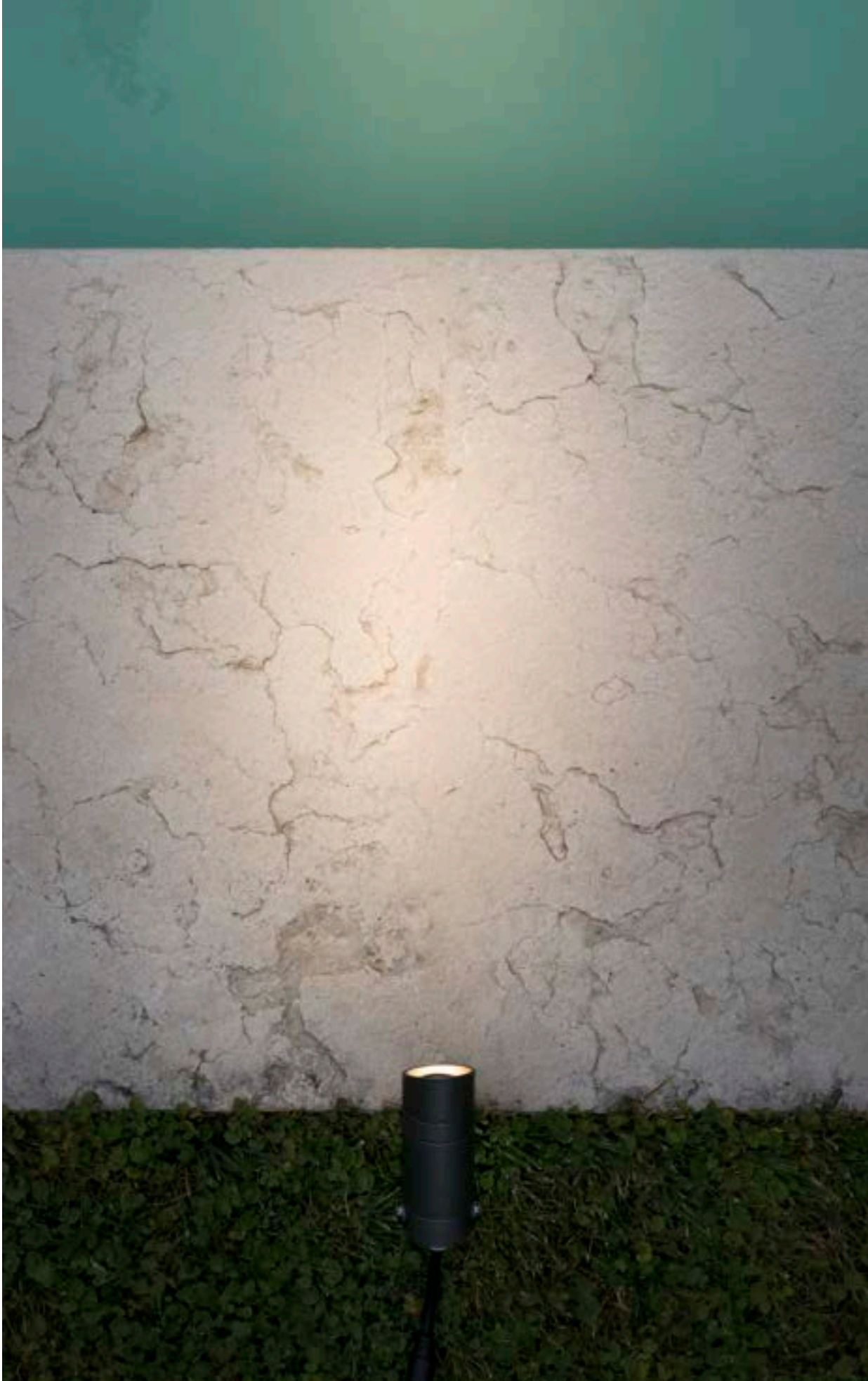




STARLIGHT

Aluminum adjustable tracklight with ceiling or peg installation; dark gray anodized and powder coated surface; integrated energy-efficient LED source with high color rendering; available with 3000k and 4000k color temperature; LED useful life 50.000 h. Optional anti-glare screen.













STYLE

Powder coated aluminum body.
Opal color plastic shade.
Integrated LED source. Available
finishes: anthracite, white, coffee,
grey or black.















SWIPE

Powder-coated aluminium body. Adjustable diffuser with shiny opal color polycarbonate screen. Available with twilight and motion sensor. Available finishes: anthracite, white, grey, coffee or black.



WALL LAMPS OUTDOORS IDEAL LUX











TAURUS

Recessed projector for floor, wall or ceiling installation. Die-cast aluminum body, 316L stainless steel ring, glass diffuser, walkable (IP67, IK10), formwork included. Light modules individually adjustable +/- 30° using an external pin to narrow or direct the light beam.



RECESSED LIGHTS | OUTDOORS | IDEAL LUX

TAURUS











TECHO

Powder-coated die-cast aluminum body. Frosted clear tempered glass diffuser. Colors: anthracite, white, coffee or black.















TESLA

Powder painted aluminum body.
White plastic screen diffuser.
Downward light emission. Available
finishes: anthracite, white, coffee or
black.















VEGA

Aluminum body with matt powder coating. Clear tempered glass diffuser. Available finishes: anthracite, white, coffee, grey or black.













LIST OF FINISHES



CLEAR



WHITE



FADE CHROME



STEEL



SILVER



CHROME



ALUMINUM



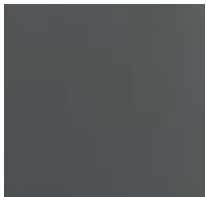
GREY



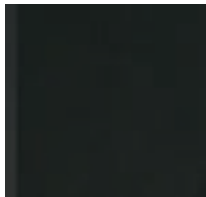
NICKEL



SMOKY GREY



ANTHRACITE



BLACK



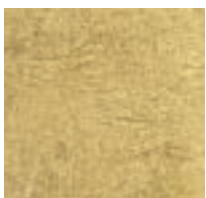
AMBER



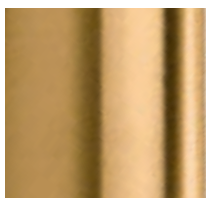
BEIGE



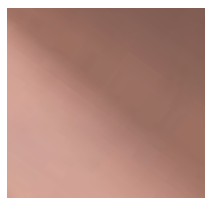
DOVE GREY



GOLD



BRASS



COPPER



COFFEE

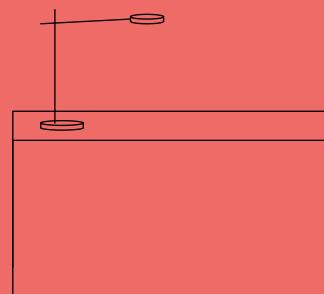
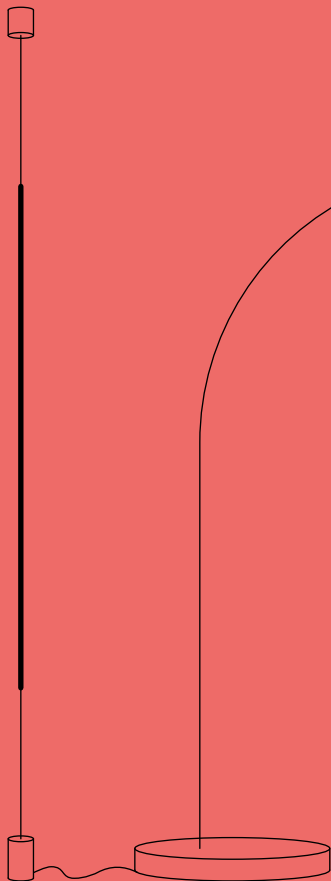
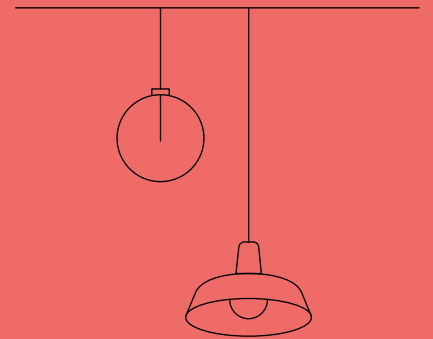
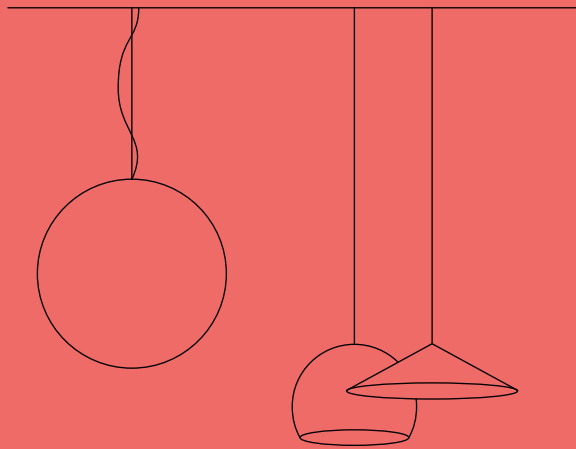


ANTIQUE BRASS

The finishes represented are for illustrative purpose only. The tones are subjected to variations due to the material type used and to its manufacturing which can modify the output,

as a consequence the items classified under the same finish can present some differences concerning color perception.

DATASHEETS



INDOORS DATASHEETS

Decorative lamps:
alphabetical and typology index

↳

BEAN



488

EGO



495

BINOMIO



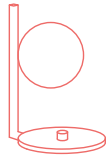
488

EQUINOXE



496

BIRDS



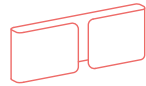
489

ESSENCE



498

CLIP



491

FILO



499

COVER



492

FLY



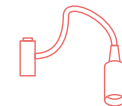
502

DELTA



493

FOCUS



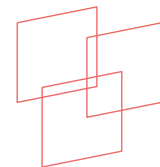
506

DIESIS



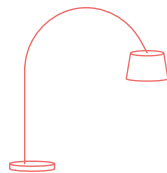
493

FRAME



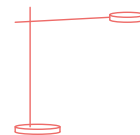
506

DORSALE



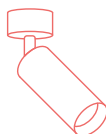
494

FUTURA



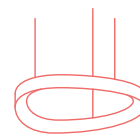
508

DYNAMITE



495

GEMINI



508

LOOK



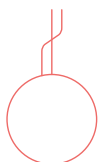
510

OZ



524

MAPA



512

PERLAGE



525

MINT



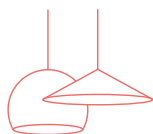
515

PIANO



528

MIX UP



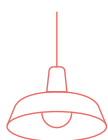
515

SET UP



528

MOBY



516

SMARTIES



532

NEMO



517

SPIKE



533

NINFEA



518

ULTRATHIN



534

NITRO



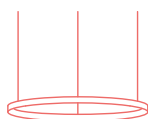
519

ZIG ZAG



535

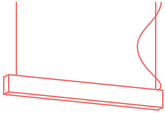
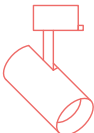
ORACLE SLIM



521

Technical lamps:
alphabetical and typology index



			LIKA		585
DEVA		536	LINK		588
DISPLAY		548	LINUS		600
EGO		551	NOVA		601
EOS		573	QUICK		602
FLUO		574	TESI		605
FOX		578	VIRUS		606
GAME		581	ZEUS		608

OUTDOORS DATASHEETS

Outdoor lamps:
alphabetical and typology index

↳

AGOS



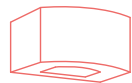
610

SIRIO



614

ANDROMEDA



610

SOLE



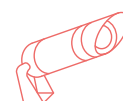
615

ATOM



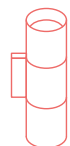
611

STARLIGHT



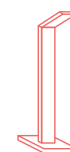
617

GUN



611

STYLE



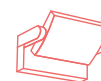
618

JEDI



612

SWIPE



619

LINEA



612

TAURUS



620

LOLITA



613

TECHO



621

PUNTO



613

TESLA



622

PURE



614

VEGA



622

BEAN

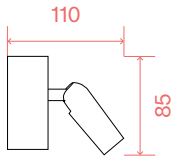
WALL



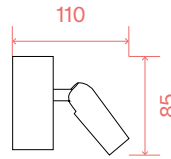
IP20



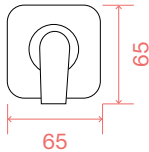
PHOTO p. 144



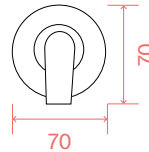
FINISH	CODE	€
White	260648	55
Nickel	260679	55
Black	260655	55
Brass	260662	55



FINISH	CODE	€
White	260600	55
Nickel	260631	55
Black	260617	55
Brass	260624	55



LED source 3000 K,
30.000 h life.



LED source 3000 K,
30.000 h life.



0,180 Kg
0,0008 m³
LED 3W / 260 lm

0,180 Kg
0,0005 m³
LED 3W / 260 lm

BINOMIO

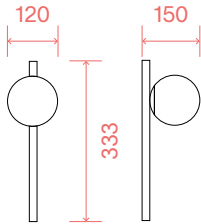
WALL



IP20



PHOTO p. 148



(RECOMMENDED)

LUMEN	CCT	CODE	€
510 lm	3000 K	305486	6

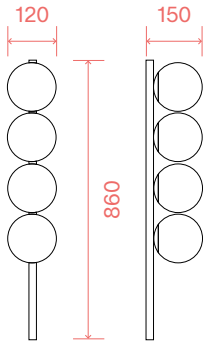
FINISH	CODE	€
White	328478	55
Black	310664	55
Brass	311319	55

0,5000 Kg
0,0081 m³
G9 max 1 x 4W

Bulbs LED G9 3W 3000 K
included. Cod. 209043

BINOMIO

WALL / CEILING

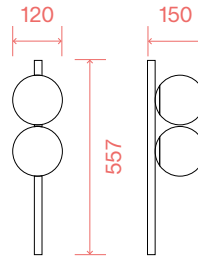


(RECOMMENDED)

LUMEN	CCT	CODE	€
510 lm	3000 K	305486	6
FINISH		CODE	€
White		328454	130
Black		310688	130
Brass		328461	130

Bulbs LED G9 3W 3000 K included. Cod. 209043

1,550 Kg
0,0240 m³
G9 max 4 x 4W



(RECOMMENDED)

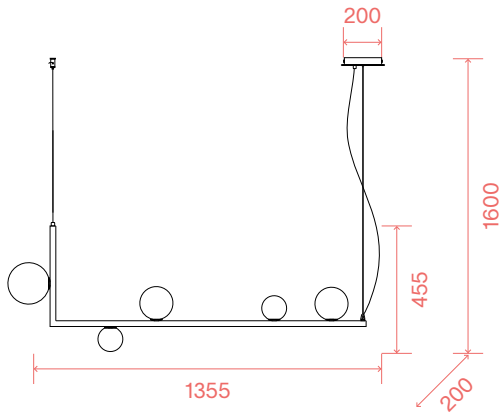
LUMEN	CCT	CODE	€
510 lm	3000 K	305486	6
FINISH		CODE	€
White		328430	90
Black		310671	90
Brass		328447	90

Bulbs LED G9 3W 3000 K included. Cod. 209043

1,200 Kg
0,0145 m³
G9 max 2 x 4W

BIRDS

SUSPENSION



(RECOMMENDED)

LUMEN	CCT	CODE	€
510 lm	3000 K	305486	6
FINISH		CODE	€
Black		273648	283

Bulbs LED G9 3W 3000 K included. Cod. 209043

2,750 Kg
0,1353 m³
G9 max 5 x 15W

BIRDS

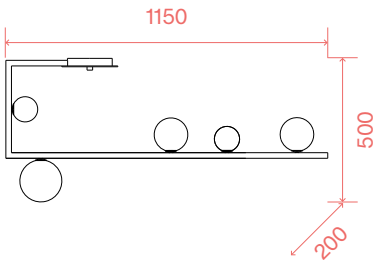
CEILING



IP20



PHOTO p. 114



2,800 Kg
0,1535 m³
G9 max 5 x 15W

(RECOMMENDED)

LUMEN	CCT	CODE	€
510 lm	3000 K	305486	6

FINISH	CODE	€
Black	273631	278

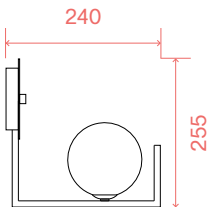


Bulbs LED G9 3W 3000 K
included. Cod. 209043

WALL



IP20



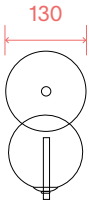
(RECOMMENDED)

LUMEN	CCT	CODE	€
510 lm	3000 K	305486	6

FINISH	CODE	€
Black	273655	73



Bulbs LED G9 3W 3000 K
included. Cod. 209043

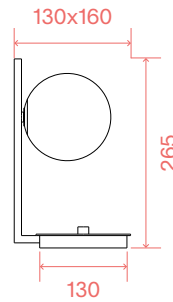


0,670 Kg
0,0192 m³
G9 max 1 x 15W

TABLE



IP20



(RECOMMENDED)

LUMEN	CCT	CODE	€
510 lm	3000 K	305486	6

FINISH	CODE	€
Black	273679	86



Bulbs LED G9 3W 3000 K
included. Cod. 209043

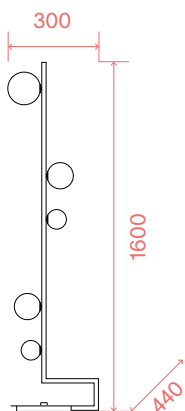


0,900 Kg
0,0163 m³
G9 max 1 x 15W

BIRDS

FLOOR


IP20   PHOTO p. 228



(RECOMMENDED)

LUMEN	CCT	CODE	€
510 lm	3000 K	305486	6

FINISH	CODE	€
Black	273662	340



 Bulbs LED G9 3W 3000 K included. Cod. 209043

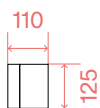
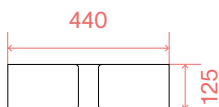


5,640 Kg
0,1536 m³
G9 max 5 x 15W

CLIP

WALL

IP20   PHOTO p. 152

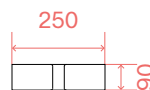


(RECOMMENDED)

LUMEN	CCT	CODE	€
430 lm	3000 K	101279	2

FINISH	CODE	€
White	014166	107
Silver	088273	107
Chrome	031361	107
Gold	088266	107
Coffee	187365	107

1,210 Kg
0,0161 m³
E27 max 2 x 60W



(RECOMMENDED)

LUMEN	CCT	CODE	€
510 lm	3000 K	305486	6

FINISH	CODE	€
White	049236	95
Silver	091136	95
Chrome	049229	95
Gold	091129	95
Coffee	170923	95

0,680 Kg
0,0035 m³
G9 max 2 x 40W

 Bulbs LED G9 3W 3000 K included. Cod. 209043

COVER

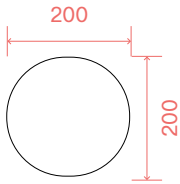
WALL / CEILING



IP20

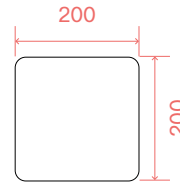


PHOTO p. 156



FINISH	CODE	€
White	195711	100
Black	195759	100

LED source 3000 K,
30.000 h life.

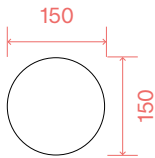


FINISH	CODE	€
White	195735	100
Black	195773	100

LED source 3000 K,
30.000 h life.

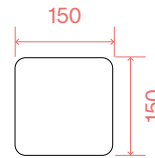
0,690 Kg
0,0028 m³
LED 11W / 1100 lm

0,860 Kg
0,0028 m³
LED 11W / 1100 lm



FINISH	CODE	€
White	195704	88
Black	195742	88

LED source 3000 K,
30.000 h life.



FINISH	CODE	€
White	195728	88
Black	195766	88

LED source 3000 K,
30.000 h life.

0,390 Kg
0,0018 m³
LED 9,5W / 730 lm

0,510 Kg
0,0018 m³
LED 9,5W / 730 lm

DELTA

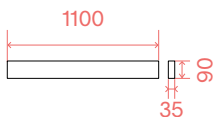
WALL



IP20



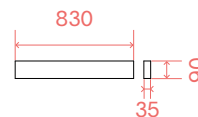
PHOTO p. 162



2,400 Kg
0,0102 m³
LED 37W
4300/4500 lm

FINISH	CCT	CODE	€
White	3000 K	287607	185
White	4000 K	307053	185
Black	3000 K	287591	185
Black	4000 K	307060	185

LED source 3000/4000 K,
35.000 h life.



0,900 Kg
0,0078 m³
LED 30W
3350/3500 lm

FINISH	CCT	CODE	€
White	3000 K	287621	160
White	4000 K	307039	160
Black	3000 K	287614	160
Black	4000 K	307046	160

LED source 3000/4000 K,
35.000 h life.

DELTA

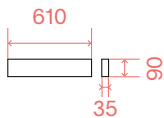
WALL



IP20



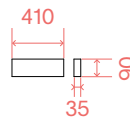
PHOTO p. 162



0,950 Kg
0,0058 m³
LED 19,5W
2200/2250 lm

FINISH	CCT	CODE	€
White	3000 K	287645	110
White	4000 K	307015	110
Black	3000 K	287638	110
Black	4000 K	307022	110

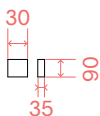
LED source 3000/4000 K,
35.000 h life.



0,580 Kg
0,0042 m³
LED 14W
1550/1650 lm

FINISH	CCT	CODE	€
White	3000 K	316789	81
White	4000 K	345192	81
Black	3000 K	345185	81
Black	4000 K	345208	81

LED source 3000/4000 K,
35.000 h life.



0,450 Kg
0,0030 m³
LED 10W
1700/1800 lm

FINISH	CCT	CODE	€
White	3000 K	345154	64
White	4000 K	345161	64
Black	3000 K	336510	64
Black	4000 K	345178	64

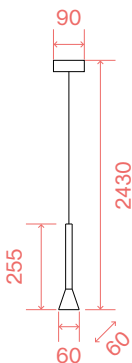
LED source 3000/4000 K,
35.000 h life.

DIESIS

SUSPENSION



IP20



0,450 Kg
0,0054 m³
LED 7W / 500 lm

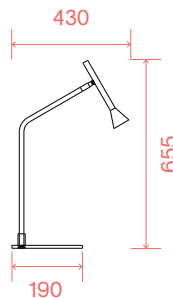
FINISH	CODE	€
Nickel	285122	110
Black	279770	110
Brass	279794	110

LED source 3000 K,
20.000 h life.

TABLE



IP20



1,700 Kg
0,0637 m³
LED 6,5W / 500 lm

FINISH	CODE	€
Nickel	291093	150
Black	283333	150
Brass	291109	150

LED source 3000 K,
30.000 h life.



DIESIS

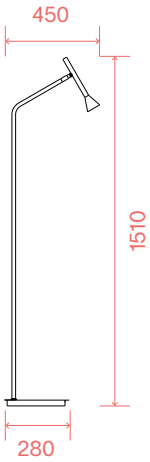
FLOOR



IP20



PHOTO p. 234



FINISH	CODE	€
Nickel	285337	180
Black	279800	180
Brass	285344	180

LED source 3000 K,
20.000 h life.

3,500 Kg
0,0222 m³
LED 4,5W / 280 lm

DORSALE

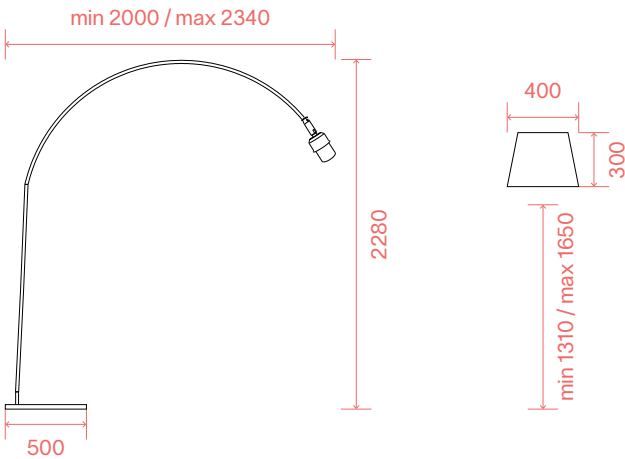
FLOOR



IP20



PHOTO p. 242



12,000 Kg
0,0856 m³
E27 max 1 x 60W

0,430 Kg
0,0709 m³

(RECOMMENDED)

LUMEN	CCT	CODE	€
1050 lm	3000 K	101347	6

FINISH	CODE	€
White	286686	600
Chrome	286662	600
Black	286679	600



SHADE

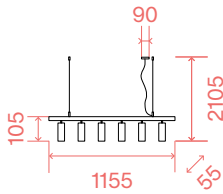
FINISH	CODE	€
White	046723	75
Chrome	041742	75
Black	046471	75

DYNAMITE

SUSPENSION



IP20



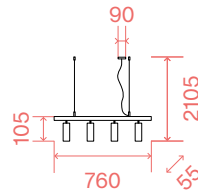
(RECOMMENDED)

LUMEN	CCT	CODE	€
540 lm	3000 K	123943	3,50

FINISH	CODE	€
White	231433	350
Black	231396	350
Brass	244648	350

2,700 Kg
0,0360 m³
GU10 max 6 x 28W

Bulbs LED GU10 7W
3000 K included. Cod. 123943



(RECOMMENDED)

LUMEN	CCT	CODE	€
540 lm	3000 K	123943	3,50

FINISH	CODE	€
White	231372	275
Black	231341	275
Brass	244624	275

2,310 Kg
0,0243 m³
GU10 max 4 x 28W

Bulbs LED GU10 7W
3000 K included. Cod. 123943

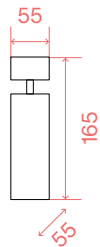
EGO

WALL / CEILING



IP20

PHOTO p. 118



(RECOMMENDED)

LUMEN	CCT	CODE	€
540 lm	3000 K	123943	3,50

FINISH	CODE	€
White	231495	98
Black	231471	98
Brass	244662	98

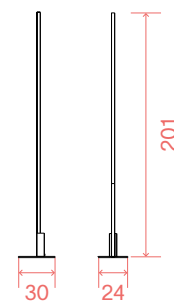
0,430 Kg
0,0037 m³
GU10 max 1 x 28W

Bulbs LED GU10 7W
3000 K included. Cod. 123943

FLOOR



IP20



FINISH	CODE	€
Black	344775	300

Composable light sources with light modules 1-10V from the Ego series (max 95 W, total length 1250 mm)



10,600 Kg
0,0259 m³

EQUINOXE

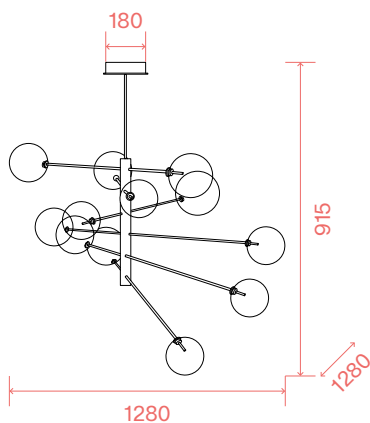
SUSPENSION



IP20



PHOTO p. 16



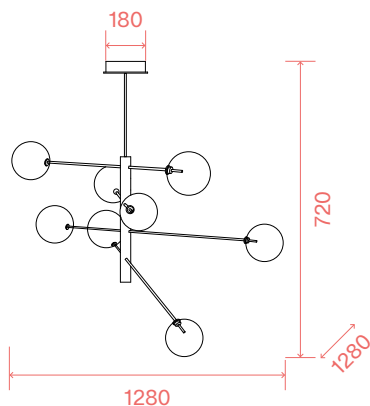
8,000 Kg
0,1487 m³
G4 max 12 x 2W

(RECOMMENDED)

LUMEN	CCT	CODE	€
200 lm	3000 K	222257	4

FINISH	CODE	€
Chrome	200118	1045
Brass	200125	1045
Fade Smoky Grey	345390	1045
Fade Amber	345383	1045

Bulbs LED G4 2W 3000 K included. Cod. 222257



5,200Kg
0,0938 m³
G4 max 8 x 2W

(RECOMMENDED)

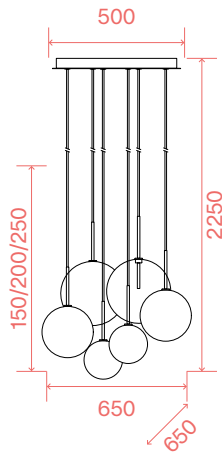
LUMEN	CCT	CODE	€
200 lm	3000 K	222257	4

FINISH	CODE	€
Chrome	275178	825
Brass	275215	825
Fade Smoky Grey	345437	825
Fade Amber	345420	825

Bulbs LED G4 2W 3000 K included. Cod. 222257

EQUINOXE

SUSPENSION



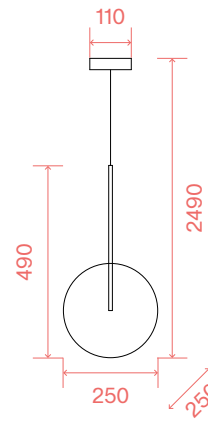
(RECOMMENDED)

LUMEN	CCT	CODE	€
200 lm	3000 K	222257	4

FINISH	CODE	€
Chrome	317250	715
Brass	317243	715
Fade Smoke	345413	715
Fade Amber	345406	715

LED Bulbs LED G4 2W 3000 K included. Cod. 222257

7,000 Kg
0,1274 m³
G4 max 6 x 2W



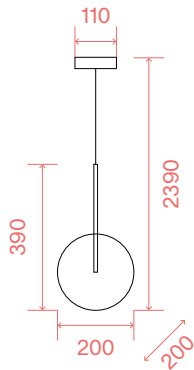
(RECOMMENDED)

LUMEN	CCT	CODE	€
200 lm	3000 K	222257	4

FINISH	CODE	€
Chrome	306551	198
Brass	277394	198
Fade Smoke	345376	198
Fade Amber	326368	198

LED Bulbs LED G4 2W 3000 K included. Cod. 222257

0,850 Kg
0,0326 m³
G4 max 1 x 2W



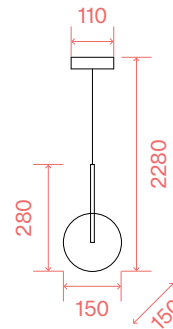
(RECOMMENDED)

LUMEN	CCT	CODE	€
200 lm	3000 K	222257	4

FINISH	CODE	€
Chrome	306544	154
Brass	277387	154
Fade Smoke	345369	154
Fade Amber	345352	154

LED Bulbs LED G4 2W 3000 K included. Cod. 222257

0,700 Kg
0,0211 m³
G4 max 1 x 2W



(RECOMMENDED)

LUMEN	CCT	CODE	€
200 lm	3000 K	222257	4

FINISH	CODE	€
Chrome	306537	132
Brass	277370	132
Fade Smoke	326351	132
Fade Amber	345345	132

LED Bulbs LED G4 2W 3000 K included. Cod. 222257

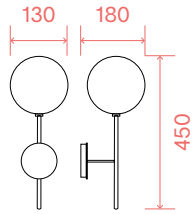
0,640 Kg
0,0170 m³
G4 max 1 x 2W

EQUINOXE

WALL



IP20



(RECOMMENDED)

LUMEN	CCT	CODE	€
200 lm	3000 K	222257	4

FINISH CODE €

Chrome 200132 145

Brass 200149 145

Fade Smoky Grey 345338 145

Fade Amber 345321 145

0,990 Kg
0,0243 m³
G4 max 1 x 2W

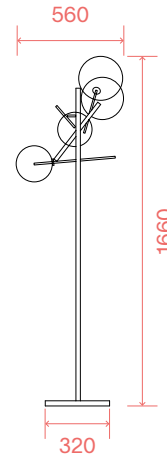
Bulbs LED G4 2W 3000 K included. Cod. 222257

FLOOR



IP20

↑ PHOTO p. 248



(RECOMMENDED)

LUMEN	CCT	CODE	€
200 lm	3000 K	222257	4

FINISH CODE €

Chrome 290959 550

Brass 290966 550

Fade Smoky Grey 348292 550

Fade Amber 348285 550

6,500 Kg
0,0882 m³
G4 max 4 x 2W

Bulbs LED G4 2W 3000 K included. Cod. 222257

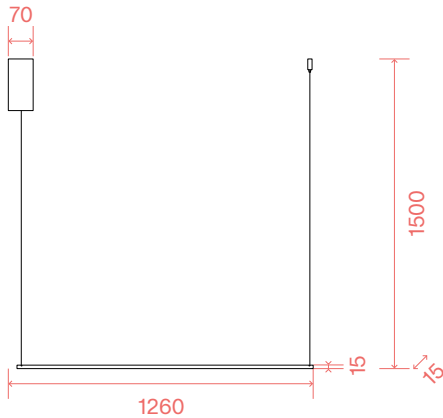


ESSENCE

SUSPENSION



IP20



FINISH	CCT	CODE	€
White	3000 K	285085	275
Black	2700 K	341033	275
Black	3000 K	285092	275
Black	4000 K	341040	275

LED source 2700/3000/4000 K, 30.000 h life.

0,900 Kg
0,0165 m³
LED 19W
2500/2750 lm

ESSENCE

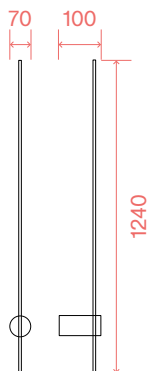
WALL / CEILING



IP20



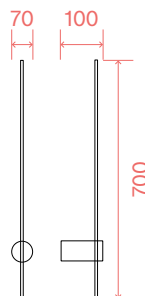
PHOTO p. 168



FINISH	CCT	CODE	€
White	3000 K	265575	240
Black	2700 K	341019	240
Black	3000 K	285108	240
Black	4000 K	341026	240

LED source 2700/3000/
4000 K, 30.000 h life.

1,040 Kg
0,0163 m³
LED 19W
2500/2700 lm



FINISH	CCT	CODE	€
White	3000 K	285115	182
Black	2700 K	340999	182
Black	3000 K	265643	182
Black	4000 K	341002	182

LED source 2700/3000/
4000 K, 30.000 h life.

0,800 Kg
0,0205 m³
LED 12W
1550/1700 lm

FILO

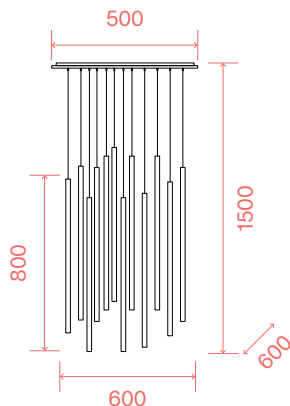
SUSPENSION



IP20



PHOTO p. 20



FINISH	CCT	CODE	€
White	2700 K	341088	450
White	3000 K	263441	450
Black	2700 K	341095	450
Black	3000 K	263434	450
Brass	2700 K	341101	450
Brass	3000 K	263663	450

LED source 2700/3000 K,
20.000 h life.

8,600 Kg
0,0635 m³
LED 19W
1550/1650 lm

FILO

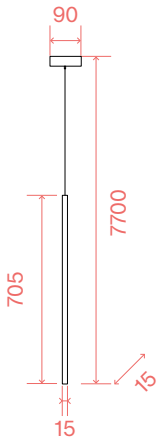
SUSPENSION



IP20



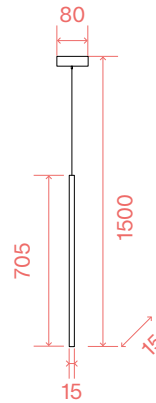
IP20



FINISH	CODE	€
White	300818	110
Black	300801	110
Brass	300825	110

LED source 3000 K,
20.000 h life.

0,830 Kg
0,0105 m³
LED 3,5W / 220 lm



FINISH	CCT	CODE	€
White	2700 K	341057	75
White	3000 K	263687	75
Black	2700 K	341064	75
Black	3000 K	263670	75
Brass	2700 K	341071	75
Brass	3000 K	263700	75

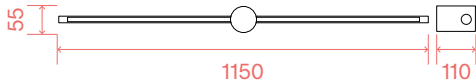
LED source 2700/3000 K,
20.000 h life.

0,530 Kg
0,0142 m³
LED 3,5W / 220 lm

WALL / CEILING



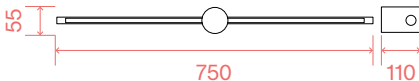
IP20



FINISH	CODE	€
White	327778	220
Black	310152	220
Brass	327785	220

LED source 3000 K,
20.000 h life.

0,610 Kg
0,0138 m³
LED 16W / 1950 lm



FINISH	CODE	€
White	310138	190
Black	310145	190
Brass	327792	190

LED source 3000 K,
20.000 h life.

0,500 Kg
0,0093 m³
LED 13W / 1400 lm

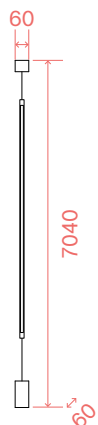
FILO

FLOOR



IP20

↑ PHOTO p. 254



FINISH	CCT	CODE	€
White	2700 K	341118	250
White	3000 K	301051	250
Black	2700 K	341125	250
Black	3000 K	301068	250
Brass	2700 K	341132	250
Brass	3000 K	301075	250

LED source 2700/3000 K, 20.000 h life.



1,200 Kg
0,0124 m³
LED 14W
1800/1850 lm

TABLE



IP20

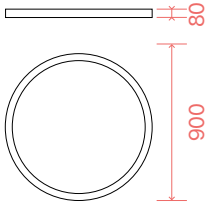


FINISH	CODE	€
White	310107	150
Black	310114	150
Brass	310121	150

LED source 3000 K, 20.000 h life.



0,500 Kg
0,0093 m³
LED 10W / 1100 lm



13,000 Kg
0,1441 m³

**KIT PENDANT
(OPTIONAL)**

White
cod. 254289, € 50
Black
cod. 307244, € 50

LED SMD SAMSUNG, DRIVER TRIDONIC ON/OFF (INCLUDED)

POWER	BEAM	LUMEN	CCT	FINISH	CODE	€
68 W	87°	7350 lm	2700 K	White	341200	1180
68 W	87°	7350 lm	2700 K	Black	341217	1180
68 W	87°	9000 lm	3000 K	White	270326	1180
68 W	87°	9000 lm	3000 K	Black	306629	1180
68 W	87°	9550 lm	4000 K	White	270241	1180
68 W	87°	9550 lm	4000 K	Black	306636	1180

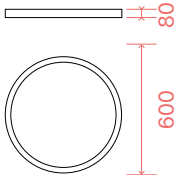
DIMMABLE DRIVER (NOT INCLUDED/OPTIONAL)

	POWER	OUTPUT	MEASURE	CODE	€
1-10V	68 W	1400 mA	130 x 25 x 75 mm	270357	125
DALI / Push	100 W	1400 mA	140 x 30 x 100 mm	270388	180

UPLIGHT (NOT INCLUDED/OPTIONAL)

POWER	BEAM	LUMEN	CCT	CODE	€
25 W	120°	3500 lm	3000 K	271002	225
25 W	120°	3650 lm	4000 K	270715	225

LED SMD SAMSUNG, DRIVER TRIDONIC ON/OFF (INCLUDED)



7,200 Kg
0,0694 m³

**KIT PENDANT
(OPTIONAL)**

White
cod. 254289, € 50
Black
cod. 307244, € 50

DIMMABLE DRIVER (NOT INCLUDED/OPTIONAL)

	POWER	OUTPUT	MEASURE	CODE	€
1-10V	60 W	1400 mA	124 x 23 x 82 mm	270340	112
DALI / Push	60 W	1400 mA	125 x 28 x 85 mm	270371	135

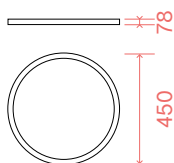
UPLIGHT (NOT INCLUDED/OPTIONAL)

POWER	BEAM	LUMEN	CCT	CODE	€
17,5 W	120°	2500 lm	3000 K	270401	150
17,5 W	120°	2650 lm	4000 K	270265	150

FLY

WALL / CEILING

IP40 MacAdam: SDCM 3 UGR: <19 CRI >90 LED LIFE: 50.000 h



3,800 Kg
0,0251 m³

KIT PENDANT
(OPTIONAL)

White
cod. 254289, € 50
Black
cod. 307244, € 50

LED SMD SAMSUNG, DRIVER TRIDONIC ON/OFF (INCLUDED)

POWER	BEAM	LUMEN	CCT	FINISH	CODE	€
26 W	87°	3000 lm	2700 K	White	341163	420
26 W	87°	3000 lm	2700 K	Black	341170	420
26 W	87°	3900 lm	3000 K	White	254272	420
26 W	87°	3900 lm	3000 K	Black	306599	420
26 W	87°	4300 lm	4000 K	White	270296	420
26 W	87°	4300 lm	4000 K	Black	306605	420

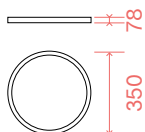
DIMMABLE DRIVER (NOT INCLUDED/OPTIONAL)

	POWER	OUTPUT	MEASURE	CODE	€
1-10V / Push	32 W	700 mA	94 x 21 x 67 mm	270586	75
DALI / Push	38 W	700 mA	94 x 21 x 67 mm	270593	95

UPLIGHT (NOT INCLUDED/OPTIONAL)

POWER	BEAM	LUMEN	CCT	CODE	€
11 W	120°	1350 lm	3000 K	270258	85
11 W	120°	1700 lm	4000 K	270395	85

LED SMD SAMSUNG, DRIVER TRIDONIC ON/OFF (INCLUDED)



3,000 Kg
0,0160 m³

KIT PENDANT
(OPTIONAL)

White
cod. 254289, € 50
Black
cod. 307244, € 50

POWER	BEAM	LUMEN	CCT	FINISH	CODE	€
18 W	87°	2150 lm	2700 K	White	341149	315
18 W	87°	2150 lm	2700 K	Black	341156	315
18 W	87°	2800 lm	3000 K	White	270272	315
18 W	87°	2800 lm	3000 K	Black	306575	315
18 W	87°	3000 lm	4000 K	White	270289	315
18 W	87°	3000 lm	4000 K	Black	306582	315

DIMMABLE DRIVER (NOT INCLUDED/OPTIONAL)

	POWER	OUTPUT	MEASURE	CODE	€
1-10V / Push	20 W	500 mA	108 x 22 x 52 mm	270333	65
DALI	20 W	500 mA	108 x 22 x 52 mm	270364	85

UPLIGHT (NOT INCLUDED/OPTIONAL)

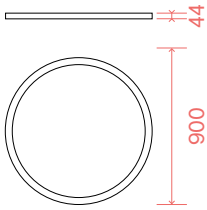
POWER	BEAM	LUMEN	CCT	CODE	€
11 W	120°	1000 lm	3000 K	270258	85
11 W	120°	1300 lm	4000 K	270395	85

FLY SLIM

WALL / CEILING



IP40 MacAdam: SDCM 3 UGR: <19 CRI >90 LED LIFE: 50.000 h



13,000 Kg
0,1448 m³

KIT PENDANT
(OPTIONAL)

White
cod. 254289, € 50

LED SMD SAMSUNG, DRIVER TRIDONIC ON/OFF (INCLUDED)

POWER	BEAM	LUMEN	CCT	FINISH	CODE	€
68 W	87°	7350 lm	2700 K	White	341255	1125
68 W	87°	9000 lm	3000 K	White	306681	1125
68 W	87°	9550 lm	4000 K	White	306698	1125

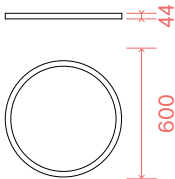
DIMMABLE DRIVER (NOT INCLUDED/OPTIONAL)

	POWER	OUTPUT	MEASURE	CODE	€
1-10V	68 W	1400 mA	130 x 25 x 75 mm	270357	125
DALI / Push	100 W	1400 mA	140 x 30 x 100 mm	270388	180

UPLIGHT (NOT INCLUDED/OPTIONAL)

POWER	BEAM	LUMEN	CCT	CODE	€
25 W	120°	3500 lm	3000 K	271002	225
25 W	120°	3650 lm	4000 K	270715	225

LED SMD SAMSUNG, DRIVER TRIDONIC ON/OFF (INCLUDED)



6,150 Kg
0,0694 m³

KIT PENDANT
(OPTIONAL)

White
cod. 254289, € 50

POWER	BEAM	LUMEN	CCT	FINISH	CODE	€
53 W	87°	5600 lm	2700 K	White	341248	575
53 W	87°	7200 lm	3000 K	White	292250	575
53 W	87°	7700 lm	4000 K	White	306674	575

DIMMABLE DRIVER (NOT INCLUDED/OPTIONAL)

	POWER	OUTPUT	MEASURE	CODE	€
1-10V	60 W	1400 mA	124 x 23 x 82 mm	270340	112
DALI / Push	60 W	1400 mA	125 x 28 x 85 mm	270371	135

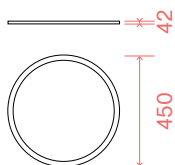
UPLIGHT (NOT INCLUDED/OPTIONAL)

POWER	BEAM	LUMEN	CCT	CODE	€
17,5 W	120°	2500 lm	3000 K	270401	150
17,5 W	120°	2650 lm	4000 K	270265	150

FLY SLIM

WALL / CEILING

⊕ IP40 MacAdam: SDCM 3 UGR: <19 CRI >90 LED LIFE: 50.000 h



3,750 Kg
0,0170 m³

KIT PENDANT
(OPTIONAL)
White
cod. 254289, € 50

LED SMD SAMSUNG, DRIVER TRIDONIC ON/OFF (INCLUDED)

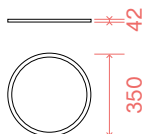
POWER	BEAM	LUMEN	CCT	FINISH	CODE	€
26 W	87°	3000 lm	2700 K	White	341231	390
26 W	87°	3900 lm	3000 K	White	292236	390
26 W	87°	4300 lm	4000 K	White	306667	390

DIMMABLE DRIVER (NOT INCLUDED/OPTIONAL)

	POWER	OUTPUT	MEASURE	CODE	€
1-10V / Push	32 W	700 mA	94 x 21 x 67 mm	270586	75
DALI / Push	38 W	700 mA	94 x 21 x 67 mm	270593	95

UPLIGHT (NOT INCLUDED/OPTIONAL)

POWER	BEAM	LUMEN	CCT	CODE	€
11 W	120°	1350 lm	3000 K	270258	85
11 W	120°	1700 lm	4000 K	270395	85



2,700 Kg
0,0105 m³

KIT PENDANT
(OPTIONAL)
White
cod. 254289, € 50

LED SMD SAMSUNG, DRIVER TRIDONIC ON/OFF (INCLUDED)

POWER	BEAM	LUMEN	CCT	FINISH	CODE	€
18 W	87°	2150 lm	2700 K	White	341224	295
18 W	87°	2800 lm	3000 K	White	306643	295
18 W	87°	3000 lm	4000 K	White	306650	295

DIMMABLE DRIVER (NOT INCLUDED/OPTIONAL)

	POWER	OUTPUT	MEASURE	CODE	€
1-10V / Push	20 W	500 mA	108 x 22 x 52 mm	270333	65
DALI	20 W	500 mA	108 x 22 x 52 mm	270364	85

UPLIGHT (NOT INCLUDED/OPTIONAL)

POWER	BEAM	LUMEN	CCT	CODE	€
11 W	120°	1000 lm	3000 K	270258	85
11 W	120°	1300 lm	4000 K	270395	85

FOCUS

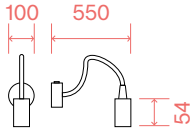
WALL



IP20



PHOTO p. 174

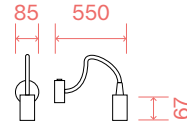


FINISH	CODE	€
White	097183	65
Chrome	097206	65
Black	097190	65

0,400 Kg
0,0025 m³
LED 4W / 310 lm



LED source 3000 K,
30.000 h life.



FINISH	CODE	€
White	203171	70
Chrome	203188	70
Black	203195	70

0,410 Kg
0,0020 m³
LED 3,5W / 280 lm



LED source 3000 K,
20.000 h life.



FRAME

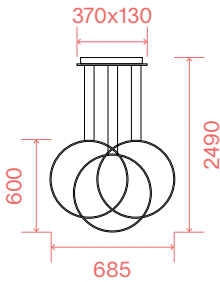
SUSPENSION



IP20



PHOTO p. 24

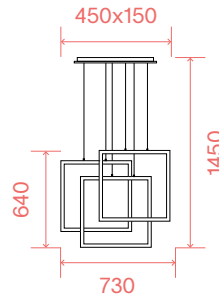


FINISH	CODE	€
White	269351	400
Black	269337	400



LED source 3000 K,
30.000 h life.

3,500 Kg
0,1050 m³
LED 82W / 6850 lm

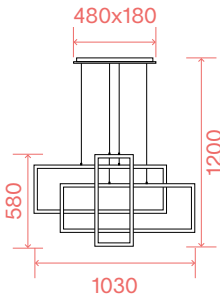


FINISH	CODE	€
White	253596	580
Black	269375	580



LED source 3000 K,
30.000 h life.

4,270 Kg
0,0689 m³
LED 80W / 8550 lm



FINISH	CODE	€
White	253589	600
Black	269382	600



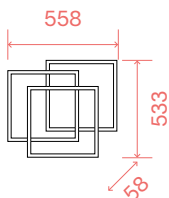
LED source 3000 K,
30.000 h life.

4,300 Kg
0,2100 m³
LED 93W / 1005 lm

FRAME


WALL / CEILING

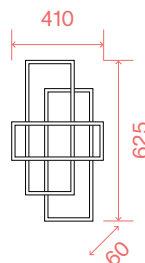
 IP20  PHOTO p. 130



1,430 Kg
0,0530 m³
LED 33W
3800/4200 lm


FINISH	CCT	CODE	€
White	2700 K	341316	320
White	3000 K	230702	320
Black	3000 K	270678	320

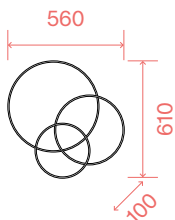
 LED source 2700/3000 K,
30.000 h life.



1,260 Kg
0,0241 m³
LED 33W
3400/3850 lm


FINISH	CCT	CODE	€
White	2700 K	341323	290
White	3000 K	230726	290
Black	3000 K	270661	290

 LED source 2700/3000 K,
30.000 h life.



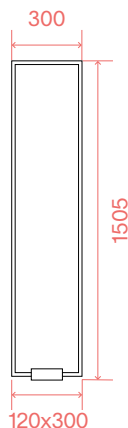
1,600 Kg
0,0458 m³
LED 41W
4550/5000 lm

FINISH	CCT	CODE	€
White	2700 K	341309	320
White	3000 K	255019	320
Black	3000 K	269825	320

 LED source 2700/3000 K,
30.000 h life.


FLOOR

 IP20



10,300 Kg
0,0525 m³
LED 30W / 3100 lm

FINISH	CODE	€
White	299624	450
Black	299617	450

 LED source 3000 K,
30.000 h life.



FUTURA

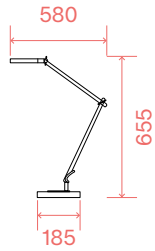
TABLE



IP20



PHOTO p. 200



1,830 Kg
0,0069 m³
LED 12,5W / 1050 lm

FINISH	CODE	€
White	272078	150
Aluminum	204895	150
Black	204888	150

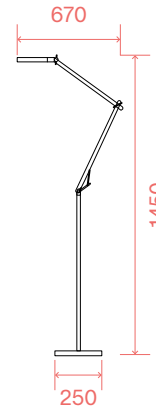
LED source 4000 K,
25.000 h life.



FLOOR



IP20



4,440 Kg
0,0095 m³
LED 12,5W / 1050 lm

FINISH	CODE	€
White	272085	215
Aluminum	204956	215
Black	204949	215

LED source 4000 K,
25.000 h life.



GEMINI

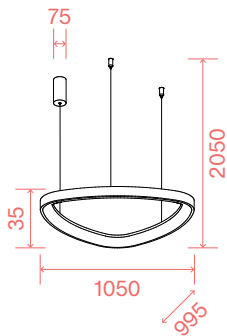
SUSPENSION



IP20



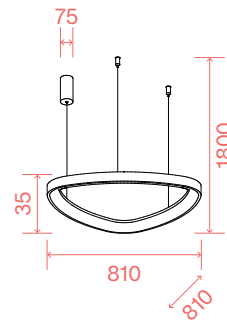
PHOTO p. 32



4,000 Kg
0,1145 m³
LED 78W
8500/8700 lm

ON-OFF			
FINISH	CCT	CODE	€
White	2700 K	341613	650
White	3000 K	303895	650
Black	2700 K	341620	650
Black	3000 K	307695	650
Brass	2700 K	341637	650
Brass	3000 K	307701	650

LED source 2700/3000 K,
50.000 h life.



2,300 Kg
0,0703 m³
LED 56W
6200/6300 lm

ON-OFF			
FINISH	CCT	CODE	€
White	2700 K	341583	430
White	3000 K	247274	430
Black	2700 K	341590	430
Black	3000 K	247281	430
Brass	2700 K	341606	430
Brass	3000 K	269849	430

DALI/PUSH

FINISH	CODE	€
White	304748	525
Black	304724	525
Brass	304731	525

LED source 2700/3000 K,
50.000 h life.

GEMINI

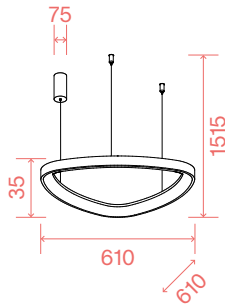
SUSPENSION



IP20



PHOTO p. 32



ON-OFF

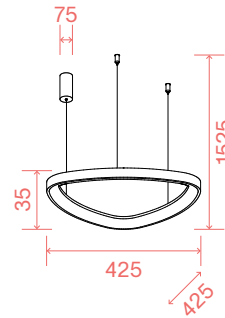
FINISH	CCT	CODE	€
White	2700 K	341552	330
White	3000 K	247250	330
Black	2700 K	341569	330
Black	3000 K	247267	330
Brass	2700 K	341576	330
Brass	3000 K	269832	330

1,710 Kg
0,0462 m³
LED 47W
4950/5100 lm

DALI/PUSH

FINISH	CODE	€
White	304717	425
Black	304694	425
Brass	304700	425

LED source 2700/3000 K,
50.000 h life.



ON-OFF

FINISH	CCT	CODE	€
White	2700 K	341521	240
White	3000 K	247229	240
Black	2700 K	341538	240
Black	3000 K	247236	240
Brass	2700 K	341545	240
Brass	3000 K	247243	240

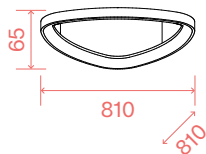
1,450 Kg
0,0201 m³
LED 36W
4000/4150 lm

LED source 2700/3000 K,
50.000 h life.

WALL / CEILING



IP20



ON-OFF

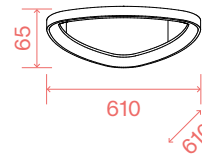
FINISH	CCT	CODE	€
White	2700 K	341491	390
White	3000 K	328072	390
Black	2700 K	341507	390
Black	3000 K	328089	390
Brass	2700 K	341514	390
Brass	3000 K	328096	390

4,800 Kg
0,0919 m³
LED 42W
4150/4450 lm

DALI/PUSH

FINISH	CODE	€
White	328973	480
Black	328980	480
Brass	329260	480

LED source 2700/3000 K,
50.000 h life.



ON-OFF

FINISH	CCT	CODE	€
White	2700 K	341460	300
White	3000 K	328041	300
Black	2700 K	341477	300
Black	3000 K	328058	300
Brass	2700 K	341484	300
Brass	3000 K	328065	300

3,200 Kg
0,0507 m³
LED 30W
3300/3600 lm

LED 28W
3100 lm

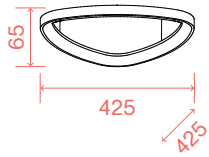
DALI/PUSH

FINISH	CODE	€
White	328942	380
Black	328959	380
Brass	328966	380

LED source 2700/3000 K,
50.000 h life.

GEMINI

WALL / CEILING



1,900 Kg
0,0271 m³
LED 24W
2300/2900 lm

ON-OFF

FINISH	CCT	CODE	€
White	2700 K	341439	220
White	3000 K	328010	220
Black	2700 K	341446	220
Black	3000 K	328027	220
Brass	2700 K	341453	220
Brass	3000 K	328034	220

LED source 2700/3000 K, 50.000 h life.

LOOK

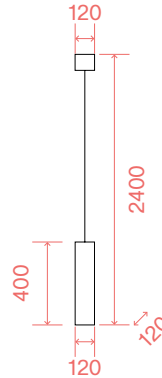
SUSPENSION



IP20



PHOTO p. 38



2,950 Kg
0,0092 m³
GU10 max 1 x 50W

(RECOMMENDED)

LUMEN	CCT	CODE	€
750 lm	3000 K	189031	15

FINISH	CODE	€
Black	158723	140

Bulbs LED GU10 10W 3000 K included. Cod. 189031

LOOK

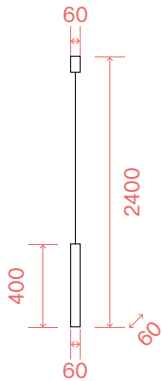
SUSPENSION



IP20



PHOTO p. 38



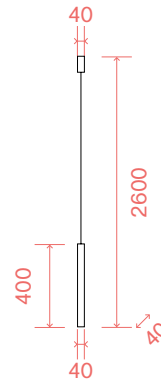
0,990 Kg
0,0029 m³
GU10 max 1 x 28W

(RECOMMENDED)

LUMEN	CCT	CODE	€
540 lm	3000 K	123943	3,50

FINISH	CODE	€
White	104935	60
Chrome	104942	80
Black	104928	60
Clear	194806	80
Silver	141800	80
Gold	141817	80
Brass	259239	60
Antique Brass	141794	80
Copper	141855	80
Coffee	170589	80

Bulbs LED GU10 7W 3000 K included. Cod. 123943



0,650 Kg
0,0019 m³
GU10 max 1 x 28W

(RECOMMENDED)

LUMEN	CCT	CODE	€
340 lm	3000 K	339771	3

FINISH	CODE	€
White	346854	65
Chrome	346861	65
Black	343310	65

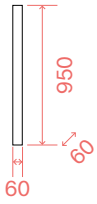
Bulbs LED GU10 4W 3000 K included. Cod. 339771

LOOK

CEILING



(RECOMMENDED)

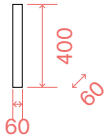


LUMEN	CCT	CODE	€
540 lm	3000 K	123943	3,50
FINISH		CODE	€
White		259260	86
Black		259277	86

3,070 Kg
0,0053 m³
GU10 max 1 x 28W

Bulbs LED GU10 7W 3000 K included. Cod. 123943

(RECOMMENDED)

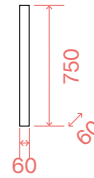


LUMEN	CCT	CODE	€
540 lm	3000 K	123943	3,50
FINISH		CODE	€
White		233215	42
Black		233192	42

0,740 Kg
0,0025 m³
GU10 max 1 x 28W

Bulbs LED GU10 7W 3000 K included. Cod. 123943

(RECOMMENDED)

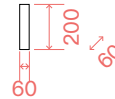


LUMEN	CCT	CODE	€
540 lm	3000 K	123943	3,50
FINISH		CODE	€
White		233352	60
Black		233321	60

1,380 Kg
0,0043 m³
GU10 max 1 x 28W

Bulbs LED GU10 7W 3000 K included. Cod. 123943

(RECOMMENDED)

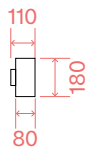


LUMEN	CCT	CODE	€
540 lm	3000 K	123943	3,50
FINISH		CODE	€
White		233079	32
Black		285214	32
Brass		233062	32

0,400 Kg
0,0013 m³
GU10 max 1 x 28W

Bulbs LED GU10 7W 3000 K included. Cod. 123943

WALL



(RECOMMENDED)

LUMEN	CCT	CODE	€
540 lm	3000 K	123943	3,50
FINISH		CODE	€
White		096018	80
Chrome		094182	80
Black		095998	80
Copper		164847	80
Antique Brass		164823	80

0,500 Kg
0,0028 m³
GU10 max 2 x 28W

Bulbs LED GU10 7W 3000 K included. Cod. 123943

FLOOR



FINISH	CODE	€
White	304922	250
Black	304915	250

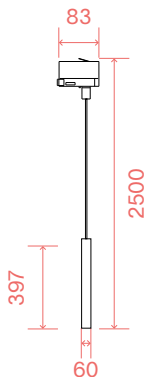
LED source 3000 K, 30.000 h life.



5,080 Kg
0,0809 m³
LED 24W / 2750 lm

LOOK

TRACK MOUNTED



(RECOMMENDED)

LUMEN	CCT	CODE	€
540 lm	3000 K	123943	3,50

FINISH	CODE	€
White	231662	80
Black	231631	80

Bulbs LED GU10 7W 3000 K included. Cod. 123943

LINK SINGLE CONNECTION

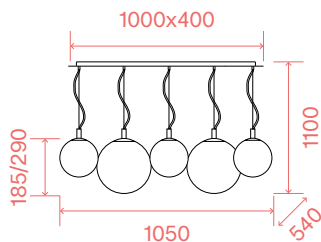
REQUIRED	DRIVER
NO	On/Off

FINISH	CODE	€
White	170145	23
Black	170152	23

0,930 Kg
0,0037 m³
GU10 max 1 x 28W

MAPA

SUSPENSION

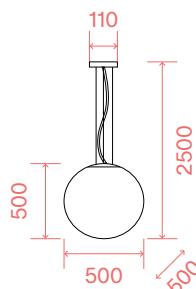


(RECOMMENDED)

LUMEN	CCT	CODE	€
910 lm	3000 K	119571	3,50

FINISH	CODE	€
White	043562	530

8,700 Kg
0,2470 m³
E27 max 5 x 42W

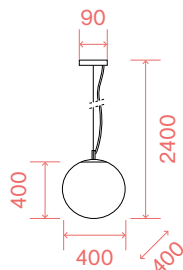


(RECOMMENDED)

LUMEN	CCT	CODE	€
910 lm	3000 K	119571	3,50

FINISH	CODE	€
White	032122	315

5,390 Kg
0,2254 m³
E27 max 1 x 42W

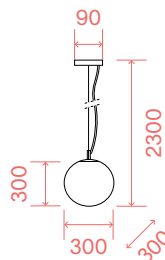


(RECOMMENDED)

LUMEN	CCT	CODE	€
910 lm	3000 K	119571	3,50

FINISH	CODE	€
White	032139	155

3,620 Kg
0,1215 m³
E27 max 1 x 42W



(RECOMMENDED)

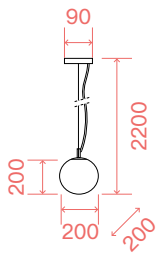
LUMEN	CCT	CODE	€
910 lm	3000 K	119571	3,50

FINISH	CODE	€
White	009087	90

1,920 Kg
0,0630 m³
E27 max 1 x 42W

MAPA

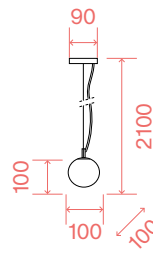
SUSPENSION



(RECOMMENDED)

LUMEN	CCT	CODE	€
910 lm	3000 K	119571	3,50
FINISH		CODE	€
White		009148	70

1,130 Kg
0,0272 m³
E27 max 1 x 42W



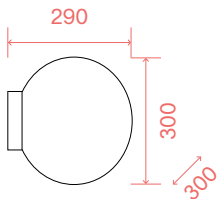
(RECOMMENDED)

LUMEN	CCT	CODE	€
510 lm	3000 K	305486	6
FINISH		CODE	€
White		310800	50

0,041 Kg
0,0027 m³
G9 max 1 x 4W

Bulbs LED G9 3W 3000 K
Cod. 209043

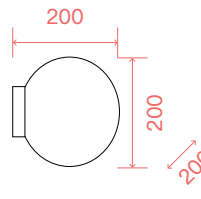
WALL/CEILING



(RECOMMENDED)

LUMEN	CCT	CODE	€
430 lm	3000 K	101279	2
FINISH		CODE	€
White		059822	88

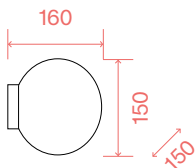
1,660 Kg
0,0647 m³
E27 max 1 x 42W



(RECOMMENDED)

LUMEN	CCT	CODE	€
430 lm	3000 K	101279	2
FINISH		CODE	€
White		059815	50

0,900 Kg
0,0259 m³
E27 max 1 x 42W

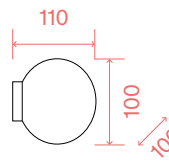


(RECOMMENDED)

LUMEN	CCT	CODE	€
510 lm	3000 K	305486	6
FINISH		CODE	€
White		059808	44

0,380 Kg
0,0115 m³
G9 max 1 x 15W

Bulbs LED G9 3W 3000 K
Cod. 209043



(RECOMMENDED)

LUMEN	CCT	CODE	€
510 lm	3000 K	305486	6
FINISH		CODE	€
White		310787	35

0,230 Kg
0,0025 m³
G9 max 1 x 4W

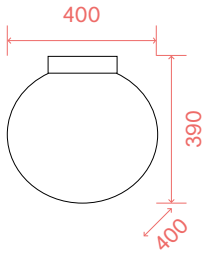
Bulbs LED G9 3W 3000 K
Cod. 209043

MAPA

CEILING



IP20



(RECOMMENDED)

LUMEN	CCT	CODE	€
910 lm	3000 K	119571	3,50

FINISH	CODE	€
White	059839	188

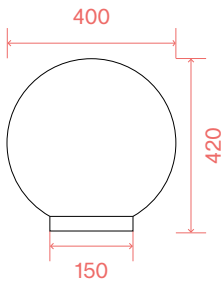
2,590 Kg
0,1290 m³
E27 max 1 x 42W

TABLE



IP20

↑ PHOTO p. 206



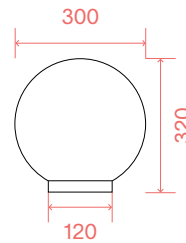
(RECOMMENDED)

LUMEN	CCT	CODE	€
910 lm	3000 K	119571	3,50

FINISH	CODE	€
White	000206	165



3,520 Kg
0,1354 m³
E27 max 1 x 42W



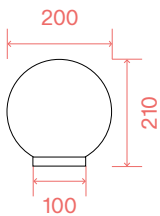
(RECOMMENDED)

LUMEN	CCT	CODE	€
910 lm	3000 K	119571	3,50

FINISH	CODE	€
White	009131	85



1,880 Kg
0,0515 m³
E27 max 1 x 42W



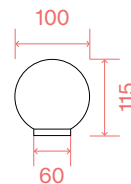
(RECOMMENDED)

LUMEN	CCT	CODE	€
910 lm	3000 K	119571	3,50

FINISH	CODE	€
White	009155	50



1,050 Kg
0,0214 m³
E27 max 1 x 42W



(RECOMMENDED)

LUMEN	CCT	CODE	€
510 lm	3000 K	305486	6

FINISH	CODE	€
White	310817	45



0,280 Kg
0,0026 m³
G9 max 1 x 4W

Bulbs LED G9 3W 3000 K
Cod. 209043



MINT

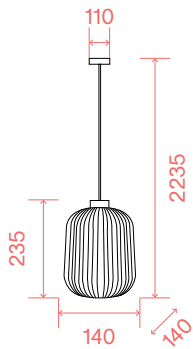
SUSPENSION



IP20



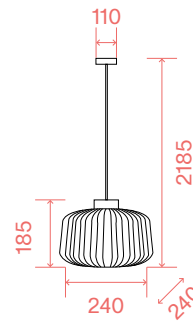
PHOTO p. 52



1,350 Kg
0,0147 m³
E27 max 1 x 60W

(RECOMMENDED)

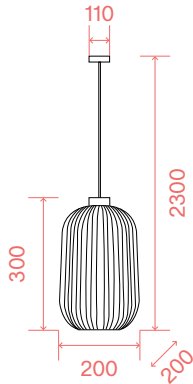
LUMEN	CCT	CODE	€
910 lm	3000 K	119571	3,50
FINISH		CODE	€
Smoky Grey		237442	105
Verde		248554	105



1,560 Kg
0,0532 m³
E27 max 1 x 60W

(RECOMMENDED)

LUMEN	CCT	CODE	€
910 lm	3000 K	119571	3,50
FINISH		CODE	€
Smoky Grey		237398	127
Verde		237428	127



1,80 Kg
0,0269 m³
E27 max 1 x 60W

(RECOMMENDED)

LUMEN	CCT	CODE	€
910 lm	3000 K	119571	3,50
FINISH		CODE	€
Smoky Grey		237510	138
Verde		237497	138

MIX UP

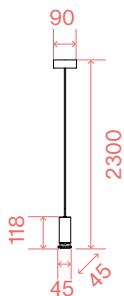
SUSPENSION



IP20



PHOTO p. 56



0,460 Kg
0,0018 m³
E27 max 1 x 60W

(RECOMMENDED)

LUMEN	CCT	CODE	€
900 lm	3000 K	123899	3,50
FINISH		CODE	€
White		288406	55
Black		288390	55

CEILING



IP20



0,270 Kg
0,0005 m³
E27 max 1 x 60W

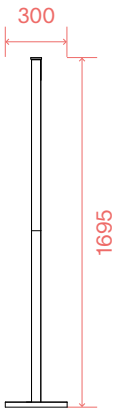
(RECOMMENDED)

LUMEN	CCT	CODE	€
900 lm	3000 K	123899	3,50
FINISH		CODE	€
White		292847	35
Black		292830	35

MIX UP

FLOOR

□ IP20

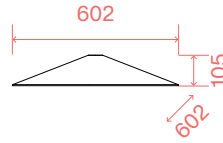


8,500 Kg
0,0326 m³
E27 max 1 x 42W

(RECOMMENDED)

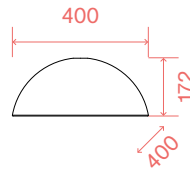
LUMEN	CCT	CODE	€
900 lm	3000 K	123899	3,50

FINISH	CODE	€
White	328164	200
Black	328171	200



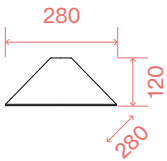
2,000 Kg
0,0676 m³

FINISH	CODE	€
White	288437	85
Black	288420	85



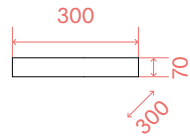
1,100 Kg
0,0446 m³

FINISH	CODE	€
White	307404	55
Black	288475	55



0,500 Kg
0,0174 m³

FINISH	CODE	€
White	307428	35
Black	288451	35



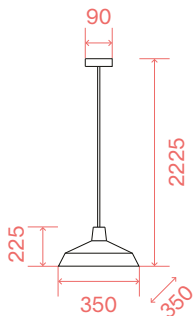
0,800 Kg
0,0147 m³

FINISH	CODE	€
White	307411	40
Black	288444	40

MOBY

SUSPENSION

□ IP20 ↑ PHOTO p. 68



1,200 Kg
0,0356 m³
E27 max 1 x 42W

(RECOMMENDED)

LUMEN	CCT	CODE	€
950 lm	3000 K	101330	4,50

FINISH	CODE	€
White	102047	127
Black	093659	127
Copper	093697	127

NEMO

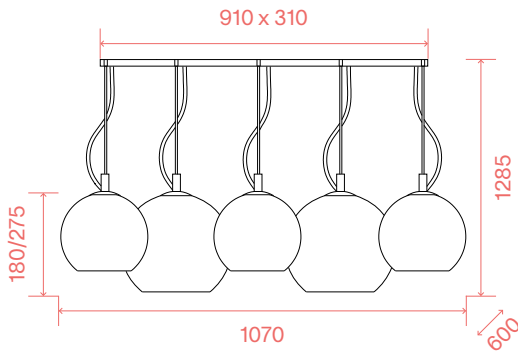
SUSPENSION



IP20



PHOTO p. 74

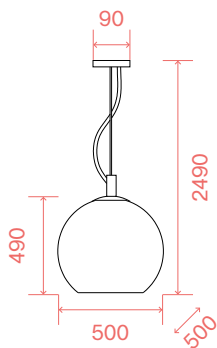


8,700 Kg
0,2424 m³
E27 max 5 x 42W

(RECOMMENDED)

LUMEN	CCT	CODE	€
910 lm	3000 K	119571	3,50

FINISH	CODE	€
Fade Chrome	138305	520

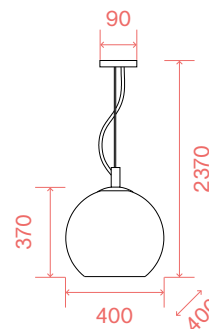


(RECOMMENDED)

LUMEN	CCT	CODE	€
1050 lm	3000 K	101347	6

FINISH	CODE	€
Smoky Grey	094137	450

4,000 Kg
0,2220 m³
E27 max 1 x 42W

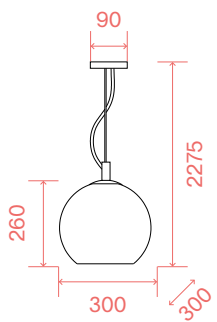


(RECOMMENDED)

LUMEN	CCT	CODE	€
1050 lm	3000 K	101347	6

FINISH	CODE	€
Clear	052816	200
Fade Chrome	250359	200
Smoky Grey	094229	200
Chrome	250342	200
Copper	111919	200
Amber	339061	200

2,700 Kg
0,1227 m³
E27 max 1 x 42W

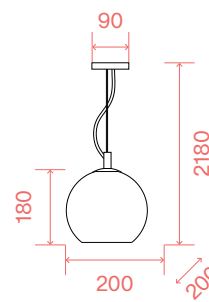


(RECOMMENDED)

LUMEN	CCT	CODE	€
1050 lm	3000 K	101323	4,50

FINISH	CODE	€
Clear	052809	115
Fade Chrome	149592	115
Smoky Grey	094236	115
Chrome	250335	115
Copper	111902	115
Amber	339054	115

2,050 Kg
0,0664 m³
E27 max 1 x 42W



(RECOMMENDED)

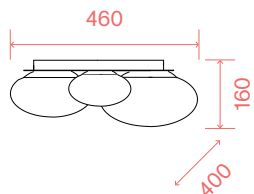
LUMEN	CCT	CODE	€
1050 lm	3000 K	101323	4,50

FINISH	CODE	€
Fade Chrome	149585	75
Smoky Grey	250311	75
Chrome	250304	75
Copper	250328	75
Amber	339047	75

1,300 Kg
0,0241 m³
E27 max 1 x 42W

NINFEA

CEILING



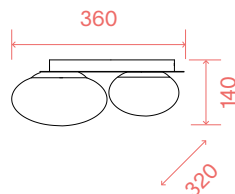
(RECOMMENDED)

LUMEN	CCT	CODE	€
910 lm	3000 K	123936	5

FINISH	CODE	€
White	306964	275
Brass	293660	275

Bulbs LED GX53 9W 3000 K included. Cod. 123936

2,550 Kg
0,0484 m³
GX53 max 3 x 15W



(RECOMMENDED)

LUMEN	CCT	CODE	€
910 lm	3000 K	123936	5

FINISH	CODE	€
White	306957	195
Brass	293653	195

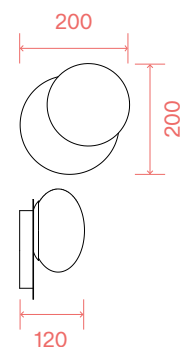
Bulbs LED GX53 9W 3000 K included. Cod. 123936

1,700 Kg
0,0302 m³
GX53 max 2 x 15W

WALL / CEILING



PHOTO p. 178



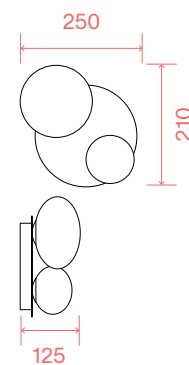
(RECOMMENDED)

LUMEN	CCT	CODE	€
910 lm	3000 K	123936	5

FINISH	CODE	€
White	306940	105
Brass	293646	105

Bulbs LED GX53 9W 3000 K included. Cod. 123936

0,800 Kg
0,0084 m³
GX53 max 1 x 15W



(RECOMMENDED)

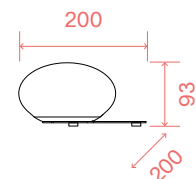
LUMEN	CCT	CODE	€
510 lm	3000 K	305486	6

FINISH	CODE	€
White	327716	132
Brass	346533	132

Bulbs LED G9 3W 3000 K included. Cod. 209043

0,800 Kg
0,0063 m³
G9 max 2 x 4W

TABLE



(RECOMMENDED)

LUMEN	CCT	CODE	€
910 lm	3000 K	123936	5

FINISH	CODE	€
White	318325	99
Brass	346526	99

Bulbs LED GX53 9W 3000 K included. Cod. 123936



1,100 Kg
0,0158 m³
GX53 max 1 x 15W

NITRO ROUND

CEILING



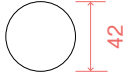
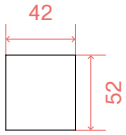
IP20



PHOTO p. 134



IP20

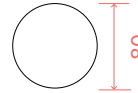
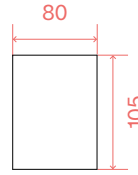


FINISH	CCT	CODE	€
White	2700 K	342788	45
White	3000 K	299419	45
Black	2700 K	342795	45
Black	3000 K	299402	45

LED source 2700/3000 K, 50.000 h life.



0,700 Kg
0,0004 m³
LED 4W
290/320 lm



FINISH	CCT	CODE	€
White	2700 K	341781	65
White	3000 K	205991	65
Black	2700 K	341798	65
Black	3000 K	206004	65

LED source 2700/3000 K, 50.000 h life.



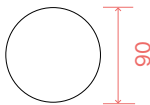
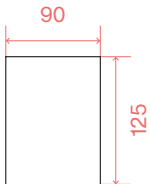
0,400 Kg
0,0011 m³
LED 10W
900/1000 lm



IP20



IP20

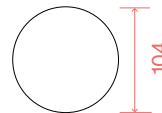
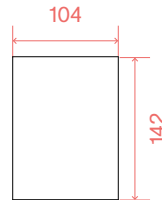


FINISH	CCT	CODE	€
White	3000 K	205977	90
Black	3000 K	205984	90

LED source 2700/3000 K, 50.000 h life.



0,910 Kg
0,0030 m³
LED 15W / 1400 lm



FINISH	CCT	CODE	€
White	3000 K	319568	115
Black	3000 K	322711	115

LED source 2700/3000 K, 50.000 h life.



0,860 Kg
0,0018 m³
LED 25W / 2350 lm

NITRO SQUARE

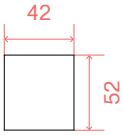
CEILING



IP20



IP20

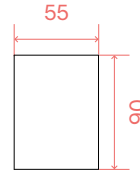


FINISH	CODE	€
White	319797	67
Black	319803	67

LED source 3000 K,
50.000 h life.



0,100 Kg
0,0004 m³
LED 5W
370/450 lm



FINISH	CODE	€
White	206035	65
Black	206042	65

LED source 3000 K,
50.000 h life.



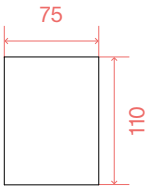
0,230 Kg
0,0005 m³
LED 10W / 1000 lm



IP20

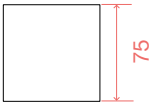


IP20

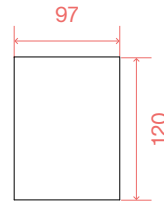


FINISH	CODE	€
White	206011	90
Black	206028	90

LED source 3000 K,
50.000 h life.



0,400 Kg
0,0013 m³
LED 15W / 1400 lm



FINISH	CODE	€
White	319575	115
Black	319582	115

LED source 3000 K,
50.000 h life.



0,700 Kg
0,0016 m³
LED 25W / 2350 lm

ORACLE SLIM

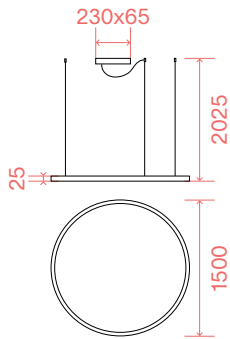
SUSPENSION



IP20 LED LIFE: 50.000 h



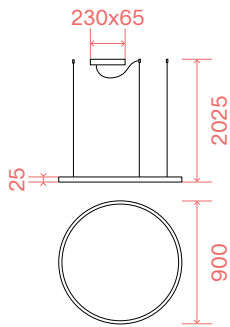
PHOTO p. 80



Cable length
2500 mm

LED SMD (DRIVER INCLUDED)

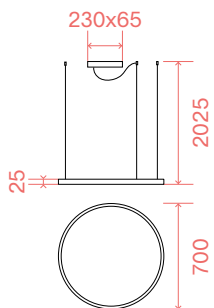
MEASURE	WEIGHT	VOLUME	POWER	DRIVER	LUMEN	CCT	FINISH	CODE	€
ø 1500	1,800 Kg	0,3072 m ³	83 W	On-Off	7850 lm	2700 K	White	342177	490
ø 1500	1,800 Kg	0,3072 m ³	87 W	On-Off	7850 lm	2700 K	Black	342160	490
ø 1500	2,480 Kg	0,3072 m ³	83 W	On-Off	8750 lm	3000 K	White	265957	490
ø 1500	2,480 Kg	0,3072 m ³	83 W	On-Off	8750 lm	3000 K	Black	285061	490
ø 1500	2,480 Kg	0,3072 m ³	83 W	On-Off	9350 lm	4000 K	White	285078	490
ø 1500	2,000 Kg	0,3072 m ³	83 W	On-Off	9350 lm	4000 K	Black	304472	490
ø 1500	2,000 Kg	0,3072 m ³	77 W	DALI/Push	7300 lm	3000 K	White	304465	625
ø 1500	2,000 Kg	0,3072 m ³	77 W	DALI/Push	7300 lm	3000 K	Black	304458	625
ø 1500	2,000 Kg	0,3072 m ³	77 W	DALI/Push	7450 lm	4000 K	White	342191	625
ø 1500	2,000 Kg	0,3072 m ³	77 W	DALI/Push	7450 lm	4000 K	Black	342184	625



Cable length
2500 mm

LED SMD (DRIVER INCLUDED)

MEASURE	WEIGHT	VOLUME	POWER	DRIVER	LUMEN	CCT	FINISH	CODE	€
ø 900	1,720 Kg	0,0839 m ³	53 W	On-Off	5150 lm	2700 K	White	342115	230
ø 900	1,720 Kg	0,0839 m ³	53 W	On-Off	5150 lm	2700 K	Black	342108	230
ø 900	1,800 Kg	0,2212 m ³	53 W	On-Off	5200 lm	3000 K	White	229478	230
ø 900	1,800 Kg	0,2212 m ³	53 W	On-Off	5200 lm	3000 K	Black	229508	230
ø 900	1,800 Kg	0,2212 m ³	53 W	On-Off	5350 lm	4000 K	White	269870	230
ø 900	1,800 Kg	0,2212 m ³	53 W	On-Off	5350 lm	4000 K	Black	304441	230
ø 900	1,500 Kg	0,0857 m ³	43 W	DALI/Push	4500 lm	3000 K	White	304434	375
ø 900	1,500 Kg	0,0857 m ³	43 W	DALI/Push	4500 lm	3000 K	Black	304427	375
ø 900	1,480 Kg	0,0839 m ³	42 W	DALI/Push	4600 lm	4000 K	White	342139	375
ø 900	1,480 Kg	0,0839 m ³	42 W	DALI/Push	4600 lm	4000 K	Black	342122	375



Cable length
2500 mm

LED SMD (DRIVER INCLUDED)

MEASURE	WEIGHT	VOLUME	POWER	DRIVER	LUMEN	CCT	FINISH	CODE	€
ø 700	1,260 Kg	0,0534 m ³	37 W	On-Off	3800 lm	2700 K	White	342054	245
ø 700	1,260 Kg	0,0534 m ³	37 W	On-Off	3800 lm	2700 K	Black	342047	245
ø 700	1,660 Kg	0,0809 m ³	37 W	On-Off	4250 lm	3000 K	White	229485	245
ø 700	1,660 Kg	0,0809 m ³	37 W	On-Off	4250 lm	3000 K	Black	229515	245
ø 700	1,660 Kg	0,0809 m ³	37 W	On-Off	4350 lm	4000 K	White	269863	245
ø 700	1,660 Kg	0,0809 m ³	37 W	On-Off	4350 lm	4000 K	Black	304410	245
ø 700	1,200 Kg	0,0534 m ³	37 W	DALI/Push	4200 lm	3000 K	White	304403	305
ø 700	1,200 Kg	0,0534 m ³	37 W	DALI/Push	4200 lm	3000 K	Black	304397	305
ø 700	1,200 Kg	0,0534 m ³	40 W	DALI/Push	4450 lm	4000 K	White	342078	305
ø 700	1,200 Kg	0,0534 m ³	40 W	DALI/Push	4450 lm	4000 K	Black	342061	305

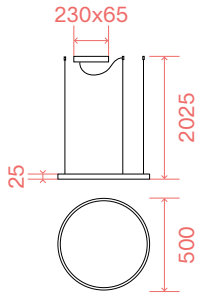
ORACLE SLIM

SUSPENSION



IP20 LED LIFE: 50.000 h

↑ PHOTO p. 80



Cable length
2500 mm

LED SMD (DRIVER INCLUDED)

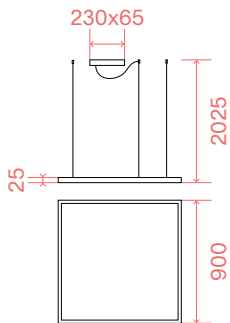
MEASURE	WEIGHT	VOLUME	POWER	DRIVER	LUMEN	CCT	FINISH	CODE	€
ø 500	1,200 Kg	0,0272 m ³	29 W	On-Off	2850 lm	2700 K	White	342016	180
ø 500	1,200 Kg	0,0272 m ³	29 W	On-Off	2850 lm	2700 K	Black	342009	180
ø 500	1,400 Kg	0,0376 m ³	29 W	On-Off	3000 lm	3000 K	White	229461	180
ø 500	1,400 Kg	0,0376 m ³	29 W	On-Off	3000 lm	3000 K	Black	229492	180
ø 500	1,400 Kg	0,0376 m ³	29 W	On-Off	3400 lm	4000 K	White	269856	180
ø 500	1,400 Kg	0,0376 m ³	29 W	On-Off	3400 lm	4000 K	Black	304380	180
ø 500	1,100 Kg	0,0272 m ³	29 W	DALI/Push	2850 lm	3000 K	White	304373	255
ø 500	1,100 Kg	0,0272 m ³	29 W	DALI/Push	2850 lm	3000 K	Black	304366	255
ø 500	1,170 Kg	0,0272 m ³	28 W	DALI/Push	3100 lm	4000 K	White	342030	255
ø 500	1,170 Kg	0,0272 m ³	28 W	DALI/Push	3100 lm	4000 K	Black	342023	255

ORACLE SLIM

SUSPENSION



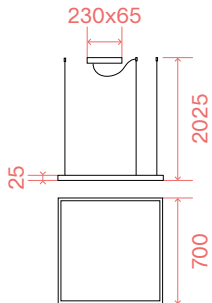
IP20 LED LIFE: 50.000 h



Cable length
2500 mm

LED SMD (DRIVER ON/OFF INCLUDED)

MEASURE	WEIGHT	VOLUME	POWER	DRIVER	LUMEN	CCT	FINISH	CODE	€
900 x 900	2,100 Kg	0,1317 m ³	53 W	On-Off	5200 lm	3000 K	White	259192	265
900 x 900	2,100 Kg	0,1317 m ³	53 W	On-Off	5200 lm	3000 K	Black	259208	265



Cable length
2500 mm

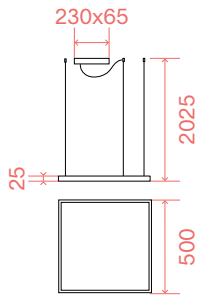
LED SMD (DRIVER ON/OFF INCLUDED)

MEASURE	WEIGHT	VOLUME	POWER	DRIVER	LUMEN	CCT	FINISH	CODE	€
700 x 700	2,000 Kg	0,0819 m ³	44 W	On-Off	4350 lm	3000 K	White	259178	275
700 x 700	2,000 Kg	0,0819 m ³	44 W	On-Off	4350 lm	3000 K	Black	259185	275

ORACLE SLIM

SUSPENSION

IP20 LED LIFE: 50.000 h



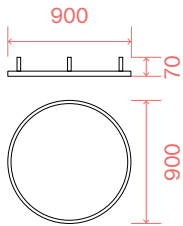
LED SMD (DRIVER ON/OFF INCLUDED)

MEASURE	WEIGHT	VOLUME	POWER	DRIVER	LUMEN	CCT	FINISH	CODE	€
500 x 500	1,730 Kg	0,0422 m ³	33 W	On-Off	3050 lm	3000 K	White	259154	205
500 x 500	1,730 Kg	0,0422 m ³	33 W	On-Off	3050 lm	3000 K	Black	259161	205

Cable length
2500 mm

CEILING

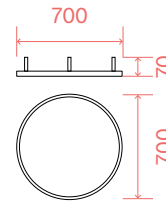
IP20 LED LIFE: 50.000 h



FINISH	CCT	CODE	€
White	2700 K	341972	295
White	3000 K	266015	295
White	4000 K	341996	295
Black	2700 K	341965	295
Black	3000 K	266022	295
Black	4000 K	341989	295

1,700 Kg
0,1345 m³
LED 53W
5150/5350 lm

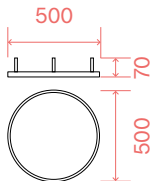
LED source 2700/3000/
4000 K, 50.000 h life.



FINISH	CCT	CODE	€
White	2700 K	341934	260
White	3000 K	265995	260
White	4000 K	341958	260
Black	2700 K	341927	260
Black	3000 K	266008	260
Black	4000 K	341941	260

1,430 Kg
0,0852 m³
LED 37W
3800/4350 lm

LED source 2700/3000/
4000 K, 50.000 h life.



FINISH	CCT	CODE	€
White	2700 K	341897	195
White	3000 K	265971	195
White	4000 K	341910	195
Black	2700 K	341880	195
Black	3000 K	265988	195
Black	4000 K	341903	195

1,240 Kg
0,0455 m³
LED 29W
2850/3400 lm

LED source 2700/3000/
4000 K, 50.000 h life.

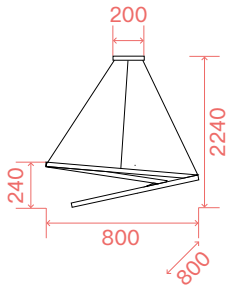
SUSPENSION



IP20



PHOTO p. 88



1,900 Kg
0,0607 m³
LED 52W
6000/6500 lm

LED 55W / 6100 lm

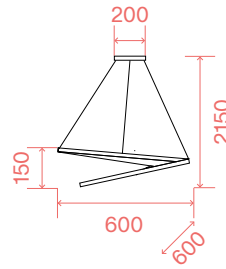
ON-OFF

FINISH	CCT	CODE	€
White	2700 K	342405	295
White	3000 K	253664	295
White	4000 K	342436	295
Black	2700 K	342412	295
Black	3000 K	269450	295
Black	4000 K	342443	295
Brass	2700 K	342429	295
Brass	3000 K	269467	295
Brass	4000 K	342450	295

DALI/PUSH

FINISH	CODE	€
White	304571	470
Black	304588	470
Brass	304595	470

LED source 3000 K,
30.000 h life.



1,500 Kg
0,0354 m³
LED 47W
4900/5500 lm

LED 48W / 5100 lm

ON-OFF

FINISH	CCT	CODE	€
White	2700 K	342344	250
White	3000 K	253671	250
White	4000 K	342375	250
Black	2700 K	342351	250
Black	3000 K	269436	250
Black	4000 K	342382	250
Brass	2700 K	342368	250
Brass	3000 K	269443	250
Brass	4000 K	342399	250

DALI/PUSH

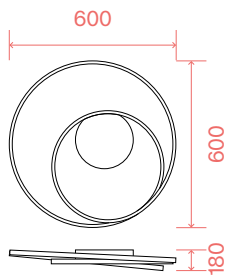
FINISH	CODE	€
White	304540	390
Black	304557	390
Brass	304564	390

LED source 3000 K,
30.000 h life.

CEILING



IP20



1,500 Kg
0,0354 m³
LED 47W
4900/5500 lm

DALI/PUSH
LED 48W / 5100 lm

ON-OFF

FINISH	CCT	CODE	€
White	2700 K	342283	215
White	3000 K	253688	215
White	4000 K	342213	215
Black	2700 K	342290	215
Black	3000 K	269412	215
Black	4000 K	342320	215
Brass	2700 K	342306	215
Brass	3000 K	269429	215
Brass	4000 K	342337	215

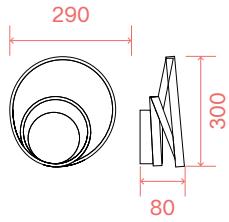
DALI/PUSH

FINISH	CODE	€
White	304519	370
Black	304526	370
Brass	304533	370

LED source 3000 K,
30.000 h life.

OZ

WALL



ON-OFF

FINISH	CCT	CODE	€
White	2700 K	342221	150
White	3000 K	253695	150
White	4000 K	342252	150
Black	2700 K	342238	150
Black	3000 K	269399	150
Black	4000 K	342269	150
Brass	2700 K	342245	150
Brass	3000 K	269405	150
Brass	4000 K	342276	150

0,800 Kg
0,0087 m³
LED 26W
2350/2650 lm

LED 28W / 2450 lm

DALI/PUSH

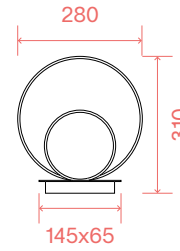
FINISH	CODE	€
White	304489	230
Black	304496	230
Brass	304502	230

LED source 3000 K, 30.000 h life.

TABLE



↑ PHOTO p. 212



ON-OFF

FINISH	CCT	CODE	€
White	2700 K	342467	140
White	3000 K	269474	140
White	4000 K	342498	140
Black	2700 K	342474	140
Black	3000 K	269481	140
Black	4000 K	342504	140
Brass	2700 K	342481	140
Brass	3000 K	269498	140
Brass	4000 K	342511	140

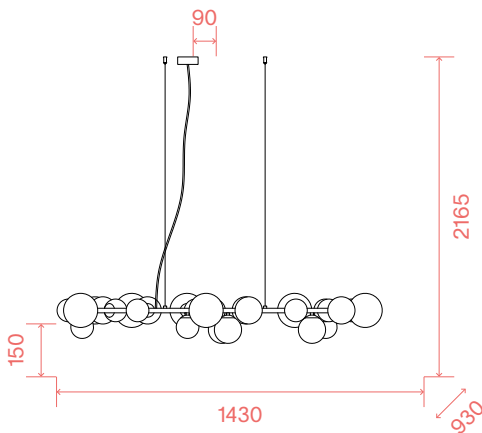
0,890 Kg
0,0096 m³
LED 22W
2400/2650 lm

LED source 2700/3000/4000 K, 30.000 h life.



PERLAGE

SUSPENSION



8,920 Kg
0,2722 m³
G9 max 30 x 15W

(RECOMMENDED)

LUMEN	CCT	CODE	€
510 lm	3000 K	305486	6

FINISH	CODE	€
White	296746	1610
Smoky Grey	296753	1610
Amber	322780	1610

Bulbs LED G9 3W 3000 K included. Cod. 209043

PERLAGE

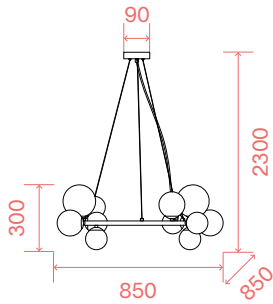
SUSPENSION



IP20



PHOTO p. 94

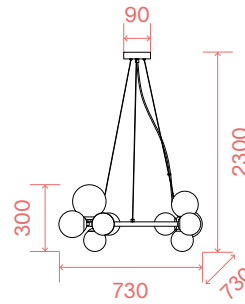


(RECOMMENDED)

LUMEN	CCT	CODE	€
510 lm	3000 K	305486	6
FINISH		CODE	€
White		283814	713
Smoky Grey		271385	713
Amber		322797	713

Bulbs LED G9 3W 3000 K included. Cod. 209043

3,910 Kg
0,0924 m³
G9 max 14 x 15W

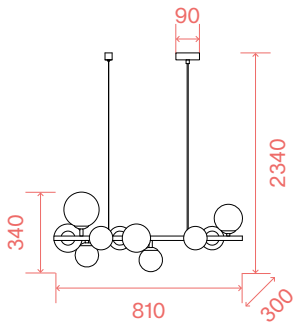


(RECOMMENDED)

LUMEN	CCT	CODE	€
510 lm	3000 K	305486	6
FINISH		CODE	€
White		283807	610
Smoky Grey		271392	610
Amber		322773	610

Bulbs LED G9 3W 3000 K included. Cod. 209043

3,100 Kg
0,0736 m³
G9 max 11 x 15W

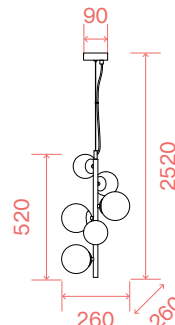


(RECOMMENDED)

LUMEN	CCT	CODE	€
510 lm	3000 K	305486	6
FINISH		CODICE	€
White		283791	448
Smoky Grey		271408	448
Amber		322766	448

Bulbs LED G9 3W 3000 K included. Cod. 209043

2,200 Kg
0,0617 m³
G9 max 10 x 15W



(RECOMMENDED)

LUMEN	CCT	CODE	€
510 lm	3000 K	305486	6
FINISH		CODE	€
White		283821	299
Smoky Grey		271422	299
Amber		317793	299

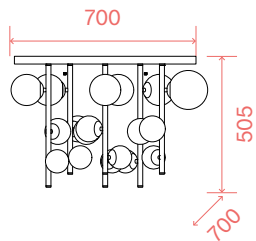
Bulbs LED G9 3W 3000 K included. Cod. 209043

1,300 Kg
0,0317 m³
G9 max 6 x 15W

CEILING



IP20

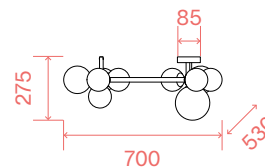


(RECOMMENDED)

LUMEN	CCT	CODE	€
510 lm	3000 K	305486	6
FINISH		CODE	€
White		328393	851
Smoky Grey		328386	851
Amber		328379	851

Bulbs LED G9 3W 3000 K included. Cod. 209043

7,520 Kg
0,1314 m³
G9 max 18 x 15W



(RECOMMENDED)

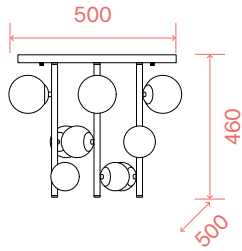
LUMEN	CCT	CODE	€
510 lm	3000 K	305486	6
FINISH		CODE	€
White		327815	518
Smoky Grey		309286	518
Amber		327808	518

Bulbs LED G9 3W 3000 K included. Cod. 209043

2,780 Kg
0,0605 m³
G9 max 10 x 15W

PERLAGE

CEILING

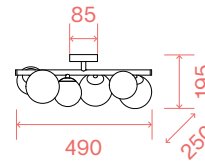


(RECOMMENDED)

LUMEN	CCT	CODE	€
510 lm	3000 K	305486	6
FINISH		CODE	€
White		328423	437
Smoky Grey		328416	437
Amber		328409	437

Bulbs LED G9 3W 3000 K included. Cod. 209043

3,870 Kg
0,0622 m³
G9 max 9 x 15W



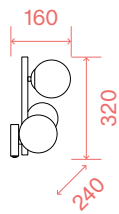
(RECOMMENDED)

LUMEN	CCT	CODE	€
510 lm	3000 K	305486	6
FINISH		CODE	€
White		309279	265
Smoky Grey		309262	265
Amber		327822	265

Bulbs LED G9 3W 3000 K included. Cod. 209043

1,550 Kg
0,0385 m³
G9 max 6 x 15W

WALL

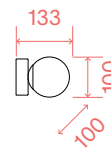


(RECOMMENDED)

LUMEN	CCT	CODE	€
510 lm	3000 K	305486	6
FINISH		CODE	€
White		283784	175
Smoky Grey		271439	175
Amber		322742	175

Bulbs LED G9 3W 3000 K included. Cod. 209043

0,800 Kg
0,0173 m³
G9 max 3 x 15W



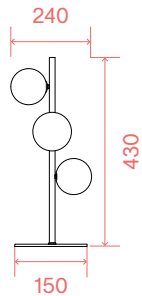
(RECOMMENDED)

LUMEN	CCT	CODE	€
510 lm	3000 K	305486	6
FINISH		CODE	€
White		292410	75
Smoky Grey		292403	75
Amber		317809	75

Bulbs LED G9 3W 3000 K included. Cod. 209043

0,400 Kg
0,0062 m³
G9 max 1 x 15W

TABLE

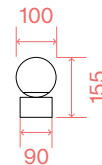


(RECOMMENDED)

LUMEN	CCT	CODE	€
510 lm	3000 K	305486	6
FINISH		CODE	€
White		292472	200
Smoky Grey		292465	200
Amber		322759	200

Bulbs LED G9 3W 3000 K included. Cod. 209043

2,000 Kg
0,0227 m³
G9 max 3 x 15W



(RECOMMENDED)

LUMEN	CCT	CODICE	€
510 lm	3000 K	305486	6
FINISH		CODE	€
White		292458	85
Smoky Grey		292441	85
Amber		317823	85

Bulbs LED G9 3W 3000 K included. Cod. 209043

0,600 Kg
0,0062 m³
G9 max 1 x 15W



PERLAGE

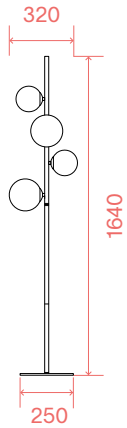
FLOOR



IP20



PHOTO p. 260



(RECOMMENDED)

LUMEN	CCT	CODE	€
510 lm	3000 K	305486	6

FINISH	CODE	€
White	277967	325
Smoky Grey	306988	325
Amber	317816	325

Bulbs LED G9 3W 3000 K included. Cod. 209043



4,800 Kg
0,0612 m³
G9 max 4 x 15W

PIANO

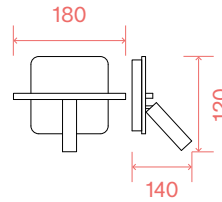
WALL



IP20



PHOTO p. 184



FINISH	CODE	€
White	287317	165
Black	287300	165

LED source 3000 K, 20.000 h life.



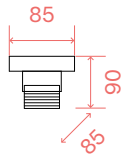
0,800 Kg
0,0047 m³
LED 10W / 1150 lm

SET UP - MOUNTINGS

CEILING



IP20

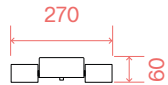


(RECOMMENDED)

LUMEN	CCT	CODICE	€
900 lm	3000 K	123899	3,50

FINISH	CODE	€
White	277288	35

0,300 Kg
0,0010 m³
E27 max 1 x 42W



THREE LIGHTBULBS VERSION

White	348278	58
-------	--------	----

0,850 Kg
0,0041 m³
E27 max 3 x 42W



FOUR LIGHTBULBS VERSION

White	320373	80
-------	--------	----

1,000 Kg
0,0047 m³
E27 max 4 x 42W

SUSPENSION



IP20

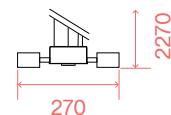


(RECOMMENDED)

LUMEN	CCT	CODE	€
900 lm	3000 K	123899	3,50

FINISH	CODE	€
White	260013	30
Nickel	260044	30
Black	260020	30
Brass	260051	30

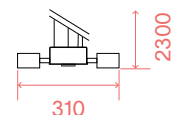
0,350 Kg
0,0019 m³
E27 max 1 x 42W



THREE LIGHTBULBS VERSION

White	348193	102
Nickel	348209	102
Black	348216	102
Brass	348223	102

1,000 Kg
0,0072 m³
E27 max 3 x 42W



FOUR LIGHTBULBS VERSION

White	348230	126
Nickel	348247	126
Black	348254	126
Brass	348261	126

1,200 Kg
0,0081 m³
E27 max 4 x 42W

SET UP - MOUNTINGS

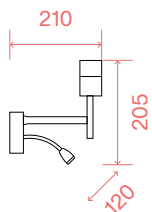
WALL



IP20



PHOTO p. 188

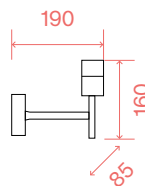


(RECOMMENDED)

LUMEN	CCT	CODE	€
900 lm	3000 K	123899	3,50

FINISH	CODE	€
White	259819	133
Nickel	259833	133
Black	259826	133
Brass	259857	133

0,900 Kg
0,0063 m³
LED 3W / 200 lm



(RECOMMENDED)

LUMEN	CCT	CODE	€
900 lm	3000 K	123899	3,50

FINISH	CODE	€
White	259765	63
Nickel	259796	63
Black	259772	63
Brass	259802	63

0,370 Kg
0,0032 m³
E27 max 1 x 42W



LED source 3000 K
20.000 h life.

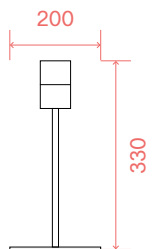
TABLE



IP20



PHOTO p. 220

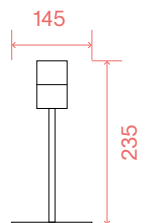


(RECOMMENDED)

LUMEN	CCT	CODE	€
900 lm	3000 K	123899	3,50

FINISH	CODE	€
White	259918	90
Nickel	259949	90
Black	259925	90
Brass	259956	90

1,130 Kg
0,0055 m³
E27 max 1 x 42W



(RECOMMENDED)

LUMEN	CCT	CODE	€
900 lm	3000 K	123899	3,50

FINISH	CODE	€
White	259864	70
Nickel	259895	70
Black	259871	70
Brass	259901	70

0,680 Kg
0,0061 m³
E27 max 1 x 42W

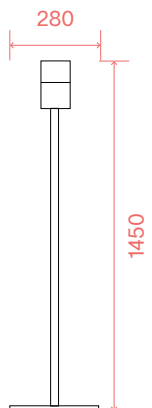
FLOOR



IP20



PHOTO p. 266



(RECOMMENDED)

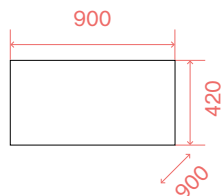
LUMEN	CCT	CODE	€
900 lm	3000 K	123899	3,50

FINISH	CODE	€
White	259963	166
Nickel	259994	166
Black	259970	166
Brass	260006	166

2,640 Kg
0,0251 m³
E27 max 1 x 42W

SET UP - SHADES

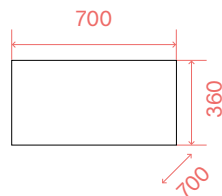
SET UP



2,000 Kg
0,1384 m³

(COMPATIBLE WITH SUSPENSION AND CEILING VERSIONS)

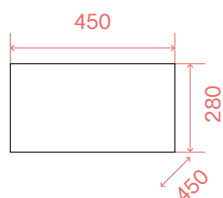
FINISH	CODE	€
White	345918	172
Dove Grey	345932	172
Black	345925	172
Beige	339269	172
Wood	339276	172



1,260 Kg
0,0674 m³

(COMPATIBLE WITH SUSPENSION AND CEILING VERSIONS)

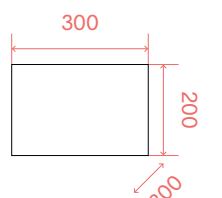
FINISH	CODE	€
White	260471	138
Dove Grey	304632	138
Black	270029	138
Beige	260488	138
Wood	345901	138



0,770 Kg
0,0221 m³

(COMPATIBLE WITH SUSPENSION, CEILING AND FLOOR VERSIONS)

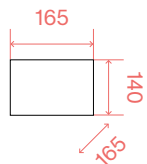
FINISH	CODE	€
White	260457	92
Dove Grey	304625	92
Black	270012	92
Beige	260464	92
Wood	345895	92



0,460 Kg
0,0228 m³

(COMPATIBLE WITH CEILING, WALL AND TABLE VERSIONS)

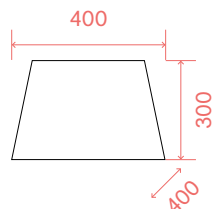
FINISH	CODE	€
White	260433	63
Dove Grey	304618	63
Black	270005	63
Beige	260440	63
Wood	345888	63



0,120 Kg
0,0180 m³

(COMPATIBLE WITH WALL AND TABLE VERSIONS)

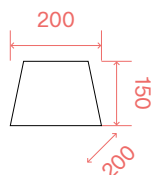
FINISH	CODE	€
White	260327	32
Dove Grey	304601	32
Black	269986	32
Beige	260334	32
Wood	345871	32



0,460 Kg
0,0709 m³

(COMPATIBLE WITH FLOOR VERS.)

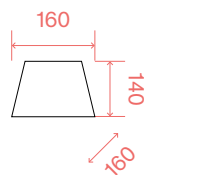
FINISH	CODE	€
White	260136	75
Dove Grey	304120	75
Black	260235	75
Beige	260242	75
Wood	345963	75



0,130 Kg
0,0180 m³

(COMPATIBLE WITH WALL AND TABLE VERSIONS)

FINISH	CODE	€
White	260068	34
Dove Grey	304113	34
Black	260075	34
Beige	260082	34
Wood	345956	34



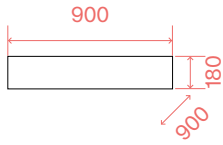
0,110 Kg
0,0180 m³

(COMPATIBLE WITH WALL AND TABLE VERSIONS)

FINISH	CODE	€
White	260341	29
Dove Grey	293004	29
Black	270036	29
Beige	260358	29
Wood	345949	29

SET UP - SHADES

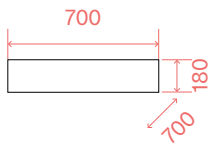
SET UP SLIM



(COMPATIBLE WITH SUSPENSION AND CEILING VERSIONS)

FINISH	CODE	€
White	346069	138
Dove Grey	339283	138
Black	346083	138
Beige	346052	138
Wood	346076	138

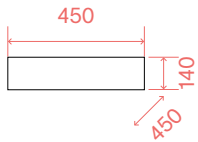
1,200 Kg
0,1903 m³



(COMPATIBLE WITH SUSPENSION AND CEILING VERSIONS)

FINISH	CODE	€
White	339290	115
Dove Grey	346045	115
Black	346038	115
Beige	346014	115
Wood	346021	115

0,750 Kg
0,1172 m³

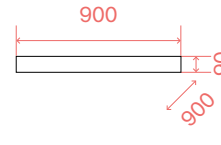


(COMPATIBLE WITH SUSPENSION AND CEILING VERSIONS)

FINISH	CODE	€
White	345987	80
Dove Grey	346007	80
Black	345994	80
Beige	345970	80
Wood	339306	80

0,440 Kg
0,0415 m³

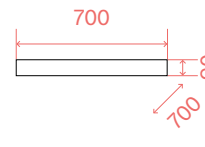
SET UP ULTRASLIM



(COMPATIBLE WITH SUSPENSION AND CEILING VERSIONS)

FINISH	CODE	€
White	346182	126
Dove Grey	346205	126
Black	339313	126
Beige	346175	126
Wood	346199	126

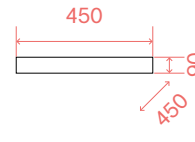
0,800 Kg
0,1124 m³



(COMPATIBLE WITH SUSPENSION AND CEILING VERSIONS)

FINISH	CODE	€
White	346144	103
Dove Grey	346168	103
Black	346151	103
Beige	346137	103
Wood	339320	103

0,600 Kg
0,0613 m³

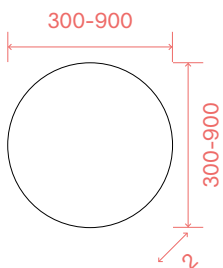


(COMPATIBLE WITH SUSPENSION AND CEILING VERSIONS)

FINISH	CODE	€
White	339337	69
Dove Grey	346120	69
Black	346113	69
Beige	346090	69
Wood	346106	69

0,500 Kg
0,0265 m³

ACRYLIC DISCS



(COMPATIBLE WITH SUSPENSION AND CEILING VERSIONS)

FINISH	MEASURE	WEIGHT	VOLUME	CODE	€
Clear	(D90)	0,500 Kg	0,0423 m ³	339252	80
Clear	(D70)	0,700 Kg	0,0259 m ³	270050	58
Clear	(D45)	0,280 Kg	0,0108 m ³	270043	35
Clear	(D30)	0,100 Kg	0,0061 m ³	346847	17

SMARTIES

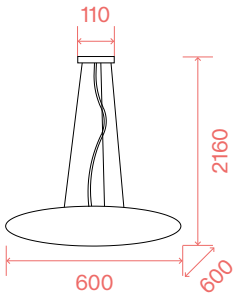
SUSPENSION



IP20

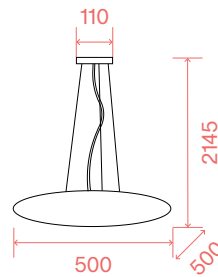


PHOTO p. 100



(RECOMMENDED)

LUMEN	CCT	CODE	€
340 lm	3000 K	101286	2
FINISH		CODE	€
White		031996	290

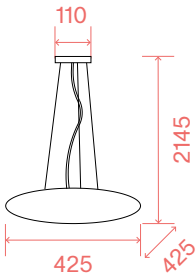


(RECOMMENDED)

LUMEN	CCT	CODE	€
340 lm	3000 K	101286	2
FINISH		CODE	€
White		032009	200

5,280 Kg
0,1479 m³
E27 max 5 x 42W

3,740 Kg
0,1009 m³
E27 max 3 x 42W



(RECOMMENDED)

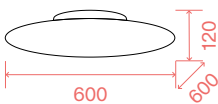
LUMEN	CCT	CODE	€
340 lm	3000 K	101286	2
FINISH		CODE	€
White		032016	175

2,930 Kg
0,0645 m³
E27 max 3 x 42W

CEILING



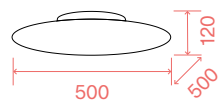
IP20



(RECOMMENDED)

LUMEN	CCT	CODE	€
340 lm	3000 K	101286	2
FINISH		CODE	€
White		032023	280

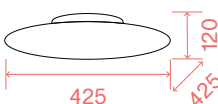
4,690 Kg
0,1480 m³
E27 max 3 x 42W



(RECOMMENDED)

LUMEN	CCT	CODE	€
340 lm	3000 K	101286	2
FINISH		CODE	€
White		032030	195

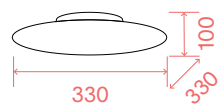
3,070 Kg
0,1009 m³
E27 max 3 x 42W



(RECOMMENDED)

LUMEN	CCT	CODE	€
340 lm	3000 K	101286	2
FINISH		CODE	€
White		032047	170

2,810 Kg
0,0599 m³
E27 max 2 x 42W



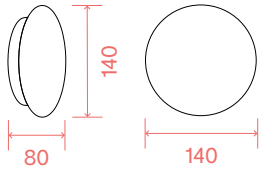
(RECOMMENDED)

LUMEN	CCT	CODE	€
340 lm	3000 K	101286	2
FINISH		CODE	€
White		009223	115

1,440 Kg
0,0454 m³
E27 max 1 x 42W

SMARTIES

WALL / CEILING

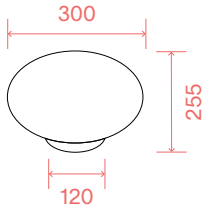


(RECOMMENDED)

LUMEN	CCT	CODE	€
510 lm	3000 K	305486	6
FINISH		CODE	€
White		014814	46

0,440 Kg
0,0079 m³
G9 max 1 x 15W

Bulbs LED G9 3W 3000 K included. Cod. 209043



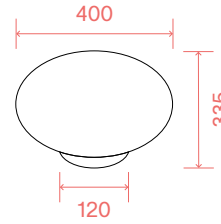
(RECOMMENDED)

LUMEN	CCT	CODE	€
430 lm	3000 K	101279	2
FINISH		CODE	€
White		327907	130

1,400 Kg
0,0392 m³
E27 max 1 x 42W



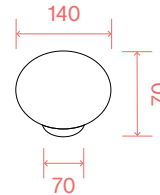
TABLE



(RECOMMENDED)

LUMEN	CCT	CODE	€
430 lm	3000 K	101279	2
FINISH		CODE	€
White		827914	190

2,660 Kg
0,0810 m³
E27 max 1 x 42W



(RECOMMENDED)

LUMEN	CCT	CODE	€
510 lm	3000 K	305486	6
FINISH		CODE	€
White		032078	50

0,470 Kg
0,0079 m³
G9 max 1 x 15W

Bulbs LED G9 3W 3000 K included. Cod. 209043

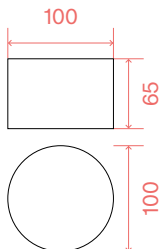


SPIKE

CEILING



PHOTO p. 138

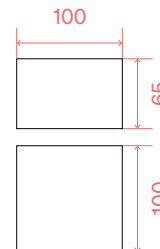


(RECOMMENDED)

LUMEN	CCT	CODE	€
910 lm	3000 K	123936	5
FINISH		CODE	€
White		277417	80
Chrome		310886	80
Black		278704	80
Brass		285238	80
Copper		310893	80

0,240 Kg
0,0017 m³
GX53 max 1 x 15W

Bulbs LED GX53 9W 3000 K included. Cod. 123936



(RECOMMENDED)

LUMEN	CCT	CODE	€
910 lm	3000 K	123936	5
FINISH		CODE	€
White		317489	85
Chrome		328799	85
Black		317496	85
Brass		317502	85
Copper		328812	85

0,220 Kg
0,0014 m³
GX53 max 1 x 15W

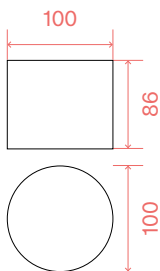
Bulbs LED GX53 9W 3000 K included. Cod. 123936

SPIKE LED

CEILING



IP20



FINISH	CODE	€
White	345468	40
Black	336008	40
Brass	345475	40

LED source 3000 K, 25.000 h life.

0,340 Kg
0,0012 m³
LED 10W / 1100 lm

ULTRATHIN

SUSPENSION



IP20

↑ PHOTO p. 106



ON-OFF

FINISH	CODE	€
White	142906	143
Chrome	164878	143
Black	142913	143
Brass	339733	143

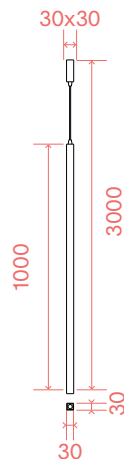
DALI/PUSH

FINISH	CODE	€
Black	321783	205

LED source 3000 K, 30.000 h life.

0,670 Kg
0,0036 m³
LED 11,5W / 1150 lm
51°

DALI/PUSH
1,100 Kg
0,0070 m³
LED 12W / 1150 lm



ON-OFF

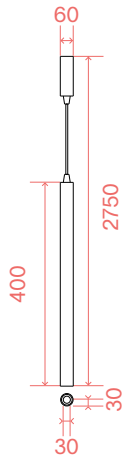
FINISH	CODE	€
White	194172	209
Black	194196	209
Brass	339757	209

LED source 3000 K, 30.000 h life.

0,860 Kg
0,0036 m³
LED 11,5W / 1150 lm / 51°

ULTRATHIN

SUSPENSION



ON-OFF

FINISH	CODE	€
White	156682	108
Chrome	187662	108
Black	156699	108
Brass	339726	108

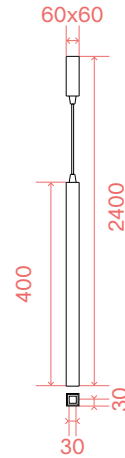
DALI/PUSH

FINISH	CODE	€
Black	321813	176

LED source 3000 K, 30.000 h life.

0,460 Kg
0,0036 m³
LED 11,5W / 1150 lm
51°

DALI/PUSH
0,760 Kg
0,0037 m³
LED 12W / 1150 lm



ON-OFF

FINISH	CODE	€
White	194189	170
Black	194202	170
Brass	339740	170

LED source 3000 K, 30.000 h life.

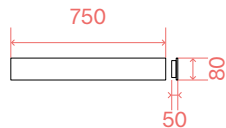
0,450 Kg
0,0019 m³
LED 11,5W / 1150 lm / 51°

ZIG ZAG

WALL



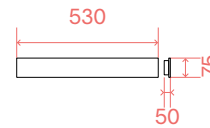
IP20 [↑ PHOTO p. 192](#)



FINISH	CCT	CODE	€
White	2700 K	342665	140
White	3000 K	277219	140
White	4000 K	277257	140
Black	3000 K	277226	140
Brass	3000 K	287072	140

LED source 2700/3000/4000 K, 50.000 h life.

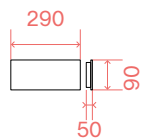
1,040 Kg
0,0047 m³
LED 30W
2950/4550 lm



FINISH	CCT	CODE	€
White	2700 K	342658	110
White	3000 K	179308	110
White	4000 K	277240	110
Black	3000 K	179322	110
Brass	3000 K	282138	110

LED source 2700/3000/4000 K, 50.000 h life.

0,760 Kg
0,0034 m³
LED 23W
2800/3200 lm



FINISH	CCT	CODE	€
White	2700 K	342641	95
White	3000 K	179292	95
White	4000 K	277233	95
Black	3000 K	179315	95
Brass	3000 K	282121	95

LED source 2700/3000/4000 K, 50.000 h life.

0,550 Kg
0,0020 m³
LED 12,5W
1450/1600 lm

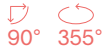
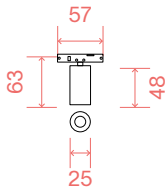
DEVA TRACK

SYSTEMS



IP20 MacAdam: SDCM 3 CRI: ≥90 LED LIFE: 30.000 h

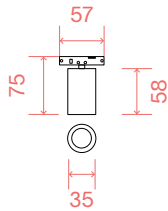
↑ PHOTO p. 272



0,030 Kg
0,0002 m³

LED COB OSRAM

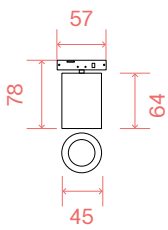
POWER	BEAM	CONTROL	LUMEN	CCT	FINISH	CODE	€
2,5 W	37°	On-Off	150 lm	3000 K	White	332772	35
2,5 W	37°	On-Off	150 lm	3000 K	Black	332765	35



0,050 Kg
0,0003 m³

LED COB

POWER	BEAM	CONTROL	LUMEN	CCT	FINISH	CODE	€
4,5 W	34°	On-Off	450 lm	3000 K	White	332796	40
4,5 W	34°	On-Off	450 lm	3000 K	Black	332789	40



0,090 Kg
0,0004 m³

LED COB

POWER	BEAM	CONTROL	LUMEN	CCT	FINISH	CODE	€
8 W	30°	On-Off	750 lm	3000 K	White	332826	45
8 W	30°	On-Off	750 lm	3000 K	Black	332819	45

LENS

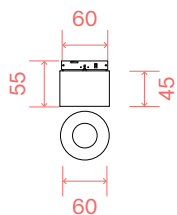
REQUIRED	BEAM	MODEL	CODE	€
No	15°	DEVA 2,5 W	332543	5
No	15°	DEVA 4,5 W	332505	5
No	15°	DEVA 8 W	332468	5

DEVA DISC

SYSTEMS



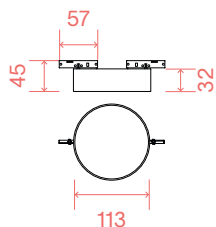
IP20 MacAdam: SDCM 3 CRI: ≥90 LED LIFE: 30.000 h



LED COB

POWER	BEAM	CONTROL	LUMEN	CCT	FINISH	CODE	€
5 W	38°	On-Off	500 lm	3000 K	White	332857	40
5 W	38°	On-Off	500 lm	3000 K	Black	332840	40

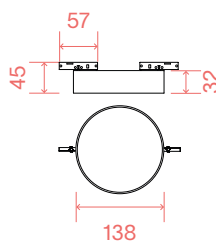
0,110 Kg
0,0004 m³



LED SMD

POWER	BEAM	CONTROL	LUMEN	CCT	FINISH	CODE	€
10 W	98°	On-Off	1100 lm	3000 K	White	332888	45
10 W	98°	On-Off	1100 lm	3000 K	Black	332864	45

0,330 Kg
0,0020 m³



LED SMD

POWER	BEAM	CONTROL	LUMEN	CCT	FINISH	CODE	€
15 W	98°	On-Off	1750 lm	3000 K	White	332918	55
15 W	98°	On-Off	1750 lm	3000 K	Black	332901	55

0,430 Kg
0,0020 m³

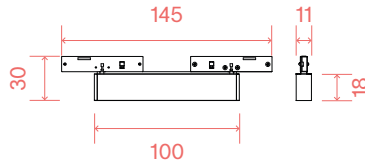
DEVA ACCENT

SYSTEMS



IP20 MacAdam: SDCM 3 CRI: ≥90 LED LIFE: 30.000 h

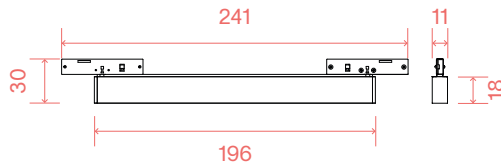
0,070 Kg
0,0002 m³



LED SMD OSRAM

POWER	BEAM	LUMEN	CCT	FINISH	CODE	€
5 W	34°	350 lm	3000 K	Black	332758	30

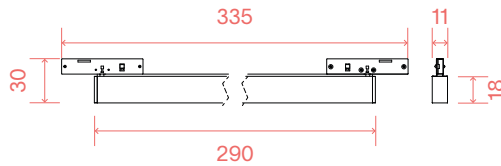
0,140 Kg
0,0003 m³



LED SMD OSRAM

POWER	BEAM	LUMEN	CCT	FINISH	CODE	€
10 W	34°	900 lm	3000 K	Black	332734	40

0,230 Kg
0,0005 m³



LED SMD OSRAM

POWER	BEAM	LUMEN	CCT	FINISH	CODE	€
14 W	34°	1400 lm	3000 K	Black	332710	50

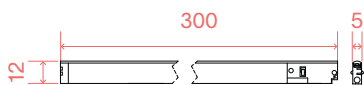
DEVA WIDE INNER

SYSTEMS



IP20 MacAdam: SDCM 3 CRI: ≥90 LED LIFE: 30.000 h

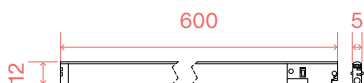
0,020 Kg
0,0001 m³



LED SMD

POWER	BEAM	LUMEN	CCT	FINISH	CODE	€
6 W	100°	700 lm	3000 K	Black	332949	25

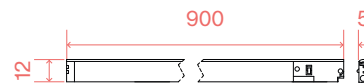
0,080 Kg
0,0003 m³



LED SMD

POWER	BEAM	LUMEN	CCT	FINISH	CODE	€
11 W	100°	1400 lm	3000 K	Black	332925	35

0,130 Kg
0,0004 m³



LED SMD

POWER	BEAM	LUMEN	CCT	FINISH	CODE	€
16 W	100°	2100 lm	3000 K	Black	332895	50

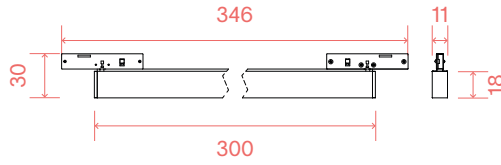
DEVA WIDE OUTER

SYSTEMS



IP20 MacAdam: SDCM 3 CRI: ≥90 LED LIFE: 30.000 h

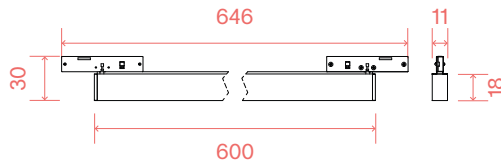
0,130 Kg
0,0005 m³



LED SMD

POWER	BEAM	LUMEN	CCT	FINISH	CODE	€
8 W	100°	900 lm	3000 K	Black	332871	25

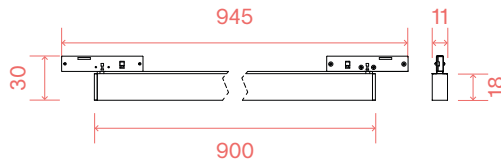
0,330 Kg
0,0008 m³



LED SMD

POWER	BEAM	LUMEN	CCT	FINISH	CODE	€
12 W	100°	1350 lm	3000 K	Black	332833	35

0,310 Kg
0,0012 m³



LED SMD

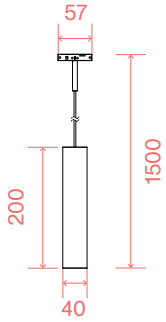
POWER	BEAM	LUMEN	CCT	FINISH	CODE	€
21 W	100°	2700 lm	3000 K	Black	332802	50

DEVA PENDANT

SYSTEMS



IP20 MacAdam: SDCM 3 CRI: ≥ 90 LED LIFE: 30.000 h



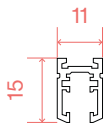
LED COB BRIDGELUX

POWER	BEAM	LUMEN	CCT	FINISH	CODE	€
6 W	34°	550 lm	3000 K	Black	332932	45

0,280 Kg
0,0009 m³

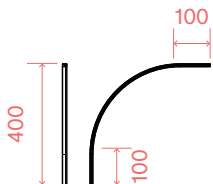
DEVA - SURFACE

SYSTEMS



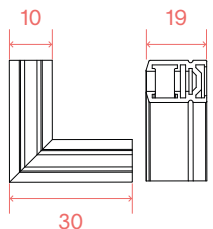
PROFILE SURFACE

LENGTH	WEIGHT	VOLUME	FINISH	CODE	€
1000 mm	0,280 Kg	0,0003 m ³	Black	332475	20
2000 mm	0,470 Kg	0,0007 m ³	Black	332482	40



SURFACE CORNER ROUND

WEIGHT	VOLUME	CONTROL	FINISH	CODE	€
0,1700 Kg	0,0014 m ³	On-Off	Black	339375	91



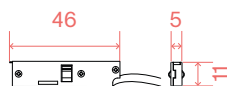
SURFACE CORNER L

WEIGHT	VOLUME	CONTROL	FINISH	CODE	€
0,020 Kg	0,0004 m ³	On-Off	Black	339382	41



LINEAR CONNECTOR (REQUIRED - 1 KIT X LINEAR CONNECTION)

WEIGHT	VOLUME	CONTROL	FINISH	CODE	€
0,010 Kg	0,0005 m ³	On-Off	Black	339368	18



MAIN CONNECTOR (REQUIRED - 1 KIT X POWER SOURCE MAX 140 W)

WEIGHT	VOLUME	CONTROL	FINISH	CODE	€
0,060 Kg	0,0002 m ³	On-Off	Black	332581	15

Cable length
1500 mm

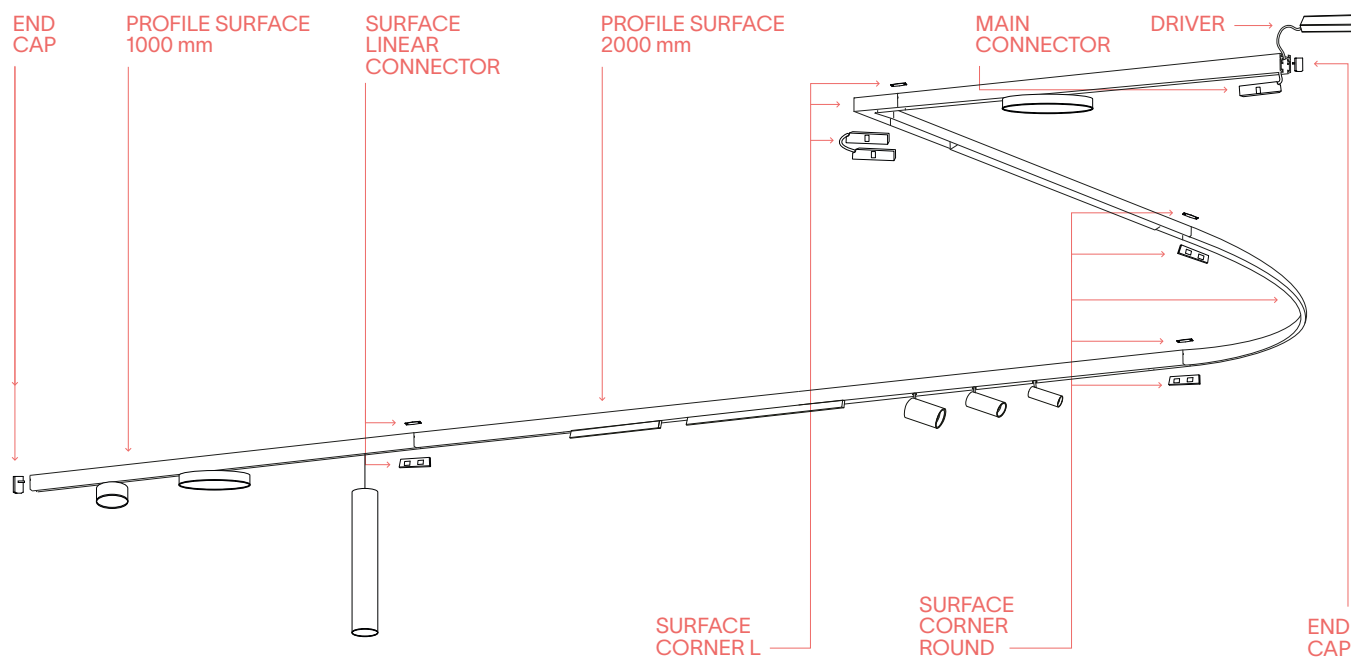
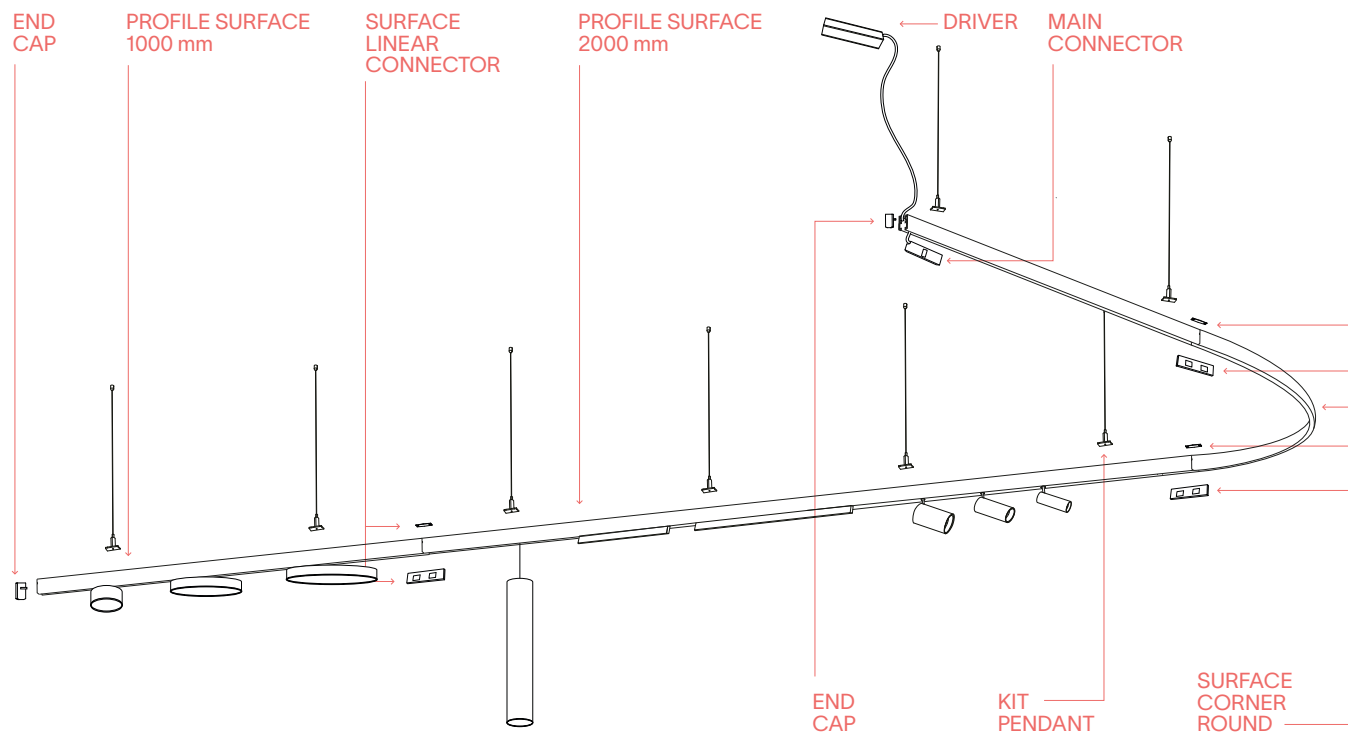
DRIVER ON/OFF (REQUIRED)

POWER	OUTPUT	MEASURE (L X H X W)	CODE	€
75 W	24 Vdc	168 x 30 x 38 mm	332659	65
150 W	24 Vdc	227 x 30 x 38 mm	332628	95

	REQUIRED	MEASURE (L X H X W)	FINISH	CODE	€
END CAP (2 pcs. incl.)	YES	10 x 15 x 7 mm	Black	332635	3
KIT PENDANT	YES	7,7 x 2049 x 7 mm	Black	332703	15

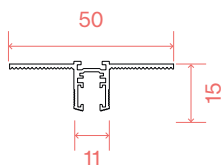
DEVA - SURFACE - ASSEMBLY PLANS

SYSTEMS



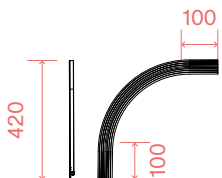
DEVA - RECESSED

SYSTEMS



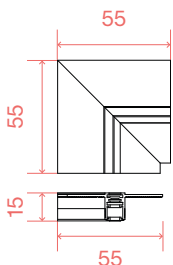
PROFILE RECESSED

LENGTH	WEIGHT	VOLUME	FINISH	CODE	€
1000 mm	0,370 Kg	0,0017 m ³	Black	332529	20
2000 mm	0,670 Kg	0,0034 m ³	Black	332536	40



RECESSED CORNER ROUND

WEIGHT	VOLUME	CONTROL	FINISH	CODE	€
0,270 Kg	0,0023 m ³	On-Off	Black	339405	91



RECESSED CORNER L

WEIGHT	VOLUME	CONTROL	FINISH	CODE	€
0,030 Kg	0,0003 m ³	On-Off	Black	339412	41



RECESSED LINEAR CONNECTOR (REQUIRED - 1 KIT X LINEAR CONNECTION)

WEIGHT	VOLUME	CONTROL	FINISH	CODE	€
0,020 Kg	0,0005 m ³	On-Off	Black	339399	18



MAIN CONNECTOR (REQUIRED - 1 KIT X POWER SOURCE MAX 140 W)

WEIGHT	VOLUME	CONTROL	FINISH	CODE	€
0,060 Kg	0,0002 m ³	On-Off	Black	332581	15

Cable length
1500 mm

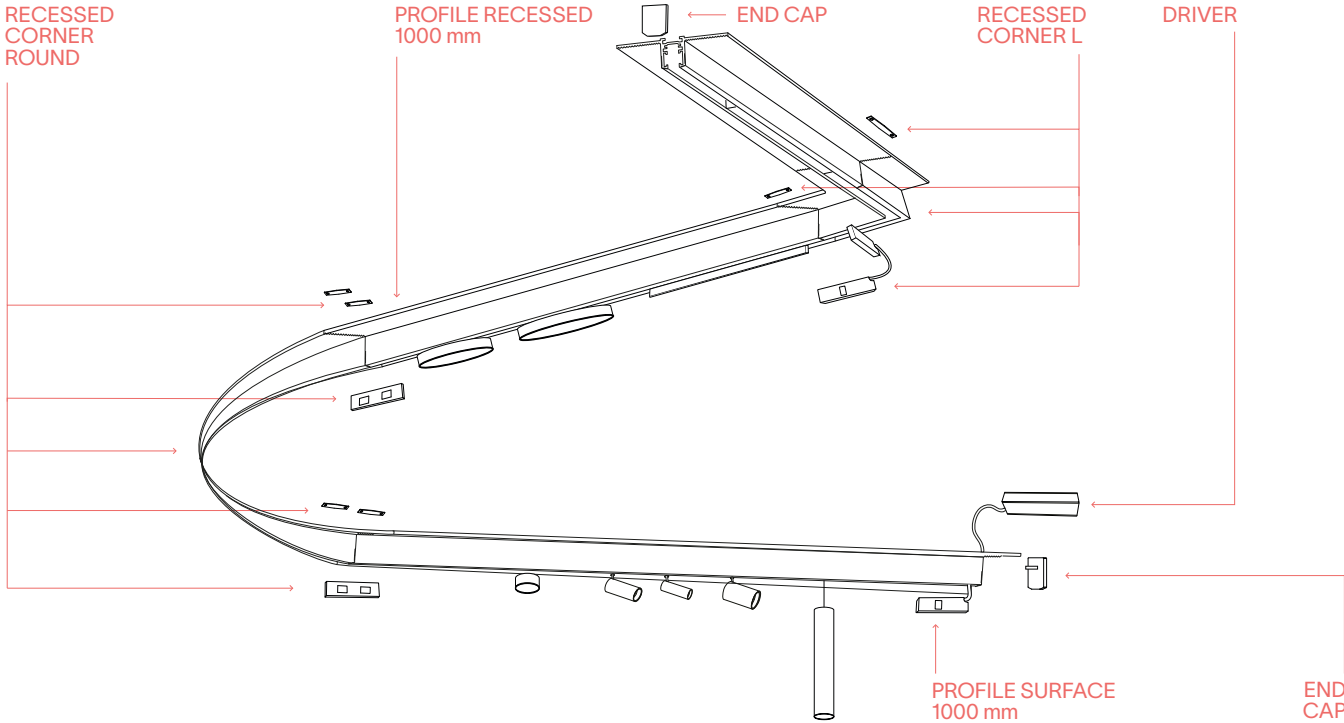
DRIVER ON/OFF (REQUIRED)

POWER	OUTPUT	MEASURE (L X H X W)	CODE	€
75 W	24 Vdc	168 x 30 x 38 mm	332659	65
150 W	24 Vdc	227 x 30 x 38 mm	332628	95

REQUIRED	MEASURE (L X H X W)	FINISH	CODE	€
END CAP (2 pcs. incl.) YES	10 x 15 x 7 mm	Black	332635	3

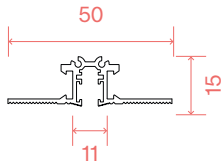
DEVA - RECESSED - ASSEMBLY PLANS

SYSTEMS



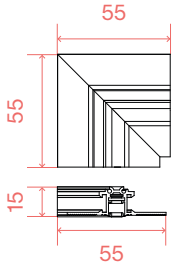
DEVA - RECESSED EASY

SYSTEMS



PROFILE RECESSED EASY

LENGTH	WEIGHT	VOLUME	FINISH	CODE	€
1000 mm	0,370 Kg	0,0017 m ³	Black	332499	25
2000 mm	0,870 Kg	0,0034 m ³	Black	332512	50



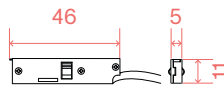
RECESSED EASY CORNER L

WEIGHT	VOLUME	CONTROL	FINISH	CODE	€
0,030 Kg	0,0003 m ³	On-Off	Black	339429	41



RECESSED LINEAR CONNECTOR (REQUIRED - 1 KIT X LINEAR CONNECTION)

WEIGHT	VOLUME	CONTROL	FINISH	CODE	€
0,020 Kg	0,0005 m ³	On-Off	Black	339399	18



MAIN CONNECTOR (REQUIRED - 1 KIT X POWER SOURCE MAX 140 W)

WEIGHT	VOLUME	CONTROL	FINISH	CODE	€
0,060 Kg	0,0002 m ³	On-Off	Black	332581	15

Cable length
1500 mm

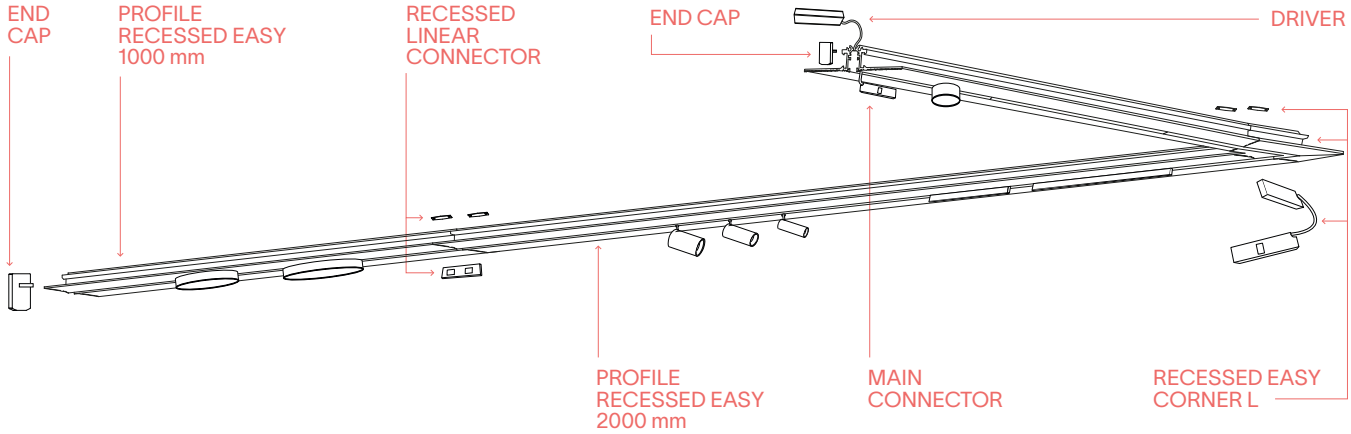
DRIVER ON/OFF (REQUIRED)

POWER	OUTPUT	MEASURE (L X H X W)	CODE	€
75 W	24 Vdc	168 x 30 x 38 mm	332659	65
150 W	24 Vdc	227 x 30 x 38 mm	332628	95

	REQUIRED	MEASURE (L X H X W)	FINISH	CODE	€
END CAP (2 pcs. incl.)	YES	10 x 15 x 7 mm	Black	332635	3

DEVA - RECESSED EASY - ASSEMBLY PLANS

SYSTEMS



DISPLAY ACCENT

PROJECTORS

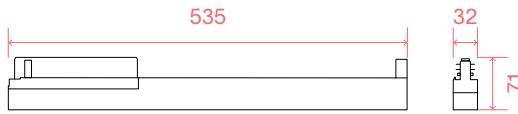


IP20 MacAdam: SDCM 3 UGR: <16 CRI: ≥90 LED LIFE: 50.000 h



↑ PHOTO p. 285

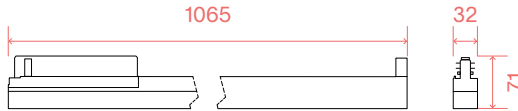
0,750 Kg
0,0055 m³



LED SMD SAMSUNG (DRIVER ON/OFF INCLUDED)

POWER	BEAM	LUMEN	CCT	TRACK	FINISH	CODE	€
14 W	60°	1250 lm	2700 K	3-Phase	White	339894	242
14 W	60°	1250 lm	2700 K	3-Phase	Black	339887	242
14 W	60°	1350 lm	3000 K	3-Phase	White	283593	242
14 W	60°	1350 lm	3000 K	3-Phase	Black	283609	242
14 W	60°	1600 lm	4000 K	3-Phase	White	283616	242
14 W	60°	1600 lm	4000 K	3-Phase	Black	283623	242

1,120 Kg
0,0112 m³



LED SMD SAMSUNG (DRIVER ON/OFF INCLUDED)

POWER	BEAM	LUMEN	CCT	TRACK	FINISH	CODE	€
28 W	60°	2700 lm	3000 K	3-Phase	White	283524	380
28 W	60°	2700 lm	3000 K	3-Phase	Black	276267	380
28 W	60°	3200 lm	4000 K	3-Phase	White	283531	380
28 W	60°	3200 lm	4000 K	3-Phase	Black	283548	380

1,570 Kg
0,0173 m³



LED SMD SAMSUNG (DRIVER ON/OFF INCLUDED)

POWER	BEAM	LUMEN	CCT	TRACK	FINISH	CODE	€
42 W	60°	3750 lm	3000 K	3-Phase	White	283555	525
42 W	60°	3750 lm	3000 K	3-Phase	Black	283562	525
42 W	60°	4350 lm	4000 K	3-Phase	White	283579	525
42 W	60°	4350 lm	4000 K	3-Phase	Black	283586	525

DISPLAY WIDE

PROJECTORS

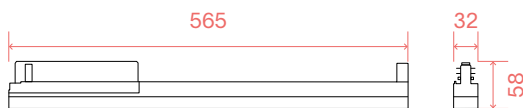


IP20 MacAdam: SDCM 3 CRI: ≥90 LED LIFE: 50.000 h



↑ PHOTO p. 278

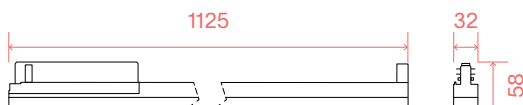
0,550 Kg
0,0035 m³



LED SMD SAMSUNG (DRIVER ON/OFF INCLUDED)

POWER	BEAM	LUMEN	CCT	TRACK	FINISH	CODE	€
21 W	125°	2100 lm	2700 K	3-Phase	White	340012	200
21 W	125°	2100 lm	2700 K	3-Phase	Black	340005	200
21 W	125°	2500 lm	3000 K	3-Phase	White	283753	200
21 W	125°	2500 lm	3000 K	3-Phase	Black	283760	200
21 W	125°	2800 lm	4000 K	3-Phase	White	276274	200
21 W	125°	2800 lm	4000 K	3-Phase	Black	283777	200

0,090 Kg
0,0047 m³



LED SMD SAMSUNG (DRIVER ON/OFF INCLUDED)

POWER	BEAM	LUMEN	CCT	TRACK	FINISH	CODE	€
40 W	125°	4200 lm	2700 K	3-Phase	White	340036	305
40 W	125°	4200 lm	2700 K	3-Phase	Black	340029	305
40 W	125°	4600 lm	3000 K	3-Phase	White	283722	305
40 W	125°	4600 lm	3000 K	3-Phase	Black	283050	305
40 W	125°	5050 lm	4000 K	3-Phase	White	283739	305
40 W	125°	5050 lm	4000 K	3-Phase	Black	283746	305

DISPLAY UGR

PROJECTORS

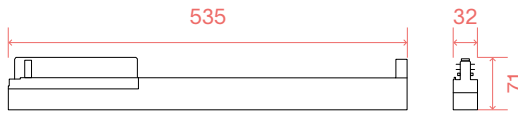


IP20 MacAdam: SDCM 3 UGR: <22 CRI: ≥90 LED LIFE: 50.000 h



↑ PHOTO p. 280

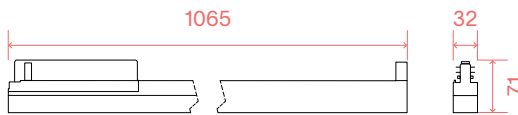
0,400 Kg
0,0064 m³



LED SMD SAMSUNG (DRIVER ON/OFF INCLUDED)

POWER	BEAM	LUMEN	CCT	TRACK	FINISH	CODE	€
14 W	70°	1750 lm	3000 K	3-Phase	White	283685	212
14 W	70°	1750 lm	3000 K	3-Phase	Black	283692	212
14 W	70°	1800 lm	4000 K	3-Phase	White	283708	212
14 W	70°	1800 lm	4000 K	3-Phase	Black	283715	212

1,120 Kg
0,0112 m³



LED SMD SAMSUNG (DRIVER ON/OFF INCLUDED)

POWER	BEAM	LUMEN	CCT	TRACK	FINISH	CODE	€
25 W	70°	3550 lm	3000 K	3-Phase	White	283647	335
25 W	70°	3550 lm	3000 K	3-Phase	Black	283630	335
25 W	70°	3650 lm	4000 K	3-Phase	White	276281	335
25 W	70°	3650 lm	4000 K	3-Phase	Black	283258	335

1,570 Kg
0,0173 m³



LED SMD SAMSUNG (DRIVER ON/OFF INCLUDED)

POWER	BEAM	LUMEN	CCT	TRACK	FINISH	CODE	€
40 W	70°	5350 lm	3000 K	3-Phase	White	283654	470
40 W	70°	5350 lm	3000 K	3-Phase	Black	283067	470
40 W	70°	5500 lm	4000 K	3-Phase	White	283661	470
40 W	70°	5500 lm	4000 K	3-Phase	Black	283678	470

EGO TRACK SINGLE

SYSTEMS

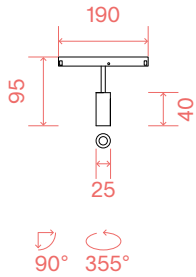


IP20 MacAdam: SDCM 3 CRI: ≥90 LED LIFE: 50.000 h



↑ PHOTO p. 288

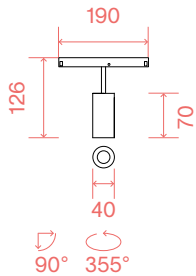
LED SMD OSRAM



0,150 Kg
0,0017 m³

POWER	BEAM	CONTROL	LUMEN	CCT	FINISH	CODE	€
3 W	30°	On-Off	200 lm	3000 K	White	282978	80
3 W	30°	On-Off	200 lm	3000 K	Black	257617	80
3 W	30°	On-Off	220 lm	4000 K	Black	317977	80
3 W	30°	1-10V	200 lm	3000 K	White	303673	100
3 W	30°	1-10V	200 lm	3000 K	Black	303666	100
3 W	30°	DALI	200 lm	3000 K	White	286402	125
3 W	30°	DALI	200 lm	3000 K	Black	286396	125

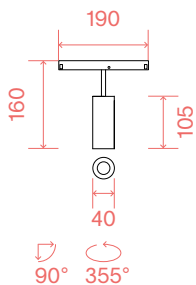
LED COB CITIZEN



0,200 Kg
0,0017 m³

POWER	BEAM	CONTROL	LUMEN	CCT	FINISH	CODE	€
8 W	30°	On-Off	720 lm	2700 K	Black	340388	95
8 W	30°	On-Off	850 lm	3000 K	White	282985	95
8 W	30°	On-Off	850 lm	3000 K	Black	257631	95
8 W	30°	On-Off	900 lm	4000 K	Black	317984	95
8 W	30°	1-10V	850 lm	3000 K	White	303697	110
8 W	30°	1-10V	850 lm	3000 K	Black	303680	110
8 W	30°	DALI	720 lm	2700 K	Black	340364	135
8 W	30°	DALI	850 lm	3000 K	White	286426	135
8 W	30°	DALI	850 lm	3000 K	Black	286419	135

LED COB CITIZEN



0,300 Kg
0,0017 m³

POWER	BEAM	CONTROL	LUMEN	CCT	FINISH	CODE	€
12 W	30°	On-Off	1000 lm	2700 K	Black	340425	95
12 W	30°	On-Off	1200 lm	3000 K	White	282992	95
12 W	30°	On-Off	1200 lm	3000 K	Black	257655	95
12 W	30°	On-Off	1250 lm	4000 K	Black	321967	95
12 W	30°	1-10V	1200 lm	3000 K	White	303710	110
12 W	30°	1-10V	1200 lm	3000 K	Black	303703	110
12 W	30°	DALI	1000 lm	2700 K	Black	340401	140
12 W	30°	DALI	1200 lm	3000 K	White	286440	140
12 W	30°	DALI	1200 lm	3000 K	Black	286433	140

EGO TRACK SINGLE

SYSTEMS

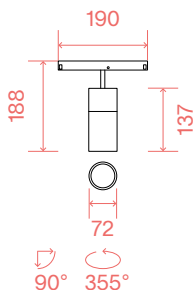


IP20 MacAdam: SDCM 3 CRI: ≥90 LED LIFE: 50.000 h



↑ PHOTO p. 288

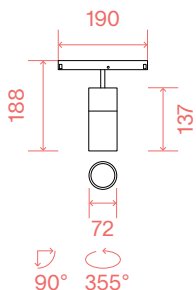
LED COB CITIZEN



0,800 Kg
0,0035 m³

POWER	BEAM	CONTROL	LUMEN	CCT	FINISH	CODE	€
19 W	35°	On-Off	2200 lm	3000 K	White	307558	140
19 W	35°	On-Off	2200 lm	3000 K	Black	305608	140
19 W	35°	On-Off	2350 lm	4000 K	Black	321998	140
19 W	35°	1-10V	2200 lm	3000 K	White	307527	155
19 W	35°	1-10V	2200 lm	3000 K	Black	307510	155
19 W	35°	DALI	2200 lm	3000 K	White	307541	185
19 W	35°	DALI	2200 lm	3000 K	Black	307534	185

LED COB CITIZEN



0,800 Kg
0,0035 m³

POWER	BEAM	CONTROL	LUMEN	CCT	FINISH	CODE	€
26 W	35°	On-Off	3050 lm	3000 K	White	307602	140
26 W	35°	On-Off	3050 lm	3000 K	Black	305615	140
26 W	35°	On-Off	3150 lm	4000 K	Black	317991	140
26 W	35°	1-10V	3050 lm	3000 K	White	307572	155
26 W	35°	1-10V	3050 lm	3000 K	Black	307565	155
26 W	35°	DALI	3050 lm	3000 K	White	307596	185
26 W	35°	DALI	3050 lm	3000 K	Black	307589	185

	MODEL	REQUIRED	BEAM	FINISH	CODE	€
LENS	3W	NO	18°	Clear	332062	5
LENS	3W	NO	45°	Clear	332079	5
LENS	8/12W	NO	18°	Clear	332086	5
LENS	8/12W	NO	45°	Clear	332083	5
LENS	19/26W	NO	20°	Clear	332109	10
LENS	19/26W	NO	55°	Clear	332116	10
FILTER HONEYCOMB	3W	NO		Black	260853	5
FILTER HONEYCOMB	8/12W	NO		Black	260860	5

EGO TRACK DOUBLE

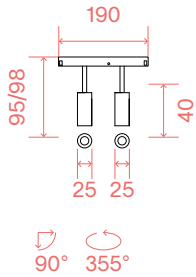
SYSTEMS



IP20 MacAdam: SDCM 3 CRI: ≥90 LED LIFE: 50.000 h



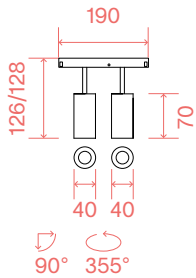
LED SMD OSRAM



0,220 Kg
0,0017 m³

POWER	BEAM	CONTROL	LUMEN	CCT	FINISH	CODE	€
5 W	30°	On-Off	400 lm	3000 K	White	282947	100
5 W	30°	On-Off	400 lm	3000 K	Black	257624	100
5 W	30°	On-Off	430 lm	4000 K	Black	321714	100
5 W	30°	1-10V	400 lm	3000 K	White	303611	115
5 W	30°	1-10V	400 lm	3000 K	Black	303604	115
5 W	30°	DALI	400 lm	3000 K	White	286341	145
5 W	30°	DALI	400 lm	3000 K	Black	286334	145

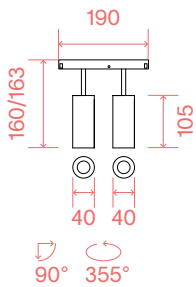
LED COB CITIZEN



0,450 Kg
0,0017 m³

POWER	BEAM	CONTROL	LUMEN	CCT	FINISH	CODE	€
16 W	30°	On-Off	1400 lm	2700 K	Black	340265	135
16 W	30°	On-Off	1500 lm	3000 K	White	282954	135
16 W	30°	On-Off	1500 lm	3000 K	Black	257648	135
16 W	30°	On-Off	1550 lm	4000 K	Black	321806	135
16 W	30°	1-10V	1500 lm	3000 K	White	303635	150
16 W	30°	1-10V	1500 lm	3000 K	Black	303628	150
16 W	30°	DALI	1400 lm	2700 K	Black	340241	180
16 W	30°	DALI	1500 lm	3000 K	White	286365	180
16 W	30°	DALI	1500 lm	3000 K	Black	286358	180

LED COB CITIZEN



0,330 Kg
0,0027 m³

POWER	BEAM	CONTROL	LUMEN	CCT	FINISH	CODE	€
24 W	30°	On-Off	2400 lm	3000 K	White	282961	145
24 W	30°	On-Off	2400 lm	3000 K	Black	257662	145
24 W	30°	On-Off	2500 lm	4000 K	Black	321844	145
24 W	30°	1-10V	2400 lm	3000 K	White	303659	155
24 W	30°	1-10V	2400 lm	3000 K	Black	303642	155
24 W	30°	DALI	2400 lm	3000 K	White	286389	185
24 W	30°	DALI	2400 lm	3000 K	Black	286372	185

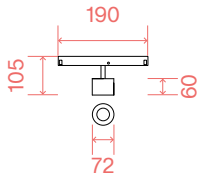
	MODEL	REQUIRED	BEAM	FINISH	CODE	€
LENS	5W	NO	18°	Clear	332062	5
LENS	5W	NO	45°	Clear	332079	5
LENS	16/24W	NO	18°	Clear	332086	5
LENS	16/24W	NO	45°	Clear	332093	5
FILTER HONEYCOMB	5W	NO		Black	260853	5
FILTER HONEYCOMB	16/24W	NO		Black	260860	5

EGO TRACK BIG

SYSTEMS



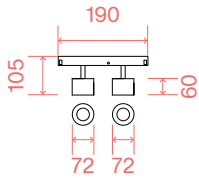
IP20 MacAdam: SDCM 3 UGR: <19 CRI: ≥90 LED LIFE: 50.000 h



LED COB CITIZEN

POWER	BEAM	CONTROL	LUMEN	CCT	FINISH	CODE	€
10 W	38°	On-Off	1000 lm	3000 K	White	327556	110
10 W	38°	On-Off	1000 lm	3000 K	Black	300764	110

0,470 Kg
0,0026 m³



LED COB CITIZEN

POWER	BEAM	CONTROL	LUMEN	CCT	FINISH	CODE	€
20 W	38°	On-Off	2000 lm	3000 K	White	327549	190
20 W	38°	On-Off	2000 lm	3000 K	Black	316307	190

0,750 Kg
0,0026 m³

EGO TRACK FLAT

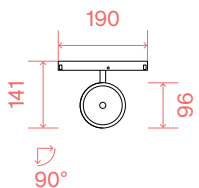
SYSTEMS



IP20 MacAdam: SDCM 3 CRI: ≥90 LED LIFE: 50.000 h



↑ PHOTO p. 296



LED COB CITIZEN

POWER	BEAM	CONTROL	LUMEN	CCT	FINISH	CODE	€
9 W	36°	On-Off	1100 lm	3000 K	White	300504	105
9 W	36°	On-Off	1100 lm	3000 K	Black	290614	105
9 W	36°	1-10V	1100 lm	3000 K	White	303741	120
9 W	36°	1-10V	1100 lm	3000 K	Black	303727	120
9 W	36°	DALI	1100 lm	3000 K	White	300535	150
9 W	36°	DALI	1100 lm	3000 K	Black	300528	150

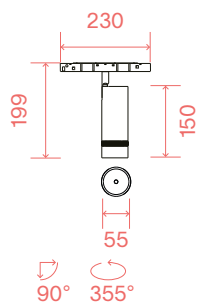
0,480 Kg
0,0030 m³

EGO TRACK ZOOM

SYSTEMS



IP20 MacAdam: SDCM 3 CRI: ≥90 LED LIFE: 50.000 h



LED COB CITIZEN

POWER	BEAM	CONTROL	LUMEN	CCT	FINISH	CODE	€
10 W	20°-40°	On-Off	1000 lm	3000 K	Black	330730	120
10 W	20°-40°	On-Off	1100 lm	4000 K	Black	340197	120
10 W	20°-40°	DALI	1000 lm	3000 K	Black	330754	175
10 W	20°-40°	DALI	1100 lm	4000 K	Black	340180	175

0,500 Kg
0,0035 m³

EGO ACCENT

SYSTEMS

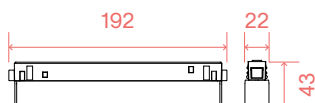


IP20 MacAdam: SDCM 3 UGR: <19 CRI: ≥90 LED LIFE: 50.000 h



↑ PHOTO p. 303

0,140 Kg
0,0013 m³



LED SMD OSRAM

POWER	BEAM	CONTROL	LUMEN	CCT	FINISH	CODE	€
7 W	35°	On-Off	630 lm	2700 K	Black	340067	100
7 W	35°	On-Off	700 lm	3000 K	White	282633	100
7 W	35°	On-Off	700 lm	3000 K	Black	257792	100
7 W	35°	On-Off	730 lm	4000 K	Black	323596	100
7 W	35°	1-10V	700 lm	3000 K	White	303505	135
7 W	35°	1-10V	700 lm	3000 K	Black	303499	135
7 W	35°	DALI	630 lm	2700 K	Black	340043	145
7 W	35°	DALI	700 lm	3000 K	White	286068	145
7 W	35°	DALI	700 lm	3000 K	Black	286051	145

EGO ACCENT

SYSTEMS

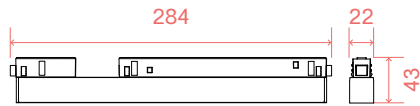


IP20 MacAdam: SDCM 3 UGR: <19 CRI: ≥90 LED LIFE: 50.000 h



↑ PHOTO p. 303

0,330 Kg
0,0010 m³



LED SMD OSRAM

POWER	BEAM	CONTROL	LUMEN	CCT	FINISH	CODE	€
13 W	35°	On-Off	1250 lm	2700 K	Black	340104	140
13 W	35°	On-Off	1400 lm	3000 K	White	282640	140
13 W	35°	On-Off	1400 lm	3000 K	Black	257686	140
13 W	35°	On-Off	1450 lm	4000 K	Black	317953	140
13 W	35°	1-10V	1400 lm	3000 K	White	303529	170
13 W	35°	1-10V	1400 lm	3000 K	Black	303512	170
13 W	35°	DALI	1250 lm	2700 K	Black	340081	200
13 W	35°	DALI	1400 lm	3000 K	White	286082	200
13 W	35°	DALI	1400 lm	3000 K	Black	286075	200

EGO WIDE

SYSTEMS

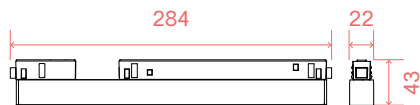


IP20 MacAdam: SDCM 3 CRI: ≥90 LED LIFE: 50.000 h



↑ PHOTO p. 300

0,200 Kg
0,0010 m³



LED SMD SAMSUNG

POWER	BEAM	CONTROL	LUMEN	CCT	FINISH	CODE	€
7 W	110°	On-Off	850 lm	3000 K	White	283029	75
7 W	110°	On-Off	850 lm	3000 K	Black	257709	75
7 W	110°	On-Off	880 lm	4000 K	Black	317960	75
7 W	110°	1-10V	850 lm	3000 K	White	303796	120
7 W	110°	1-10V	850 lm	3000 K	Black	303789	120
7 W	110°	DALI	850 lm	3000 K	White	286501	120
7 W	110°	DALI	850 lm	3000 K	Black	286495	120

EGO WIDE

SYSTEMS



IP20

MacAdam: SDCM 3

CRI: ≥90

LED LIFE: 50.000 h



PHOTO p. 300

0,500 Kg
0,0016 m³



LED SMD SAMSUNG

POWER	BEAM	CONTROL	LUMEN	CCT	FINISH	CODE	€
13 W	110°	On-Off	1450 lm	2700 K	Black	340586	100
13 W	110°	On-Off	1700 lm	3000 K	White	283036	100
13 W	110°	On-Off	1700 lm	3000 K	Black	257716	100
13 W	110°	On-Off	1750 lm	4000 K	Black	322056	100
13 W	110°	1-10V	1700 lm	3000 K	White	303819	130
13 W	110°	1-10V	1700 lm	3000 K	Black	303802	130
13 W	110°	DALI	1450 lm	2700 K	Black	340562	145
13 W	110°	DALI	1700 lm	3000 K	White	286525	145
13 W	110°	DALI	1700 lm	3000 K	Black	286518	145

0,920 Kg
0,0031 m³



LED SMD SAMSUNG

POWER	BEAM	CONTROL	LUMEN	CCT	FINISH	CODE	€
26 W	110°	On-Off	2900 lm	2700 K	Black	340623	145
26 W	110°	On-Off	3400 lm	3000 K	White	283043	145
26 W	110°	On-Off	3400 lm	3000 K	Black	257730	145
26 W	110°	On-Off	3500 lm	4000 K	Black	322070	145
26 W	110°	1-10V	3400 lm	3000 K	White	303833	160
26 W	110°	1-10V	3400 lm	3000 K	Black	303826	160
26 W	110°	DALI	2900 lm	2700 K	Black	340609	185
26 W	110°	DALI	3400 lm	3000 K	White	286549	185
26 W	110°	DALI	3400 lm	3000 K	Black	286532	185

EGO FLEXIBLE ACCENT

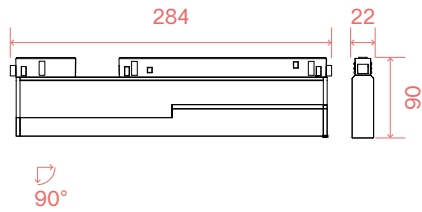
SYSTEMS



IP20 MacAdam: SDCM 3 CRI: ≥90 UGR <19 LED LIFE: 50.000 h



0,470 Kg
0,0031 m³



LED SMD SAMSUNG

POWER	BEAM	CONTROL	LUMEN	CCT	FINISH	CODE	€
13 W	35°	On-Off	1400 lm	3000 K	White	282718	175
13 W	35°	On-Off	1400 lm	3000 K	Black	257846	175
13 W	35°	DALI	1400 lm	3000 K	White	286105	215
13 W	35°	DALI	1400 lm	3000 K	Black	286099	215

EGO FLEXIBLE WIDE

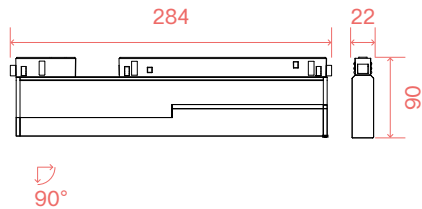
SYSTEMS



IP20 MacAdam: SDCM 3 CRI: ≥90 LED LIFE: 50.000 h



0,620 Kg
0,0016 m³



LED SMD SAMSUNG

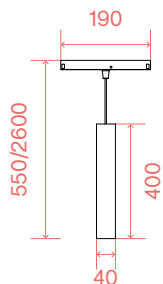
POWER	BEAM	CONTROL	LUMEN	CCT	FINISH	CODE	€
7 W	110°	On-Off	850 lm	3000 K	White	282725	120
7 W	110°	On-Off	850 lm	3000 K	Black	257839	120
7 W	110°	DALI	850 lm	3000 K	White	286129	160
7 W	110°	DALI	850 lm	3000 K	Black	286112	160

EGO PENDANT

SYSTEMS



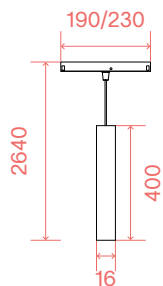
IP20 MacAdam: SDCM 3 UGR: <19 CRI: ≥90 LED LIFE: 50.000 h



0,550 Kg
0,0023 m³

LED COB CITIZEN (UGR <19)

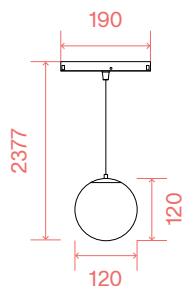
POWER	BEAM	CONTROL	LUMEN	CCT	FINISH	CODE	€
12 W	30°	On-Off	1050 lm	3000 K	White	282879	145
12 W	30°	On-Off	1050 lm	3000 K	Black	257747	145
12 W	30°	On-Off	1150 lm	4000 K	Black	321653	145
12 W	30°	1-10V	1050 lm	3000 K	White	303598	155
12 W	30°	1-10V	1050 lm	3000 K	Black	303574	155
12 W	30°	DALI	1050 lm	3000 K	White	286327	185
12 W	30°	DALI	1050 lm	3000 K	Black	286310	185



0,150 Kg
0,0020 m³

LED COB

POWER	BEAM	CONTROL	LUMEN	CCT	FINISH	CODE	€
5,5 W	66°	On-Off	530 lm	3000 K	Black	332451	90
5,5 W	66°	1-10V	530 lm	3000 K	Black	344782	110
5,5 W	66°	DALI	530 lm	3000 K	Black	344799	140



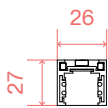
0,900 Kg
0,0125 m³

LED COB CITIZEN

POWER	CONTROL	LUMEN	CCT	FINISH	CODE	€
10 W	On-Off	1050 lm	3000 K	White	327532	130
10 W	On-Off	1050 lm	3000 K	Black	327525	130

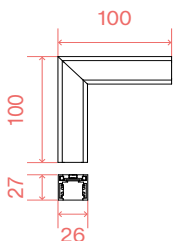
EGO - LOW

SYSTEMS



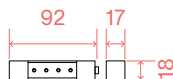
TRACK LOW (NO MOUNTING KIT REQUIRED, DIRECT CEILING INSTALLATION
MAXIMUM LENGTH PER POWER SOURCE: 25 METERS)

LENGTH	WEIGHT	VOLUME	FINISH	CODE	€
1000 mm	0,68 Kg	0,0013 m ³	White	282909	45
1000 mm	0,68 Kg	0,0013 m ³	Black	257877	45
2000 mm	1,36 Kg	0,0026 m ³	White	282916	95
2000 mm	1,36 Kg	0,0026 m ³	Black	266121	95



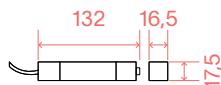
CONNECTOR HORIZONTAL LOW (OPTIONAL)

WEIGHT	VOLUME	CONTROL	FINISH	CODE	€
0,21 Kg	0,0009 m ³	On-Off	White	282848	95
0,21 Kg	0,0009 m ³	On-Off	Black	257990	95
0,21 Kg	0,0009 m ³	1-10V / DALI	White	286266	100
0,21 Kg	0,0009 m ³	1-10V / DALI	Black	286259	100



LINEAR CONNECTOR (REQUIRED - 1 KIT X LINEAR CONNECTION)

WEIGHT	VOLUME	CONTROL	FINISH	CODE	€
0,16 Kg	0,0005 m ³	On-Off	White	285993	40
0,16 Kg	0,0005 m ³	On-Off	Black	283104	40
0,16 Kg	0,0005 m ³	1-10V / DALI	White	285993	40
0,16 Kg	0,0005 m ³	1-10V / DALI	Black	283104	40



MAIN CONNECTOR (REQUIRED - YES - 1 KIT X POWER SOURCE MAX 210 W)

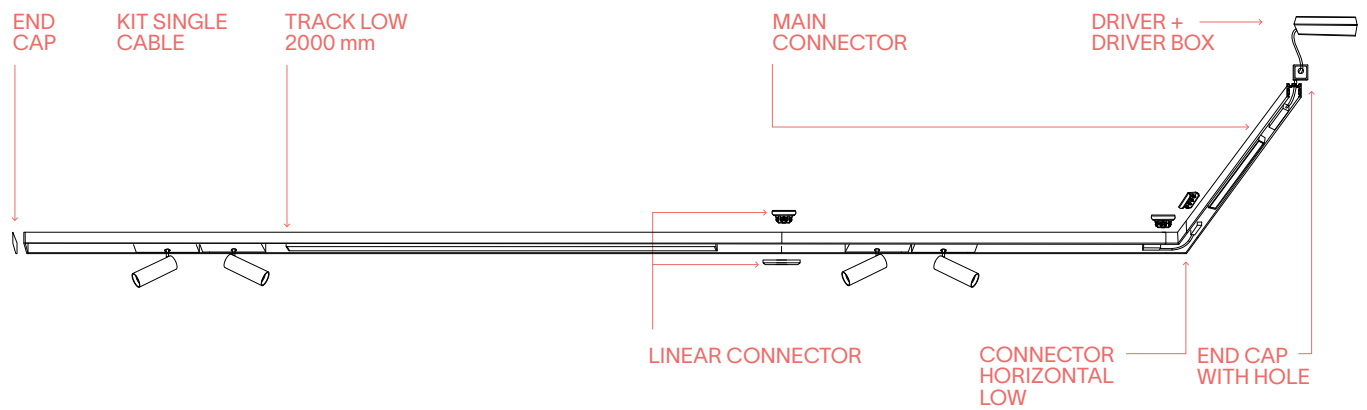
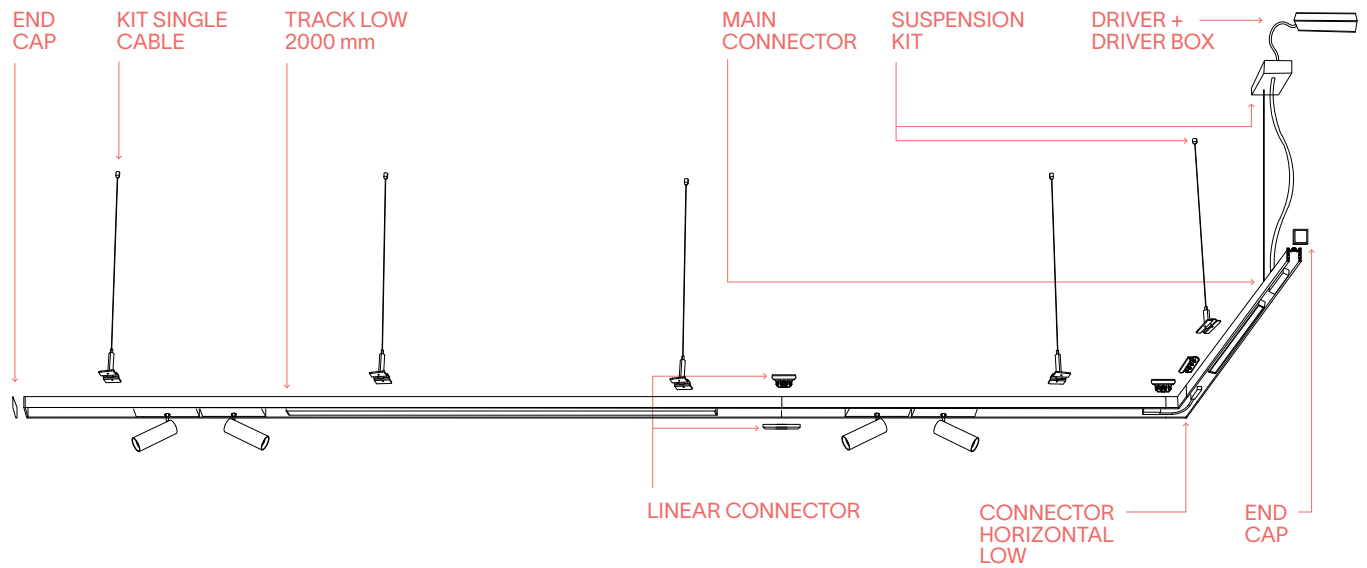
WEIGHT	VOLUME	CONTROL	FINISH	CODE	€
0,12 Kg	0,0007 m ³	On-Off	White	282862	36
0,12 Kg	0,0007 m ³	On-Off	Black	265896	36
0,12 Kg	0,0007 m ³	1-10V / DALI	White	286303	50
0,12 Kg	0,0007 m ³	1-10V / DALI	Black	286297	50

Cable length
2000 mm

	REQUIRED	MEASURE (L X H X W)	FINISH	CODICE	€
END CAP NO HOLE	YES	26 x 11 x 27 mm	White	282688	6
END CAP NO HOLE	YES	26 x 11 x 27 mm	Black	267241	6
END CAP WITH HOLE	YES	26 x 11 x 27 mm	White	282671	6
END CAP WITH HOLE	YES	26 x 11 x 27 mm	Black	267258	6
SUSPENSION KIT	YES - 1 Kit x power source max 210 W	2000 mm	White	282749	55
SUSPENSION KIT		2000 mm	Black	276328	55
KIT SINGLE CABLE	YES - 1 Kit x 900 mm	2000 mm	White	282756	17
KIT SINGLE CABLE		2000 mm	Black	259376	17
BLINDED COVER	NO	1000 x 17 x 18 mm	White	344751	10
BLINDED COVER	NO	1000 x 17 x 18 mm	Black	344768	10

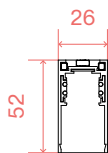
EGO - LOW - ASSEMBLY PLANS

SYSTEMS



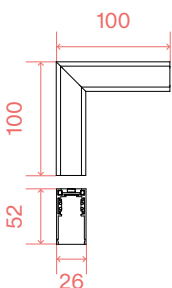
EGO - HIGH

SYSTEMS



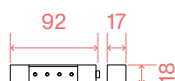
TRACK HIGH (NO MOUNTING KIT REQUIRED, DIRECT CEILING INSTALLATION
MAXIMUM LENGTH PER POWER SOURCE: 25 METERS)

LENGTH	WEIGHT	VOLUME	FINISH	CODE	€
1000 mm	0,90 Kg	0,0023 m ³	White	282886	50
1000 mm	0,90 Kg	0,0023 m ³	Black	258027	50
2000 mm	1,80 Kg	0,0046 m ³	White	282893	120
2000 mm	1,80 Kg	0,0046 m ³	Black	266145	120



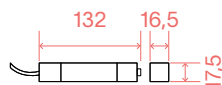
CONNECTOR HORIZONTAL HIGH (OPTIONAL)

WEIGHT	VOLUME	CONTROL	FINISH	CODE	€
0,26 Kg	0,0013 m ³	On-Off	White	282824	90
0,26 Kg	0,0013 m ³	On-Off	Black	258140	90
0,26 Kg	0,0013 m ³	1-10V / DALI	White	286228	100
0,26 Kg	0,0013 m ³	1-10V / DALI	Black	286211	100



LINEAR CONNECTOR (REQUIRED - 1 KIT X LINEAR CONNECTION)

WEIGHT	VOLUME	CONTROL	FINISH	CODE	€
0,16 Kg	0,0005 m ³	On-Off	White	285993	40
0,16 Kg	0,0005 m ³	On-Off	Black	283104	40
0,16 Kg	0,0005 m ³	1-10V / DALI	White	285993	40
0,16 Kg	0,0005 m ³	1-10V / DALI	Black	283104	40



Cable length
2000 mm

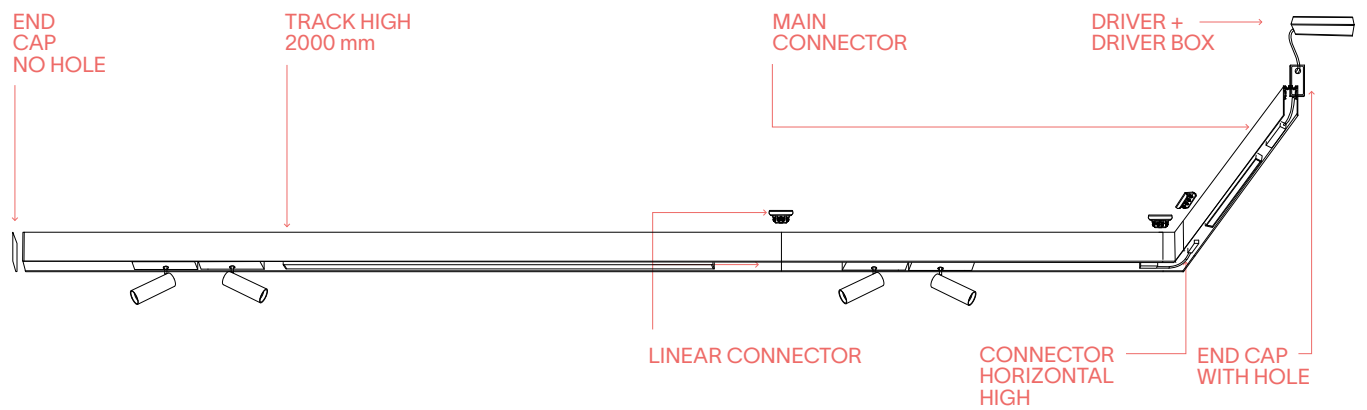
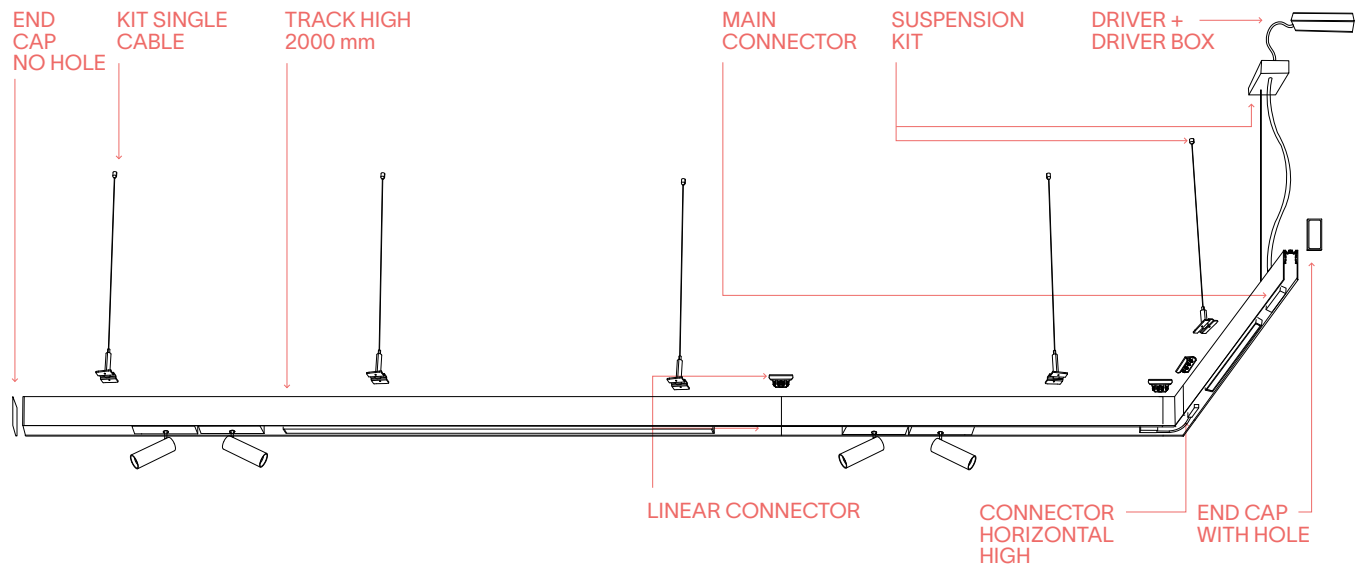
MAIN CONNECTOR (REQUIRED - 1 KIT X POWER SOURCE MAX 210W)

WEIGHT	VOLUME	CONTROL	FINISH	CODE	€
0,12 Kg	0,0007 m ³	On-Off	White	282862	36
0,12 Kg	0,0007 m ³	On-Off	Black	265896	36
0,12 Kg	0,0007 m ³	1-10V / DALI	White	286303	50
0,12 Kg	0,0007 m ³	1-10V / DALI	Black	286297	50

	REQUIRED	MEASURE (L X H X W)	FINISH	CODE	€
END CAP NO HOLE	YES	26 x 11 x 52 mm	White	282664	6
END CAP NO HOLE	YES	26 x 11 x 52 mm	Black	267227	6
END CAP WITH HOLE	YES	26 x 11 x 52 mm	White	282657	6
END CAP WITH HOLE	YES	26 x 11 x 52 mm	Black	267234	6
SUSPENSION KIT	YES - 1 Kit x power source max 210W	2000 mm	White	282749	55
SUSPENSION KIT		2000 mm	Black	276328	55
KIT SINGLE CABLE	YES - 1 Kit x 900 mm	2000 mm	White	282756	17
KIT SINGLE CABLE		2000 mm	Black	259376	17
BLINDED COVER	NO	1000 x 5 x 24 mm	White	282770	17
BLINDED COVER	NO	1000 x 5 x 24 mm	Black	258256	17

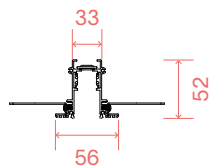
EGO - HIGH - ASSEMBLY PLANS

SYSTEMS



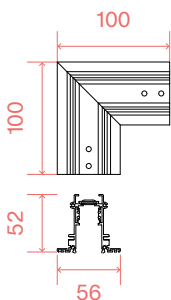
EGO - RECESSED

SYSTEMS



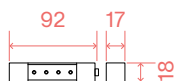
TRACK (KIT FOR ASSEMBLY PROFILE INCLUDED)
MAXIMUM LENGTH PER POWER SOURCE: 25 METERS)

LENGTH	WEIGHT	VOLUME	FINISH	CODE	€
1000 mm	1,52 Kg	0,0039 m ³	White	282923	70
1000 mm	1,52 Kg	0,0039 m ³	Black	258171	70
2000 mm	2,94 Kg	0,0078 m ³	White	282930	150
2000 mm	2,94 Kg	0,0078 m ³	Black	266183	150



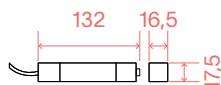
CONNECTOR HORIZONTAL (OPTIONAL)

WEIGHT	VOLUME	CONTROL	FINISH	CODE	€
0,32 Kg	0,0013 m ³	On-Off	White	282787	90
0,32 Kg	0,0013 m ³	On-Off	Black	258232	90
0,32 Kg	0,0013 m ³	1-10V / DALI	White	286204	125
0,32 Kg	0,0013 m ³	1-10V / DALI	Black	286167	125



LINEAR CONNECTOR (REQUIRED - 1 KIT X LINEAR CONNECTION)

WEIGHT	VOLUME	CONTROL	FINISH	CODE	€
0,16 Kg	0,0005 m ³	On-Off	White	283111	40
0,16 Kg	0,0005 m ³	On-Off	Black	286006	40
0,16 Kg	0,0005 m ³	1-10V / DALI	White	283111	40
0,16 Kg	0,0005 m ³	1-10V / DALI	Black	286006	40



MAIN CONNECTOR (REQUIRED - 1 KIT X POWER SOURCE MAX 210W)

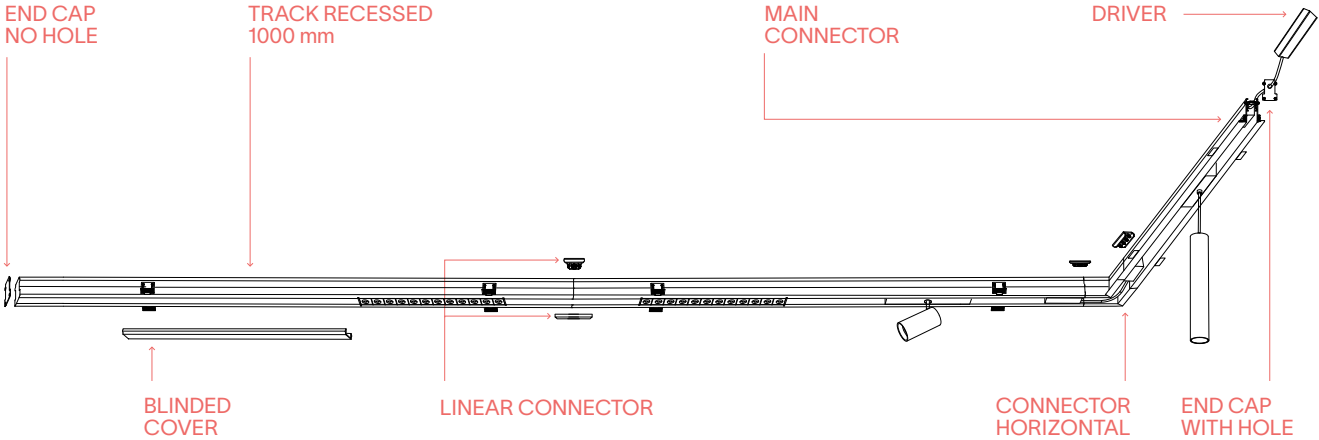
WEIGHT	VOLUME	CONTROL	FINISH	CODE	€
0,12 Kg	0,0007 m ³	On-Off	White	282862	36
0,12 Kg	0,0007 m ³	On-Off	Black	265896	36
0,12 Kg	0,0007 m ³	1-10V / DALI	White	286303	50
0,12 Kg	0,0007 m ³	1-10V / DALI	Black	286297	50

Cable length
2000 mm

	REQUIRED	MEASURE (L X H X W)	FINISH	CODE	€
END CAP NO HOLE	YES	36 x 4 x 52 mm	White	282701	5
END CAP NO HOLE	YES	36 x 4 x 52 mm	Black	267203	5
END CAP WITH HOLE	YES	36 x 4 x 52 mm	White	282695	6
END CAP WITH HOLE	YES	36 x 4 x 52 mm	Black	267210	6
BLINDED COVER	NO	1000 x 5 x 24 mm	White	282770	17
BLINDED COVER	NO	1000 x 5 x 24 mm	Black	258256	17
INSTALLATION TOOL	NO		Black	292922	31

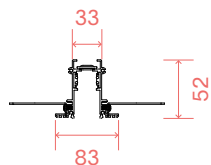
EGO - RECESSED - ASSEMBLY PLANS

SYSTEMS



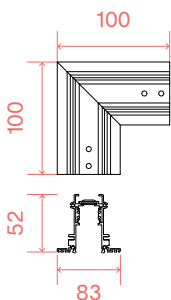
EGO - RECESSED EASY

SYSTEMS



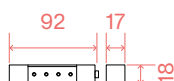
TRACK (NO MOUNTING KIT REQUIRED, DIRECT CEILING INSTALLATION)
MAXIMUM LENGTH PER POWER SOURCE: 25 METERS)

LENGTH	WEIGHT	VOLUME	FINISH	CODE	€
1000 mm	1,16 Kg	0,0058 m ³	White	320489	65
1000 mm	1,16 Kg	0,0058 m ³	Black	320472	65
2000 mm	2,40 Kg	0,0122 m ³	White	320502	130
2000 mm	2,40 Kg	0,0122 m ³	Black	320496	130



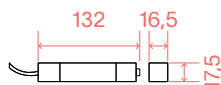
CONNECTOR HORIZONTAL (OPTIONAL)

WEIGHT	VOLUME	CONTROL	FINISH	CODE	€
0,30 Kg	0,0010 m ³	On-Off	White	320748	115
0,30 Kg	0,0010 m ³	On-Off	Black	320731	115
0,30 Kg	0,0010 m ³	1-10V / DALI	White	320724	135
0,30 Kg	0,0010 m ³	1-10V / DALI	Black	320717	135



LINEAR CONNECTOR (REQUIRED - 1 KIT X LINEAR CONNECTION)

WEIGHT	VOLUME	CONTROL	FINISH	CODE	€
0,16 Kg	0,0005 m ³	On-Off	White	283111	40
0,16 Kg	0,0005 m ³	On-Off	Black	286006	40
0,16 Kg	0,0005 m ³	1-10V / DALI	White	283111	40
0,16 Kg	0,0005 m ³	1-10V / DALI	Black	286006	40



MAIN CONNECTOR (REQUIRED - 1 KIT X POWER SOURCE MAX 210W)

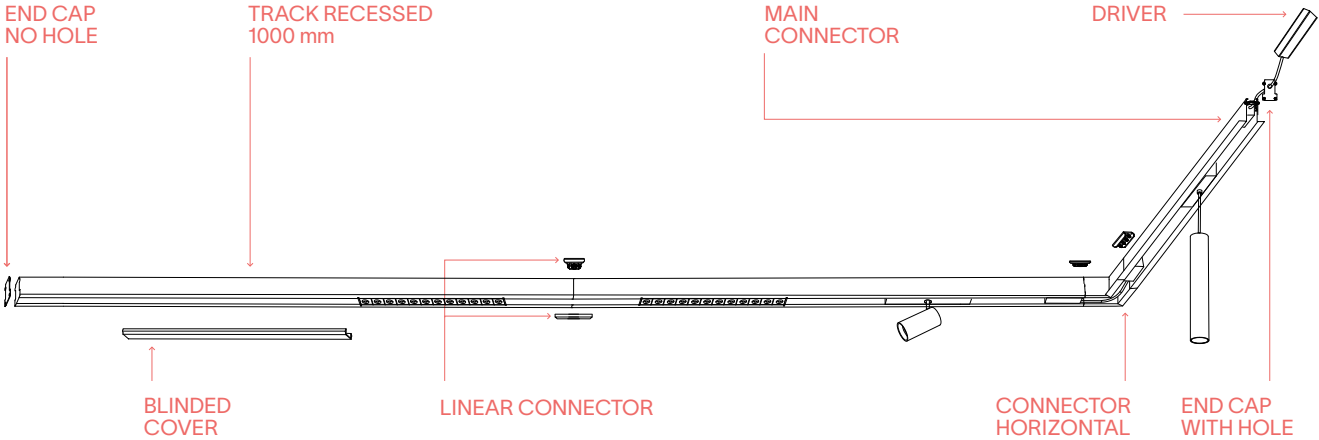
WEIGHT	VOLUME	CONTROL	FINISH	CODE	€
0,12 Kg	0,0007 m ³	On-Off	White	282862	36
0,12 Kg	0,0007 m ³	On-Off	Black	265896	36
0,12 Kg	0,0007 m ³	1-10V / DALI	White	286303	50
0,12 Kg	0,0007 m ³	1-10V / DALI	Black	286297	50

Cable length
2000 mm

	REQUIRED	MEASURE (L X H X W)	FINISH	CODE	€
END CAP NO HOLE	YES	83 x 52 x 30 mm	White	320564	6
END CAP NO HOLE	YES	83 x 52 x 30 mm	Black	320557	6
END CAP WITH HOLE	YES	83 x 52 x 30 mm	White	320588	6
END CAP WITH HOLE	YES	83 x 52 x 30 mm	Black	320571	6
BLINDED COVER	NO	1000 x 5 x 24 mm	White	282770	17
BLINDED COVER	NO	1000 x 5 x 24 mm	Black	258256	17

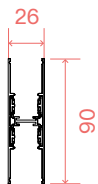
EGO - RECESSED EASY - ASSEMBLY PLANS

SYSTEMS



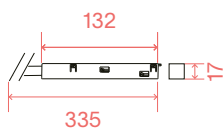
EGO - BI-EMISSION

SYSTEMS



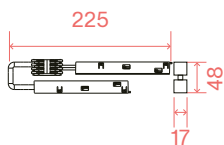
TRACK BI-EMISSION (MAXIMUM LENGTH PER POWER SOURCE: 13 METERS)

LENGTH	WEIGHT	VOLUME	FINISH	CODE	€
1000 mm	1,40kg	0,0058 m ³	Black	322513	145
2000 mm	2,90 Kg	0,0080 m ³	Black	340647	290



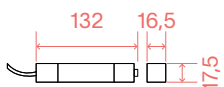
BI-EMISSION LINEAR CONNECTOR (REQUIRED - 1 KIT X LINEAR CONNECTION)

WEIGHT	VOLUME	CONTROL	FINISH	CODE	€
0,271 Kg	0,0032 m ³	On-Off	Black	339863	215
0,271 Kg	0,0032 m ³	1-10V / DALI	Black	351346	240



BI-EMISSION UP/DOWN ELECTRICAL CONNECTOR (REQUIRED - 1 KIT X LINEAR CONNECTION)

WEIGHT	VOLUME	CONTROL	FINISH	CODE	€
0,100 Kg	0,0016 m ³	On-Off	Black	322810	70
0,100 Kg	0,0016 m ³	1-10V / DALI	Black	342757	80



MAIN CONNECTOR (REQUIRED - 1 KIT X POWER SOURCE MAX 210W)

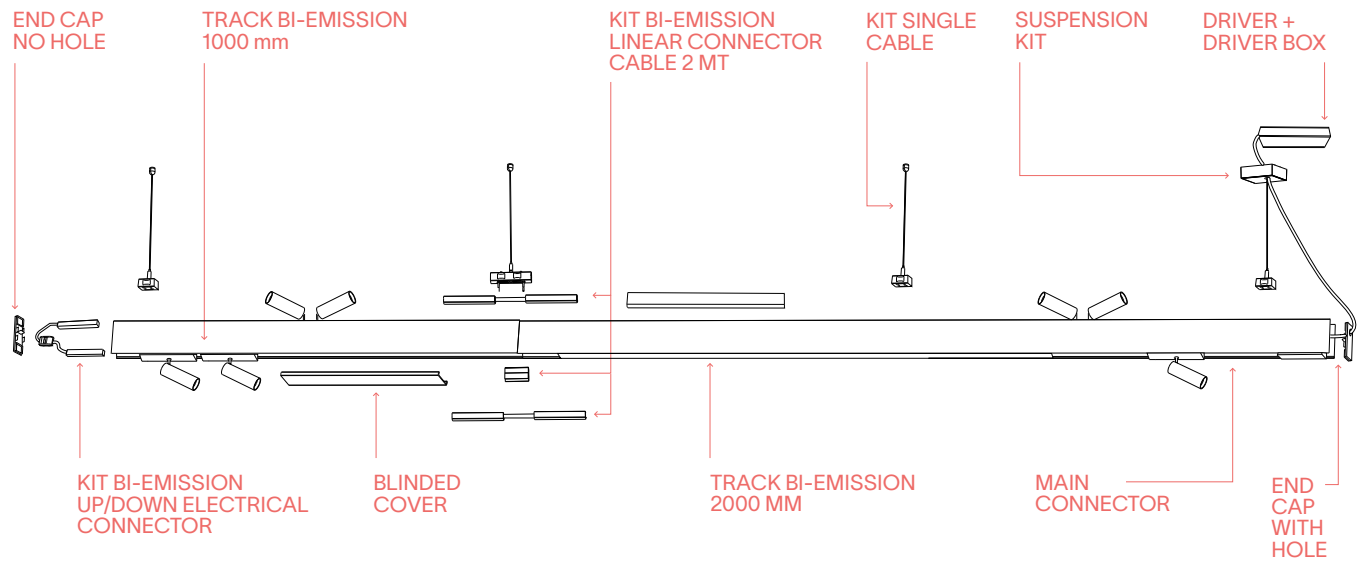
WEIGHT	VOLUME	CONTROL	FINISH	CODE	€
0,12 Kg	0,0005 m ³	On-Off	White	282862	36
0,12 Kg	0,0005 m ³	On-Off	Black	265896	36
0,12 Kg	0,0005 m ³	1-10V / DALI	White	286303	50
0,12 Kg	0,0005 m ³	1-10V / DALI	Black	286297	50

Cable lenght
2000 mm

	REQUIRED	MEASURE (L X H X W)	FINISH	CODE	€
END CAP NO HOLE	YES	26 x 90 x 2 mm	White	322841	6
END CAP WITH HOLE	YES	26 x 90 x 2 mm	Black	322858	6
SUSPENSION KIT	YES - 1 Kit x power source max 210W	2100 mm	White	322476	55
KIT SINGLE CABLE	YES - 1 Kit x 900 mm	2085 mm	White	322490	35
BLINDED COVER	NO	1000 x 5 x 24 mm	Black	258256	17

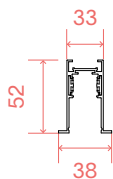
EGO - BI-EMISSION - ASSEMBLY PLANS

SYSTEMS



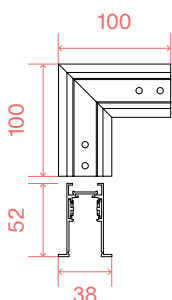
EGO - RECESSED TRIM

SYSTEMS



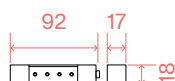
TRACK (KIT FOR ASSEMBLY PROFILE INCLUDED)
MAXIMUM LENGHT PER POWER SOURCE: 25 METERS)

LENGTH	WEIGHT	VOLUME	FINISH	CODE	€
1000 mm	1,13 Kg	0,0058 m ³	White	320441	85
1000 mm	1,13 Kg	0,0058 m ³	Black	320434	85
2000 mm	2,25 Kg	0,0122 m ³	White	320465	170
2000 mm	2,25 Kg	0,0122 m ³	Black	320458	170



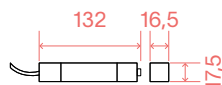
CONNECTOR HORIZONTAL (OPTIONAL)

WEIGHT	VOLUME	CONTROL	FINISH	CODE	€
0,30 Kg	0,0010 m ³	On-Off	White	320625	125
0,30 Kg	0,0010 m ³	On-Off	Black	320618	125
0,30 Kg	0,0010 m ³	1-10V / DALI	White	320601	145
0,30 Kg	0,0010 m ³	1-10V / DALI	Black	320595	145



LINEAR CONNECTOR (REQUIRED - 1 KIT X LINEAR CONNECTION)

WEIGHT	VOLUME	CONTROL	FINISH	CODE	€
0,16 Kg	0,0005 m ³	On-Off	White	283111	40
0,16 Kg	0,0005 m ³	On-Off	Black	286006	40
0,16 Kg	0,0005 m ³	1-10V / DALI	White	283111	40
0,16 Kg	0,0005 m ³	1-10V / DALI	Black	286006	40



MAIN CONNECTOR (REQUIRED - 1 KIT X POWER SOURCE MAX 210W)

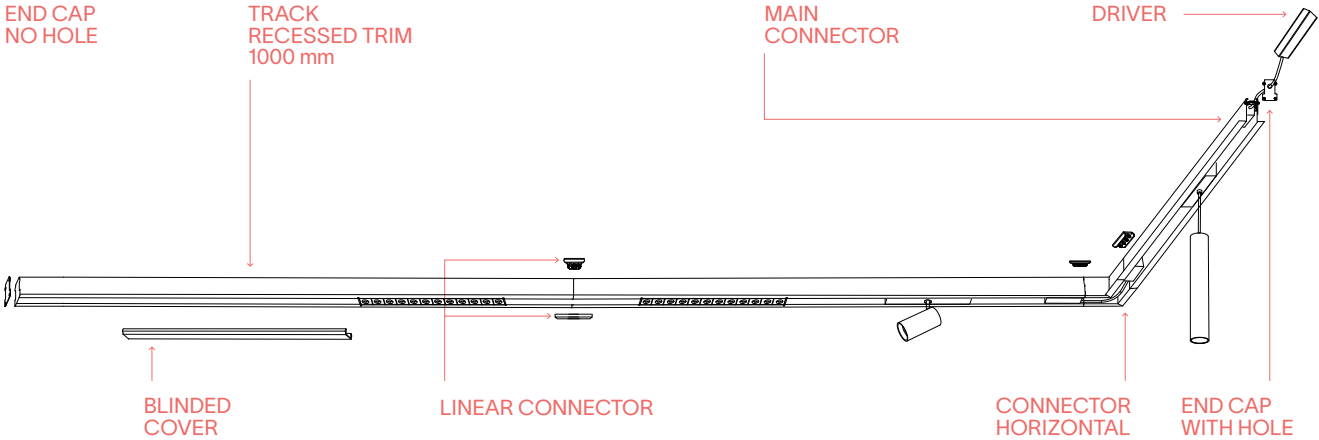
WEIGHT	VOLUME	CONTROL	FINISH	CODE	€
0,12 Kg	0,0007 m ³	On-Off	White	282862	36
0,12 Kg	0,0007 m ³	On-Off	Black	265896	36
0,12 Kg	0,0007 m ³	1-10V / DALI	White	286303	50
0,12 Kg	0,0007 m ³	1-10V / DALI	Black	286297	50

Cable length
2000 mm

	REQUIRED	MEASURE (L X H X W)	FINISH	CODE	€
END CAP NO HOLE	YES	38 x 52 x 17 mm	White	320526	6
END CAP NO HOLE	YES	38 x 52 x 17 mm	Black	320519	6
END CAP WITH HOLE	YES	38 x 52 x 17 mm	White	320540	9
END CAP WITH HOLE	YES	38 x 52 x 17 mm	Black	320533	9
BLINDED COVER	NO	1000 x 5 x 24 mm	White	282770	17
BLINDED COVER	NO	1000 x 5 x 24 mm	Black	258256	17

EGO - RECESSED TRIM - ASSEMBLY PLANS

SYSTEMS



EGO - DRIVERS

SYSTEMS

DRIVER MEANWELL ON/OFF (REQUIRED)



POWER	OUTPUT	MEASURE (L X H X W)	DRIVER BOX	CODE	€
75 W	48 Vdc	171x37x62 mm	255x55x75 mm	223155	140
96 W	48 Vdc	220x37x68 mm	330x60x80 mm	223162	185
150 W	48 Vdc	228x37x68 mm	330x60x80 mm	223179	205
240 W	48 Vdc	244x39x68 mm	330x60x80 mm	224275	230

DRIVER BOX (OPTIONAL)

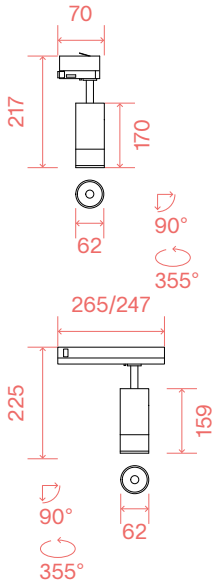
MATERIAL	MEASURE	FINISH	CODE	€
Metal	255x55x75 mm	White	302379	25
Metal	255x55x75 mm	Black	302362	25
Metal	330x60x80 mm	White	302355	30
Metal	330x60x80 mm	Black	302348	30

MAGNETIC DRIVER (REQUIRED - CABLE LENGTH 2000 MM IT REPLACES DRIVER + MAIN CONNECTOR*)

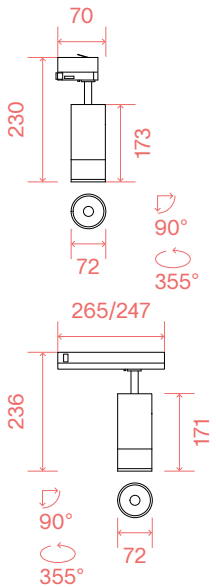


POWER	OUTPUT	MEASURE (L X H X W)	CODE	€
100 W	48 Vdc	297x20x16 mm	296302	90
150 W	48 Vdc	268x43x16 mm	325750	95
250 W	48 Vdc	268x43x16 mm	325767	110

*Codes 325750 and 325767 suggested use with HIGH and RECESSED versions.



0,710 Kg
0,0026 m³



1,100 Kg
0,0033 m³

LED COB BRIDGELUX (DRIVER INCLUDED)

POWER	BEAM	CONTROL	LUMEN	CCT	TRACK	FINISH	CODE	€
15 W	20-55°	On-Off	1400 lm	2700 K	3-Phase	White	340807	73
15 W	20-55°	On-Off	1400 lm	2700 K	3-Phase	Black	340791	73
15 W	20-55°	On-Off	1450 lm	3000 K	3-Phase	White	286594	73
15 W	20-55°	On-Off	1450 lm	3000 K	3-Phase	Black	276182	73
15 W	20-55°	On-Off	1650 lm	4000 K	3-Phase	White	322094	73
15 W	20-55°	On-Off	1650 lm	4000 K	3-Phase	Black	322087	73
15 W	20-55°	1-10V	1450 lm	3000 K	3-Phase	White	302959	116
15 W	20-55°	1-10V	1450 lm	3000 K	3-Phase	Black	302942	116
15 W	20-55°	DALI	1450 lm	3000 K	3-Phase	White	302997	135
15 W	20-55°	DALI	1450 lm	3000 K	3-Phase	Black	302980	135
15 W	20-55°	On-Off	1450 lm	3000 K	1-Phase	Black	337579	65

LED COB BRIDGELUX (DRIVER INCLUDED)

POWER	BEAM	CONTROL	LUMEN	CCT	TRACK	FINISH	CODE	€
25 W	20-55°	On-Off	2450 lm	2700 K	3-Phase	White	340821	92
25 W	20-55°	On-Off	2450 lm	2700 K	3-Phase	Black	340814	92
25 W	20-55°	On-Off	2500 lm	3000 K	3-Phase	White	286600	92
25 W	20-55°	On-Off	2500 lm	3000 K	3-Phase	Black	276243	92
25 W	20-55°	On-Off	2650 lm	4000 K	3-Phase	White	322124	92
25 W	20-55°	On-Off	2650 lm	4000 K	3-Phase	Black	322100	92
25 W	20-55°	1-10V	2500 lm	3000 K	3-Phase	White	302973	135
25 W	20-55°	1-10V	2500 lm	3000 K	3-Phase	Black	302966	135
25 W	20-55°	DALI	2500 lm	3000 K	3-Phase	White	303017	155
25 W	20-55°	DALI	2500 lm	3000 K	3-Phase	Black	303000	155
25 W	20-55°	On-Off	2500 lm	3000 K	1-Phase	Black	342740	85

	REQUIRED	DRIVER	FINISH	CODE	€
LINK SINGLE CONNECTION	NO	On/Off	White	170145	27
LINK SINGLE CONNECTION	NO	On/Off	Black	170152	27

FLUO WIDE

SYSTEMS



IP20

MacAdam: SDCM 3

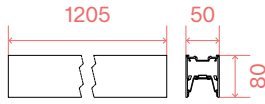
CRI: ≥90

LED LIFE: 50.000 h



PHOTO p. 314

2,890 Kg
0,0183 m³
Cable length
2150 mm



LED SMD SAMSUNG (DRIVER TRIDONIC ON/OFF INCLUDED)

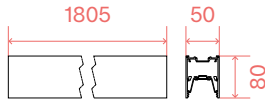
POWER	BEAM	LUMEN	CCT	FINISH	CODE	€
27 W	105°	3350 lm	3000 K	White	192437	330
27 W	105°	3350 lm	3000 K	Black	191997	330
27 W	105°	3600 lm	4000 K	White	192482	330
27 W	105°	3600 lm	4000 K	Black	192505	330

DIMMABLE DRIVER* (NOT INCLUDED/OPTIONAL)

	POWER	OUTPUT	MEASURE	CODE	€
1-10V	28 W	500 mA	280 x 21 x 30 mm	216423	145
DALI/Push	27 W	500 mA	280 x 21 x 30 mm	216287	160

*The dimmable power supplies must be ordered in concomitance with the product and will be included inside the fittings by replacing the on-off power supply. The linear connection is available only for the on-off versions of the products.

4,420 Kg
0,0257 m³
Cable length
2150 mm



LED SMD SAMSUNG (DRIVER TRIDONIC ON/OFF INCLUDED)

POWER	BEAM	LUMEN	CCT	FINISH	CODE	€
36 W	105°	4600 lm	3000 K	White	192550	425
36 W	105°	4600 lm	3000 K	Black	192567	425
36 W	105°	4750 lm	4000 K	White	192604	425
36 W	105°	4750 lm	4000 K	Black	192628	425

DIMMABLE DRIVER* (NOT INCLUDED/OPTIONAL)

	POWER	OUTPUT	MEASURE	CODE	€
1-10V	39 W	700 mA	280 x 21 x 30 mm	216416	145
DALI/Push	38 W	700 mA	280 x 21 x 30 mm	216270	160

*The dimmable power supplies must be ordered in concomitance with the product and will be included inside the fittings by replacing the on-off power supply. The linear connection is available only for the on-off versions of the products.

FLUO BI-EMISSION*

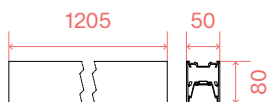
SYSTEMS



IP20 MacAdam: SDCM 3 CRI: ≥90 LED LIFE: 50.000 h



2,890 Kg
0,0183 m³
Cable length
2150 mm



LED SMD SAMSUNG (UP-LIGHT INCLUDED - DRIVER TRIDONIC ON/OFF INCLUDED)

POWER	BEAM	LUMEN	CCT	FINISH	CODE	€
40 W	105°	3300 lm	3000 K	White	192666	425
40 W	105°	3300 lm	3000 K	Black	192710	425
40 W	105°	3550 lm	4000 K	White	192741	425
40 W	105°	3550 lm	4000 K	Black	192758	425

UP-LIGHT INFO

KIT DIMMABLE DRIVER*

POWER	BEAM	LUMEN	CCT		CODE	€
13 W	105°	1800 lm	3000 K	1-10V	270692	230
13 W	105°	1900 lm	4000 K	DALI/Push	270876	260

*Separate switching on of direct and indirect output (available only for on-off versions). Control of the direct and indirect output in synchrony (versions with 1-10V and Push dimming). The dimmable power supplies must be ordered in concomitance with the product and will be included inside the fittings by replacing the on-off power supply. The linear connection is available only for the on-off versions of the products.

4,420 Kg
0,0269 m³
Cable length
2150 mm



LED SMD SAMSUNG (UP-LIGHT INCLUDED - DRIVER TRIDONIC ON/OFF INCLUDED)

POWER	BEAM	LUMEN	CCT	FINISH	CODE	€
54 W	105°	4800 lm	3000 K	White	192703	580
54 W	105°	4800 lm	3000 K	Black	192697	580
54 W	105°	4950 lm	4000 K	White	192673	580
54 W	105°	4950 lm	4000 K	Black	192642	580

UP-LIGHT INFO

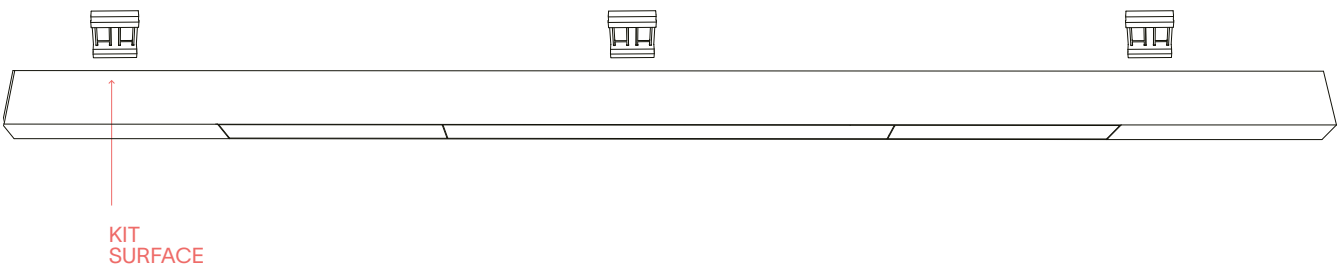
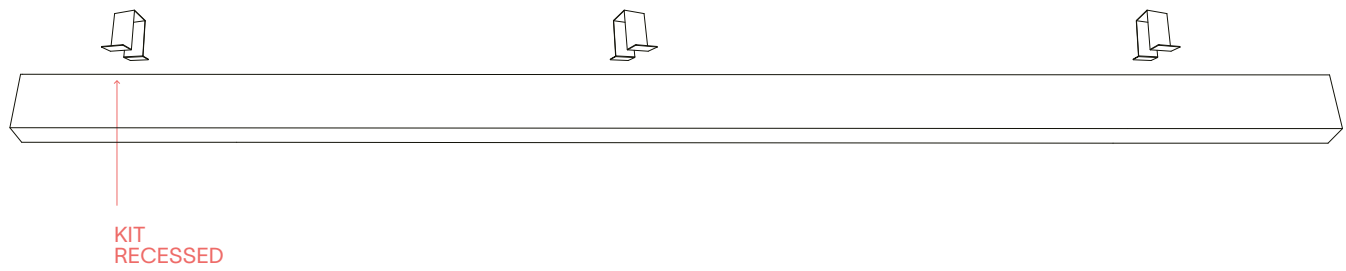
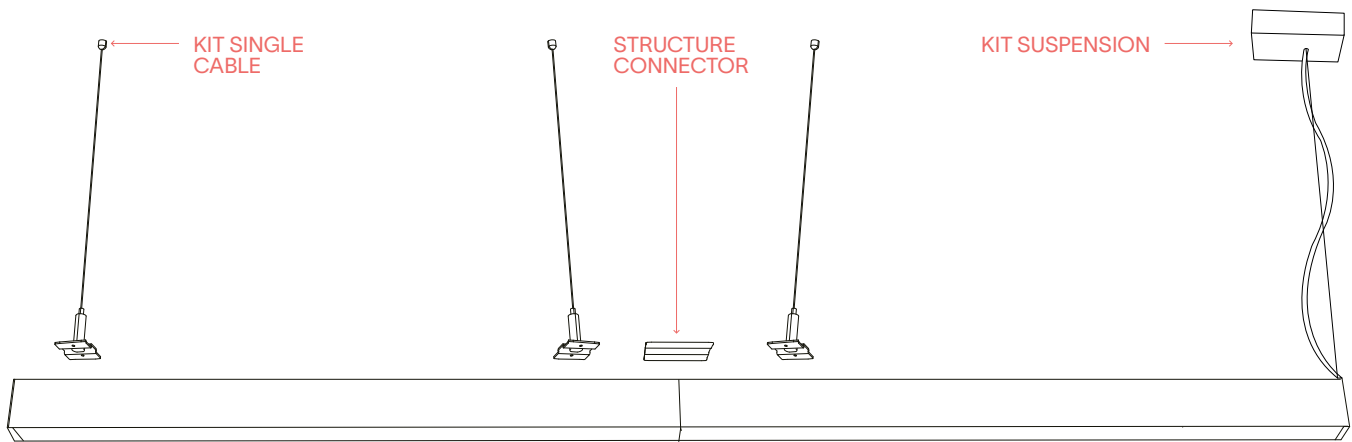
KIT DIMMABLE DRIVER*

POWER	BEAM	LUMEN	CCT		CODE	€
18 W	105°	2400 lm	3000 K	1-10V	270883	230
18 W	105°	2550 lm	4000 K	DALI/Push	270937	260

*Separate switching on of direct and indirect output (available only for on-off versions). Control of the direct and indirect output in synchrony (versions with 1-10V and Push dimming). The dimmable power supplies must be ordered in concomitance with the product and will be included inside the fittings by replacing the on-off power supply. The linear connection is available only for the on-off versions of the products.

FLUO - ASSEMBLY PLANS

SYSTEMS



FLUO - MOUNTING KIT

SYSTEMS

	REQUIRED	N' CABLES	CABLES LENGTH	FINISH	CODE	€
KIT SUSPENSION		1	2000 mm	White	277929	32
KIT SUSPENSION	YES	1	2000 mm	Black	277912	32
KIT SUSPENSION	1 Kit x power source	1	5000 mm	White	276342	43
KIT SUSPENSION		1	5000 mm	Black	276335	43
KIT SINGLE CABLE	YES - 1 Kit x 600 mm	1	2000 mm		220826	13
KIT SINGLE CABLE	YES - 1 Kit x 600 mm	1	5000 mm		243665	20
KIT RECESSED	YES - 1 Kit x 600 mm	1			191188	25
KIT SURFACE	YES - 1 Kit x 600 mm	1			191171	25

FLUO - OPTIONAL

SYSTEMS

0,140 Kg
0,0001 m³


STRUCTURE CONNECTOR
(MAXIMUM LENGHT PER POWER SOURCE:
30 METERS)

REQUIRED	CODE	€
YES - 1 Kit x connection	191508	12

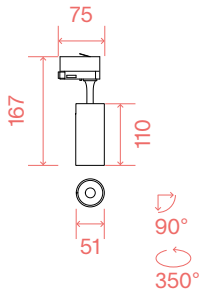
FOX 8W

 **ON-OFF**
 **1-10V/DALI**

PROJECTORS

IP20 MacAdam: SDCM 3 CRI: $\geq 80 / \geq 90$ LED LIFE: 50.000 h  **PHOTO** p. 320

ON/OFF

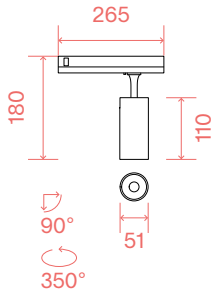


LED COB BRIDGELUX (DRIVER INCLUDED)

CRI ≥ 80

POWER	BEAM	CONTROL	LUMEN	CCT	TRACK	FINISH	CODE	€
8 W	41°	On-Off	1050 lm	3000 K	3-Phase	White	250410	45
8 W	41°	On-Off	1050 lm	3000 K	3-Phase	Black	250403	45
8 W	41°	On-Off	1050 lm	3000 K	3-Phase	Brass	283920	49
8 W	41°	On-Off	1100 lm	4000 K	3-Phase	White	271453	45
8 W	41°	On-Off	1100 lm	4000 K	3-Phase	Black	271446	45

1-10V



CRI ≥ 90

POWER	BEAM	CONTROL	LUMEN	CCT	TRACK	FINISH	CODE	€
8 W	41°	On-Off	800 lm	2700 K	3-Phase	White	340845	45
8 W	41°	On-Off	800 lm	2700 K	3-Phase	Black	340838	45
8 W	41°	On-Off	950 lm	3000 K	3-Phase	White	285368	45
8 W	41°	On-Off	950 lm	3000 K	3-Phase	Black	285351	45
8 W	41°	On-Off	1000 lm	4000 K	3-Phase	White	322339	45
8 W	41°	On-Off	1000 lm	4000 K	3-Phase	Black	322322	45
8 W	41°	1-10V	900 lm	3000 K	3-Phase	White	302546	85
8 W	41°	1-10V	900 lm	3000 K	3-Phase	Black	302539	85
8 W	41°	1-10V	1050 lm	4000 K	3-Phase	White	340869	85
8 W	41°	1-10V	1050 lm	4000 K	3-Phase	Black	340852	85
8 W	41°	On-Off	950 lm	3000 K	1-Phase	Black	348308	35

0,460 Kg
0,0029 m³

	MODEL	REQUIRED	BEAM	DRIVER	FINISH	CODE	€
LENS	1-10V / DALI	NO	23°		Clear	302744	5
LENS	On/Off	NO	23°		Clear	349121	5
LINK SINGLE CONNECTION		NO		On/Off	White	170145	23
LINK SINGLE CONNECTION		NO		On/Off	Black	170152	23

FOX 15W

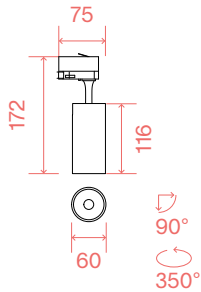
 **ON-OFF**
 **1-10V/DALI**

PROJECTORS

IP20 MacAdam: SDCM 3 CRI: $\geq 80 / \geq 90$ LED LIFE: 50.000 h

ON/OFF

LED COB BRIDGELUX (DRIVER INCLUDED)

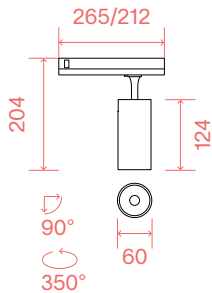


CRI ≥ 80

POWER	BEAM	CONTROL	LUMEN	CCT	TRACK	FINISH	CODE	€
15 W	41°	On-Off	1850 lm	3000 K	3-Phase	White	250434	50
15 W	41°	On-Off	1850 lm	3000 K	3-Phase	Black	250427	50
15 W	41°	On-Off	1700 lm	3000 K	3-Phase	Brass	283937	55
15 W	41°	On-Off	1900 lm	4000 K	3-Phase	White	267784	50
15 W	41°	On-Off	1900 lm	4000 K	3-Phase	Black	267777	50

1-10V/DALI

CRI ≥ 90



POWER	BEAM	CONTROL	LUMEN	CCT	TRACK	FINISH	CODE	€
15 W	41°	On-Off	1450 lm	2700 K	3-Phase	White	340883	50
15 W	41°	On-Off	1450 lm	2700 K	3-Phase	Black	340876	50
15 W	41°	On-Off	1600 lm	3000 K	3-Phase	White	285382	50
15 W	41°	On-Off	1600 lm	3000 K	3-Phase	Black	285375	50
15 W	41°	On-Off	1750 lm	4000 K	3-Phase	White	322360	50
15 W	41°	On-Off	1750 lm	4000 K	3-Phase	Black	322346	50
15 W	41°	1-10V	1600 lm	3000 K	3-Phase	White	302560	80
15 W	41°	1-10V	1600 lm	3000 K	3-Phase	Black	302553	80
15 W	41°	1-10V	1750 lm	4000 K	3-Phase	White	340906	80
15 W	41°	1-10V	1750 lm	4000 K	3-Phase	Black	340890	80
15 W	41°	DALI	1600 lm	3000 K	3-Phase	White	302584	110
15 W	41°	DALI	1600 lm	3000 K	3-Phase	Black	302577	110
15 W	41°	DALI	1750 lm	4000 K	3-Phase	White	340920	110
15 W	41°	DALI	1750 lm	4000 K	3-Phase	Black	340913	110
15 W	41°	On-Off	1600 lm	3000 K	1-Phase	Black	348315	40

0,600 Kg
0,0037 m³

	MODEL	REQUIRED	BEAM	DRIVER	FINISH	CODE	€
LENS	1-10V / DALI	NO	15°		Clear	302751	5
LENS	On/Off	NO	15°		Clear	349138	5
LINK SINGLE CONNECTION		NO		On/Off	White	170145	23
LINK SINGLE CONNECTION		NO		On/Off	Black	170152	23

FOX 25W

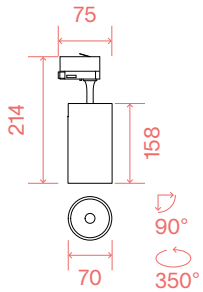
 **ON-OFF**
 **1-10V/DALI**

PROJECTORS

IP20 MacAdam: SDCM 3 CRI: $\geq 80 / \geq 90$ LED LIFE: 50.000 h

ON/OFF

LED COB BRIDGELUX (DRIVER INCLUDED)

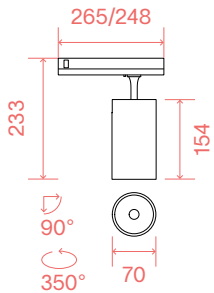


CRI ≥ 80

POWER	BEAM	CONTROL	LUMEN	CCT	TRACK	FINISH	CODE	€
25 W	35°	On-Off	2900 lm	3000 K	3-Phase	White	250458	55
25 W	35°	On-Off	2900 lm	3000 K	3-Phase	Black	250441	55
25 W	35°	On-Off	2950 lm	3000 K	3-Phase	Brass	283944	60
25 W	35°	On-Off	3050 lm	4000 K	3-Phase	White	267807	55
25 W	35°	On-Off	3050 lm	4000 K	3-Phase	Black	267791	55

1-10V/DALI

CRI ≥ 90



POWER	BEAM	CONTROL	LUMEN	CCT	TRACK	FINISH	CODE	€
25 W	35°	On-Off	2800 lm	2700 K	3-Phase	White	340944	55
25 W	35°	On-Off	2800 lm	2700 K	3-Phase	Black	340937	55
25 W	35°	On-Off	2950 lm	3000 K	3-Phase	White	285405	55
25 W	35°	On-Off	2950 lm	3000 K	3-Phase	Black	285399	55
25 W	35°	On-Off	3000 lm	4000 K	3-Phase	White	322391	55
25 W	35°	On-Off	3000 lm	4000 K	3-Phase	Black	322377	55
25 W	35°	1-10V	2900 lm	3000 K	3-Phase	White	302607	100
25 W	35°	1-10V	2900 lm	3000 K	3-Phase	Black	302591	100
25 W	35°	1-10V	3000 lm	4000 K	3-Phase	White	340968	100
25 W	35°	1-10V	3000 lm	4000 K	3-Phase	Black	340951	100
25 W	35°	DALI	2900 lm	3000 K	3-Phase	White	302621	115
25 W	35°	DALI	2900 lm	3000 K	3-Phase	Black	302614	115
25 W	35°	DALI	3000 lm	4000 K	3-Phase	White	340982	115
25 W	35°	DALI	3000 lm	4000 K	3-Phase	Black	340975	115
25 W	35°	On-Off	2950 lm	3000 K	1-Phase	Black	348322	45

0,780 Kg
0,0042 m³

	MODEL	REQUIRED	BEAM	DRIVER	FINISH	CODE	€
LENS	1-10V / DALI	NO	15°		Clear	302768	5
LENS	On/Off	NO	15°		Clear	349145	5
LINK SINGLE CONNECTION		NO		On/Off	White	170145	23
LINK SINGLE CONNECTION		NO		On/Off	Black	170152	23

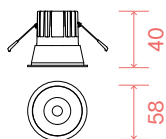
GAME TRIM ROUND

RECESSED LIGHTS



IP20 / 65 UGR:<19 CRI: ≥90 LED LIFE: 50.000 h

↑ PHOTO p. 342

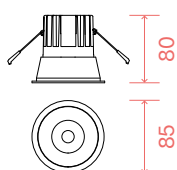


75

0,200 Kg
0,0009 m³

LED COB CREE (DRIVER ON/OFF INCLUDED)

POWER	BEAM	LUMEN	CCT	ESTERNO	FINISH	CODE	€
5,5 W	36°	650 lm	3000 K	White	White	337142	35
5,5 W	36°	650 lm	3000 K	White	Gold	349084	35
5,5 W	36°	650 lm	3000 K	Black	Black	349060	35
5,5 W	36°	650 lm	3000 K	Black	Gold	349077	35



75

0,350 Kg
0,0016 m³

LED COB CREE (DRIVER ON/OFF INCLUDED)

POWER	BEAM	LUMEN	CCT	FRAME	FINISH	CODE	€
11 W	36°	900 lm	2700 K	White	White	285429	45
11 W	36°	900 lm	2700 K	White	Gold	341347	45
11 W	36°	950 lm	3000 K	White	Silver	192284	45
11 W	36°	950 lm	3000 K	White	White	192291	45
11 W	36°	950 lm	3000 K	White	Black	192277	45
11 W	36°	950 lm	3000 K	White	Gold	192307	45
11 W	36°	1100 lm	4000 K	White	White	267975	45
11 W	36°	1100 lm	4000 K	White	Gold	341361	45
11 W	36°	900 lm	2700 K	Black	Black	285412	45
11 W	36°	900 lm	2700 K	Black	Gold	341330	45
11 W	36°	950 lm	3000 K	Black	Silver	192321	45
11 W	36°	950 lm	3000 K	Black	White	192338	45
11 W	36°	950 lm	3000 K	Black	Black	192314	45
11 W	36°	950 lm	3000 K	Black	Gold	192345	45
11 W	36°	1100 lm	4000 K	Black	Black	267968	45
11 W	36°	1100 lm	4000 K	Black	Gold	341354	45

IP65

POWER	BEAM	LUMEN	CCT	FRAME	FINISH	CODE	€
11 W	36°	950 lm	3000 K	Black	White	313191	75
11 W	36°	950 lm	3000 K	Black	Black	327754	75

DIMMABLE DRIVER* (NOT INCLUDED/OPTIONAL) ONLY 11W

	POWER	OUTPUT	MEASURE	CODE	€
1-10V/Push	20 W	250 mA	111 x 22 x 52 mm	217253	60
DALI/Push	12 W	250 mA	132 x 20 x 30 mm	202396	55

*The dimmable power supplies must be ordered in concomitance with the product and will be included inside the fittings by replacing the on-off power supply.

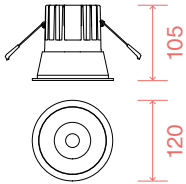
GAME TRIM ROUND

RECESSED LIGHTS



IP20 UGR:<19 CRI:≥90 LED LIFE: 50.000 h

↑ PHOTO p. 342



① 110
0,660 Kg
0,0033 m³

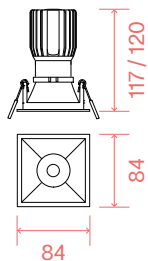
LED COB CREE (DRIVER ON/OFF INCLUDED)

POWER	BEAM	LUMEN	CCT	FRAME	FINISH	CODE	€
20 W	27°	2100 lm	2700 K	White	White	341408	90
20 W	27°	2100 lm	2700 K	White	Gold	341392	90
20 W	27°	2250 lm	3000 K	White	White	273174	90
20 W	27°	2250 lm	3000 K	White	Gold	341422	90
20 W	27°	2100 lm	2700 K	Black	Black	341378	90
20 W	27°	2100 lm	2700 K	Black	Gold	341385	90
20 W	27°	2250 lm	3000 K	Black	Black	273167	90
20 W	27°	2250 lm	3000 K	Black	Gold	341415	90

GAME TRIM SQUARE

DA INCASSO

IP20 / 65 UGR:<19 CRI: ≥90 LED LIFE: 50.000 h



75x75

0,310 Kg
0,0016 m³

LED COB CREE (DRIVER ON/OFF INCLUSO)

POWER	BEAM	LUMEN	CCT	FRAME	FINISH	CODE	€
11 W	36°	900 lm	2700 K	White	White	285443	50
11 W	36°	950 lm	3000 K	White	White	192376	50
11 W	36°	950 lm	3000 K	White	Black	192352	50
11 W	36°	900 lm	2700 K	Black	Nero	285436	50
11 W	36°	950 lm	3000 K	Black	White	192406	50
11 W	36°	950 lm	3000 K	Black	Nero	192383	50

IP65

POWER	BEAM	LUMEN	CCT	FRAME	FINISH	CODE	€
11 W	36°	950 lm	3000 K	Black	White	313207	75
11 W	36°	950 lm	3000 K	Black	Black	327761	75

DIMMABLE DRIVER* (NOT INCLUDED/OPTIONAL)

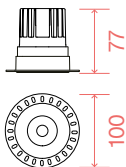
	POWER	OUTPUT	MEASURE	CODE	€
1-10V/Push	20 W	250 mA	111 x 22 x 52 mm	217253	60
DALI/Push	12 W	250 mA	132 x 20 x 30 mm	202396	55

*Gli alimentatori dimmerabili devono essere ordinati contestualmente al prodotto e verranno già inclusi all'interno degli apparecchi in sostituzione degli alimentatori on-off.

GAME TRIMLESS

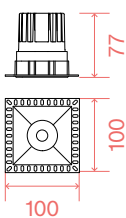
RECESSED LIGHTS

□ IP20 UGR:<19 CRI: ≥90 LED LIFE: 50.000 h



① 75

0,300 Kg
0,0011 m³



① 75x75

0,300 Kg
0,0011 m³

LED COB CREE (DRIVER ON/OFF INCLUDED)

POWER	BEAM	LUMEN	CCT	FINISH	CODE	€
11 W	36°	950 lm	3000 K	White	319667	50
11 W	36°	950 lm	3000 K	Black	319650	50

LED COB CREE (DRIVER ON/OFF INCLUDED)

POWER	BEAM	LUMEN	CCT	FINISH	CODE	€
11 W	36°	950 lm	3000 K	White	319681	50
11 W	36°	950 lm	3000 K	Black	319674	50

DIMMABLE DRIVER* (NOT INCLUDED/OPTIONAL)

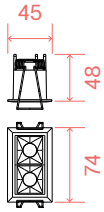
	POWER	OUTPUT	MEASURE	CODE	€
1-10V/Push	20 W	250 mA	111 x 22 x 52 mm	217253	60
DALI/Push	12 W	250 mA	132 x 20 x 30 mm	202396	55

*The dimmable power supplies must be ordered in concomitance with the product and will be included inside the fittings by replacing the on-off power supply.

LIKA TRIM

RECESSED LIGHTS

□ IP20 UGR:<16 CRI: ≥90 LED LIFE: 50.000 h

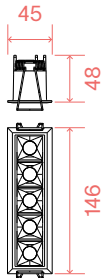


□ 68x37

0,180 Kg
0,0009 m³

LED SMD OSRAM (DRIVER ON/OFF INCLUDED)

POWER	BEAM	LUMEN	CCT	FINISH	CODE	€
5,5 W	29°	340 lm	2700 K	White + Black	341729	45
5,5 W	29°	350 lm	3000 K	White + Black	206196	45
5,5 W	29°	400 lm	4000 K	White + Black	267869	45

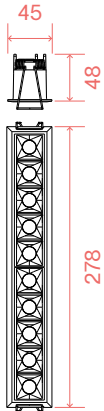


□ 140x37

0,320 Kg
0,0013 m³

LED SMD OSRAM (DRIVER ON/OFF INCLUDED)

POWER	BEAM	LUMEN	CCT	FINISH	CODE	€
12 W	29°	850 lm	2700 K	White + Black	341736	70
12 W	29°	880 lm	3000 K	White + Black	206219	70
12 W	29°	1000 lm	4000 K	White + Black	267876	70



□ 273x37

0,580 Kg
0,0022 m³

LED SMD OSRAM (DRIVER ON/OFF INCLUDED)

POWER	BEAM	LUMEN	CCT	FINISH	CODE	€
20 W	29°	1700 lm	2700 K	White + Black	341743	110
20 W	29°	1750 lm	3000 K	White + Black	206233	110
20 W	29°	2000 lm	4000 K	White + Black	267883	110

DIMMABLE DRIVER* (NOT INCLUDED/OPTIONAL)

MODEL	CONTROL	POWER	OUTPUT	MEASURE	CODE	€
5,5/12 W	DALI	12 W	700 mA	132 x 20 x 30 mm	267982	56
20 W	DALI/Push	25 W	600 mA	135 x 24 x 72 mm	268002	75

* The dimmable power supplies must be ordered in concomitance with the product and will be included inside the fittings by replacing the on-off power supply.

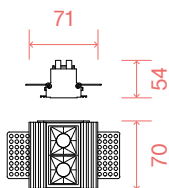
LIKA TRIMLESS

RECESSED LIGHTS



IP20 UGR:<16 CRI:≥90 LED LIFE: 50.000 h

↑ PHOTO p. 348

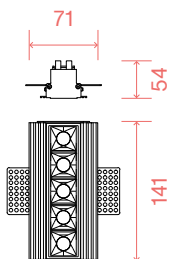


75x70

0,220 Kg
0,0006 m³

LED SMD OSRAM (DRIVER ON/OFF INCLUDED)

POWER	BEAM	LUMEN	CCT	FINISH	CODE	€
5,5 W	29°	340 lm	2700 K	Black	341750	60
5,5 W	29°	350 lm	3000 K	Black	206202	60
5,5 W	29°	400 lm	4000 K	Black	267890	60

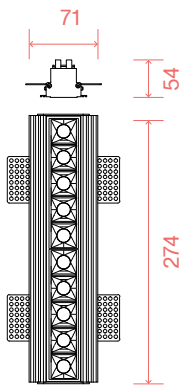


145x70

0,450 Kg
0,0013 m³

LED SMD OSRAM (DRIVER ON/OFF INCLUDED)

POWER	BEAM	LUMEN	CCT	FINISH	CODE	€
12,5 W	29°	850 lm	2700 K	Black	341767	95
12,5 W	29°	880 lm	3000 K	Black	206226	95
12,5 W	29°	1000 lm	4000 K	Black	267906	95



278x70

0,760 Kg
0,0022 m³

LED SMD OSRAM (DRIVER ON/OFF INCLUDED)

POWER	BEAM	LUMEN	CCT	FINISH	CODE	€
19,5 W	29°	1700 lm	2700 K	Black	341774	150
19,5 W	29°	1750 lm	3000 K	Black	206240	150
19,5 W	29°	2000 lm	4000 K	Black	267913	150

DIMMABLE DRIVER* (NOT INCLUDED/OPTIONAL)

MODEL	CONTROL	POWER	OUTPUT	MEASURE	CODE	€
5,5/12 W	DALI	12 W	700 mA	132 x 20 x 30 mm	267982	56
20 W	DALI/Push	25 W	600 mA	135 x 24 x 72 mm	268002	75

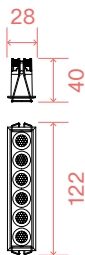
* The dimmable power supplies must be ordered in concomitance with the product and will be included inside the fittings by replacing the on-off power supply.

LIKA SLIM

RECESSED LIGHTS



IP20 UGR:<19 CRI: ≥90 LED LIFE: 50.000 h

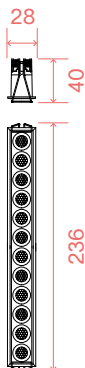


117x23

0,180 Kg
0,0013 m³

LED SMD (DRIVER ON/OFF INCLUDED)

POWER	BEAM	LUMEN	CCT	FINISH	CODE	€
10 W	32°	900 lm	2700 K	Black	341644	66
10 W	32°	1000 lm	3000 K	White	327501	66
10 W	32°	1000 lm	3000 K	Black	305813	66
10 W	32°	1200 lm	4000 K	White	341675	66
10 W	32°	1200 lm	4000 K	Black	341668	66



231x23

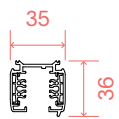
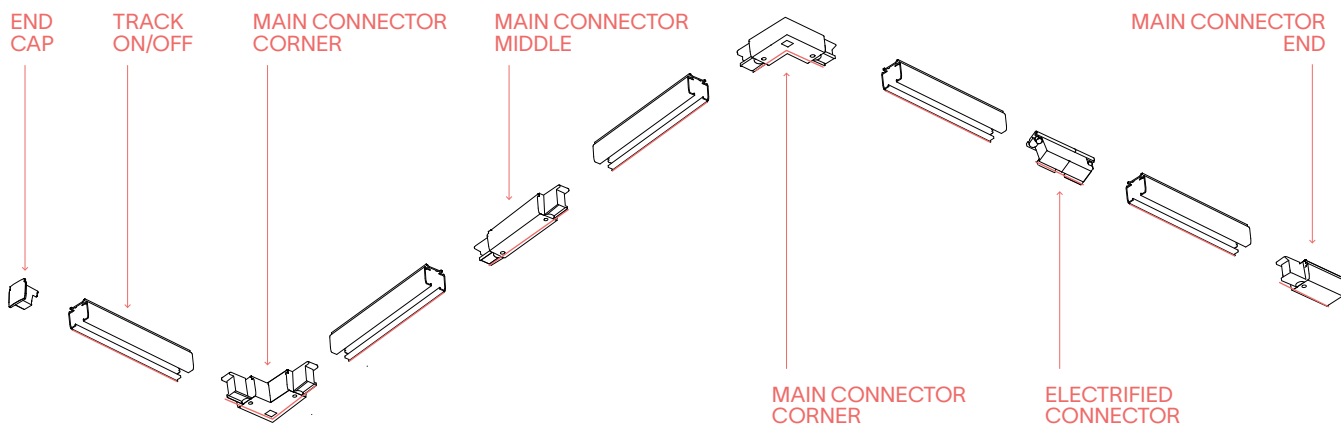
0,300 Kg
0,0022 m³

LED SMD (DRIVER ON/OFF INCLUDED)

POWER	BEAM	LUMEN	CCT	FINISH	CODE	€
20 W	32°	1800 lm	2700 K	Black	341682	110
20 W	32°	2000 lm	3000 K	White	327518	110
20 W	32°	2000 lm	3000 K	Black	305837	110
20 W	32°	2400 lm	4000 K	White	341712	110
20 W	32°	2400 lm	4000 K	Black	341705	110

LINK 3-PHASE TRIMLESS ON/OFF

TRACKS



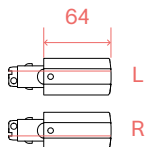
TRACK

LENGTH	WEIGHT	VOLUME	FINISH	CODE	€
1000 mm	0,94 Kg	0,0016 m ³	White	243269	30
1000 mm	0,94 Kg	0,0016 m ³	Black	243252	30
2000 mm	1,72 Kg	0,0074 m ³	White	187976	60
2000 mm	1,72 Kg	0,0074 m ³	Black	187983	60
3000 mm	2,55 Kg	0,0110 m ³	White	187990	95
3000 mm	2,55 Kg	0,0110 m ³	Black	188003	95

	REQUIRED	N° CABLES	CABLES LENGTH	FINISH	CODE	€
KIT SURFACE	YES - 1 Kit x 1000 mm			White	169972	5
KIT SURFACE	YES - 1 Kit x 1000 mm			Black	169989	5
SUSPENSION KIT	YES - 1 Kit x 1000 mm	1	3000 mm	White	242705	13
SUSPENSION KIT	YES - 1 Kit x 1000 mm	1	3000 mm	Black	243283	13
SUSPENSION KIT	YES - 1 Kit x 1000 mm	1	5000 mm	White	243245	15
SUSPENSION KIT	YES - 1 Kit x 1000 mm	1	5000 mm	Black	243238	15
END CAP	YES			White	169613	2
END CAP	YES			Black	169620	2

LINK 3-PHASE TRIMLESS ON/OFF

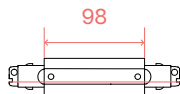
TRACKS



MAIN CONNECTOR END

SIDE	FINISH	CODE	€
L	White	169583	9
L	Black	169576	9
R	White	169590	9
R	Black	169606	9

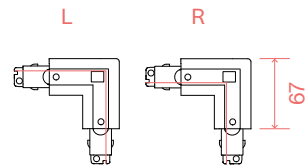
0,060 Kg
0,0002 m³



MAIN CONNECTOR MIDDLE

FINISH	CODE	€
White	227580	17
Black	227597	17

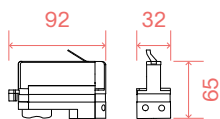
0,120 Kg
0,0004 m³



MAIN CONNECTOR CORNER

SIDE	FINISH	CODE	€
L	White	169705	17
L	Black	169712	17
R	White	169736	17
R	Black	169729	17

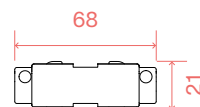
0,110 Kg
0,0005 m³



TRACK ADAPTOR

FINISH	CODE	€
White	194257	9
Black	194301	9

0,080 Kg
0,0002 m³



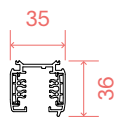
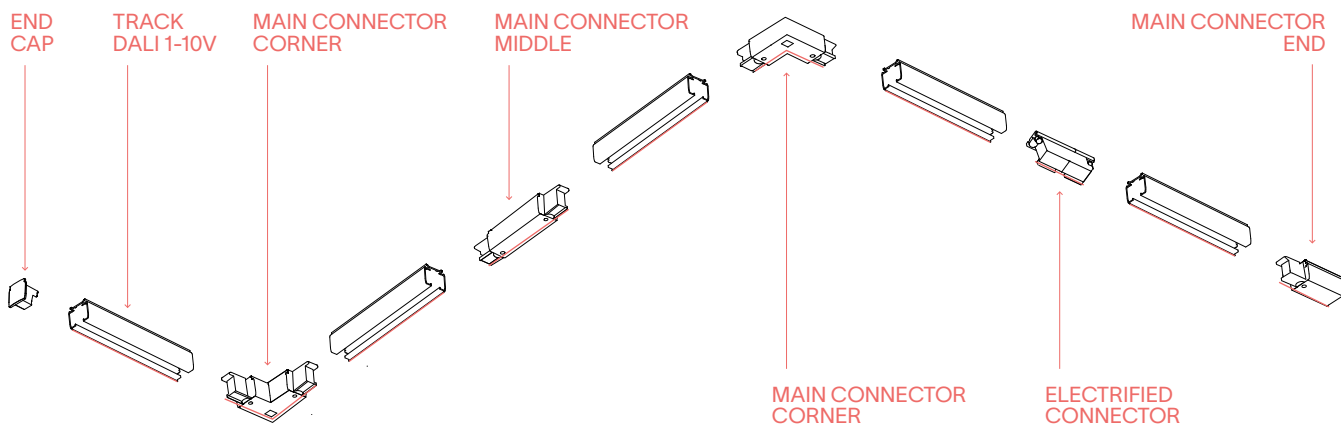
ELECTRIFIED CONNECTOR

FINISH	CODE	€
White	169637	7
Black	169644	7

0,030 Kg
0,0001 m³

LINK 3-PHASE TRIMLESS DALI - 1-10V

TRACKS



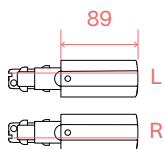
TRACK

LENGTH	WEIGHT	VOLUME	FINISH	CODE	€
1000 mm	0,94 Kg	0,0016 m ³	White	246468	38
1000 mm	0,94 Kg	0,0016 m ³	Black	246451	38
2000 mm	1,93 Kg	0,0032 m ³	White	247007	80
2000 mm	1,93 Kg	0,0032 m ³	Black	246901	80
3000 mm	2,87 Kg	0,0048 m ³	White	247625	115
3000 mm	2,87 Kg	0,0048 m ³	Black	247618	115

	REQUIRED	N° CABLES	CABLES LENGTH	FINISH	CODE	€
KIT SURFACE	YES - 1 Kit x 1000 mm			White	169972	5
KIT SURFACE	YES - 1 Kit x 1000 mm			Black	169989	5
SUSPENSION KIT	YES - 1 Kit x 1000 mm	1	3000 mm	White	242705	13
SUSPENSION KIT	YES - 1 Kit x 1000 mm	1	3000 mm	Black	243283	13
SUSPENSION KIT	YES - 1 Kit x 1000 mm	1	5000 mm	White	243245	15
SUSPENSION KIT	YES - 1 Kit x 1000 mm	1	5000 mm	Black	243238	15
END CAP	YES			White	169613	2
END CAP	YES			Black	169620	2

LINK 3-PHASE TRIMLESS DALI - 1-10V

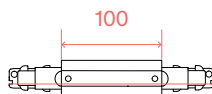
TRACKS



MAIN CONNECTOR END

SIDE	FINISH	CODE	€
L	White	246529	13
L	Black	246512	13
R	White	246543	13
R	Black	246536	13

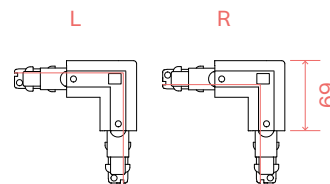
0,079 Kg
0,0002 m³



MAIN CONNECTOR MIDDLE

FINISH	CODE	€
White	246581	25
Black	246574	25

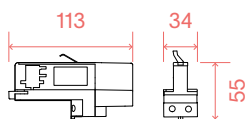
0,129 Kg
0,0004 m³



MAIN CONNECTOR CORNER

SIDE	FINISH	CODE	€
L	White	246604	25
L	Black	246598	25
R	White	246628	25
R	Black	246611	25

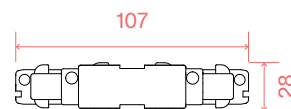
0,130 Kg
0,0006 m³



TRACK ADAPTOR

FINISH	CODE	€
White	246505	15
Black	246499	15

0,063 Kg
0,0003 m³



ELECTRIFIED CONNECTOR

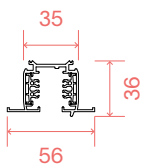
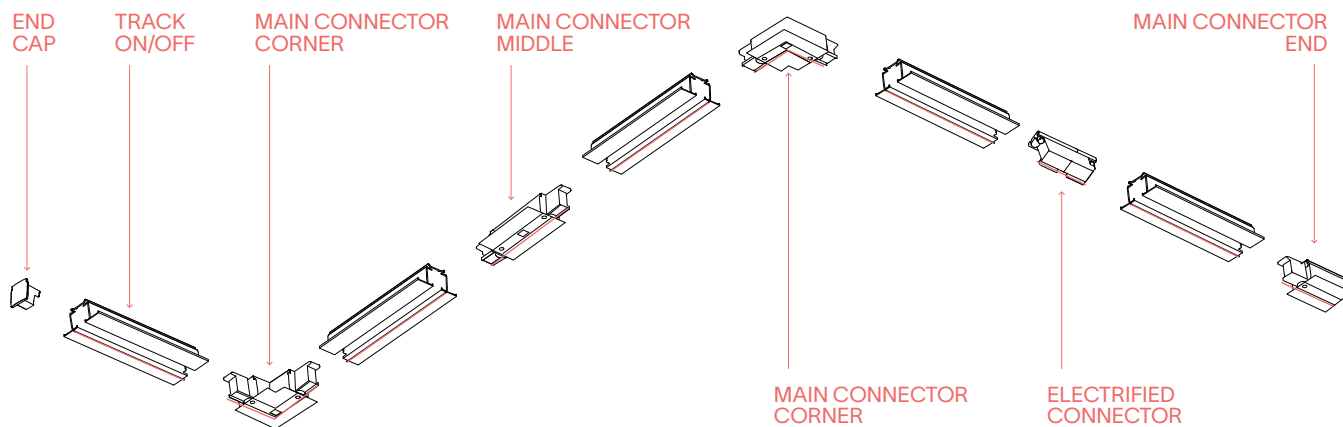
FINISH	CODE	€
White	246567	9
Black	246550	9

0,050 Kg
0,0001 m³

LINK 3-PHASE TRIM ON/OFF

TRACKS

IP20



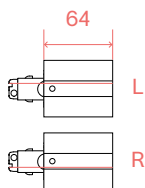
TRACK

LENGTH	WEIGHT	VOLUME	FINISH	CODE	€
2000 mm	1,92 Kg	0,0132 m ³	White	188010	60
2000 mm	1,92 Kg	0,0132 m ³	Black	188027	60

	REQUIRED	FINISH	CODE	€
KIT RECESSED	YES - 1 Kit x 1000 mm	Aluminum	188195	5
END CAP	YES	White	169613	2
END CAP	YES	Black	169620	2

LINK 3-PHASE TRIM ON/OFF

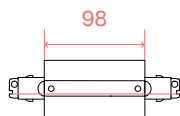
TRACKS



MAIN CONNECTOR END

SIDE	FINISH	CODE	€
L	White	188072	7
L	Black	188089	7
R	White	188058	7
R	Black	188065	7

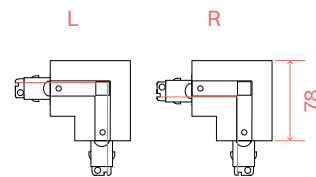
0,070 Kg
0,0002 m³



MAIN CONNECTOR MIDDLE

FINISH	CODE	€
White	227689	15
Black	227672	15

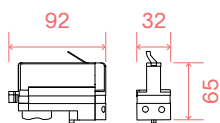
0,130 Kg
0,0004 m³



MAIN CONNECTOR CORNER

SIDE	FINISH	CODE	€
L	White	188119	15
L	Black	188126	15
R	White	188096	15
R	Black	188102	15

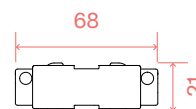
0,120 Kg
0,0006 m³



TRACK ADAPTOR

FINISH	CODE	€
White	194257	9
Black	194301	9

0,080 Kg
0,0002 m³



ELECTRIFIED CONNECTOR

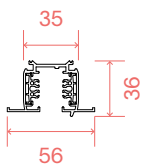
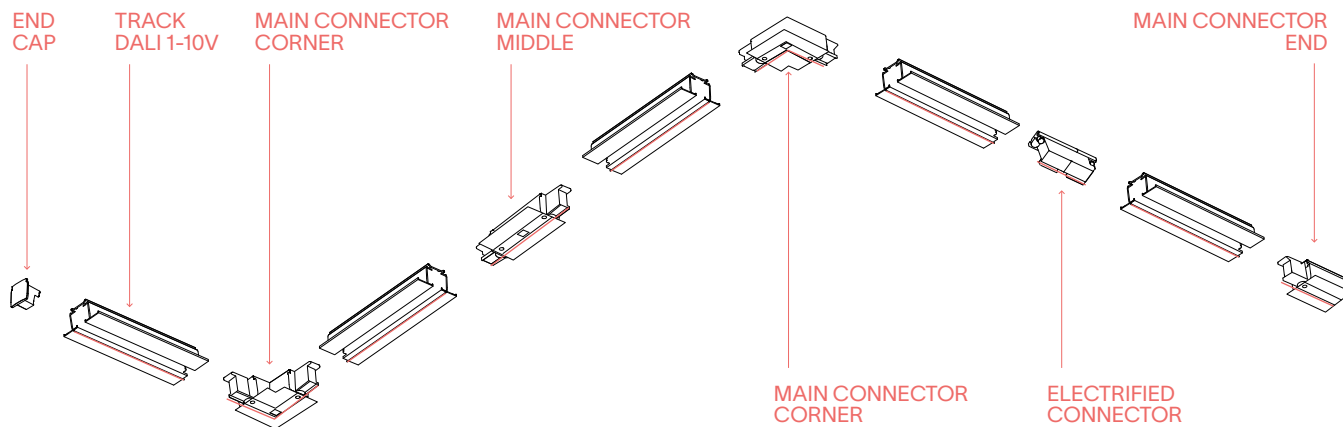
FINISH	CODE	€
White	169637	7
Black	169644	7

0,030 Kg
0,0001 m³

LINK 3-PHASE TRIM DALI - 1-10V

TRACKS

IP20



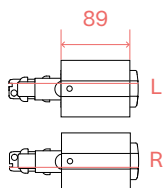
TRACK

LENGTH	WEIGHT	VOLUME	FINISH	CODE	€
2000 mm	2,11 Kg	0,0048 m ³	White	246895	75
2000 mm	2,11 Kg	0,0048 m ³	Black	249629	75

	REQUIRED	FINISH	CODE	€
KIT RECESSED	YES - 1 Kit x 1000 mm	Aluminum	188195	5
END CAP	YES	White	169613	2
END CAP	YES	Black	169620	2

LINK 3-PHASE TRIM DALI - 1-10V

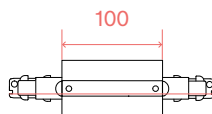
TRACKS



MAIN CONNECTOR END

SIDE	FINISH	CODE	€
L	White	256085	10
L	Black	256078	10
R	White	256146	10
R	Black	256122	10

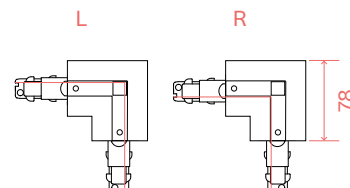
0,089 Kg
0,0004 m³



MAIN CONNECTOR MIDDLE

FINISH	CODE	€
White	256115	25
Black	256092	25

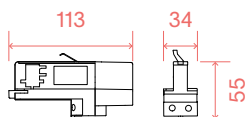
0,150 Kg
0,0005 m³



MAIN CONNECTOR CORNER

SIDE	FINISH	CODE	€
L	White	256030	25
L	Black	255996	25
R	White	256061	25
R	Black	256047	25

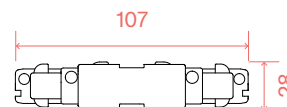
0,150 Kg
0,0006 m³



TRACK ADAPTOR

FINISH	CODE	€
White	246505	15
Black	246499	15

0,063 Kg
0,0003 m³



ELECTRIFIED CONNECTOR

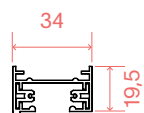
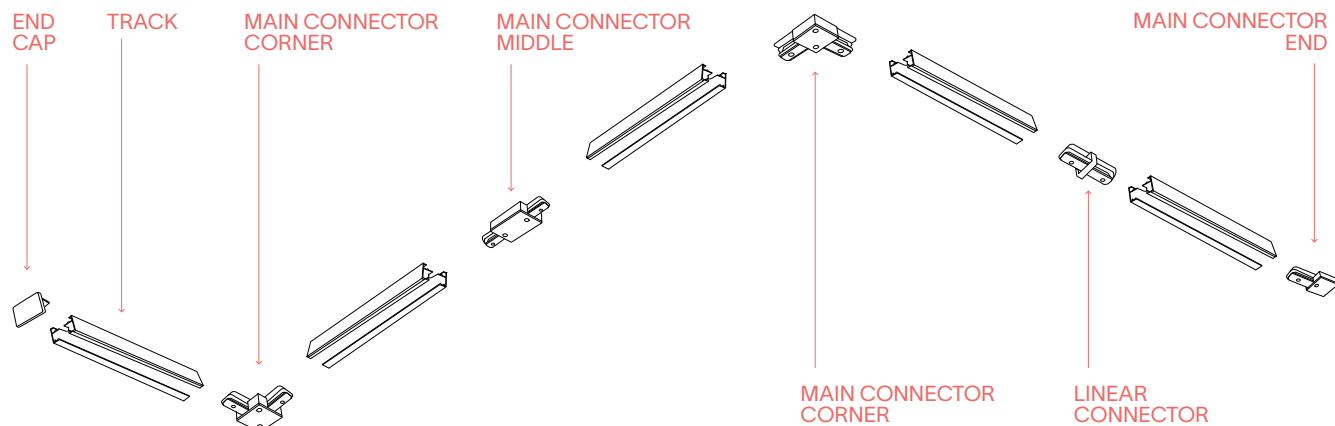
FINISH	CODE	€
White	246567	9
Black	246550	9

0,050 Kg
0,0001 m³

LINK 1-PHASE SURFACE ON/OFF

TRACKS

IP20



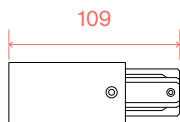
TRACK

LENGTH	WEIGHT	VOLUME	FINISH	CODE	€
1000 mm	0,42 Kg	0,0007 m ³	Black	337371	13
2000 mm	0,83 Kg	0,0017 m ³	Black	342801	24
3000 mm	1,22 Kg	0,0022 m ³	Black	344973	35

	REQUIRED	FINISH	CODE	€
END CAP	YES	Black	337395	3

LINK 1-PHASE SURFACE ON/OFF

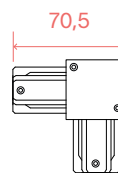
TRACKS



MAIN CONNECTOR

FINISH	CODE	€
Black	337388	3

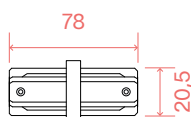
0,060 Kg
0,0001 m³



MAIN CONNECTOR CORNER

FINISH	CODE	€
Black	337401	3

0,060 Kg
0,0001 m³



LINEAR CONNECTOR

FINISH	CODE	€
Black	337418	3

0,040 Kg
0,0001 m³



MAIN CONNECTOR MIDDLE

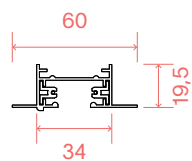
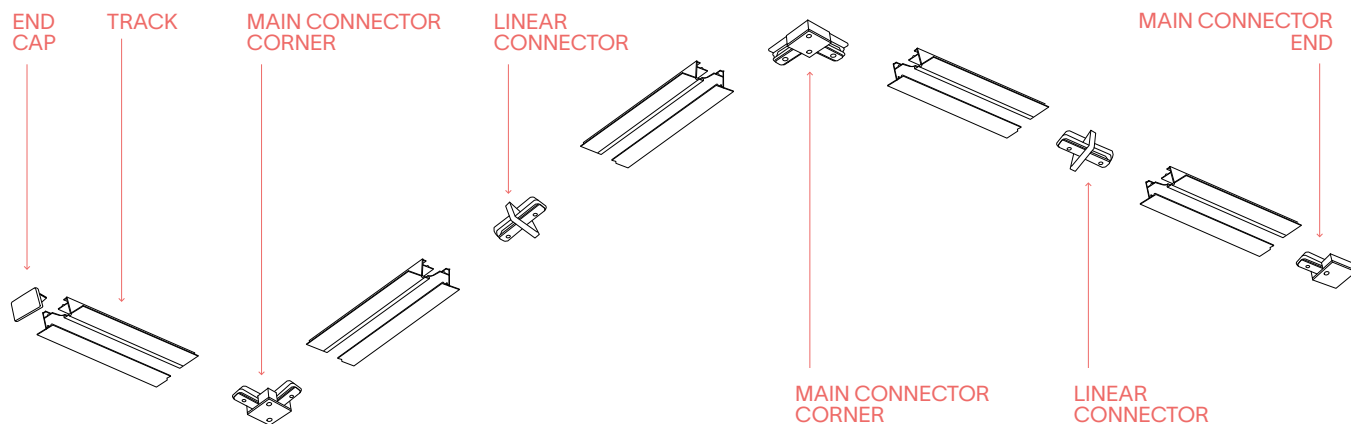
FINISH	CODE	€
Black	337425	5

0,070 Kg
0,0001 m³

LINK 1-PHASE RECESSED

TRACKS

IP20



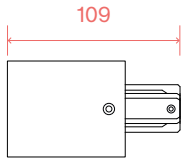
TRACK

LENGHT	WEIGHT	VOLUME	FINISH	CODE	€
1000 mm	0,49 Kg	0,0013 m ³	Black	342818	17
2000 mm	0,94 Kg	0,0027 m ³	Black	342825	32
3000 mm	1,39 Kg	0,0041 m ³	Black	344966	47

	REQUIRED	FINISH	CODE	€
KIT RECESSED	SI - 1 Kit x 1000 mm	Aluminum	188195	5
END CAP	SI	Black	337395	3

LINK 1-PHASE RECESSED

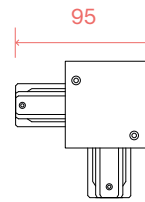
TRACKS



MAIN CONNECTOR

FINISH	CODE	€
Black	342832	3

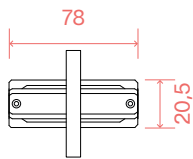
0,070 Kg
0,0001 m³



MAIN CONNECTOR CORNER

FINISH	CODE	€
Black	342849	4

0,100 Kg
0,0001 m³



LINEAR CONNECTOR

FINISH	CODE	€
Black	342856	3

0,040 Kg
0,0001 m³

LINUS

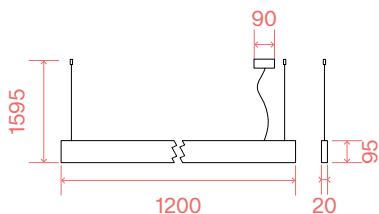
SYSTEMS



MacAdam: SDCM 3 CRI: ≥90 LED LIFE: 50.000 h

↑ PHOTO p. 324

2,550 Kg
0,0158 m³
Cable length
1500 mm



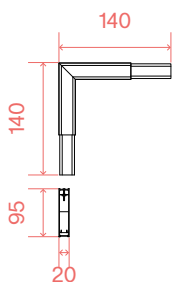
LED SMD (UP-LIGHT INCLUDED - DRIVER 1-10V INCLUDED)

POWER	BEAM	LUMEN	CCT	FINISH	CODE	€
32 W	104°	1500 lm	3000 K	White	241968	220
32 W	104°	1500 lm	3000 K	Black	241975	220
32 W	104°	1750 lm	4000 K	White	268231	220
32 W	104°	1750 lm	4000 K	Black	268217	220

UP-LIGHT INFO

POWER	BEAM	LUMEN	CCT
32 W	104°	1500 lm	3000 K
32 W	104°	1750 lm	4000 K

CORNER (OPTIONAL - UP-LIGHT NOT INCLUDED)



POWER	BEAM	LUMEN	CCT	FINISH	CODE	€
5,5 W	104°	640 lm	3000 K	White	241999	46
5,5 W	104°	640 lm	3000 K	Black	242002	46
5,5 W	104°	730 lm	4000 K	White	268149	46
5,5 W	104°	730 lm	4000 K	Black	268118	46

STRUCTURE CONNECTOR

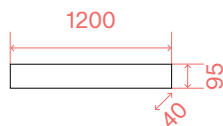
0,260 Kg
0,0023 m³

REQUIRED	CODE	€
YES - 1 Kit x connection	241982	6

WALL

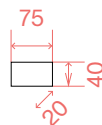


MacAdam: SDCM 3 CRI: ≥90 LED LIFE: 50.000 h



1,250 Kg
0,0158 m³
LED 32W
3000/3500 lm

FINISH	LUMEN	CODE	€
White	3000K	233840	210
White	4000K	268095	210
Black	3000K	242019	210
Black	4000K	268071	210



CONNECTOR
(NOT INCLUDED/REQUIRED)
cod. 233666, € 6



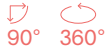
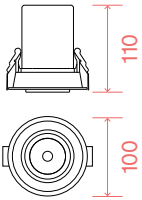
600

NOVA

RECESSED LIGHTS



IP20 CRI: ≥90 LED LIFE: 50.000 h PHOTO p. 352



ⓘ 90

0,550 Kg
0,0016 m³

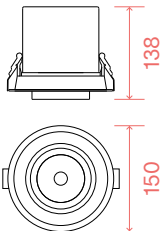
LED COB PHILIPS (DRIVER ON/OFF INCLUDED - UGR <19)

POWER	BEAM	LUMEN	CCT	FINISH	CODE	€
12 W	38°	1100 lm	2700 K	White	341859	78
12 W	38°	1100 lm	2700 K	Black	341842	78
12 W	38°	1200 lm	3000 K	White	248165	78
12 W	38°	1200 lm	3000 K	Black	248189	78
12 W	38°	1300 lm	4000 K	White	267937	78
12 W	38°	1300 lm	4000 K	Black	267920	78

DIMMABLE DRIVER* (NOT INCLUDED/OPTIONAL)

	POWER	OUTPUT	MEASURE	CODE	€
1-10V / Push	15 W	300 mA	111 x 22 x 52 mm	243993	60
DALI/ Push	12 W	300 mA	132 x 20 x 30 mm	243986	55

* The dimmable power supplies must be ordered in concomitance with the product and will be included inside the fittings by replacing the on-off power supply.



ⓘ 140

1,160 Kg
0,0039 m³

LED COB PHILIPS (DRIVER ON/OFF INCLUDED - UGR <22)

POWER	BEAM	LUMEN	CCT	FINISH	CODE	€
30 W	38°	3000 lm	2700 K	White	341873	125
30 W	38°	3000 lm	2700 K	Black	341866	125
30 W	38°	3150 lm	3000 K	White	248172	125
30 W	38°	3150 lm	3000 K	Black	248196	125
30 W	38°	3300 lm	4000 K	White	267951	125
30 W	38°	3300 lm	4000 K	Black	267944	125

DIMMABLE DRIVER* (NOT INCLUDED/OPTIONAL)

	POWER	OUTPUT	MEASURE	CODE	€
1-10V / Push	36 W	700 mA	167 x 32 x 41 mm	248370	100
DALI/ Push	36 W	700 mA	135 x 24 x 72 mm	248592	100

* The dimmable power supplies must be ordered in concomitance with the product and will be included inside the fittings by replacing the on-off power supply.

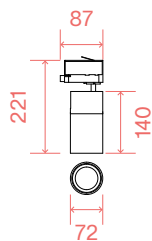
	MODEL	REQUIRED	BEAM	CODE	€
LENS	Nova 12W	NO	15°	244013	8
LENS	Nova 30W	NO	15°	248608	12

QUICK 15W

PROJECTORS



IP20 MacAdam: SDCM 3 CRI: ≥ 80 / ≥ 90 LED LIFE: 50.000 h



0,760 Kg
0,0038 m³

LED COB CITIZEN

CRI ≥ 80

POWER	BEAM	LUMEN	CCT	TRACK	FINISH	CODE	€
15 W	30°	1800 lm	3000 K	3-Phase	White	222509	145
15 W	30°	1800 lm	3000 K	3-Phase	Black	222523	145
15 W	30°	1950 lm	4000 K	3-Phase	White	222530	145
15 W	30°	1950 lm	4000 K	3-Phase	Black	222547	145

CRI ≥ 90

POWER	BEAM	LUMEN	CCT	TRACK	FINISH	CODE	€
15 W	30°	1500 lm	3000 K	3-Phase	White	222554	145
15 W	30°	1500 lm	3000 K	3-Phase	Black	222561	145
15 W	30°	1600 lm	4000 K	3-Phase	White	222578	145
15 W	30°	1600 lm	4000 K	3-Phase	Black	222585	145

	REQUIRED	BEAM	FINISH	CODE	€
FILTER HONEYCOMB	NO		Black	222608	9
LENS*	NO	15°	Clear	222592	9
LENS*	NO	45°	Clear	253558	9
LINK SINGLE CONNECTION	NO		White	170145	23
LINK SINGLE CONNECTION	NO		Black	170152	23

* The optional lens must be ordered in concomitance with the product and will be mounted inside the product as replacement for the default one.

QUICK 21W

PROJECTORS

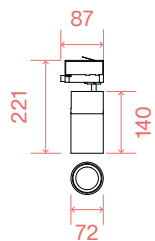


IP20

MacAdam: SDCM 3

CRI: ≥ 80 / ≥ 90

LED LIFE: 50.000 h



0,760 Kg
0,0038 m³

LED COB CITIZEN

CRI ≥ 80

POWER	BEAM	LUMEN	CCT	TRACK	FINISH	CODE	€
21 W	30°	2450 lm	3000 K	3-Phase	White	247946	155
21 W	30°	2450 lm	3000 K	3-Phase	Black	247939	155
21 W	30°	2700 lm	4000 K	3-Phase	White	247960	155
21 W	30°	2700 lm	4000 K	3-Phase	Black	247953	155

CRI ≥ 90

POWER	BEAM	LUMEN	CCT	TRACK	FINISH	CODE	€
21 W	30°	2000 lm	3000 K	3-Phase	White	247977	155
21 W	30°	2000 lm	3000 K	3-Phase	Black	225364	155
21 W	30°	2150 lm	4000 K	3-Phase	White	247991	155
21 W	30°	2150 lm	4000 K	3-Phase	Black	247984	155

	REQUIRED	BEAM	FINISH	CODE	€
FILTER HONEYCOMB	NO		Black	222608	9
LENS*	NO	15°	Clear	222592	9
LENS*	NO	45°	Clear	253558	9
LINK SINGLE CONNECTION	NO		White	170145	23
LINK SINGLE CONNECTION	NO		Black	170152	23

* The optional lens must be ordered in concomitance with the product and will be mounted inside the product as replacement for the default one.

QUICK 28W

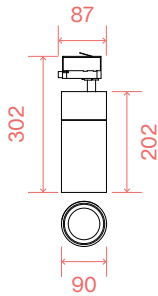
PROJECTORS



IP20 MacAdam: SDCM 3 CRI: ≥ 80 / ≥ 90 LED LIFE: 50.000 h



↑ PHOTO p. 330



1,200 Kg
0,0063 m³

LED COB CITIZEN

CRI ≥ 80

POWER	BEAM	LUMEN	CCT	TRACK	FINISH	CODE	€
28 W	30°	3550 lm	3000 K	3-Phase	White	222615	185
28 W	30°	3550 lm	3000 K	3-Phase	Black	222622	185
28 W	30°	3800 lm	4000 K	3-Phase	White	222639	185
28 W	30°	3800 lm	4000 K	3-Phase	Black	222646	185

CRI ≥ 90

POWER	BEAM	LUMEN	CCT	TRACK	FINISH	CODE	€
28 W	30°	3100 lm	3000 K	3-Phase	White	222653	185
28 W	30°	3100 lm	3000 K	3-Phase	Black	222660	185
28 W	30°	3300 lm	4000 K	3-Phase	White	222677	185
28 W	30°	3300 lm	4000 K	3-Phase	Black	222684	185

	REQUIRED	BEAM	FINISH	CODE	€
FILTER HONEYCOMB	NO		Black	222714	10
LENS*	NO	18°	Clear	222691	10
LENS*	NO	45°	Clear	222707	10
LINK SINGLE CONNECTION	NO		White	170145	23
LINK SINGLE CONNECTION	NO		Black	170152	23

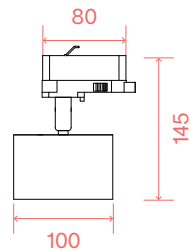
* The optional lens must be ordered in concomitance with the product and will be mounted inside the product as replacement for the default one.

SPIKE TRACK

PROJECTORS



IP20



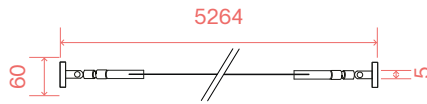
0,370 Kg
0,0027 m³
GX53 max 1 x 9W

(RECOMMENDED)

LUMEN	CCT	CODE	€
910 lm	3000 K	123936	5
FINISH		CODE	€
White		344942	60
Black		336626	60

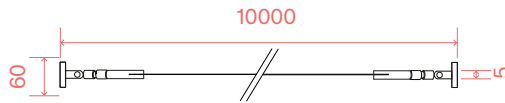


Bulbs LED GX53 9W 3000K included. Cod. 123936



STRIP LED SUPPORT

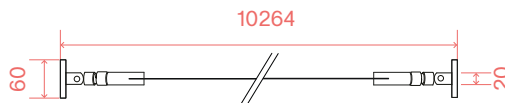
LENGTH	WEIGHT	VOLUME	FINISH	CODE	€
5000 mm	0,06 Kg	0,0029 m ³	Steel	344935	150
5000 mm	0,06 Kg	0,0029 m ³	White	344928	150
5000 mm	0,06 Kg	0,0029 m ³	Black	344911	150



LENGTH	WEIGHT	VOLUME	FINISH	CODE	€
10000 mm	0,08 Kg	0,0029 m ³	Steel	344904	165
10000 mm	0,08 Kg	0,0029 m ³	White	344898	165
10000 mm	0,08 Kg	0,0029 m ³	Black	344881	165



LENGTH	WEIGHT	VOLUME	FINISH	CODE	€
5000 mm	0,35 Kg	0,0234 m ³	Steel	258300	150
5000 mm	0,35 Kg	0,0234 m ³	White	302256	150
5000 mm	0,35 Kg	0,0234 m ³	Black	302263	150



LENGTH	WEIGHT	VOLUME	FINISH	CODE	€
10000 mm	0,45 Kg	0,0029 m ³	Steel	302270	175
10000 mm	0,45 Kg	0,0029 m ³	White	302287	175
10000 mm	0,45 Kg	0,0029 m ³	Black	302294	175

RECOMMENDED STRIP LED AND DRIVER


STRIP LED (SMD 2835 180 LED/M CRI ≥90 50.000H)

POWER	IP	LUMEN	CCT	LENGTH	CODE	€
8 W/m	IP20	670 lm/m	2700 K	5x5000 mm	345772	50
8 W/m	IP20	700 lm/m	3000 K	5x5000 mm	345789	50
8 W/m	IP20	750 lm/m	4000 K	5x5000 mm	345796	50

STRIP LED (SMD 2835 120 LED/M CRI ≥90 50.000H)

POWER	IP	LUMEN	CCT	LENGTH	CODE	€
5 W/m	IP20	470 lm/m	2700 K	8x5000 mm	346328	50
5 W/m	IP20	490 lm/m	3000 K	8x5000 mm	346335	50
5 W/m	IP20	510 lm/m	4000 K	8x5000 mm	346359	50
5 W/m	IP65	460 lm/m	3000 K	8x5000 mm	346342	60
5 W/m	IP65	500 lm/m	4000 K	8x5000 mm	346366	60
10 W/m	IP20	910 lm/m	2700 K	8x5000 mm	346373	50
10 W/m	IP20	940 lm/m	3000 K	8x5000 mm	346380	50
10 W/m	IP20	970 lm/m	4000 K	8x5000 mm	346403	50
10 W/m	IP65	960 lm/m	3000 K	8x5000 mm	346397	60
10 W/m	IP65	1040 lm/m	4000 K	8x5000 mm	346410	60
15 W/m	IP20	1400 lm/m	2700 K	10x5000 mm	272498	55
15 W/m	IP20	1450 lm/m	3000 K	10x5000 mm	272481	55
15 W/m	IP20	1600 lm/m	4000 K	10x5000 mm	272474	55
15 W/m	IP65	1400 lm/m	3000 K	10x5000 mm	272504	75
15 W/m	IP65	1480 lm/m	4000 K	10x5000 mm	287959	75

DRIVER (ON/OFF)

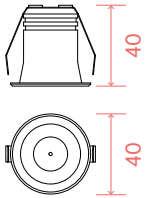
POWER	OUTPUT	CLASS	MEASURE (L X H X W)	DRIVER BOX	CODE	€
30 W	24 Vdc		140 x 28 x 45 mm	255 x 55 x 75 mm	124070	17
60 W	24 Vdc		186 x 33 x 50 mm	255 x 55 x 75 mm	124087	25
150 W	24 Vdc		268 x 31 x 45 mm	330 x 60 x 80 mm	124117	45

VIRUS

RECESSED LIGHTS



IP20 CRI: ≥90 LED LIFE: 50.000 h [↑ PHOTO p. 358](#)



① 30

0,070 Kg
0,0003 m³

LED SMD OSRAM (DRIVER ON/OFF INCLUDED)

POWER	BEAM	LUMEN	CCT	FRAME	FINISH	CODE	€
3 W	20°	210 lm	3000 K	White	White	244808	32
3 W	20°	210 lm	3000 K	White	Gold	244822	32
3 W	20°	210 lm	3000 K	Black	Black	244846	32
3 W	20°	210 lm	3000 K	Black	Gold	244853	32

ZEUS

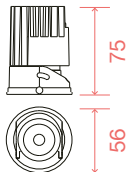
RECESSED LIGHTS



IP20 MacAdam: SDCM 3 UGR: <19 CRI: ≥90 LED LIFE: 50.000 h



[↑ PHOTO p. 362](#)



0,300 Kg
0,0014 m³

	REQUIRED	MODEL	FINISH	CODE	€
LENS 20°	No	13 W	Clear	323688	4
LENS 20°	No	21 W	Clear	323985	6
FILTER HONEYCOMB	No	13 W	Black	323671	4
FILTER HONEYCOMB	No	21 W	Black	323961	6

LED COB CITIZEN (REQUIRED - DRIVER ON/OFF INCLUDED)

POWER	BEAM	LUMEN	CCT	FINISH	CODE	€
13 W	40°	980 lm	2700 K	Grey	324807	65
13 W	40°	1020 lm	3000 K	Grey	324814	65
13 W	40°	1050 lm	4000 K	Grey	324821	65

DIMMABLE DRIVER* (OPTIONAL)

	POWER	OUTPUT	MEASURE	CODE	€
1-10V	21 W	350 mA	122 x 25 x 40 mm	324906	25
DALI / Push	20 W	350 mA	120 x 29 x 51 mm	324913	70

*The dimmable power supplies must be ordered in concomitance with the product and will be included inside the fittings by replacing the on-off power supply.

ZEUS

RECESSED LIGHTS

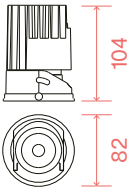


IP20 MacAdam: SDCM 3 UGR: <19 CRI: ≥90 LED LIFE: 50.000 h



↑ PHOTO p. 362

LED COB CITIZEN (REQUIRED - DRIVER TRIDONIC ON/OFF INCLUDED)



POWER	BEAM	LUMEN	CCT	FINISH	CODE	€
21 W	40°	1900 lm	2700 K	Grey	324838	105
21 W	40°	2000 lm	3000 K	Grey	324845	105
21 W	40°	2200 lm	4000 K	Grey	324852	105

DIMMABLE DRIVER (NOT INCLUDED/OPTIONAL)

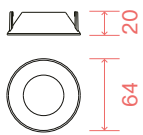
0,590 Kg
0,0029 m³

	POWER	OUTPUT	MEASURE	CODE	€	
	1-10V	20 W	500 mA	110 x 22 x 52 mm	324920	60
	DALI / Push	20 W	500 mA	120 x 29 x 51 mm	324937	70

*The dimmable power supplies must be ordered in concomitance with the product and will be included inside the fittings by replacing the on-off power supply.

ZEUS ROUND

FRAME AND REFLECTOR

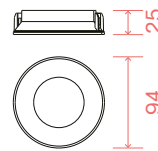


0,030 Kg
0,0003 m³

REFLECTOR (REQUIRED)

13 W

FINISH	CODE	€
White	323589	8
Black	323619	8
Gold	323602	8

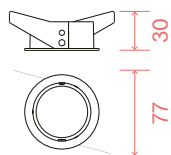


0,040 Kg
0,0007 m³

REFLECTOR (REQUIRED)

21 W

FINISH	CODE	€
White	323763	12
Black	323770	12
Gold	323794	12



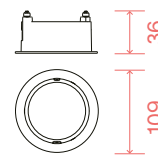
① 70

0,100 Kg
0,0005 m³

FRAME TRIM (REQUIRED)

13 W

FINISH	CODE	€
White	324869	15
Black	323527	15



① 100

0,130 Kg
0,0010 m³

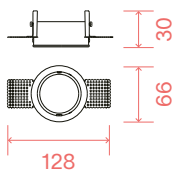
FRAME TRIM (REQUIRED)

21 W

FINISH	CODE	€
White	324883	18
Black	324005	18

ZEUS ROUND

FRAME AND REFLECTOR



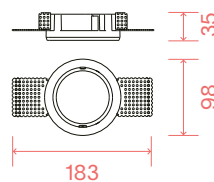
FRAME TRIMLESS (REQUIRED)

13 W

FINISH	CODE	€
White	323541	18

Ⓜ 73

0,120 Kg
0,0005 m³



FRAME TRIMLESS (REQUIRED)

21 W

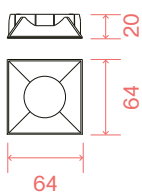
FINISH	CODE	€
White	323725	35

Ⓜ 105

0,160 Kg
0,0008 m³

ZEUS SQUARE

FRAME AND REFLECTOR

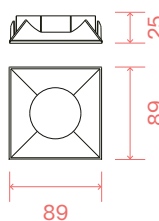


REFLECTOR (REQUIRED)

13 W

FINISH	CODE	€
White	323633	8
Black	323657	8
Gold	323640	8

0,030 Kg
0,0003 m³

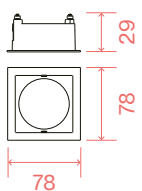


REFLECTOR (REQUIRED)

21 W

FINISH	CODE	€
White	323800	12
Black	323817	12
Gold	323831	12

0,050 Kg
0,0007 m³



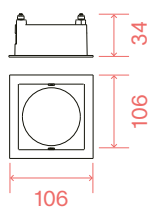
FRAME TRIM (REQUIRED)

13 W

FINISH	CODE	€
White	324876	15
Black	323534	15

Ⓜ 68x68

0,100 Kg
0,0005 m³



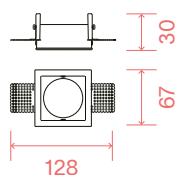
FRAME TRIM (REQUIRED)

21 W

FINISH	CODE	€
White	324890	18
Black	323718	18

Ⓜ 96x96

0,130 Kg
0,0010 m³



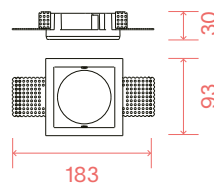
FRAME TRIMLESS (REQUIRED)

13 W

FINISH	CODE	€
White	323558	18

Ⓜ 68x68

0,120 Kg
0,0005 m³



FRAME TRIMLESS (REQUIRED)

21 W

FINISH	CODE	€
White	323732	35

Ⓜ 96x96

0,160 Kg
0,0008 m³

AGOS

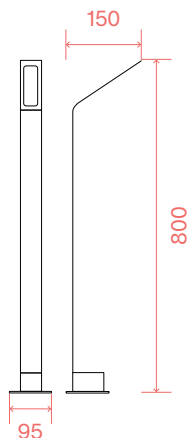
FLOOR



IP54



PHOTO p. 370

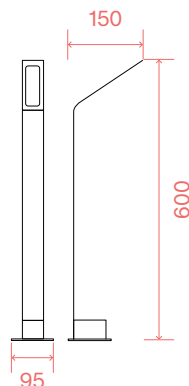


FINISH	CCT	CODE	€
Anthracite	3000 K	254319	100
Anthracite	4000 K	268422	100
Black	3000 K	326733	100
Black	4000 K	326757	100
Coffee	3000 K	326726	100
Coffee	4000 K	326740	100



LED source 3000/4000 K,
25.000 h life.

1,100 Kg
0,0127 m³
LED 6,5W / 670/730 lm



FINISH	CCT	CODE	€
Anthracite	3000 K	254388	80
Anthracite	4000 K	268439	80
Black	3000 K	326696	80
Black	4000 K	326719	80
Coffee	3000 K	326689	80
Coffee	4000 K	326702	80



LED source 3000/4000 K,
25.000 h life.

0,950 Kg
0,0096 m³
LED 6,5W / 670/730 lm

ANDROMEDA

WALL



IP55



PHOTO p. 378

1,630 Kg
0,0052 m³
E27 max 2 x 60W

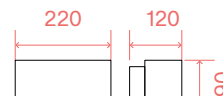


(RECOMMENDED)

LUMEN	CCT	CODE	€
580 lm	4000 K	151960	2

FINISH	CODE	€
White	100364	85
Grey	163543	85
Anthracite	092355	85
Black	100371	85
Coffee	163550	85

1,000 Kg
0,0039 m³
E27 max 1 x 60W



(RECOMMENDED)

LUMEN	CCT	CODE	€
580 lm	4000 K	151960	2

FINISH	CODE	€
White	066868	55
Grey	158822	55
Anthracite	061580	55
Black	061597	55
Coffee	163536	55

ATOM

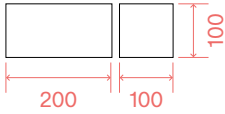
WALL



IP54



PHOTO p. 382

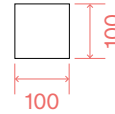


FINISH	CODE	€
White	328652	135
Anthracite	313412	135
Black	328676	135
Coffee	328669	135

1,160 Kg
0,0025 m³
LED 25W / 2100 lm



LED source 3000 K,
30.000 h life.



FINISH	CODE	€
White	313436	70
Anthracite	313429	70
Black	313450	70
Coffee	313443	70

0,660 Kg
0,0013 m³
LED 12W / 1050 lm



LED source 3000 K,
30.000 h life.

GUN

WALL



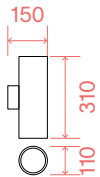
IP54



PHOTO p. 388



IP44

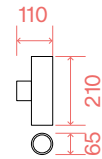


(RECOMMENDED)

LUMEN	CCT	CODE	€
580 lm	4000 K	151960	2

FINISH	CODE	€
White	092300	72
Aluminum	033020	72
Grey	163604	72
Anthracite	236858	72
Black	092317	72
Coffee	163611	72

1,350 Kg
0,0071 m³
E27 max 2 x 60W



(RECOMMENDED)

LUMEN	CCT	CODE	€
430 lm	4000 K	253497	3

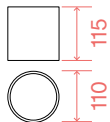
FINISH	CODE	€
White	100388	65
Aluminum	033013	65
Grey	163628	65
Anthracite	236841	65
Black	100395	65
Coffee	163635	65

0,720 Kg
0,0024 m³
GU10 max 2 x 35W

CEILING



IP44



(RECOMMENDED)

LUMEN	CCT	CODE	€
430 lm	4000 K	253497	3

FINISH	CODE	€
White	122663	54
Aluminum	092324	54
Grey	163642	54
Anthracite	236865	54
Black	122687	54
Coffee	163666	54

0,490 Kg
0,0030 m³
GU10 max 1 x 28W

JEDI

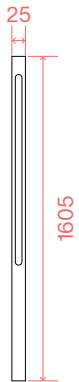
FLOOR



IP65



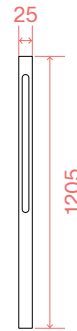
PHOTO p. 396



1,280 Kg
0,0065 m³
LED 25W / 2600 lm

FINISH	CODE	€
Anthracite	306803	155
Black	293202	155

LED source 3000 K,
30.000 h life.



1,030 Kg
0,0050 m³
LED 19W / 2050 lm

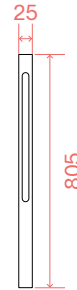
FINISH	CODE	€
Anthracite	306797	125
Black	293196	125

LED source 3000 K,
30.000 h life.



Base
Not included
Optional

FINISH	CODE	€
Anthracite	308227	13
Black	308234	13



0,760 Kg
0,0036 m³
LED 12W / 1250 lm

FINISH	CODE	€
Anthracite	306780	90
Black	293189	90

LED source 3000 K,
30.000 h life.

LINEA

WALL / CEILING



IP54



PHOTO p. 402



1,750 Kg
0,0049 m³
LED 23W / 2400 lm

FINISH	CODE	€
White	328584	185
Anthracite	313504	185
Black	328607	185
Coffee	328591	185

LED source 3000 K,
30.000 h life.



1,430 Kg
0,0036 m³
LED 20W / 1950 lm

FINISH	CODE	€
White	313474	145
Anthracite	313467	145
Black	313498	145
Coffee	313481	145

LED source 3000 K,
30.000 h life.

LOLITA

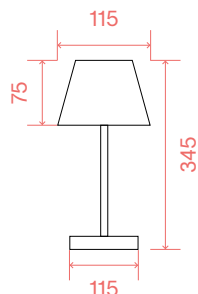
TABLE



IP54



PHOTO p. 406



0,550 Kg
0,0078 m³
LED 1,8W / 150 lm

FINISH	CODE	€
White	286723	55
Grey	286730	55
Black	286716	55
Coffee	286747	55

LED source 3000 K,
25.000 h life.

14 h life.



PUNTO

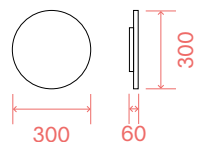
WALL / CEILING



IP54



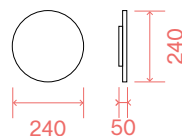
PHOTO p.414



2,090 Kg
0,0135 m³
LED 16W / 1750 lm

FINISH	CODE	€
White	328553	150
Anthracite	313566	150
Black	328577	150
Coffee	328560	150

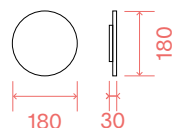
LED source 3000 K,
30.000 h life.



1,280 Kg
0,0083 m³
LED 12W / 1250 lm

FINISH	CODE	€
White	328522	125
Anthracite	313559	125
Black	328546	125
Coffee	328539	125

LED source 3000 K,
30.000 h life.



0,820 Kg
0,0018 m³
LED 9W / 950 lm

FINISH	CODE	€
White	313528	65
Anthracite	313511	65
Black	313542	65
Coffee	313535	65

LED source 3000 K,
30.000 h life.

PURE

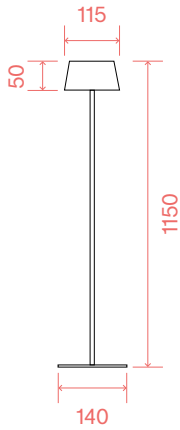
FLOOR



IP54



PHOTO p. 418



1,580 Kg
0,0058 m³
LED 1,5W / 230 lm

FINISH	CODE	€
White	311708	115
Black	328515	115
Coffee	328508	115

LED source 3000 K,
30.000 h life.

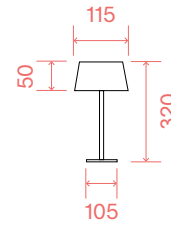
7 h life.



TABLE



IP54



0,840 Kg
0,0052 m³
LED 1,5W / 230 lm

FINISH	CODE	€
White	311685	85
Black	311678	85
Coffee	311661	85

LED source 3000 K,
30.000 h life.

7 h life.



SIRIO

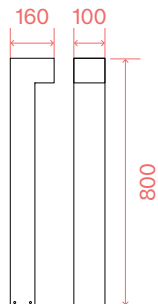
FLOOR



IP44



PHOTO p. 422

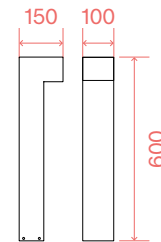


1,880 Kg
0,0181 m³
G9 max 2 x 15W

(RECOMMENDED)

LUMEN	CCT	CODE	€
530 lm	4000 K	307879	6

FINISH	CODE	€
White	115085	180
Grey	246963	180
Anthracite	115061	180
Black	115108	180
Coffee	213262	180



1,550 Kg
0,0136 m³
G9 max 2 x 15W

(RECOMMENDED)

LUMEN	CCT	CODE	€
530 lm	4000 K	307879	6

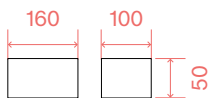
FINISH	CODE	€
White	115092	145
Grey	246970	145
Anthracite	115078	145
Black	115115	145
Coffee	213279	145

SIRIO

WALL



IP65



(RECOMMENDED)

LUMEN	CCT	CODE	€
1000 lm	4000K	154008	5

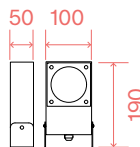
FINISH	CODE	€
White	318226	90
Grey	345611	90
Anthracite	318202	90
Black	318219	90
Coffee	318196	90

0,820 Kg
0,0018 m³
GX53 max 1 x 9W

PROJECTORS



IP65



(RECOMMENDED)

LUMEN	CCT	CODE	€
1000 lm	4000K	154008	5

FINISH	CODE	€
White	345628	110
Grey	345642	110
Anthracite	318233	110
Black	345659	110
Coffee	345635	110

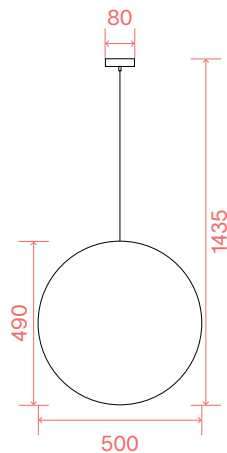
1,070 Kg
0,0021 m³
GX53 max 1 x 9W

SOLE

SUSPENSION



IP44

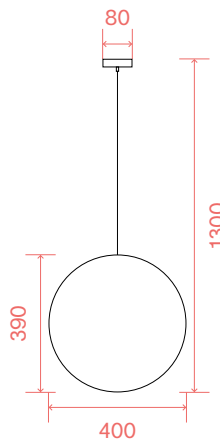


(RECOMMENDED)

LUMEN	CCT	CODE	€
1020 lm	4000 K	151991	2

FINISH	CODE	€
White	136011	180

2,970 Kg
0,1327 m³
E27 max 1 x 42W



(RECOMMENDED)

LUMEN	CCT	CODE	€
1020 lm	4000 K	151991	2

FINISH	CODE	€
White	136004	110

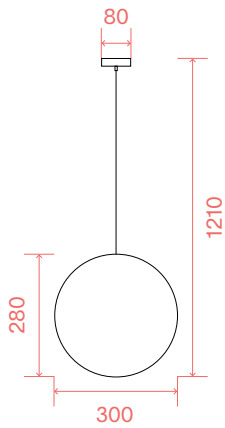
1,690 Kg
0,0776 m³
E27 max 1 x 42W

SOLE

SUSPENSION



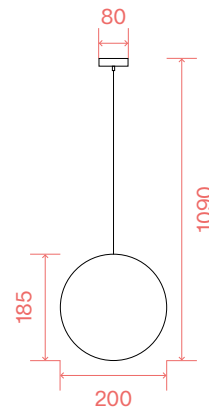
IP44



(RECOMMENDED)

LUMEN	CCT	CODE	€
1020 lm	4000 K	151991	2
FINISH		CODE	€
White		135991	95

1,360 Kg
0,0338 m³
E27 max 1 x 42W



(RECOMMENDED)

LUMEN	CCT	CODE	€
580 lm	4000 K	151960	2
FINISH		CODE	€
White		318837	90

1,300 Kg
0,0111 m³
E27 max 1 x 42W

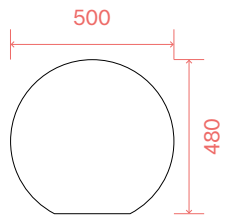
FLOOR



IP44



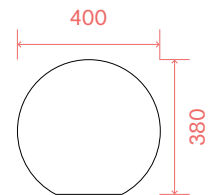
PHOTO p. 430



(RECOMMENDED)

LUMEN	CCT	CODE	€
1000 lm	4000 K	151991	2
FINISH		CODE	€
White		191614	225

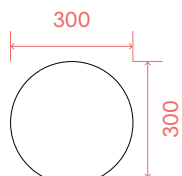
4,500 Kg
0,1460 m³
E27 max 1 x 42W



(RECOMMENDED)

LUMEN	CCT	CODE	€
1000 lm	4000 K	151991	2
FINISH		CODE	€
White		191621	150

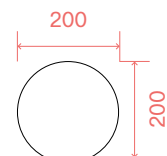
3,900 Kg
0,0741 m³
E27 max 1 x 42W



(RECOMMENDED)

LUMEN	CCT	CODE	€
1000 lm	4000 K	151991	2
FINISH		CODE	€
White		191638	120

2,700 Kg
0,0322 m³
E27 max 1 x 42W



(RECOMMENDED)

LUMEN	CCT	CODE	€
600 lm	4000 K	151960	2
FINISH		CODE	€
White		318820	110

1,200 Kg
0,0139 m³
E27 max 1 x 42W

STARLIGHT

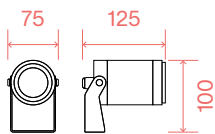
PROJECTORS



MacAdam: SDCM 3 IP68 CRI: ≥90 LED LIFE: 50.000 h



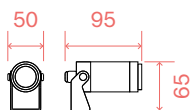
↑ PHOTO p. 436



LED COB BRIDGELUX (DRIVER NOT INCLUDED)

POWER	BEAM	LUMEN	CCT	FINISH	CODE	€
10 W	30°	930 lm	3000 K	Dark Grey	248387	250
10 W	30°	1000 lm	4000 K	Dark Grey	245072	250

0,950 Kg
0,0014 m³



LED COB CITIZEN / BRIDGELUX (DRIVER NOT INCLUDED)

POWER	BEAM	LUMEN	CCT	FINISH	CODE	€
5,5 W	30°	500 lm	3000 K	Dark Grey	248394	120
5,5 W	30°	600 lm	4000 K	Dark Grey	245041	120

0,280 Kg
0,0005 m³

OPTIONAL (NOT INCLUDED)

	POWER	FINISH	CODE	€
Visor	5,5 W	Dark Grey	245096	34
Visor	10 W	Dark Grey	245102	34
Peg		Dark Grey	245089	17

ON/OFF DRIVER (NOT INCLUDED/REQUIRED)

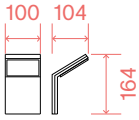
OUTPUT	POWER	MEASURE	CODE	€
24 Vdc	20 W	118 x 26 x 35 mm	226187	75
24 Vdc	40 W	148 x 30 x 40 mm	226194	80
24 Vdc	100 W	220 x 39 x 68 mm	226200	190
24 Vdc	185 W	220 x 39 x 68 mm	226217	210

STYLE

WALL



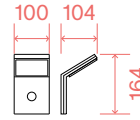
IP54



0,390 Kg
0,0018 m³
LED 8,5W
950/1050 lm

FINISH	CCT	CODE	€
White	3000 K	269139	135
White	4000 K	221502	135
Grey	3000 K	322650	135
Grey	4000 K	322643	135
Anthracite	3000 K	246857	135
Anthracite	4000 K	209845	135
Black	3000 K	322636	135
Black	4000 K	322629	135
Coffee	3000 K	322704	135
Coffee	4000 K	322681	135

LED source 3000/4000 K,
30.000 h life.



0,400 Kg
0,0018 m³
LED 9W
950/1050 lm

FINISH	CCT	CODE	€
White	3000 K	269146	165
White	4000 K	209852	165
Anthracite	3000 K	246864	165
Anthracite	4000 K	221519	165

LED source 3000/4000 K,
30.000 h life.

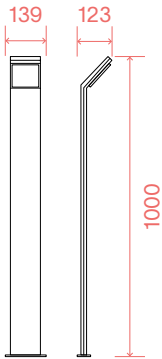


FLOOR



IP54

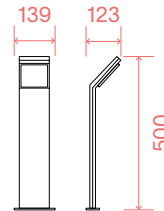
↑ PHOTO p. 442



1,680 Kg
0,0239 m³
LED 8,5W
950/1050 lm

FINISH	CCT	CODE	€
White	3000 K	318707	190
White	4000 K	322483	190
Grey	3000 K	322384	190
Grey	4000 K	322353	190
Anthracite	3000 K	246871	190
Anthracite	4000 K	209906	190
Black	3000 K	322230	190
Black	4000 K	322216	190
Coffee	3000 K	322452	190
Coffee	4000 K	322438	190

LED source 3000/4000 K,
30.000 h life.



1,020 Kg
0,0122 m³
LED 8,5W
950/1050 lm

FINISH	CCT	CODE	€
White	3000 K	318691	145
White	4000 K	322582	145
Grey	3000 K	322551	145
Grey	4000 K	322544	145
Anthracite	3000 K	322612	145
Anthracite	4000 K	322599	145
Black	3000 K	322537	145
Black	4000 K	322506	145
Coffee	3000 K	322575	145
Coffee	4000 K	322568	145

LED source 3000/4000 K,
30.000 h life.

SWIPE

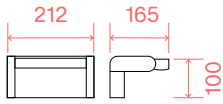
WALL



IP54



PHOTO p. 448

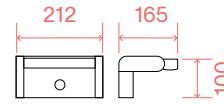


1,200 Kg
0,0055 m³
LED 20,5W / 2300 lm

FINISH	CODE	€
White	287690	120
Grey	326863	120
Anthracite	287683	120
Black	287706	120
Coffee	307169	120



LED source 3000 K,
50.000 h life.



1,300 Kg
0,0055 m³
LED 21W / 2300 lm

FINISH	CODE	€
White	287720	130
Grey	326870	130
Anthracite	287713	130
Black	287737	130
Coffee	307176	130



LED source 3000 K,
50.000 h life.



TAURUS ACCENT

RECESSED LIGHTS



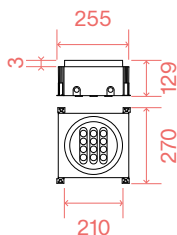
IP67

CRI: ≥90

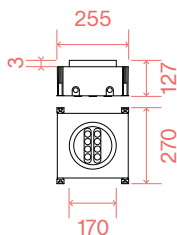
LED LIFE: 50.000 h



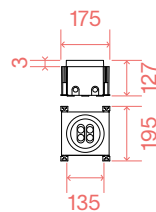
PHOTO p. 454



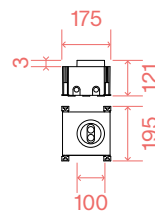
3,500 Kg
0,0242 m³



3,250 Kg
0,0133 m³



1,980 Kg
0,0071 m³



1,460 Kg
0,0129 m³

LED SMD OSRAM (DRIVER ON/OFF INCLUDED)

MEASURE	POWER	LUMEN	CCT	FINISH	CODE	€
ø 210	20 W	1800 lm	3000 K	Steel	277035	530
ø 170	12 W	1200 lm	3000 K	Steel	277028	405
ø 135	11 W	790 lm	3000 K	Steel	277011	320
ø 100	6 W	400 lm	3000 K	Steel	277004	210

TECHO

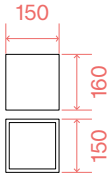
CEILING



IP54



PHOTO p. 460

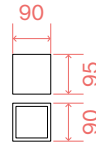


1,700 Kg
0,0049 m³
GU10 max 1 x 20W

(RECOMMENDED)

LUMEN	CCT	CODE	€
780 lm	4000 K	253398	15

FINISH	CODE	€
White	251523	115
Grey	326887	115
Anthracite	251516	115
Black	251530	115
Coffee	251547	115

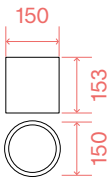


0,600 Kg
0,0012 m³
GU10 max 1 x 20W

(RECOMMENDED)

LUMEN	CCT	CODE	€
430 lm	4000 K	253497	3

FINISH	CODE	€
White	251561	64
Grey	326894	64
Anthracite	251554	64
Black	251578	64
Coffee	251592	64

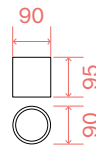


1,500 Kg
0,0052 m³
GU10 max 1 x 20W

(RECOMMENDED)

LUMEN	CCT	CODE	€
780 lm	4000 K	253398	15

FINISH	CODE	€
White	342689	115
Grey	342702	115
Anthracite	318103	115
Black	342719	115
Coffee	342696	115



0,550 Kg
0,0015 m³
GU10 max 1 x 20W

(RECOMMENDED)

LUMEN	CCT	CODE	€
430 lm	4000 K	253497	3

FINISH	CODE	€
White	318127	64
Grey	342726	64
Anthracite	318110	64
Black	318141	64
Coffee	318134	64

TESLA

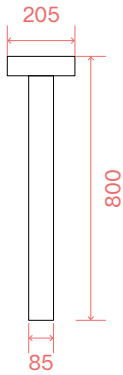
FLOOR



IP44



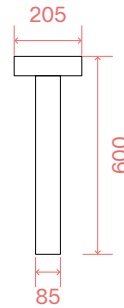
PHOTO p. 466



(RECOMMENDED)

LUMEN	CCT	CODE	€
530 lm	4000 K	307879	6
FINISH		CODE	€
White		153179	155
Anthracite		153162	155
Black		316055	155
Coffee		326924	155

3,000 Kg
0,0379 m³
G9 max 4 x 15W



(RECOMMENDED)

LUMEN	CCT	CODE	€
530 lm	4000 K	307879	6
FINISH		CODE	€
White		153209	145
Anthracite		153193	145
Black		326917	145
Coffee		316048	145

2,560 Kg
0,0273 m³
G9 max 4 x 15W

VEGA

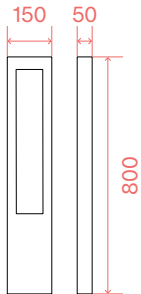
FLOOR



IP44



PHOTO p. 472



(RECOMMENDED)

LUMEN	CCT	CODE	€
530 lm	4000 K	307879	6
FINISH		CODE	€
White		136035	180
Grey		136042	180
Anthracite		136028	180
Black		136059	180
Coffee		213361	180

1,150 Kg
0,0092 m³
G9 max 1 x 15W

Technical icons



Class I Electrical safety guaranteed by main insulation and additional protective conductor (earthing) connected with metal lamp frame. Earthing is obligatory.



Class III Electrical safety guaranteed by very low power supply (less than 50 Volt). Earthing excluded.



Class II Electrical safety guaranteed by main insulation and double or reinforced insulation. Earthing not necessary.



Mark of conformity to European Community Safety regulations.

Symbols



Items with LED lights: very low consumption, highly bright and focused light, strength and durability.



Luminaire with dimmer.



Integrated switch button.



Lamp with integrated USB socket.



Lamp with touch switch: switching on and dimming by touching the base with a finger.



Lamp with rechargeable battery included.



Lampada con rilevazione di presenza inclusa PIR (Passive InfraRed).



Item made of stainless steel 316.



High-tech product with high quality materials, intended for professional use.

NOTES::

-The indicated prices are public prices VAT excluded.

-Ideal lux s.r.l. reserves the right to make, at any time and without notice, all the changes necessary to improve the quality of the items included in this catalogue. For the most updated features, please check the documentation available on our website (www.ideal-lux.com).

-Our products with Class I and II work with nominal Voltage of 220-240 Vac 50/60 Hz. All our products comply with EU legislation.

-Whenever purchased separately as "optional", the DIMMABLE DRIVER will be already included in the product as replacement for the default on-off driver: only one driver will be supplied.

-The Watt indicated in the catalogue express the NOMINAL power of the lighting fitting including

source and driver, when present. The Lumen measures referred to the lighting fittings with integrated LED source are nominal, namely referred to the source.

We kindly invite you to check photometry files for the actual Lumen of the single lighting fittings. For further information and updates.

-The UGR rate is not a characteristic of the fitting itself, but of the installation. The UGR values reported in this catalogue are calculated taking into consideration an ideal installation and are regrouped into blocks <10 <13 <16 <19 <22. It is recommended to calculate the specific UGR according to your installation.

-The useful life of the LED sources of all the products in the catalogue refers, when it is not differently declared, to the L70B50 value.

Agos, Andromeda, Atom, Bean, Binomio, Birds, Clip, Cover,
Delta, Deva, Diesis, Display, Dorsale, Dynamite, Ego, Eos,
Equinoxe, Essence, Filo, Fluo, Fly, Focus, Fox, Frame, Futura,
Game, Gemini, Gun, Jedi, Lika, Linea, Link, Linus, Lolita, Look,
Mapa, Mint, Mix Up, Moby, Nemo, Ninfea, Nitro, Nova, Oracle Slim,
Oz, Perlage, Piano, Punto, Pure, Quick, Set Up, Sirio, Smarties,
Sole, Spike, Starlight, Style, Swipe, Taurus, Techo, Tesi, Tesla,
Ultrathin, Vega, Virus, Zeus, Zig Zag.