



■ Features

- Constant Power mode output
- Metal housing design
- Full Power at 70~100% max Current
- Built-in active PFC function
- Flicker Free design
- No load / Standby power consumption <0.5W
- Output current level pre-settable
- Function options: 3 in 1 dimming (dim-to-off); DALI interface, push dimming
- Typical lifetime>50000 hours
- SELV and Isolated
- Class 2 power supply
- 5 years warranty

■ Applications

- LED panel lighting
- Indoor LED lighting
- Linear LED lighting

■ Description

LDC-35 series is a 35W AC/DC LED driver featuring the constant power mode output. LDC-35 operates from 180~295VAC and output current can be adjust between 300mA to 1000mA. Thanks to the efficiency up to 88%, with the fanless design, the entire series is able to operate for -25°C~+80°C case temperature under free air convection. LDC-35 is equipped with various function options, such as dimming methodologies, so as to provide the optimal design flexibility for LED lighting system.

■ Model Encoding

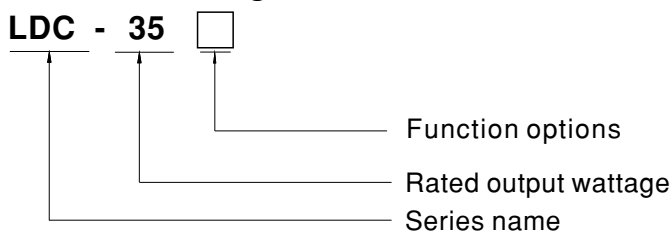

Type	Function	Note
Blank	Non dimming	In Stock
B	3 in 1 dimming function (0~10Vdc and 10V PWM signal and resistance)	In Stock
DA	DALI, push dimming	In Stock



SPECIFICATION

MODEL		LDC-35□
OUTPUT	OUTPUT CURRENT REGION	300 ~ 1000mA(300mA default)
	RATED POWER <small>Note.2</small>	35W
	CONSTANT CURRENT REGION <small>Note.2</small>	27 ~ 56V
	FULL POWER CURRENT RANGE	625 ~ 1000mA
	OPEN CIRCUIT VOLTAGE <small>(max.)</small>	60V
	LOW FREQUENCY CURRENT RIPPLE	3.0% max. @rated current
	CURRENT TOLERANCE	±5.0%
	SET UP TIME <small>Note.4</small>	500ms/230VAC
INPUT	VOLTAGE RANGE <small>Note.3</small>	180 ~ 295VAC (Please refer to "STATIC CHARACTERISTIC" section)
	FREQUENCY RANGE	47 ~ 63Hz
	POWER FACTOR <small>(Typ.)</small>	PF ≥ 0.95/230VAC@load ≥ 50%; PF ≥ 0.92/277VAC@load ≥ 75% (Please refer to "POWER FACTOR (PF) CHARACTERISTIC" section)
	TOTAL HARMONIC DISTORTION	THD < 10%(@load ≥ 50%/230VAC; @load ≥ 75%/277VAC) (Please refer to "TOTAL HARMONIC DISTORTION(THD)" section)
	EFFICIENCY <small>(Typ.)</small>	88%(230VAC@Full load)
	AC CURRENT <small>(Typ.)</small>	0.2A / 230VAC 0.16A / 277VAC
	INRUSH CURRENT <small>(Typ.)</small>	COLD START 30A(twidth=250μs measured at 50% Ipeak)/230VAC; Per NEMA 410
	MAX. No. of PSUs on 16A CIRCUIT BREAKER	17 units (circuit breaker of type B) / 29 units (circuit breaker of type C) at 230VAC
	LEAKAGE CURRENT	<0.75mA / 277VAC
PROTECTION	SHORT CIRCUIT	Hiccup mode or constant current limiting ,recovers automatically after fault condition is removed
	OVER VOLTAGE	61 ~ 80V Shut down o/p voltage with auto-recovery or re-power on to recovery
	OVER TEMPERATURE	Shut down o/p voltage, with auto-recovery
FUNCTION	DIMMING	Please refer to"DIMMING OPERATION"section
	TEMP. COMPENSATION	By external NTC, please refer to"TEMPERATURE COMPENSATION OPERATION"section
ENVIRONMENT	WORKING TEMP.	Tcase=-25 ~ +80°C (Please refer to " OUTPUT LOAD vs TEMPERATURE" section)
	MAX. CASE TEMP.	Tcase=+80°C
	WORKING HUMIDITY	20 ~ 95% RH non-condensing
	STORAGE TEMP., HUMIDITY	-40 ~ +80°C, 10 ~ 95% RH
	TEMP. COEFFICIENT	±0.03%/°C (0 ~ 60°C)
	VIBRATION	10 ~ 500Hz, 2G 10min./1cycle, period for 60min. each along X, Y, Z axes
SAFETY & EMC	SAFETY STANDARDS <small>Note.5</small>	UL8750, CSA C22.2 No. 250.13-12; IEC 61140, EN61140-1, EN61140-2, AS/NZS 61347.1:2016, AS/NZS IEC 61347.2.13:2013; EN62384; GB19510.14,GB19510.1, EAC TP TC 004 approved
	DALI STANDARDS	Compliance to IEC62386-101.102.207 for DA-Type only
	WITHSTAND VOLTAGE	I/P-O/P:3.75KVAC I/P-FG:2.0KVAC O/P-FG:1.5KVAC
	ISOLATION RESISTANCE	I/P-O/P, I/P-FG, O/P-FG:100M Ohms / 500VDC / 25°C / 70% RH
	EMC EMISSION <small>Note.5</small>	Compliance to EN55015,EN61000-3-2 Class C (@load ≥ 50%) ; EN61000-3-3:GB/T17743,GB17625.1,EAC TP TC 020
	EMC IMMUNITY	Compliance to EN61000-4-2,3,4,5,6,8,11; EN61547, light industry level(surge immunity:Line-Earth:2KV,Line-Line:1KV) criteria A,EAC TP TC 020
OTHERS	MTBF	1097K hrs min. Telcordia SR-332 (Bellcore) 286Khrs min. MIL-HDBK-217F (25°C)
	DIMENSION	280*30*21mm (L*W*H)
	PACKING	0.22Kg; 54pcs/12.88Kg/0.91CUFT
NOTE	<ol style="list-style-type: none"> All parameters NOT specially mentioned are measured at 230VAC input, rated current and 25°C of ambient temperature. Please refer to " OUTPUT CURRENT SETTING ". De-rating may be needed under low input voltages. Please refer to "STATIC CHARACTERISTIC" sections for details. Length of set up time is measured at first cold start. Turning ON/OFF the power supply may lead to increase of the set up time. The driver is considered as a component that will be operated in combination with final equipment. Since EMC performance will be affected by the complete installation, the final equipment manufacturers must re-qualify EMC Directive on the complete installation again. This series meets the typical life expectancy of >50000 hours of operation when Tcase, particularly T_c point (or TMP, per DLC), is about 70°C or less. Please refer to the warranty statement on MEAN WELL's website at http://www.meanwell.com The ambient temperature derating of 3.5°C/1000m with fanless models and of 5°C/1000m with fan models for operating altitude higher than 2000m(6500ft). 	

■ BLOCK DIAGRAM

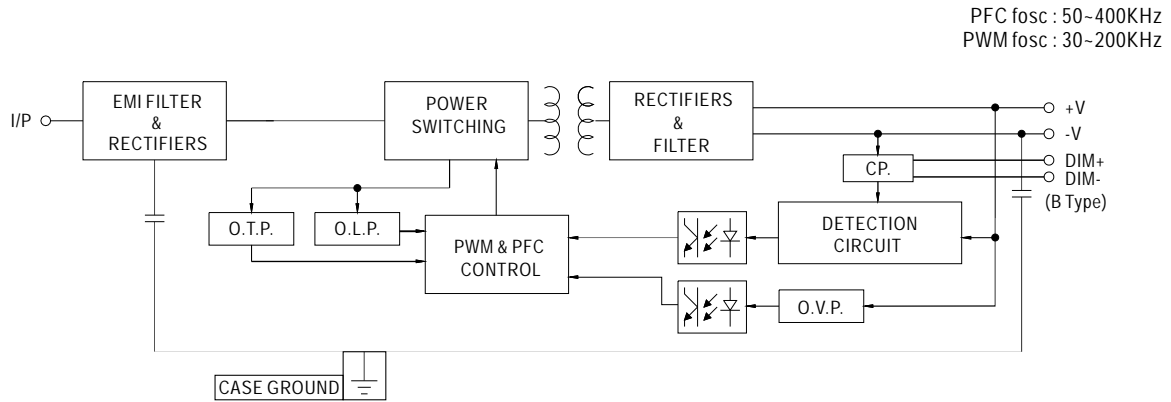

■ OUTPUT CURRENT SETTING

◎I-V Operating Area.

Output rated current level can be adjusted by a additive resistance.

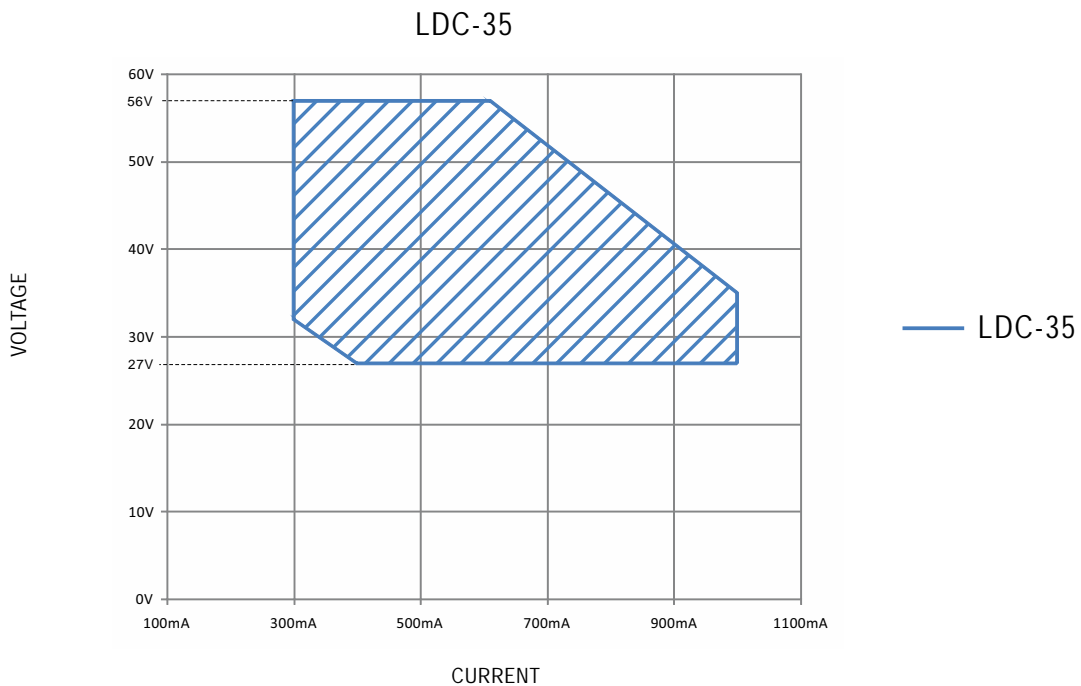

◎ Rated current setting table

15.2K	19K	24.5K	32.5K	43K	46K	72.5K	100K	150K	300K	NC
1A	0.9A	0.8A	0.7A	0.62A	0.6A	0.5A	0.45A	0.4A	0.35A	0.3A

Note: output power \leq 35W

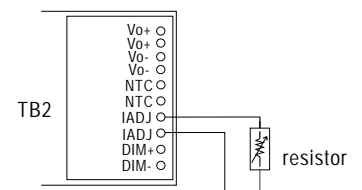

■ DIMMING OPERATION



※ 3 in 1 dimming function(for B-Type)

- Output constant current level can be adjusted by applying one of the three methodologies between DIM+ and DIM-: 0 - 10VDC, or 10V PWM signal or resistance.
- Direct connecting to LEDs is suggested. It is not suitable to be used with additional drivers.
- Dimming source current from power supply: 100 μ A (typ.)

◎ Applying additive 0 - 10VDC

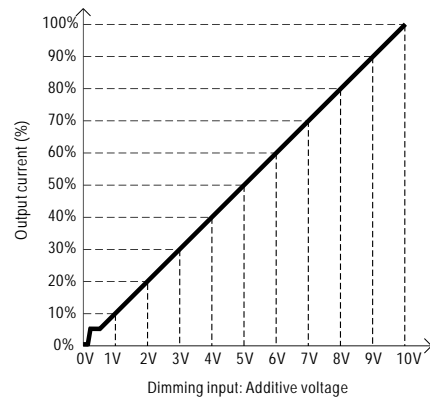
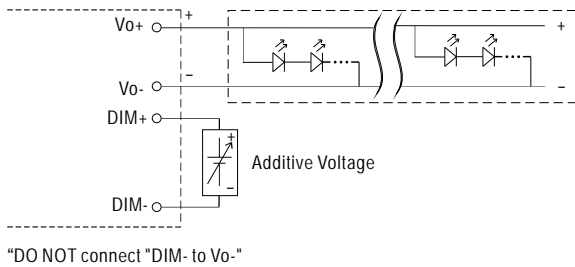

◎ Applying additive 10V PWM signal (frequency range 100Hz ~ 3KHz):

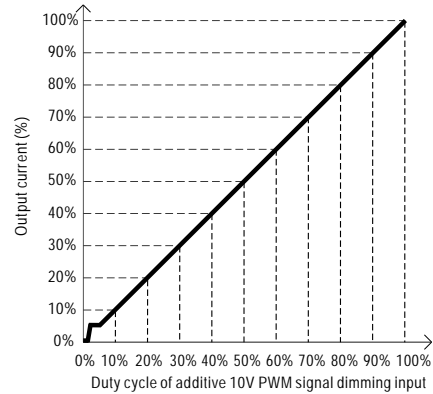
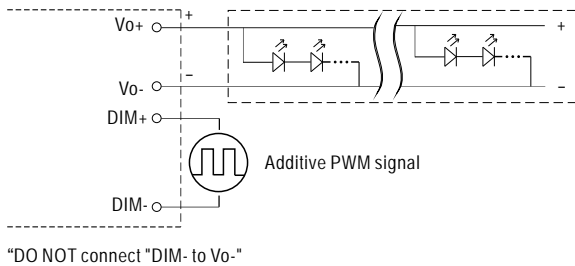

◎ Applying additive resistance:

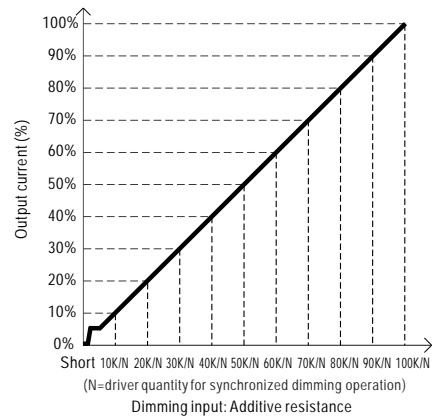
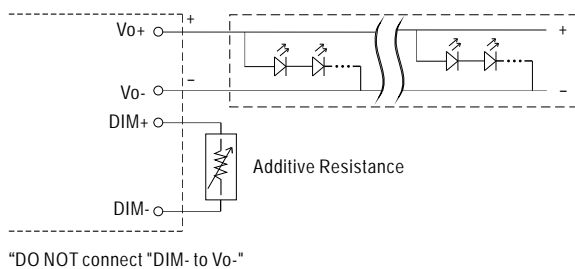

- Note :
1. Min. dimming level is about 8% and the output current is not defined when $0\% < I_{out} < 8\%$.
 2. The output current could drop down to 0% when dimming input is about 0Vdc or 10V PWM signal with 0% duty cycle.
 3. To ensure the dimming performance at low dimming level, output current must be over 45mA.

※DALI interface



◎ PUSH dimming(primary side)

Action	Action duration	Function
Short push	0.1~1 sec.	Turn ON-OFF the driver
Long push	1.5~10 sec.	Every Long Push changes the dimming direction, dimming up or down
Reset	>11 sec.	Set up the dimming level to 100%

- The factory default dimming level is at 100%.
- If the push action lasts less than 0.05 sec., it will not lead to a change for the status of the driver.
- Up to 10 drivers can perform the PUSH dimming at the same time when utilizing one common push button.
- The maximum length of the cable from the push button to the last driver is 20 meters.
- The additive push button can be connected only between the LS terminal, as displayed in the diagram, and AC/L (in brown or black); it will lead to short circuit if it is connected to AC/N.

◎ DALI interface(primary side)

- Apply DALI signal between DA+ and DA-
- DALI protocol comprises 16 groups and 64 addresses.
- First step is fixed at 8% of rated output power.

NOTE: DALI, Push dimming can not be used in the same time!(The factory setting defaults to DA)

■ TEMPERATURE COMPENSATION OPERATION

LDC-35 have the built-in temperature compensation function ; by connecting a temperature sensor (NTC resistor) between the +NTC / -NTC terminal of LDC-35 and the detecting point on the lighting system or the surrounding environment, output current of LDC-35 could be correspondingly changed, based on the sensed temperature, to ensure the long life of LED.

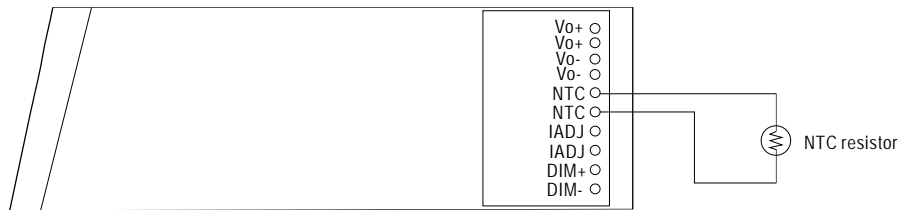

- ◎ LDC-35 can still be operated normally when the NTC resistor is not connected and the value of output current will be the current level selected through the IADJ. pin
- ◎ NTC reference:

NTC resistance	Output Current
<20K	Output current reduce as the resistance decreases
>20K	Normal output current

Notes: 1. MEAN WELL does not offer the NTC resistor and all the data above are measured by using resistor.
 2. If new brand of NTC resistor is applied, please check the temperature curve first.

- ◎ Dimming function of the driver will be invalid when the "temperature compensation" function is in use.

■ OUTPUT LOAD vs TEMPERATURE

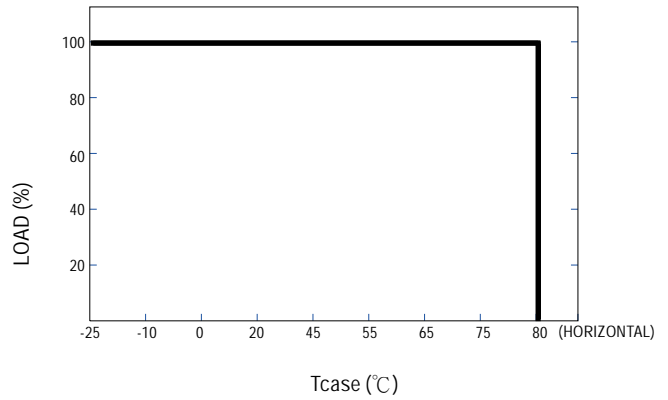
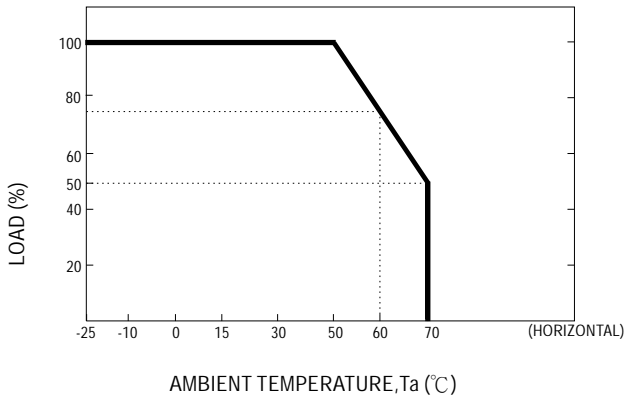

■ STATIC CHARACTERISTIC

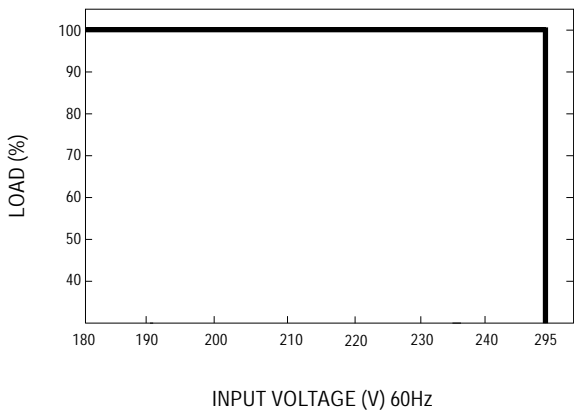

■ POWER FACTOR (PF) CHARACTERISTIC

※ Tcase at 75°C

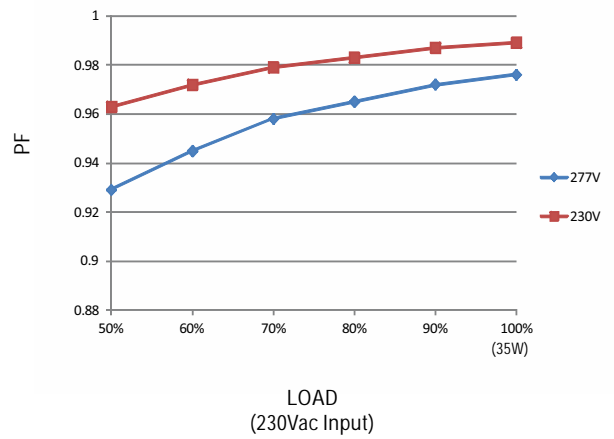

■ TOTAL HARMONIC DISTORTION (THD)

※ 1000mA Model, Tcase at 75°C

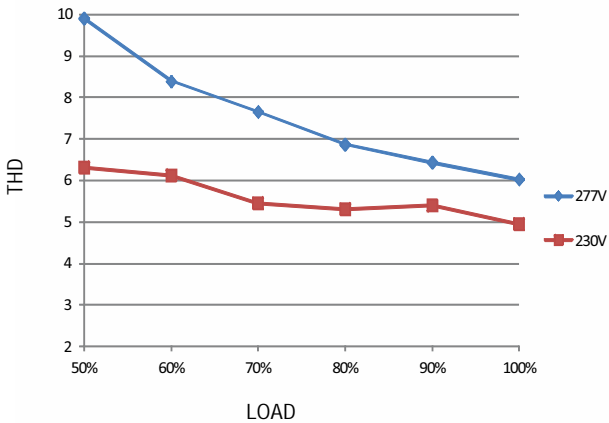

■ EFFICIENCY vs LOAD

LDC-35 series possess superior working efficiency up to 90%.

※ 1000mA Model, Tcase at 75°C

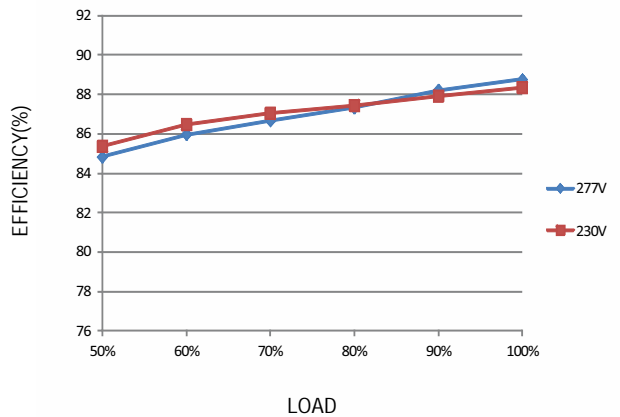

■ LIFE TIME

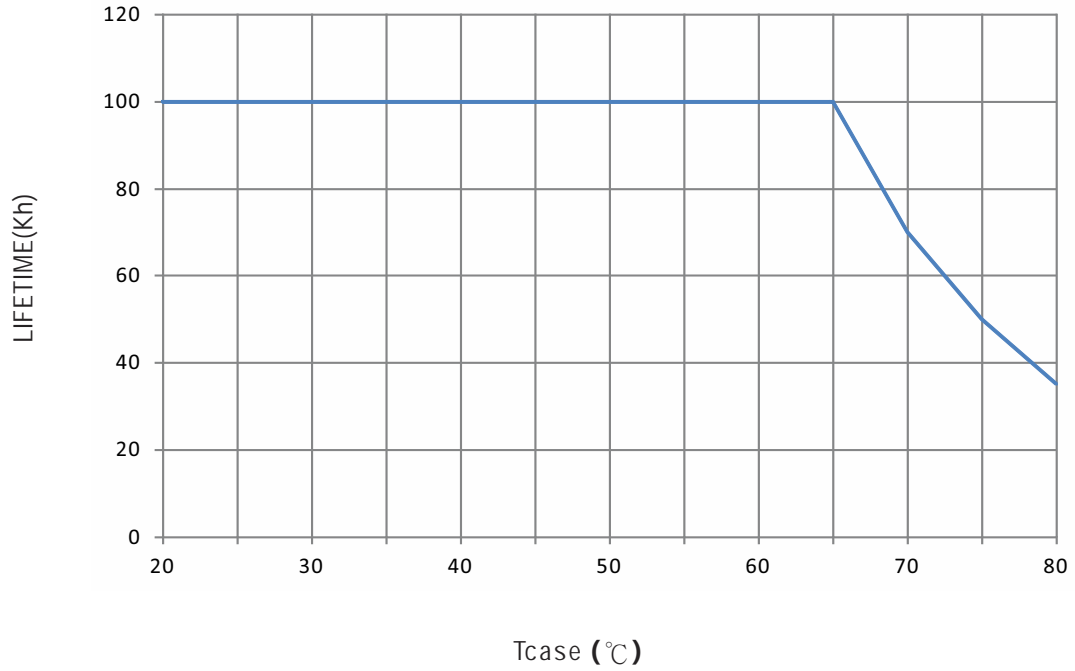

MECHANICAL SPECIFICATION

CASE NO.: 263A Unit:mm

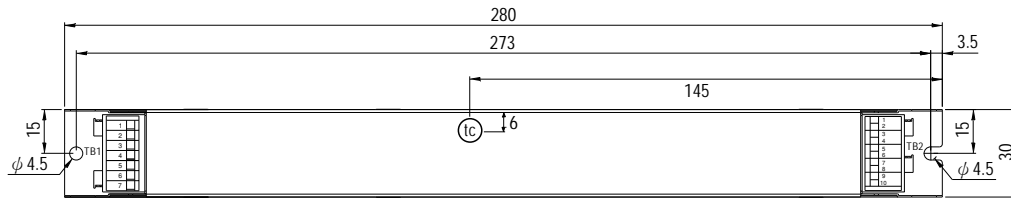

• (tc) : Max. Case Temperature

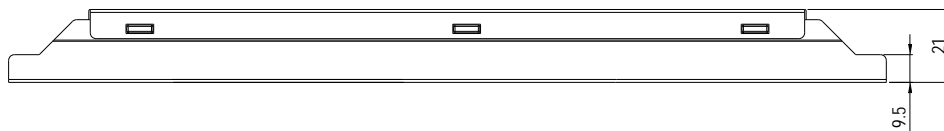

Terminal Pin No. Assignment (TB1) :

Pin No.	Assignment
1	ACL
2	ACN
3	NC
4	FG
5	NC(for DA-type only)
6	DA-/N(for DA-type only)
7	DA+/Ls(for DA-type only)

Terminal Pin No. Assignment (TB2) :

Pin No.	Assignment
1	Vo+
2	Vo+
3	Vo-
4	Vo-
5	NTC
6	NTC
7	IADJ
8	IADJ
9	DIM+(for B-type only)
10	DIM-(for B-type only)

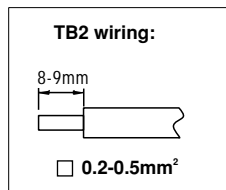
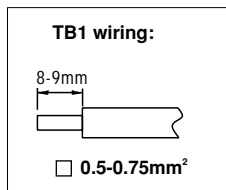
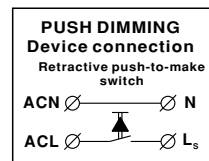

Installation Manual

Please refer to : <http://www.meanwell.com/manual.html>



■ Features

- Constant Power mode output
- Metal housing design
- Full Power at 70~100% max Current
- Built-in active PFC function
- Flicker Free design
- No load / Standby power consumption <0.5W
- Output current level pre-settable
- Function options: 3 in 1 dimming (dim-to-off); DALI interface, push dimming
- Typical lifetime>50000 hours
- SELV and Isolated
- Class 2 power supply
- 5 years warranty

■ Applications

- LED panel lighting
- Indoor LED lighting
- Linear LED lighting

■ Description

LDC-35 series is a 35W AC/DC LED driver featuring the constant power mode output. LDC-35 operates from 180~295VAC and output current can be adjust between 300mA to 1000mA. Thanks to the efficiency up to 88%, with the fanless design, the entire series is able to operate for -25°C~+80°C case temperature under free air convection. LDC-35 is equipped with various function options, such as dimming methodologies, so as to provide the optimal design flexibility for LED lighting system.

■ Model Encoding

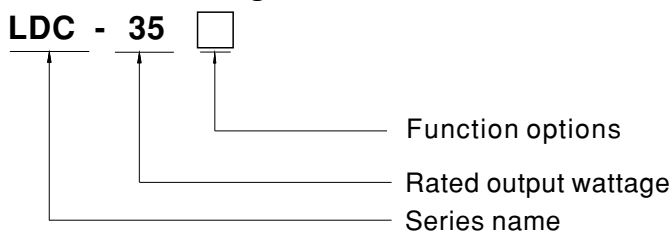

Type	Function	Note
Blank	Non dimming	In Stock
B	3 in 1 dimming function (0~10Vdc and 10V PWM signal and resistance)	In Stock
DA	DALI, push dimming	In Stock



SPECIFICATION

MODEL		LDC-35□
OUTPUT	OUTPUT CURRENT REGION	300 ~ 1000mA(300mA default)
	RATED POWER <small>Note.2</small>	35W
	CONSTANT CURRENT REGION <small>Note.2</small>	27 ~ 56V
	FULL POWER CURRENT RANGE	625 ~ 1000mA
	OPEN CIRCUIT VOLTAGE <small>(max.)</small>	60V
	LOW FREQUENCY CURRENT RIPPLE	3.0% max. @rated current
	CURRENT TOLERANCE	±5.0%
	SET UP TIME <small>Note.4</small>	500ms/230VAC
INPUT	VOLTAGE RANGE <small>Note.3</small>	180 ~ 295VAC (Please refer to "STATIC CHARACTERISTIC" section)
	FREQUENCY RANGE	47 ~ 63Hz
	POWER FACTOR <small>(Typ.)</small>	PF ≥ 0.95/230VAC@load ≥ 50%; PF ≥ 0.92/277VAC@load ≥ 75% (Please refer to "POWER FACTOR (PF) CHARACTERISTIC" section)
	TOTAL HARMONIC DISTORTION	THD < 10%(@load ≥ 50%/230VAC; @load ≥ 75%/277VAC) (Please refer to "TOTAL HARMONIC DISTORTION(THD)" section)
	EFFICIENCY <small>(Typ.)</small>	88%(230VAC@Full load)
	AC CURRENT <small>(Typ.)</small>	0.2A / 230VAC 0.16A / 277VAC
	INRUSH CURRENT <small>(Typ.)</small>	COLD START 30A(twidth=250μs measured at 50% Ipeak)/230VAC; Per NEMA 410
	MAX. No. of PSUs on 16A CIRCUIT BREAKER	17 units (circuit breaker of type B) / 29 units (circuit breaker of type C) at 230VAC
	LEAKAGE CURRENT	<0.75mA / 277VAC
PROTECTION	SHORT CIRCUIT	Hiccup mode or constant current limiting ,recovers automatically after fault condition is removed
	OVER VOLTAGE	61 ~ 80V Shut down o/p voltage with auto-recovery or re-power on to recovery
	OVER TEMPERATURE	Shut down o/p voltage, with auto-recovery
FUNCTION	DIMMING	Please refer to"DIMMING OPERATION"section
	TEMP. COMPENSATION	By external NTC, please refer to"TEMPERATURE COMPENSATION OPERATION"section
ENVIRONMENT	WORKING TEMP.	Tcase=-25 ~ +80°C (Please refer to " OUTPUT LOAD vs TEMPERATURE" section)
	MAX. CASE TEMP.	Tcase=+80°C
	WORKING HUMIDITY	20 ~ 95% RH non-condensing
	STORAGE TEMP., HUMIDITY	-40 ~ +80°C, 10 ~ 95% RH
	TEMP. COEFFICIENT	±0.03%/°C (0 ~ 60°C)
	VIBRATION	10 ~ 500Hz, 2G 10min./1cycle, period for 60min. each along X, Y, Z axes
SAFETY & EMC	SAFETY STANDARDS <small>Note.5</small>	UL8750, CSA C22.2 No. 250.13-12; IEC 61140-1, EN61347-1, EN61347-2-13, AS/NZS 61347.1:2016, AS/NZS IEC 61347.2.13:2013; EN62384; GB19510.14,GB19510.1, EAC TP TC 004 approved
	DALI STANDARDS	Compliance to IEC62386-101.102.207 for DA-Type only
	WITHSTAND VOLTAGE	I/P-O/P:3.75KVAC I/P-FG:2.0KVAC O/P-FG:1.5KVAC
	ISOLATION RESISTANCE	I/P-O/P, I/P-FG, O/P-FG:100M Ohms / 500VDC / 25°C / 70% RH
	EMC EMISSION <small>Note.5</small>	Compliance to EN55015,EN61000-3-2 Class C (@load ≥ 50%) ; EN61000-3-3:GB/T17743,GB17625.1,EAC TP TC 020
	EMC IMMUNITY	Compliance to EN61000-4-2,3,4,5,6,8,11; EN61547, light industry level(surge immunity:Line-Earth:2KV,Line-Line:1KV) criteria A,EAC TP TC 020
OTHERS	MTBF	1097K hrs min. Telcordia SR-332 (Bellcore) 286Khrs min. MIL-HDBK-217F (25°C)
	DIMENSION	280*30*21mm (L*W*H)
	PACKING	0.22Kg; 54pcs/12.88Kg/0.91CUFT
NOTE	<ol style="list-style-type: none"> All parameters NOT specially mentioned are measured at 230VAC input, rated current and 25°C of ambient temperature. Please refer to " OUTPUT CURRENT SETTING ". De-rating may be needed under low input voltages. Please refer to "STATIC CHARACTERISTIC" sections for details. Length of set up time is measured at first cold start. Turning ON/OFF the power supply may lead to increase of the set up time. The driver is considered as a component that will be operated in combination with final equipment. Since EMC performance will be affected by the complete installation, the final equipment manufacturers must re-qualify EMC Directive on the complete installation again. This series meets the typical life expectancy of >50000 hours of operation when Tcase, particularly T_c point (or TMP, per DLC), is about 70°C or less. Please refer to the warranty statement on MEAN WELL's website at http://www.meanwell.com The ambient temperature derating of 3.5°C/1000m with fanless models and of 5°C/1000m with fan models for operating altitude higher than 2000m(6500ft). 	

■ BLOCK DIAGRAM

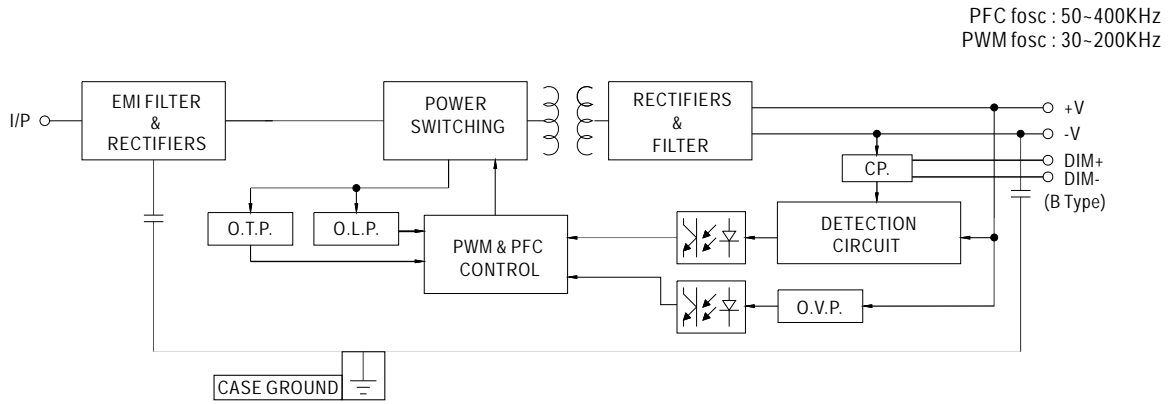

■ OUTPUT CURRENT SETTING

◎I-V Operating Area.

Output rated current level can be adjusted by a additive resistance.

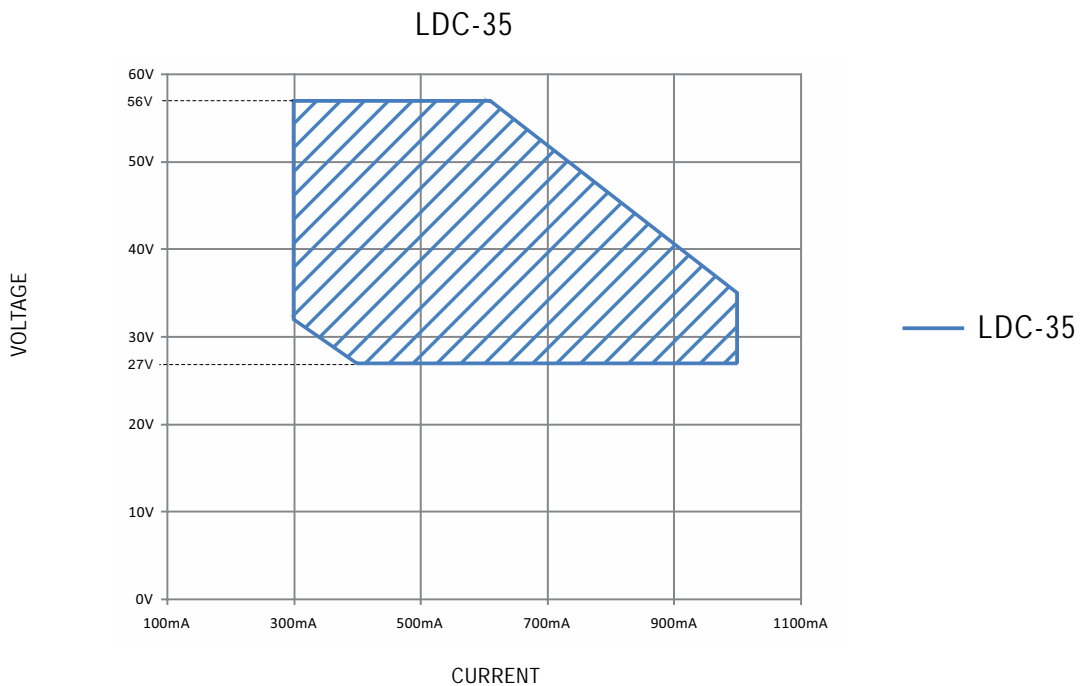

◎ Rated current setting table

15.2K	19K	24.5K	32.5K	43K	46K	72.5K	100K	150K	300K	NC
1A	0.9A	0.8A	0.7A	0.62A	0.6A	0.5A	0.45A	0.4A	0.35A	0.3A

Note: output power \leq 35W

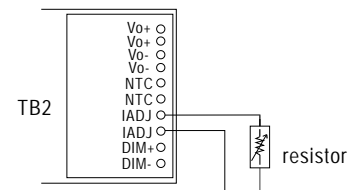

■ DIMMING OPERATION



※ 3 in 1 dimming function(for B-Type)

- Output constant current level can be adjusted by applying one of the three methodologies between DIM+ and DIM-: 0 - 10VDC, or 10V PWM signal or resistance.
- Direct connecting to LEDs is suggested. It is not suitable to be used with additional drivers.
- Dimming source current from power supply: 100 μ A (typ.)

◎ Applying additive 0 - 10VDC

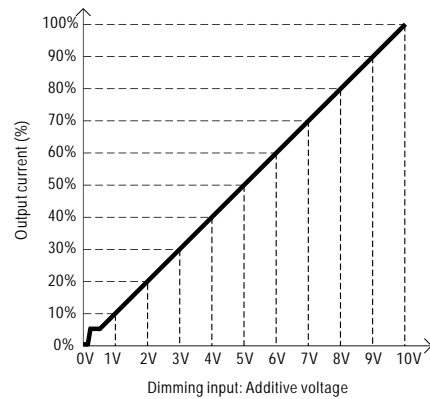
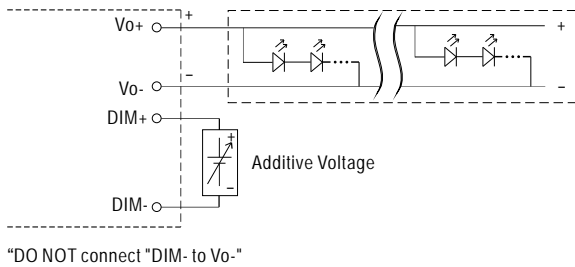

◎ Applying additive 10V PWM signal (frequency range 100Hz ~ 3KHz):

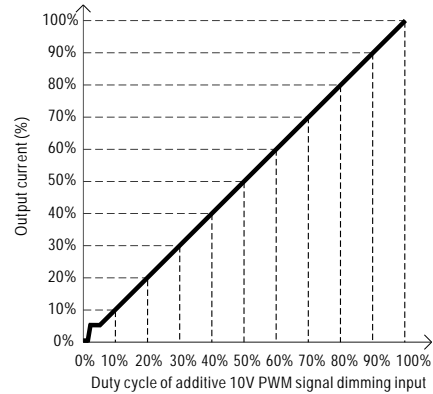
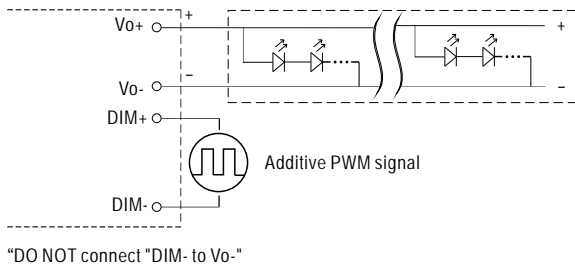

◎ Applying additive resistance:

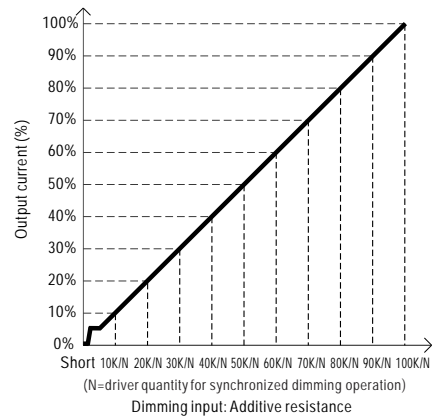
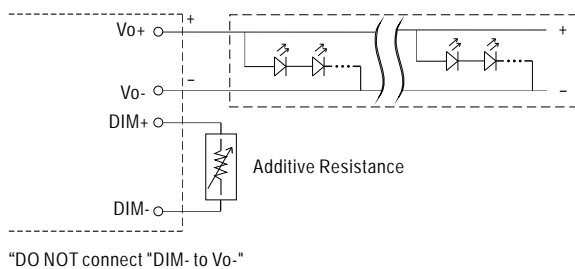

- Note :
1. Min. dimming level is about 8% and the output current is not defined when $0\% < I_{out} < 8\%$.
 2. The output current could drop down to 0% when dimming input is about 0Vdc or 10V PWM signal with 0% duty cycle.
 3. To ensure the dimming performance at low dimming level, output current must be over 45mA.

※DALI interface



◎ PUSH dimming(primary side)

Action	Action duration	Function
Short push	0.1~1 sec.	Turn ON-OFF the driver
Long push	1.5~10 sec.	Every Long Push changes the dimming direction, dimming up or down
Reset	>11 sec.	Set up the dimming level to 100%

- The factory default dimming level is at 100%.
- If the push action lasts less than 0.05 sec., it will not lead to a change for the status of the driver.
- Up to 10 drivers can perform the PUSH dimming at the same time when utilizing one common push button.
- The maximum length of the cable from the push button to the last driver is 20 meters.
- The additive push button can be connected only between the LS terminal, as displayed in the diagram, and AC/L (in brown or black); it will lead to short circuit if it is connected to AC/N.

◎ DALI interface(primary side)

- Apply DALI signal between DA+ and DA-
- DALI protocol comprises 16 groups and 64 addresses.
- First step is fixed at 8% of rated output power.

NOTE: DALI, Push dimming can not be used in the same time!(The factory setting defaults to DA)

■ TEMPERATURE COMPENSATION OPERATION

LDC-35 have the built-in temperature compensation function ; by connecting a temperature sensor (NTC resistor) between the +NTC / -NTC terminal of LDC-35 and the detecting point on the lighting system or the surrounding environment, output current of LDC-35 could be correspondingly changed, based on the sensed temperature, to ensure the long life of LED.

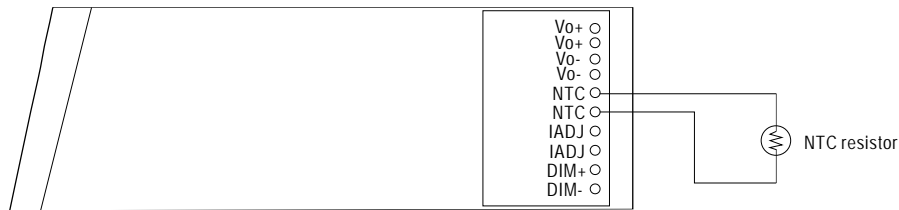

◎ LDC-35 can still be operated normally when the NTC resistor is not connected and the value of output current will be the current level selected through the IADJ. pin

◎ NTC reference:

NTC resistance	Output Current
<20K	Output current reduce as the resistance decreases
>20K	Normal output current

Notes: 1. MEAN WELL does not offer the NTC resistor and all the data above are measured by using resistor.
 2. If new brand of NTC resistor is applied, please check the temperature curve first.

◎ Dimming function of the driver will be invalid when the "temperature compensation" function is in use.

■ OUTPUT LOAD vs TEMPERATURE

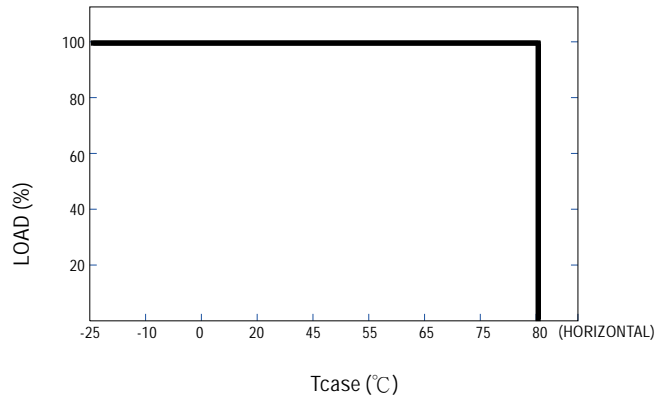
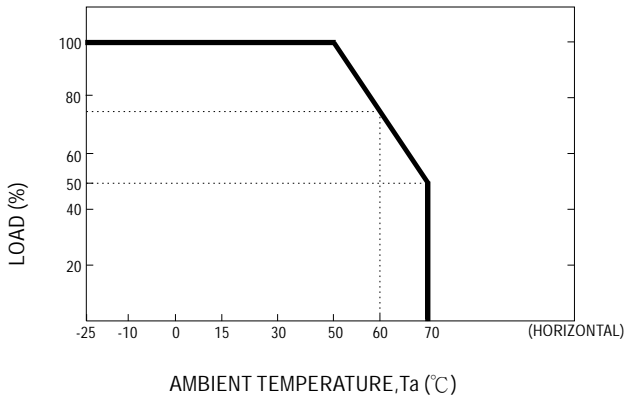

■ STATIC CHARACTERISTIC

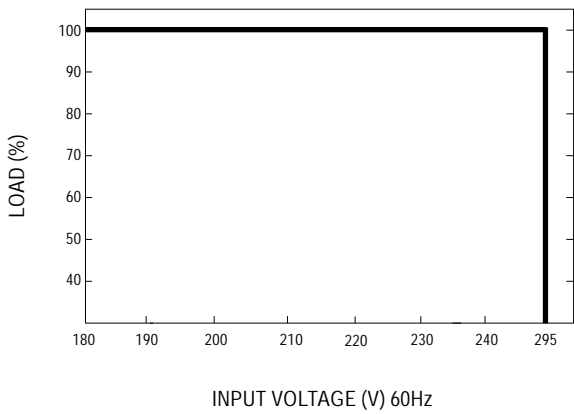

■ POWER FACTOR (PF) CHARACTERISTIC

※ Tcase at 75°C

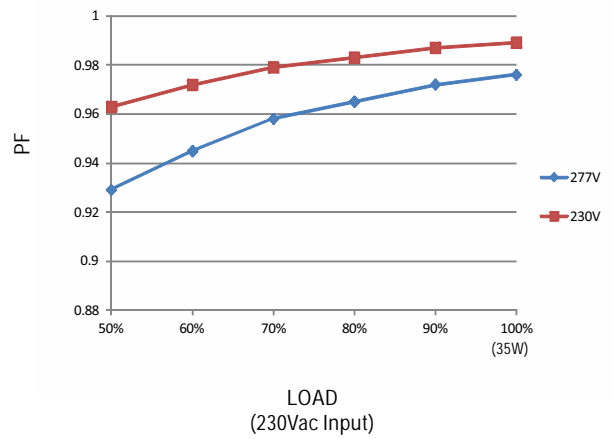

■ TOTAL HARMONIC DISTORTION (THD)

※ 1000mA Model, Tcase at 75°C

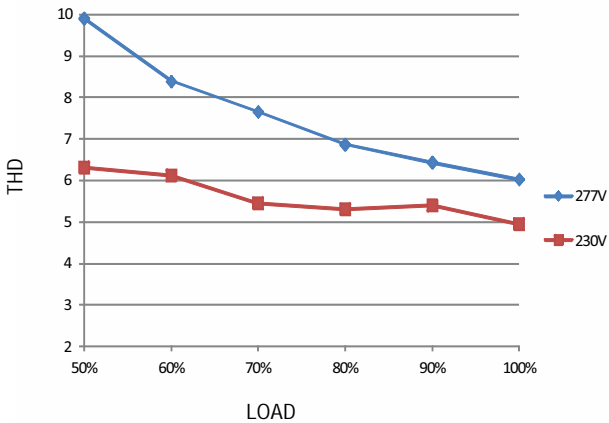

■ EFFICIENCY vs LOAD

LDC-35 series possess superior working efficiency up to 90%.

※ 1000mA Model, Tcase at 75°C

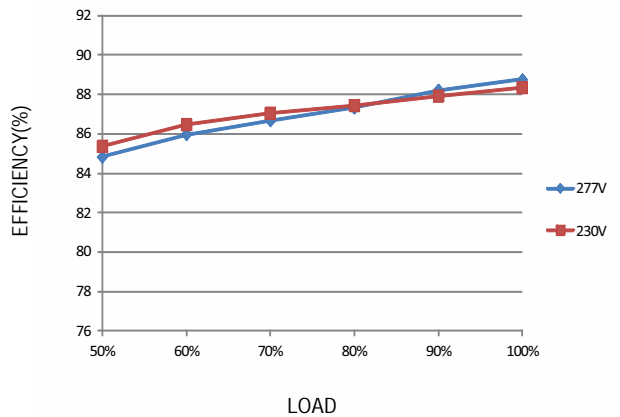

■ LIFE TIME

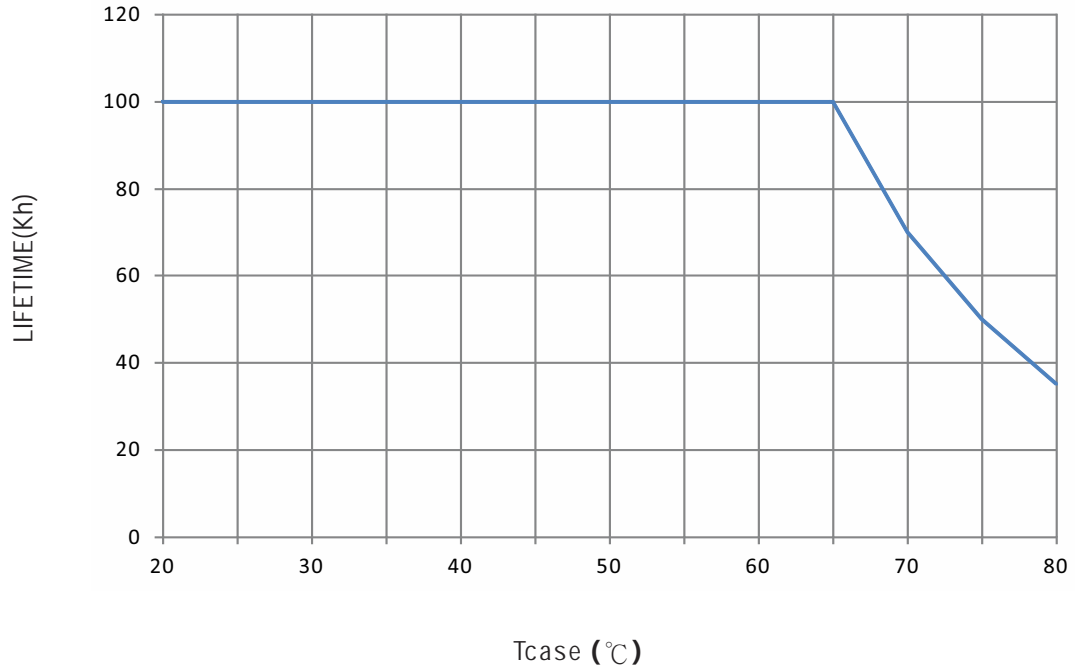

MECHANICAL SPECIFICATION

CASE NO.: 263A Unit:mm

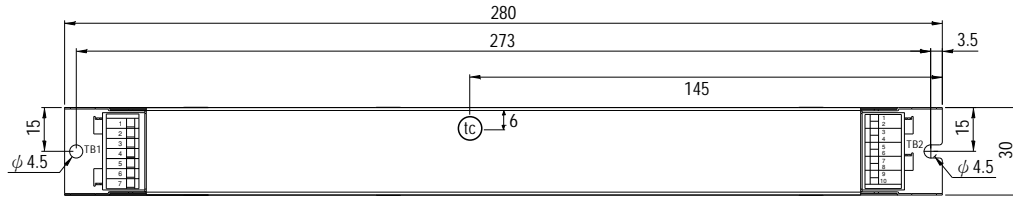

• (tc) : Max. Case Temperature

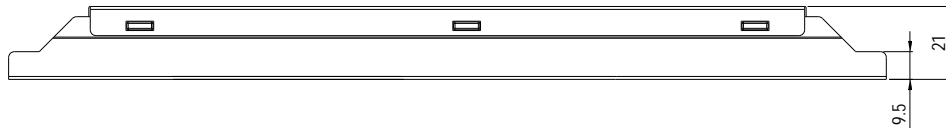

Terminal Pin No. Assignment (TB1) :

Pin No.	Assignment
1	ACL
2	ACN
3	NC
4	FG
5	NC(for DA-type only)
6	DA-/N(for DA-type only)
7	DA+/Ls(for DA-type only)

Terminal Pin No. Assignment (TB2) :

Pin No.	Assignment
1	Vo+
2	Vo+
3	Vo-
4	Vo-
5	NTC
6	NTC
7	IADJ
8	IADJ
9	DIM+(for B-type only)
10	DIM-(for B-type only)

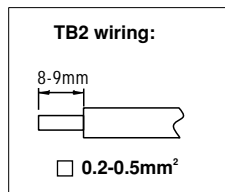
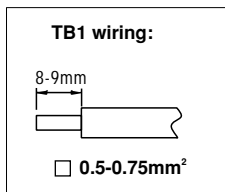
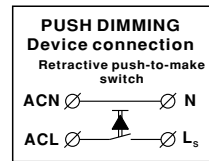

Installation Manual

Please refer to : <http://www.meanwell.com/manual.html>