

# ideal lux®

IDEAL LUX s.r.l.  
Via Taglio Destro 32  
30035 Mirano (VE) Italy  
www.ideal-lux.com

IDEAL LUX Warehouse  
Via delle Industrie, 8/D  
30036 Santa Maria di Sala (Venezia)  
8.00 - 12.00 / 13.30 - 17.00

# ideal lux®



REV 18/10/2024

## OZ AP On-Off

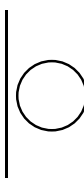

Lampada da parete  
Wall lamp  
Applique  
Wandleuchte  
Lámpara de pared  
Настенные светильники

LED

LED 26W / 220~240V 50/60Hz  
- 8021696253695 BIANCO 3000 K  
- 8021696269399 NERO 3000 K  
- 8021696269405 OTTONE 3000 K  
- 8021696342221 BIANCO 2700 K  
- 8021696342238 NERO 2700 K  
- 8021696342245 OTTONE 2700 K  
- 8021696342252 BIANCO 4000 K  
- 8021696342269 NERO 4000 K  
- 8021696342276 OTTONE 4000 K

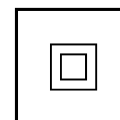
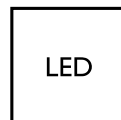
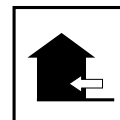
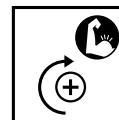
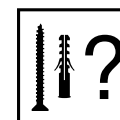
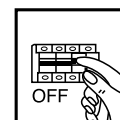
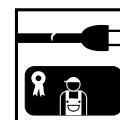
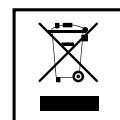
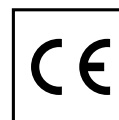
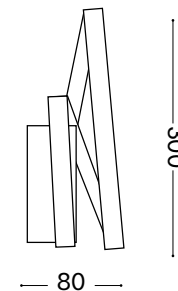
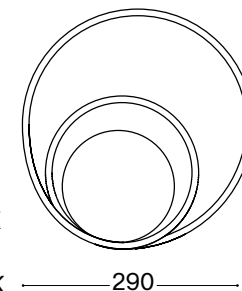

IDEAL LUX s.r.l.  
Via Taglio Destro 32  
30035 Mirano (VE) Italy  
www.ideal-lux.com

IDEAL LUX Warehouse  
Via delle Industrie, 8/D  
30036 Santa Maria di Sala (Venezia)  
8.00 - 12.00 / 13.30 - 17.00

ESEGUIRE LE OPERAZIONI SEGUENDO L'ORDINE PROGRESSIVO.  
 FOLLOW THE ASSEMBLY INSTRUCTIONS BY READING THE NUMERICAL PROGRESSION.

L'INSTALLAZIONE DI QUESTO APPARECCHIO DEVE ESSERE EFFETTUATA DA PERSONALE  
 QUALIFICATO. THE LIGHTING FITTING SHOULD BE INSTALLED BY A QUALIFIED ELECTRICIAN.

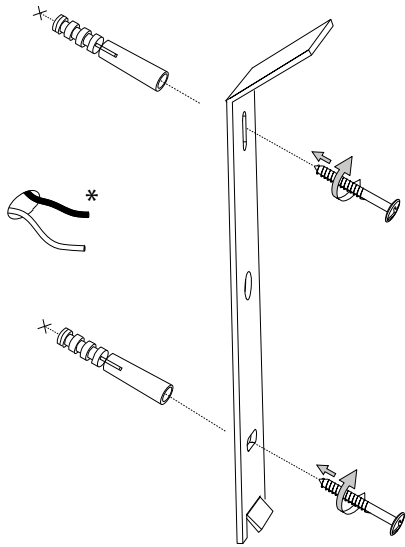
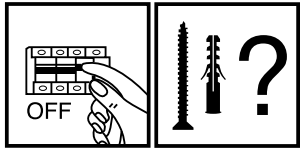

\* Attenzione, a seconda del sistema scelto (DALI/PUSH) il numero di cavi necessario all'installazione potrebbe variare. Affidarsi sempre a personale specializzato.  
 Warning, depending on the chosen system (DALI / PUSH) the number of wires required for installation may vary. Always rely on specialized electrician.

1

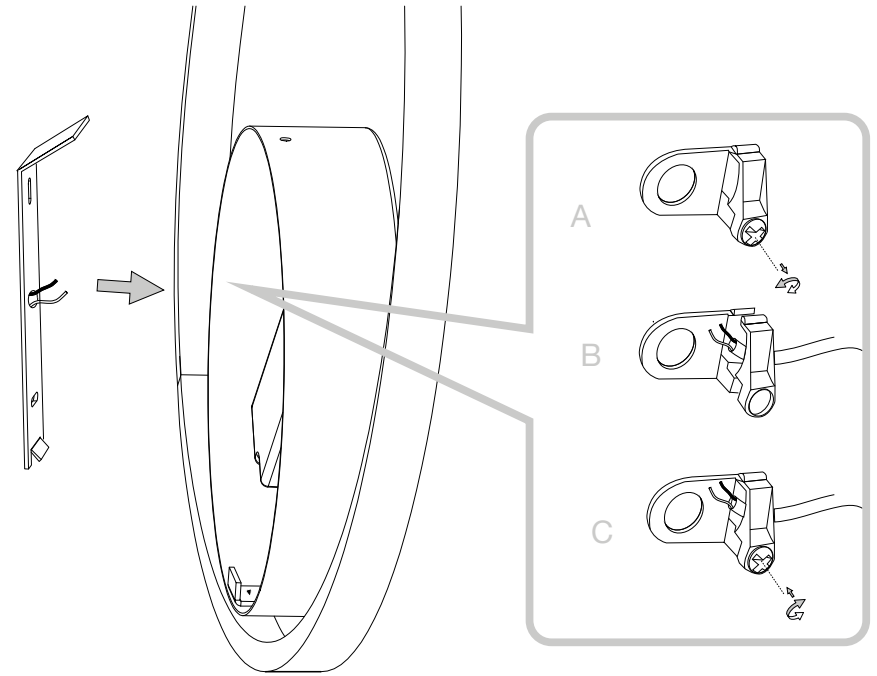

2

A x2

\*ATTENZIONE: mantenere il doppio isolamento con le guaine fornite  
 WARNING: preserve the double insulation with the sheaths provided

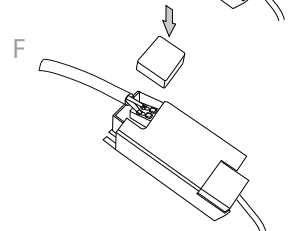
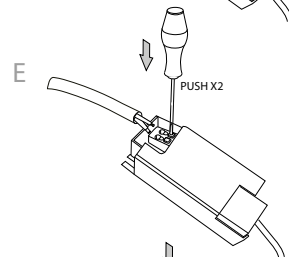
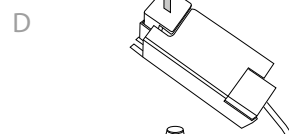
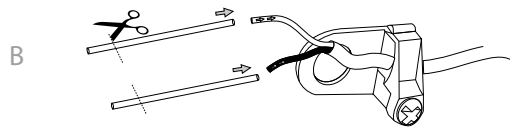

3

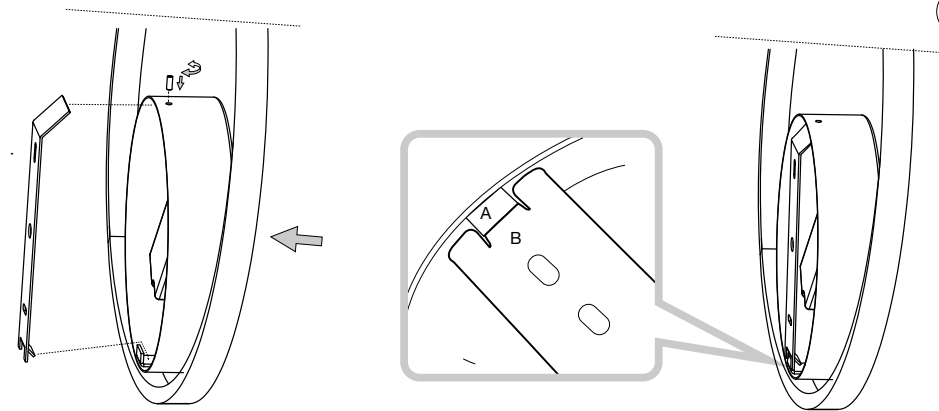

4

Assicurarsi che la linguetta sporgente del rosone (A) sia ben adesa alla piegatura sagomata della staffa di supporto (B)/  
 Make sure that the protruding tab of the ceiling cup (A) is well attached to the shaped fold of the support bracket(B).

LA SICUREZZA DI QUESTO APPARECCHIO È GARANTITA SOLO CON L'USO APPROPRIATO DI QUESTE ISTRUZIONI, PERTANTO È NECESSARIO CONSERVARLE.  
 THE SAFETY AND RELIABILITY ARE GUARANTEED ONLY WHEN INSTALLATION INSTRUCTIONS ARE PROPERLY FOLLOWED. PLEASE KEEP THIS INSTRUCTION SHEET FOR FUTURE REFERENCE.

**Sorgente luminosa non sostituibile: a fine vita l'apparecchio andrà smaltito / Non-replaceable light source: at the end of its life, the lamp must be disposed.**

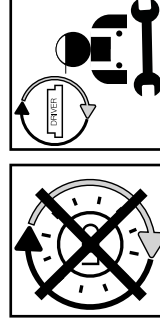

**Questo prodotto contiene una sorgente luminosa  
 di classe di efficienza energetica /  
 This product is provided with a light source  
 with efficiency energy class of:**

<b>EAN</b>	<b>Modello Sorgente Luminosa /Light Source Model</b>	<b>Classe di Efficienza Energetica / Energy Efficiency Class</b>	<b>Sorgente Luminosa / Light Source (mA)</b>	<b>Sorgente Luminosa / Light Source (V)</b>
8021696253695	OZ 14W 3000K MODULE	F	700 mA	36 V DC
8021696269399	OZ 14W 3000K MODULE	F	700 mA	36 V DC
8021696269405	OZ 14W 3000K MODULE	F	700 mA	36 V DC
8021696342221	OZ AP 2700K CRI90	E	700 mA	36 V DC
8021696342238	OZ AP 2700K CRI90	E	700 mA	36 V DC
8021696342245	OZ AP 2700K CRI90	E	700 mA	36 V DC
8021696342252	OZ AP 4000K CRI90	E	700 mA	36 V DC
8021696342269	OZ AP 4000K CRI90	E	700 mA	36 V DC
8021696342276	OZ AP 4000K CRI90	E	700 mA	36 V DC

## LEGENDA ICONE

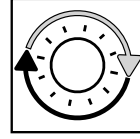

Sorgente luminosa sostituibile  
 dall'utente finale.  
 Replaceable light source  
 by an end-user.

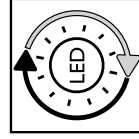

Sorgente LED luminosa sostituibile  
 dall'utente finale.  
 Replaceable LED light source  
 by an end-user.

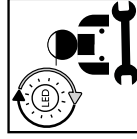

Sorgente luminosa sostituibile  
 esclusivamente da personale  
 autorizzato.  
 Replaceable light source  
 by authorized personnel only.

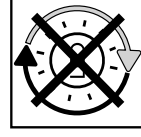

Sorgente luminosa non sostituibile.  
 Quando la sorgente arriverà a fine vita  
 dovrà essere sostituito l'intero apparecchio.  
 Non-replaceable light source.  
 Upon end of life of the light source,  
 the whole product will be replaced.

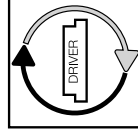

Dispositivo di alimentazione sostituibile  
 dall'utente finale.  
 Replaceable control gear  
 by an end-user.

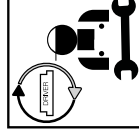

Dispositivo di alimentazione sostituibile  
 esclusivamente da personale autorizzato  
 Replaceable control gear  
 by authorized personnel only.

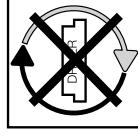

Dispositivo di alimentazione non sostituibile.  
 Quando il dispositivo di alimentazione  
 arriverà a fine vita  
 dovrà essere sostituito l'intero apparecchio.  
 Upon end of life of the control gear,  
 the whole product will be replaced.









- 18.** Jei apsauginis stiklas yra įskilęs arba sudužęs, pakeiskite jį nedelsiant ir naudodami tik nuostatus atitinkančias keičiamas dalis.
- 19.** Šviesos šaltinis su nekeičiamais šviesos diodais (LED). Neišmontuokite gaminio, nes diodai gali pažeisti akis. Nejmerkite į vandenį. Valykite naudodami drėgną šluostę ir venkite stiprių tirpiklių ir ploviklių naudojimo.
- 20.** Prietaise įdiegtas lydysis saugiklis. Jei šviestuvą neįsijungia, pakeiskite lydųj saugiklį.
- 21.** I-ą elektros saugos klasę užtikrina bendra izoliacija bei apsauginis laidininkas (žeminimas) prijungtas prie metalinės šviestuvo dalies. Privalomas žeminimas
- 22.** II-ą elektros saugos klasę užtikrina bendra izoliacija ir dviguba izoliacija arba sustiprinta izoliacija. Žeminimas nėra būtinas.
- 23.** III-ą elektros saugos klasę užtikrina labai žemos įtampos maitinimas (mažesnis, nei 50 voltų). Žeminimas nėra būtinas.
- 24.** Neapsaugotas.
- 25.** Apsaugotas nuo kietųjų kūnų, kurių skersmuo didesnis, nei 50 mm. patekimo.
- 26.** Apsaugotas nuo kietųjų kūnų, kurių skersmuo didesnis, nei 12 mm. patekimo.
- 27.** Apsaugotas nuo kietųjų kūnų, kurių skersmuo didesnis, nei 2,5 mm. patekimo.
- 28.** Apsaugotas nuo kietųjų kūnų, kurių skersmuo didesnis, nei 1 mm. patekimo.
- 29.** Apsaugotas nuo dulkių patekimo.
- 30.** Visiškai apsaugotas nuo dulkių patekimo.
- 31.** Neapsaugotas.
- 32.** Apsaugotas nuo statmenai krentančių vandens lašų patekimo.
- 33.** Apsaugotas nuo vandens lašų, kurių kritimo didžiausias kampas yra 15°, patekimo.
- 34.** Apsaugotas nuo lietaus.
- 35.** Apsaugotas nuo vandens pūslių.
- 36.** Apsaugotas nuo vandens čiurkšlių.
- 37.** Apsaugotas nuo stiprių vandens čiurkšlių.
- 38.** Apsaugotas nuo laikino įmerkimo.
- 39.** Apsaugotas nuo įmerkimo tam tikram laikui.
- 40.** Prietaisas neturi būti uždengiamas šilumą izoliuojančia medžiaga.
- 41.** Dėmesio, elektros smūgio pavojus.
- 42.** Nežiūrėkite tiesiai į šviesos šaltinį.