



Allgemeine Information

Technisch - Systeme

Ean	8021696268231
Artikel	LINUS SP 4000K WH
Installation	Systeme
Garantie	5 years
Bruttogewicht	2.92 kg
Volumen	0.01575 m ³

Technische Information

Nettogewicht	2.55 kg
Isolationsklasse	I
Schutzindex	IP20
Einhaltung	CE
Betriebstemperatur	0° ~ +40 °C
Dimmer	1, 1-10V
Leistung	100-240 V AC 50/60 Hz
Energieversorgung	In-built, included Replaceable (by qualified operators only), electronic
einschließlich Zubehör	Structure linear connector, Luminous corners

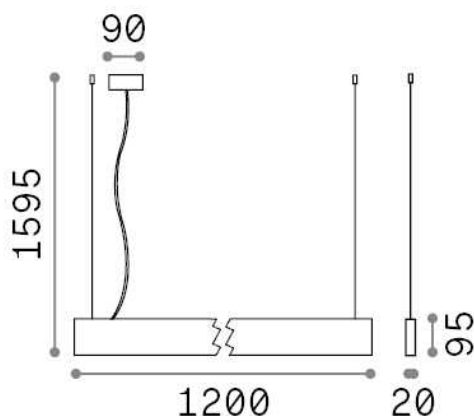

Quellinfo

Integrierte Quelle	Integrated LED module
Austauschbare Quelle	No
Leistung	32 W
Emissionen	Direct + Indirect
Maximaler Verbrauch	max 32,00 W
Merkmale LED	LED SMD
CCT LED	4000 K
Dauer LED (t. 25°C)	50000 h
CRI	> 80
SDCM	3
Lichtstrahlwinkel	104+104°
Lichtstrahlfluss	3600 lm
Nützlicher Lichtstrom	3190 lm
Photobiologisches Risiko	1
Standby-Leistung	< 0.50 W