

Allgemeine Information

Technisch - Systeme



Ean	8021696329512
Artikel	STICK TRACK DOUBLE 06W
Installation	Systeme
Garantie	5 years
Bruttogewicht	0.15 kg
Volumen	0.000593 m ³

Technische Information

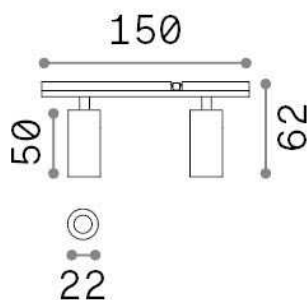

Nettogewicht	0.11 kg
Isolationsklasse	III
Schutzindex	IP20
Einhaltung	CE
Betriebstemperatur	0° ~ +40 °C
Dimmer	1, Phase-cut
Leistung	48 V DC
Energieversorgung	Required, remoted, not included Replaceable (by qualified operators only)
einschließlich Zubehör	Stick profile

Quellinfo

Integrierte Quelle	Integrated LED module
Austauschbare Quelle	Replaceable (by qualified operators only)
Leistung	6 W
Emissionen	Direct
Maximaler Verbrauch	max 6,00 W
Merkmale LED	LED COB BRIDGELUX
CCT LED	3000 K
Dauer LED (t. 25°C)	30000 h
CRI	> 90
Lichtstrahlwinkel	24°
Lichtstrahlfluss	550 lm
Nützlicher Lichtstrom	380 lm
Photobiologisches Risiko	1
Standby-Leistung	< 0.50 W