

General info

Technical - Systems



Ean	8021696345031
Item	STICK TRACK DOUBLE 10W 2700K
Installation	Systems
Warranty	5 years
Gross weight	0.2 kg
Volume	0.000593 m ³

Technical info

Net weight	0.1 kg
Insulation class	III
Protection index	IP20
Compliance	CE
Operating temperature	0° ~ +40 °C
Dimmer	1, Phase-cut
Power output	48 V DC
Power supply	Required, remoted, not included NO
Accessories not included	Stick profile

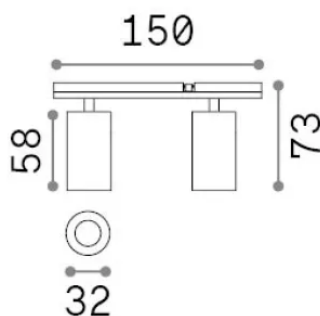

Source info

Integrated source	Integrated LED module
Replaceable source	No
Power	10 W
Emission	Direct
Max consumption	max 10 W
Features LED	LED COB BRIDGELUX
CCT LED	2700 K
Duration LED (t. 25°C)	50000 h
CRI	> 90
SDCM	3
Light beam	30°
Light beam flux	780 lm
Useful light flux	600 lm
Photobiological risk	1
Standby power	< 0.50 W