



Info generali

Tecnico - Sistemi

Indoor suspended dimmable linear fitting with integrated LED sources and direct/indirect light emission

Ean	8021696241968
Articolo	LINUS SP 3000K WH
Installazione	Sistemi
Garanzia	5 years
Peso lordo	2.92 kg
Volume	0.01575 m ³

Info tecniche e installative

Peso netto	2.55 kg
Classe di isolamento	I
Grado di protezione	IP20
Conformità	CE
Temperatura d'esercizio	0° ~ +40 °C
Dimmer	1, 1-10V
Alimentazione	100-240 V AC 50/60 Hz
Alimentatore	In-built, included Replaceable (by qualified operators only), electronic
Accessori non inclusi	Structure linear connector, Luminous corners

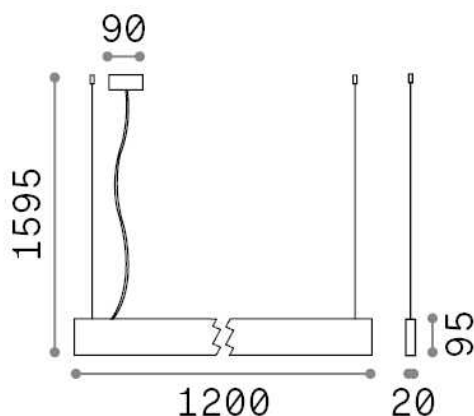

Info sorgente e prestazionali

Sorgente integrata	Integrated LED module
Sorgente sostituibile	No
Potenza	32 W
Emissione	Direct + Indirect
Consumo massimo	max 32,00 W
Caratteristiche LED	LED SMD
CCT LED	3000 K
Durata LED (t. 25°c)	50000 h
CRI	> 80
SDCM	3
Fascio luminoso	104+104°
Flusso sorgente	3450 lm
Flusso utile	3060 lm
Rischio fotobiologico	1
Potenza in stand-by	< 0.50 W